

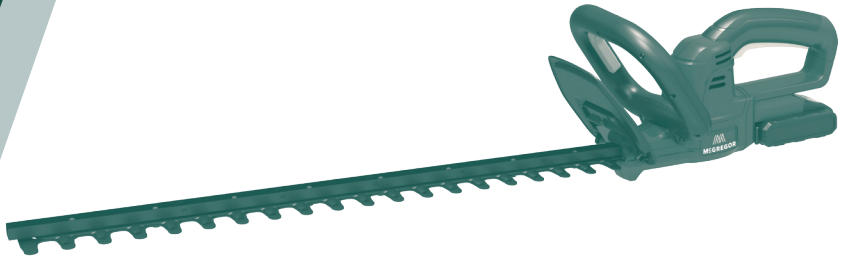

ORIGINAL INSTRUCTION MANUAL



McGregor 18V Cordless Hedge Trimmer

7509047/7409855(Model: MCH1845/MCH1851)

Important - Please read these instructions fully before starting assembly

These instructions contain important information that will help you get the best from your hedge trimmer, ensuring it is assembled correctly and safely. If you need help or have damaged or missing parts, call the Customer Helpline on 0345 605 2065

**AFTER SALES SUPPORT
0345 605 2065**

Contents

Safety information.....	3
In the box.....	14
Assemble.....	15
Prepare.....	15
Operate.....	18
Maintenance.....	19
Technical data.....	19
Accessories.....	20
Troubleshooting.....	21
Environmental protection.....	21
Getting help.....	22
Guarantee.....	22

Safety information

Important - Please read these instructions fully before starting assembly

Warning symbols

The following warning symbols appear throughout this assembly manual and indicate the appropriate safety measures you should take when assembling and operating the hedge trimmer.



This symbol indicates there is a danger of serious personal injury or death if you do not observe the warning.



Read operator's manual



Do not expose to rain

General safety



WARNING!

Keep this assembly manual in a safe place following assembly for reference at a later date.

Always ensure anyone intending to operate this hedge trimmer is fully conversant with the contents of this assembly manual prior to assembling, maintaining or operating the hedge trimmer.

Perform assembly operations as described in this manual.

Failure to observe this warning may lead

to serious injury, death, or damage to the hedge trimmer.

Always take care when removing the packaging to prevent damage to you or to the hedge trimmer.



IMPORTANT! Before assembling the hedge trimmer, check all the parts indicated in the manual are in the box. Inspect all the parts for signs of damage. Do not assemble the hedge trimmer if you observe any damaged components.

Safety information

Important - Please read these instructions fully before starting assembly

Personal safety



WARNING!

Only operate the grass trimmer if you are wearing the correct Personal Protective Equipment (PPE) as described in the following warnings.

Warning symbols

The following warning symbols appear throughout this assembly manual and indicate the appropriate safety measures you should take when assembling and operating the Hedge Trimmer.



Read operator's manual



Warning



Wear ear protection



Wear eye protection



Wear dust mask



Do not expose to moisture



For indoor use only

Safety information

Important - Please read these instructions fully before starting assembly

Warning symbols



Read the operator's manual.

T 2A

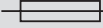

Fuse



Positive terminal



Negative terminal



Double insulation



Li-ion battery. This product has been marked with a symbol relating to 'separate collection' for all battery packs and battery pack. It will then be recycled or dismantled in order to reduce the impact on the environment. Battery packs can be hazardous for the environment and for human health since they contain hazardous substances.



Batteries may enter water cycle if disposed improperly, which can be hazardous for ecosystem. Do not dispose of waste batteries as unsorted municipal waste.



Do not burn



Waste electrical products must not be disposed of with household waste. Please recycle where facilities exist. Check with your local authorities or retailer for recycling advice.

Safety information

Important - Please read these instructions fully before starting assembly

General power tool safety warnings



WARNING!

Read all safety warnings and all instructions. Failure to follow the warnings and instructions may result in electric shock, fire and/or serious injury.

Save all warnings and instructions for future reference.

The term “power tool” in the warnings refers to your mains-operated (corded) power tool or battery-operated (cordless) power tool.

1) Work area safety

- a) Keep work area clean and well lit. Cluttered or dark areas invite accidents.
- b) Do not operate power tools in explosive atmospheres, such as in the presence of flammable liquids, gases or dust. Power tools create sparks which may ignite the dust or fumes.
- c) Keep children and bystanders away while operating a power tool. Distractions can cause you to lose control.

2) Electrical safety

- a) Power tool plugs must match the outlet. Never modify the plug in any way. Do not use any adapter plugs with earthed (grounded) power tools. Unmodified plugs and matching outlets will reduce risk of electric shock.
- b) Avoid body contact with earthed or grounded surfaces, such as pipes, radiators, ranges and refrigerators. There is an increased risk of electric shock if your body is earthed or grounded.
- c) Do not expose power tools to rain or wet conditions. Water entering a power tool will increase the risk of

Safety information

Important - Please read these instructions fully before starting assembly

General power tool safety warnings

electric shock.

- d) Do not abuse the cord. Never use the cord for carrying, pulling or unplugging the power tool. Keep cord away from heat, oil, sharp edges or moving parts. Damaged or entangled cords increase the risk of electric shock.
- e) When operating a power tool outdoors, use an extension cord suitable for outdoor use. Use of a cord suitable for outdoor use reduces the risk of electric shock.
- f) If operating a power tool in a damp location is unavoidable, use a residual current device (RCD) protected supply. Use of an RCD reduces the risk of electric shock.

3) Personal safety

- a) Stay alert, watch what you are doing and use common sense when operating a power tool. Do not use a power tool while you are tired or under the influence of drugs, alcohol or medication. A moment of inattention while operating power tools may result in serious personal injury.
- b) Use personal protective equipment. Always wear eye protection. Protective equipment such as dust mask, non-skid safety shoes, hard hat, or hearing protection used for appropriate conditions will reduce personal injuries.
- c) Prevent unintentional starting. Ensure the switch is in the off-position before connecting to power source and/or battery pack, picking up or carrying the tool. Carrying power tools with your finger on the switch or energising power tools that have the switch on invites accidents.
- d) Remove any adjusting key or wrench before turning the power tool on. A wrench or a key left attached to a rotating part of the power tool may result in personal injury.
- e) Do not overreach. Keep proper footing and balance at all times. This enables better control of the power tool in unexpected situations.

Safety information

Important - Please read these instructions fully before starting assembly

General power tool safety warnings

- f) Dress properly. Do not wear loose clothing or jewellery. Keep your hair, clothing and gloves away from moving parts. Loose clothes, jewellery or long hair can be caught in moving parts.
 - g) If devices are provided for the connection of dust extraction and collection facilities, ensure these are connected and properly used. Use of dust collection can reduce dust-related hazards.
- 4) Power tool use and care
- a) Do not force the power tool. Use the correct power tool for your application. The correct power tool will do the job better and safer at the rate for which it was designed.
 - b) Do not use the power tool if the switch does not turn it on and off. Any power tool that cannot be controlled with the switch is dangerous and must be repaired.
 - c) Disconnect the plug from the power source and/or the battery pack from the power tool before making any adjustments, changing accessories, or storing power tools. Such preventive safety measures reduce the risk of starting the power tool accidentally.
 - d) Store idle power tools out of the reach of children and do not allow persons unfamiliar with the power tool or these instructions to operate the power tool. Power tools are dangerous in the hands of untrained users.
 - e) Maintain power tools. Check for misalignment or binding of moving parts, breakage of parts and any other condition that may affect the power tool's operation. If damaged, have the power tool repaired before use. Many accidents are caused by poorly maintained power tools.
 - f) Keep cutting tools sharp and clean. Properly maintained cutting tools with sharp cutting edges are less likely to bind and are easier to control.

Safety information

Important - Please read these instructions fully before starting assembly

General power tool safety warnings

- g) Use the power tool, accessories and tool bits etc. in accordance with these instructions, taking into account the working conditions and the work to be performed. Use of the power tool for operations different from those intended could result in a hazardous situation.
- 5) Battery tool use and care
- a) Recharge only with the charger specified by the manufacturer. A charger that is suitable for one type of battery pack may create a risk of fire when used with another battery pack.
- b) Use power tools only with specifically designated battery packs. Use of any other battery packs may create a risk of injury and fire.
- c) When battery pack is not in use, keep it away from other metal objects, like paper clips, coins, keys, nails, screws or other small metal objects, that can make a connection from one terminal to another. Shorting the battery terminals together may cause burns or a fire.
- d) Under abusive conditions, liquid may be ejected from the battery; avoid contact. If contact accidentally occurs, flush with water. If liquid contacts eyes, additionally seek medical help. Liquid ejected from the battery may cause irritation or burns.
- 6) Service
- a) Have your power tool serviced by a qualified repair person using only identical replacement parts. This will ensure that the safety of the power tool is maintained.

Safety information

Important - Please read these instructions fully before starting assembly

Hedge trimmer safety warnings

1. Keep all parts of the body away from the cutter blade. Do not remove cut material or hold material to be cut when blades are moving. Make sure the switch is off when clearing jammed material. A moment of inattention while operating the hedge trimmer may result in serious personal injury.
2. Carry the hedge trimmer by the handle with the cutter blade stopped. When transporting or storing the hedge trimmer always fit the cutting device cover. Proper handling of the hedge trimmer will reduce possible personal injury from the cutter blades.
3. Hold the power tool by insulated gripping surfaces only, because the cutter blade may contact hidden wiring. Cutter blades contacting a “live” wire may make exposed metal parts of the power tool “live” and could give the operator an electric shock.
4. Check the hedge for foreign objects, e.g. wire fences.
5. Use both hands when operating the hedge trimmer. Using one hand could cause loss of control and result in serious personal injury.

General safety warnings for your battery charger



WARNING!

Read all safety warnings and all instructions. Failure to follow the warnings and instructions may result in electric shock, fire and/or serious injury.

Save all warnings and instructions for future reference. This appliance can be used by children aged from 8 years and above and persons with reduced physical, sensory or mental capabilities or lack of experience and knowledge if they have been given supervision or

Safety information

Important - Please read these instructions fully before starting assembly

General safety warnings for your battery charger

instruction concerning use of the appliance in a safe way and understand the hazards involved. Children shall not play with the appliance. Cleaning and user maintenance shall not be made by children without supervision. If the supply cord is damaged, it must be replaced by the manufacturer, its service agent or similarly qualified persons in order to avoid a hazard.

Additional safety instructions for your battery charger

1. Before charging, read the instructions.
2. Do not charge a leaking battery.
3. Do not use chargers for works other than those for which they are designed.
4. Before charging, ensure your charger is matching the local AC supply.
5. For indoor use, or do not expose to rain.
6. The charging device must be protected from moisture.
7. Do not use the charging device in the open.
8. Do not short out the contacts of battery or charger.
9. Respect the polarity “+/-“ when charging.
10. Do not open the unit and keep out of the reach of children.
11. Do not charge the batteries of other manufactures or ill-suited models.
12. Ensure that the connection between the battery charger and battery is correctly positioned and is not obstructed by foreign bodies.
13. Keep battery charger’s slots are free of foreign objects and protect against dirt and humidity. Store in a dry and frost-free place.
14. When charging batteries, ensure that the battery charger is in a well-ventilated area and away from

Safety information

Important - Please read these instructions fully before starting assembly

Additional safety instructions for your battery charger

inflammable materials. Batteries can get hot during charging. Do not overcharge any batteries. Ensure that batteries and chargers are not left unsupervised during charging.

15. Do not recharge non-rechargeable batteries, as they can overheat and break.
16. Longer life and better performance can be obtained if the battery pack is charged when the air temperature is between 18°C and 24°C. Do not charge the battery pack in air temperatures below 4.5°C, or above 40.5°C. This is important as it can prevent serious damage to the battery pack.
17. Charge only battery pack of the same model provided by manufacturer and of models recommended by manufacturer.

Safety warnings for battery pack

- a) Do not dismantle, open or shred cells or battery pack.
- b) Do not short-circuit a battery pack. Do not store battery packs haphazardly in a box or drawer where they may short-circuit each other or be short-circuited by conductive materials. When battery pack is not in use, keep it away from other metal objects, like paper clips, coins, keys, nails, screws or other small metal objects, that can make a connection from one terminal to another. Shorting the battery terminals together may cause burns or a fire.
- c) Do not expose battery pack to heat or fire. Avoid storage in direct sunlight.
- d) Do not subject battery pack to mechanical shock.
- e) In the event of battery leaking, do not allow the liquid to come into contact with the skin or eyes. If contact has been made, wash the affected area with copious

Safety information

Important - Please read these instructions fully before starting assembly

Safety warnings for battery pack

- amounts of water and seek medical advice.
- f) Seek medical advice immediately if a cell or battery pack has been swallowed.
 - g) Keep battery pack clean and dry.
 - h) Wipe the battery pack terminals with a clean dry cloth if they become dirty.
 - i) Battery pack needs to be charged before use. Always refer to this instruction and use the correct charging procedure.
 - j) Do not maintain battery pack on charge when not in use.
 - k) After extended periods of storage, it may be necessary to charge and discharge the battery pack several times to obtain maximum performance.
 - l) Battery pack gives its best performance when it is operated at normal room temperature ($20^{\circ}\text{C} \pm 5^{\circ}\text{C}$).
 - m) When disposing of battery packs, keep battery packs of different electrochemical systems separate from each other.
 - n) Recharge only with the charger specified by POSITEC. Do not use any charger other than that specifically provided for use with the equipment. A charger that is suitable for one type of battery pack may create a risk of fire when used with another battery pack.
 - o) Do not use any battery pack which is not designed for use with the equipment.
 - p) Keep battery pack out of the reach of children.
 - q) Retain the original product literature for future reference.
 - r) Remove the battery from the equipment when not in use.
 - s) Dispose of properly.

In the box

Parts

- | | |
|-----------------------------------|-------------------------------|
| 1 Blade | 6 Battery pack |
| 2 Safety guard | 7 Blade sheath |
| 3 Front handle with safety switch | 8 Battery charger |
| 4 Rear handle | 9 Battery pack release button |
| 5 On/off switch | 10 Instruction manual |

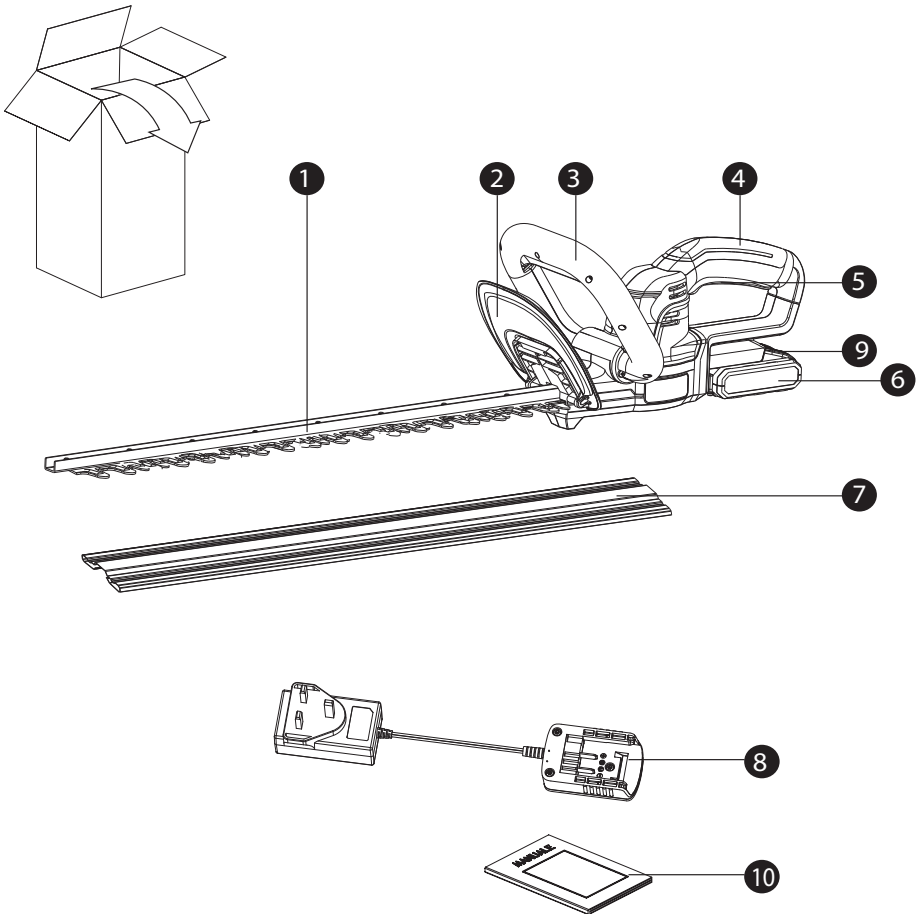

Assemble

Assembling instructions

The hedge trimmer has been already assembled, You needn't to assemble.

Prepare

Preparing instructions



Always take care when removing the packaging to prevent damage to you or to the hedge trimmer.



IMPORTANT! Before assembling the hedge trimmer, check all the parts indicated in the manual are in the box. Inspect all the parts for signs of damage. Do not assemble the hedge trimmer if you observe any damaged components.



NOTE: Before using the tool, read the instruction book carefully.

Remove all parts of the hedge trimmer from the box and carefully remove all packaging. Take care not to lose any instructions which may be attached to the tool, these provide important information which will be required while assembling the hedge trimmer.

1. TO CHARGE THE BATTERY (See Fig. A)

Chargers and batteries are specifically designed to work together. Do not attempt to use batteries with any other charger than that specified in these instructions.

Important notes for charging the battery:

In a warm environment or after heavy use, the battery pack may become too hot to permit charging. Allow time for the battery to cool down before recharging.

BEFORE USING YOUR CORDLESS HEDGE TRIMMER, YOU MUST FULLY CHARGE THE BATTERY

Your battery pack is UNCHARGED and you must fully charge before use.

HOW TO CHARGE THE BATTERY:

A discharged battery at normal ambient temperature will take approximately 3-5 hours to reach full charge.

⚠ WARNING: When battery charge runs out after continuously use or exposure to direct sunlight or heat, allow time for the battery pack to cool down before re-charging to achieve the full charge.

CHARGING INDICATOR

Light	Status
Red on	Charging
Green on	Fully Charged

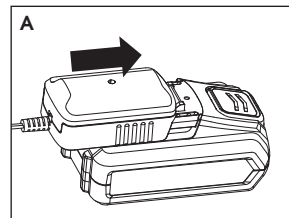

Prepare

Preparing instructions

2. TO REMOVE OR INSTALL BATTERY PACK (See B1, B2)

Depress the Battery pack release button to release battery pack from your hedge trimmer. After recharging, insert the battery pack into hedge trimmer's battery port. A simple push and slight pressure will be sufficient.

⚠ WARNING! DO NOT USE THE PRODUCT WITHOUT ATTACHING THE GUARD.

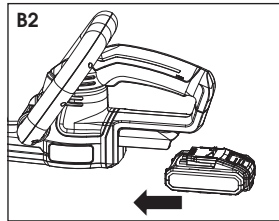
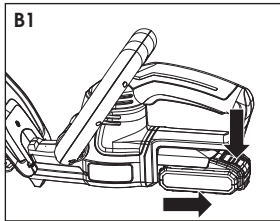

3. BEFORE STARTING YOUR HEDGE TRIMMER

Remove blade sheath as illustrated in Fig C.

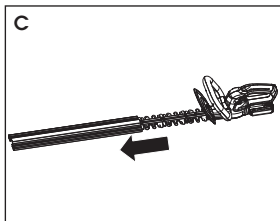

4. TO START YOUR HEDGE TRIMMER (See D)

Your trimmer is equipped with two switch levers, safety switch and On/Off switch. Both switch levers need to be pressed for the hedge trimmer to start. Depress and hold safety handle switch on front handle and press on/off switch on rear handle.

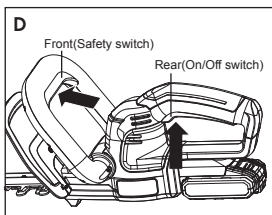

TO STOP YOUR HEDGE TRIMMER

Move hedge trimmer away from cutting area before stopping.

To stop, release either the safety handle switch or On/Off switch, the Trimmer will stop almost immediately.

⚠ WARNING! If any parts are missing, damaged or broken, do not operate your hedge trimmer until all damaged parts have been replaced or repaired. Failure to do so could result in serious personal injury.

Prepare

Preparing instructions

PAY ATTENTION TO USE YOUR HEDGE TRIMMER

Inspect the area to be cut before each use, remove objects which can be thrown or become entangled in the cutting blades.

Always hold the Hedge trimmer with both hands and with the blade away from you before turning it on.

When trimming new growth, use a wide sweeping action so that the stems are fed directly into the blade.

Allow the cutting blades to reach full speed before entering the material to be cut.

Always work in the direction going away from people and solid objects such as walls, large stones, trees, vehicles etc.

If the blade jam, immediately stop the Hedge trimmer. Remove the battery pack and clear the jammed things from the cutting blade.

Wear gloves when trimming thorny or prickly growth.

Move the Hedge trimmer to feed the branches directly into the blade cutting edges.

Do not try to cut stems that are too large to feed into the cutting blade.

Operate

Operating instructions

1. TOP EDGING (See Fig E)

Use a wide sweeping motion. A slight downward slant of the cutting blades in the direction of motion gives the best cutting results.

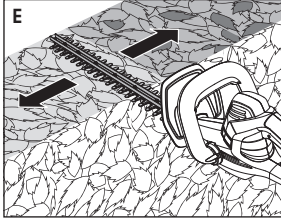

2. SIDE EDGING(See Fig F)

When trimming the sides of the hedge, begin at the bottom and cut upwards. You should taper the hedge inward at the top. This shape will expose more of the hedge, resulting in a more uniform growth.

⚠ WARNING: Check extension cords before each use. If damaged replace immediately. Never use your tool with a damaged cord since touching the damaged area could cause electrical shock resulting in serious injury.

If the supply cord is damaged, it should be replaced by a local approved service centre.

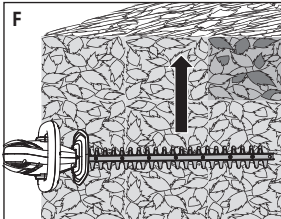

Maintenance

Maintenance

 **WARNING:** Remove the battery before carrying out any adjustment, servicing or maintenance.

- 1) Never use water to cleaning the unit.
- 2) Always clean the hedge trimmer immediately after use. Brush the blade using a stiff nylon brush to remove any debris.
- 3) Always store the unit in a dry place.
- 4) Inspect the hedge trimmer before each use.
- 5) Have the unit professionally repaired if any damage occurs.
- 6) The blade rail should be cleaned and treated with fine lubricating oil after each use.
- 7) Use the blade sheath for transportation and storage.

Technical data

Technical data table

Hedge trimmer	MCH1851	MCH1845
Voltage	18V ---	
No load speed	2800/min	
Cutting width	16mm	
Cutting length	510 mm	450 mm
Machine weight	2.1kg	2.0kg
<hr/>		
Charger	ACG318G2	
Charger input	100-240V ~ 50/60Hz	
Charger output	20V --- 0.5A	
Charging time	3-5 hrs	
<hr/>		
Battery pack	ABP118W2	
Battery type	Lithium-Ion	
Battery capacity	18V --- 2.0Ah, 36Wh	

Technical data

Noise technical data

A weighted sound pressure
 $K_{pA}=3$ dB (A)
A weighted sound power
Wear ear protection.

$L_{pA} = 65.7$ dB(A)

$L_{wA} = 79.8$ dB(A)



VIBRATION INFORMATION

Typical weighted vibration $a_n = 2.207$ m/s², uncertainty $K= 1.5$ m/s²

⚠ WARNING: The vibration emission value during actual use of the power tool can differ from the declared value depending on the ways in which the tool is used dependant on the following examples and other variations on how the tool is used:

How the tool is used and the materials is cut or drilled.

The tool being in good condition and well maintained

To use the correct accessory for the tool and ensuring it is sharp and in good condition.

The tightness of the grip on the handles and any anti vibration accessories are used.

And the tool is being used as intended by its design and these instructions.

This tool may cause hand-arm vibration syndrome if its use is not adequately managed

⚠ WARNING: To be accurate, an estimation of exposure level in the actual conditions of use should also take account of all parts of the operating cycle such as the times when the tool is switched off and when it is running idle but not actually doing the job. This may significantly reduce the exposure level over the total working period.

Help to minimize your vibration exposure risk.

ALWAYS use sharp chisels, drills and blades

Maintain this tool in accordance with these instructions and keep well lubricated (where appropriate)

If the tool is to be used regularly then invest in anti vibration accessories.

Plan your work schedule to spread any high vibration tool use across a number of days.

Accessories

	MCH1851	MCH1845
Safety guard (installed on machine)	1	1
Blade sheath (installed on machine)	1	1
Charger	1	1
Battery pack	1	1

Troubleshooting

General troubleshooting

The following chart lists problem symptoms, possible causes and corrective action, if your electric hedge trimmer does not operate properly. If these do not identify and correct the problem, contact your service agent.

⚠ WARNING: Always switch the product off, disconnect it from power supply and let the product cool down before performing inspection, maintenance and cleaning work!

Problem	Possible cause	Solution
Hedge trimmer does not operate	1.1 Battery discharged 1.2 Battery not fully connected	1.1 Recharge battery; also see "Charging The Battery" 1.2 Ensure the battery pack release button is fully locked
Hedge trimmer operates intermittently	2.1 Internal wiring damaged 2.2 On/Off switch defective	2. Contact Helpline
Motor runs but blades remain stationary	3. Internal fault	3. Contact Helpline
Cutting blade hot	4.1 Cutting blade dull 4.2 Cutting blade is damaged 4.3 Too much friction, due to lack of lubricant	4.1 Have blade sharpened 4.2 Have blade inspected/over-hauled 4.3 Apply lubricant spray
Cutting time per battery charge too low	5.1 Too much friction, due to lack of lubricant 5.2 Blade needs cleaning 5.3 Battery not fully charged	5.1 Apply lubricant spray 5.2 Clean blade 5.3 Recharge battery; also see "Charging The Battery"
The blades are running slow	6.1 Battery discharged 6.2 Battery stored outside of battery temperature	6.1 Recharge battery; also see "Charging The Battery" 6.2 Allow battery to warm naturally to room temperature (within battery operating temperature 10–45 °C)
Battery charge indicator(a) does not light up	7.1 Mains plug of battery charger not plugged in (properly) 7.2 Socket outlet, mains cable or battery charger defective	7.1 Insert mains plug (fully) into the socket outlet 7.2 Contact Service Agent

Environmental protection



This product has been marked with a symbol relating to removing electric and electronic waste. This means that this product shall not be discarded with household waste but that it shall be returned to a collection system which conforms to the European Directive 2002/96/CE. It will then be recycled or dismantled in order to reduce the impact on the environment. Electric and electronic equipment can be hazardous for the environment and for human health since they contain hazardous substances.

Getting help

Customer helpline 0345 605 2065

Guarantee

Dear Customer,

In the unlikely event that your device develops a fault, please contact our Customer service department on the telephone number shown below.

1. These guarantee terms cover additional guarantee rights and do not affect your statutory warranty rights. Claims must be accompanied by Proof of Purchase. This must be in the form of a Sales receipt or Bank statement and must show that the product has been purchased within 2 years prior to the claim, from the retailer that it was originally sold to.
2. Our guarantee covers problems caused by material or manufacturing defects, and will result in the repair of these defects or replacement of the device with a like for like or similar article. Please note that our devices have not been designed for use in commercial, trade or industrial applications. Consequently, the guarantee is invalidated if the equipment is used in commercial, trade or industrial applications or for other equivalent activities.
3. The following are also excluded from our guarantee :
 - A. Faults due to accidents, customer misuse or unauthorized repairs
 - B. Consumable Parts such as detergent bottle, patio cleaner, jet lance, fix brush and nozzle pin.
 - C. Failure due to lack of routine maintenance.
 - D. Failure as a result of not using the equipment in accordance with the manual and safety instructions
 - E. The adjustment of cables, drives belts or recoil starters.
4. The guarantee is valid for a period of 2 years starting from the purchase date of the device. Guarantee claims should be submitted before the end of the guarantee period within two weeks of the defect being noticed. No guarantee claims will be accepted after the end of the guarantee period. The original guarantee period remains applicable to the device even if repairs are carried out or parts are replaced. In such cases, the work performed or parts fitted will not result in an extension of the guarantee period, and no new guarantee will become active for the work performed or parts fitted. This also applies when an on-site Service is used.
5. Please keep your sales receipt in a safe place. If is covered by our guarantee your device will either be repaired under the terms of guarantee or we will send you a replacement device. This device may be re-conditioned or like for like replacement .

