

PRESSURE FIT PET GATE EXTENTION PACK

care & instruction manual

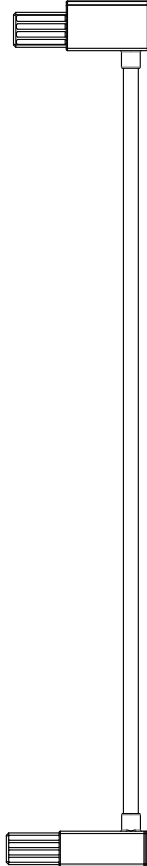

IMPORTANT

KEEP THESE INSTRUCTIONS FOR FUTURE REFERENCE

Cat.No.:6259350

IMPORTANT! READ AND FOLLOW THESE INSTRUCTIONS AND REFER TO INSTRUCTIONS OF CAT NO. 9559428 CAREFULLY AND KEEP FOR FUTURE REFERENCE

Introduction

Please read the instructions thoroughly to ensure proper installation.

Please immediately inspect your safety gate upon receipt. If you see any damage, or additional parts are required for this gate, do not assemble gate and please go to back page of the instruction booklet for website or Consumer Relations Representative information. We recommend that you carry out the installation away from young children as some of the smaller components may present a choking hazard when loose.

Important Information

There is a gap between your gate frame and handle. This is not a defect. The gap on your gate will close once it is properly mounted. Please check the gate on a regular basis to ensure gate and parts are all in proper working order. If the gate is used at the bottom of the stairs, please place towards the front of the lowest stair. Ensure the gate is attached between two clean and solid surfaces. Ensure appropriate fixings are used for drywall, wood, brick, etc. If wall plugs are provided with the gate and do not secure to the wall satisfactorily, consult with a hardware store for your proper wall plug application. If additional parts are required for this gate, please go to back page of the instruction booklet for website or Consumer Relations Representative information. Do not use this gate at the bottom of stairs without using all four wall cups. For maximum safety, use 4 wall cups with sticky pads and screws provided when installing the gate in all locations.

Disclaimer

Any safety gate which has been subjected to misuse, abuse, abnormal use, excessive wear and tear, improper assembly, negligence, environmental exposure, alteration or accident, or has had its serial number altered or removed invalidates any and all claims against the manufacturer. Any damage to property during installation of your safety gate is the sole responsibility of the end user.

WARNING!

- **WARNING**– Never use with a child able to climb over or dislodge the gate or enclosure.
 - **WARNING**– Do not use the safety barrier if any components are damaged or missing.
 - **WARNING**– Incorrect installation can be dangerous.
 - **WARNING**– The safety barrier must not be fitted across windows or similar openings.
 - **WARNING**– **Never use without wall cups.**
 - **WARNING**– Always check that the barrier is properly closed.
 - **WARNING**– Don't install a second gate above the first as there is a risk of serious injury or death.
 - **WARNING**– Be careful when stepping over the bottom bar.
-
- Check that the safety barrier is correctly closed.
It is manual closing system.
 - To prevent serious injury or death, securely install gate or enclosure. And use according to manufacturer's instructions.
 - Safety barrier should be checked regularly to ensure it is secure and functioning in accordance with these instructions.
 - Additional or replacement parts should only be obtained from the manufacturer or distributor.
 - Adjust to fit opening between 82cm and 95cm with pressure fit gate Cat No. 9559428.
 - Do not allow older children to climb on or over the gate as this can result in an accident.
-
- Safety barrier is suitable for use with children up to 24 months of age.
 - This product will not necessarily prevent all accidents. Never leave child unattended.
 - This safety barrier complies with EN1930:2011.
 - This safety barrier is for indoor domestic use only.
 - To clean: Use mild soap and wipe with a damp cloth.
 - Adult assembly required.
 - Install according to manufacturer's instructions.
 - Don't use the safety barrier at the top of stairs.

Available Extensions

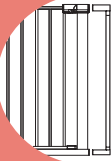

Please install the 7cm extension in the hinge side, not the switch side.

Extensions Information

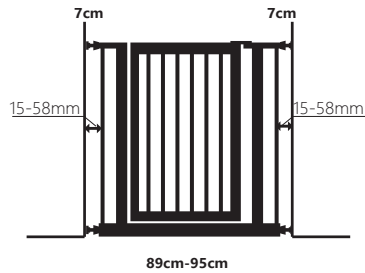
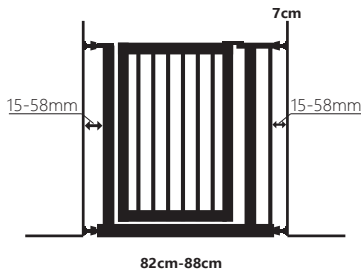

Take out the plastic bolt plugs from which pre-assembled on the original 9559428 pet gate.

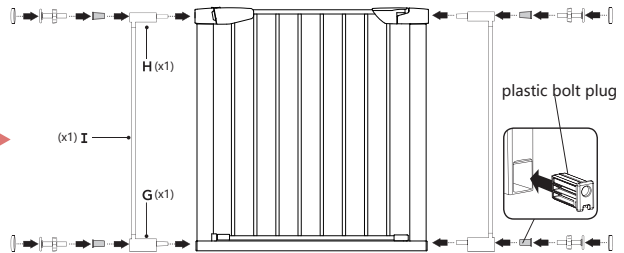
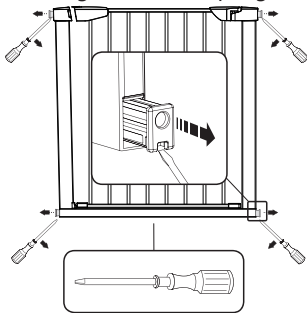

Put on one or two the extension bar according to the door width. insert the plastic bolt plugs into the extension bar. then follow the Installation Manual of the original 9559428 pet gate.

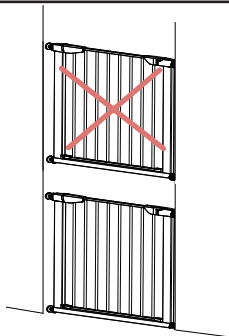

WARNING

Don't install a second gate above the first as there is a risk of serious injury or death.

Customer care

Your child's safety is your responsibility

If you have a problem with this product or require replacement parts, please contact your nearest Argos store or telephone the Argos Customer Care Team on 0345 640 2020

Alternatively write to:

Customer Care Team

Produced in China. Sainsbury's Supermarkets Ltd. 33 Holborn, London, EC1N 2HT. Sainsbury's (NI) Ltd, Forestside Shopping Centre, Upper Galwally, Belfast, United Kingdom, BT8 6FX. Argos Limited, 489-499 Avebury Boulevard, Milton Keynes, MK9 2NW. Argos (N.I.) Ltd, Forestside Shopping Centre, Upper Galwally, Belfast, United Kingdom, BT8 6FX. Argos Distributors (Ireland) Limited, Unit 7, Ashbourne Retail Park, Ballybin Road, Ashbourne, County Meath, Ireland.