

Matrix Glass / Metal Entertainment Unit

Assembly Instructions - Please keep for future reference

610/8009

609/0698

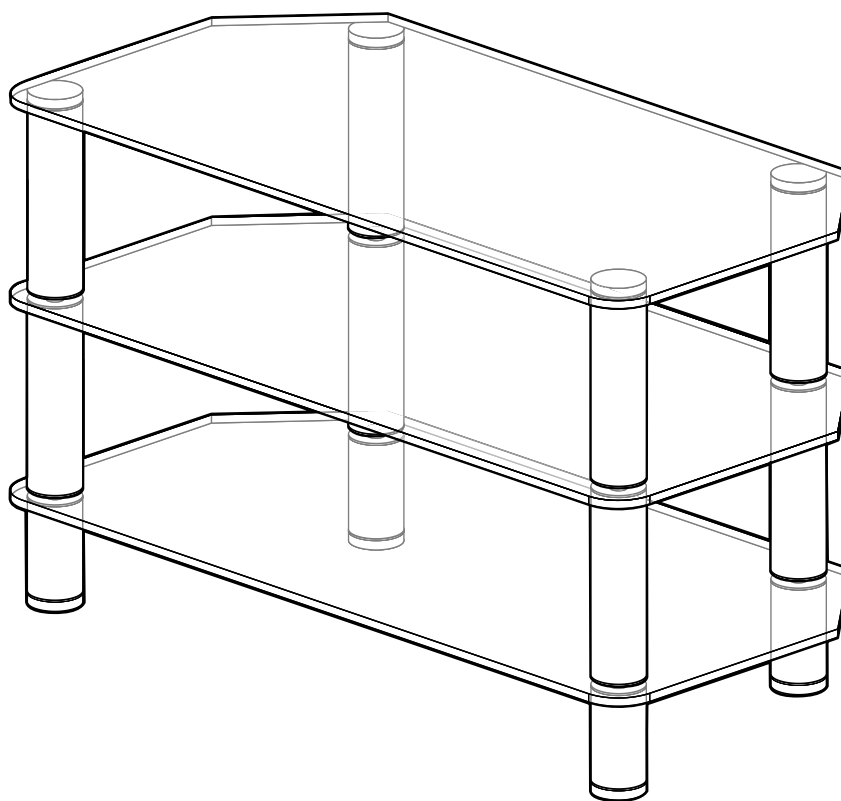

Dimensions

Width - 80cm

Depth - 40cm

Height - 50cm

Important - Please read these instruction fully before starting assembly

If you need help or have damaged or missing parts, call the Customer Helpline: 08456 400800



Safety and Care Advice

Important - Please read these instructions fully before starting assembly

- Check you have all the components and tools listed on pages 2.
- Remove all fittings from the plastic bags and separate them into their groups.
- Keep children and animals away from the work area, small parts could choke if swallowed.
- Make sure you have enough space to layout the parts before starting.

- Do not stand on the product, this could cause damage.
- Assemble the item as close to its final position (in the same room) as possible.
- Assemble on a soft level surface to avoid damaging the unit or your floor.
- Parts of the assembly will be easier with 2 people.

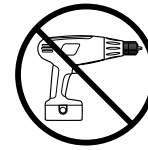

- We do not recommend the use of power drill/drivers **for inserting screws**, as this could damage the unit. Only use hand screwdrivers.
- Dispose of all packaging carefully and responsibly.

Care and maintenance

- Only clean using a damp cloth and mild detergent, do not use bleach or abrasive cleaners.
- From time to time check that there are no loose screws on this unit.
- This product should not be discarded with household waste. Take to your local authority waste disposal centre.

Keep These Instructions For Future Reference

- This product complies with BS EN14749:2005
- Argos plc
489-499 Avebury Boulevard
Central Milton Keynes
MK9 2NW
- Batch No./Date of manufacture:

Warning

- Do not place very hot or very cold items against or in close proximity to glass surfaces unless an adequately thick insulating material is used to prevent such items from coming into contact with the glass.
- Do not sit or stand upon the glass surface(s).
- If a glass component is chipped or broken, stop using the product and consult the manufacturer or supplier.
- Do not use the glass as a chopping surface. Do not strike the glass with hard or pointed items.

Components - Panels

Please check you have all the panels listed below



1 Metal rod x 4
(M8 x 48.5cm)

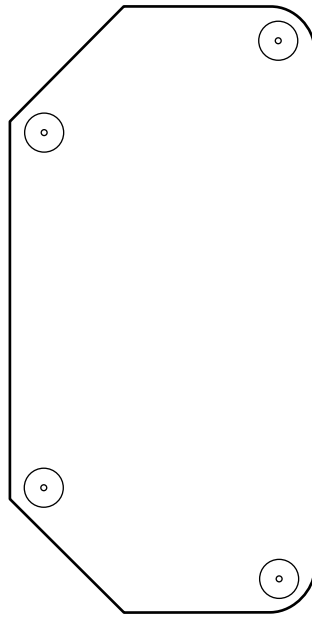

2 Top glass (80 x 40cm)

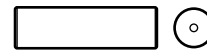

3 Metal tube x 8
(5.08 x 18.2cm)

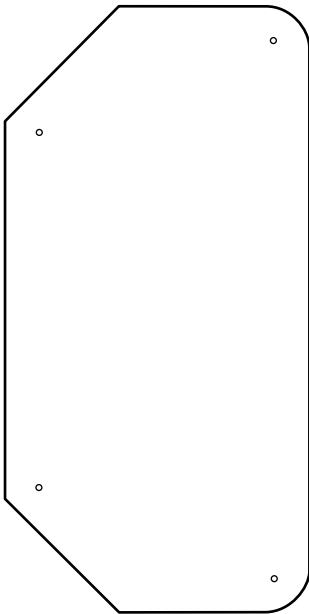

4 Glass shelf x 2
(80 x 40cm)



5 Metal tube x 4
(5.08 x 8cm)



6 Metal feet x 4
(5.2 x 1.2cm)

Ruler - Use this ruler to help correctly identify the screws

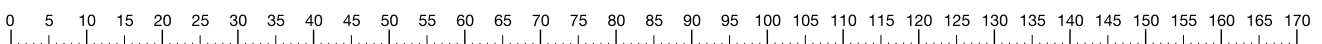

Assembly Instructions

Step 1

Attaching metal rods

Please attach the 4pcs of metal rod **1** onto panel **2** as shown.

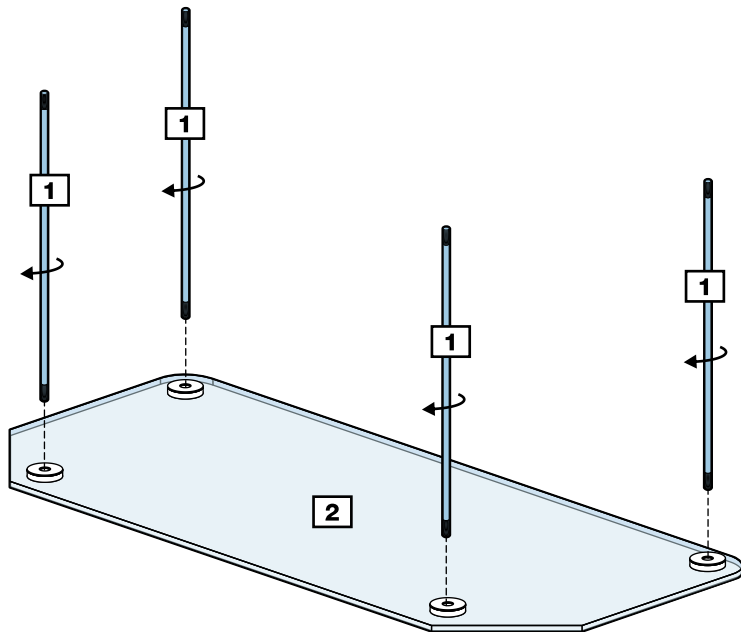

Step 2

Attaching metal tubes

Attach 4 pcs of metal tubes **3** through 4 pcs of metal rods **1** as shown.

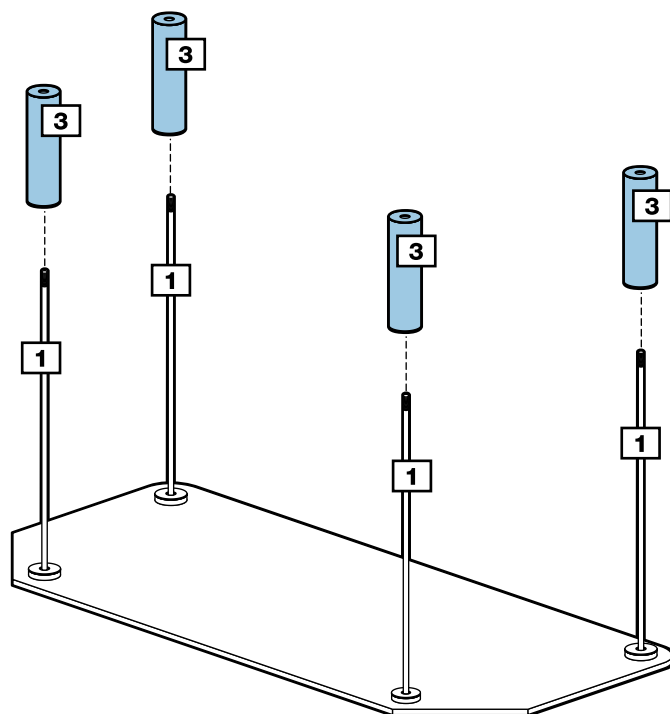

Assembly Instructions

Step 4

Attaching glass shelf

Two people are needed here.

Attach glass shelf **4** through 4 pcs of metal rods **1** as shown.



Warning:
The unit is heavy.
Lift with care.

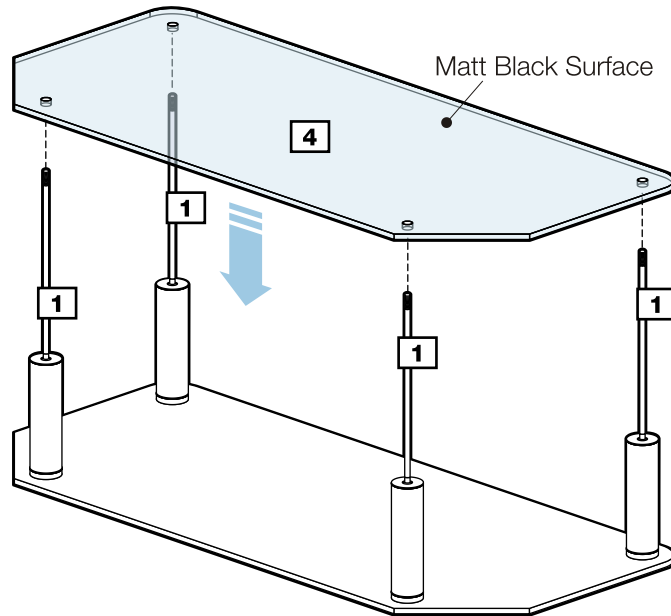

Step 5

Attaching metal tubes

Attach 4 pcs of metal tubes **3** through 4 pcs of metal rods **1** as shown.

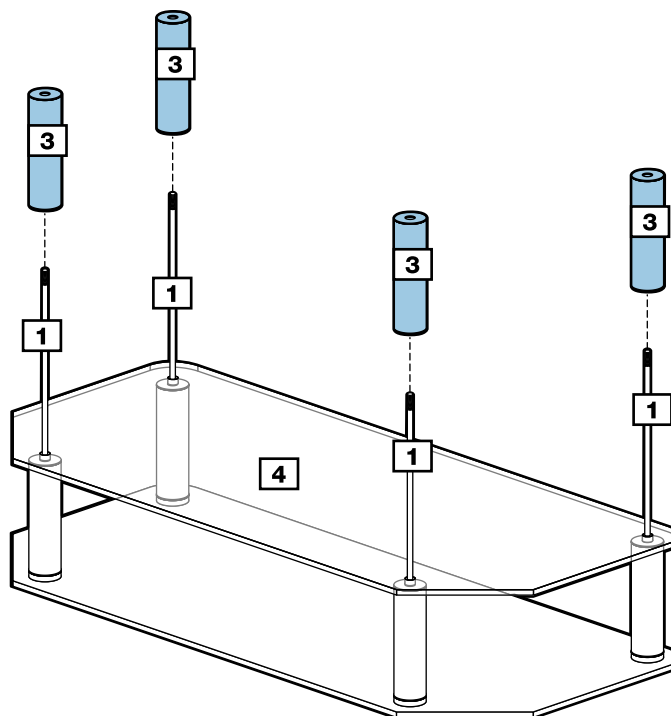

Assembly Instructions

Step 6

Attaching glass shelf

Two people are needed here.

Attach glass shelf **4** through 4 pcs of metal rods **1** as shown.



Warning:
The unit is heavy.
Lift with care.

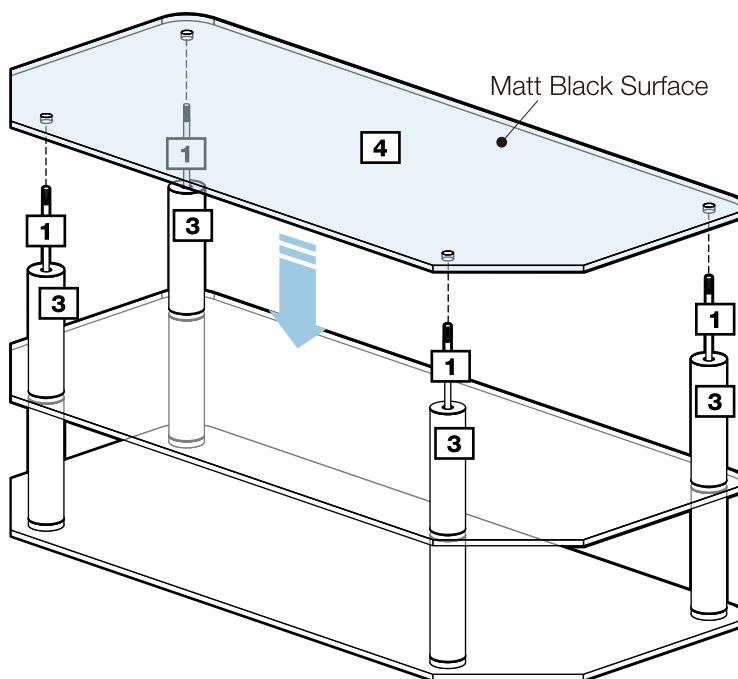

Step 7

Attaching metal tubes

Attach 4 pcs of metal tubes **5** through 4 pcs of metal rods **1** as shown.

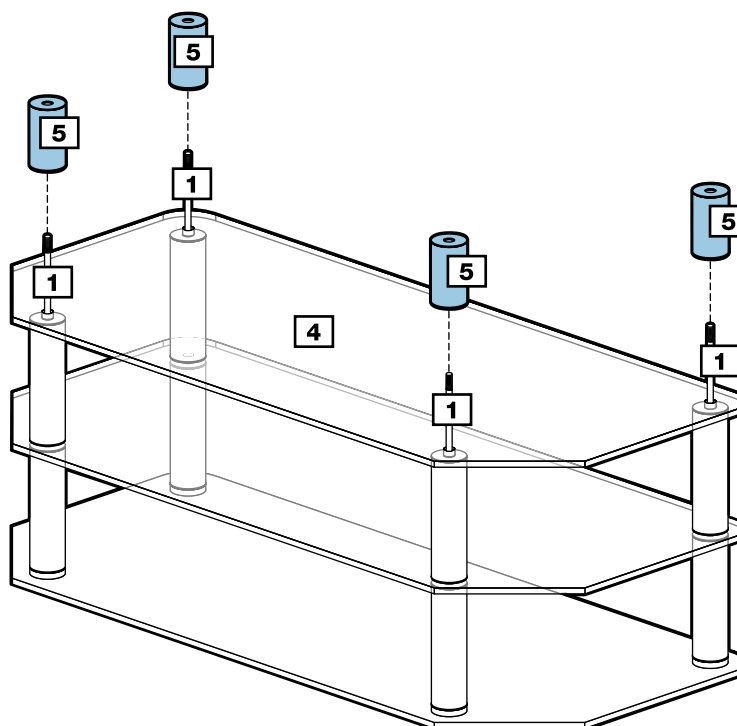

Assembly Instructions

Step 8

Attaching foot

Finger tighten 4 pcs of feet **6** onto the unit as shown.

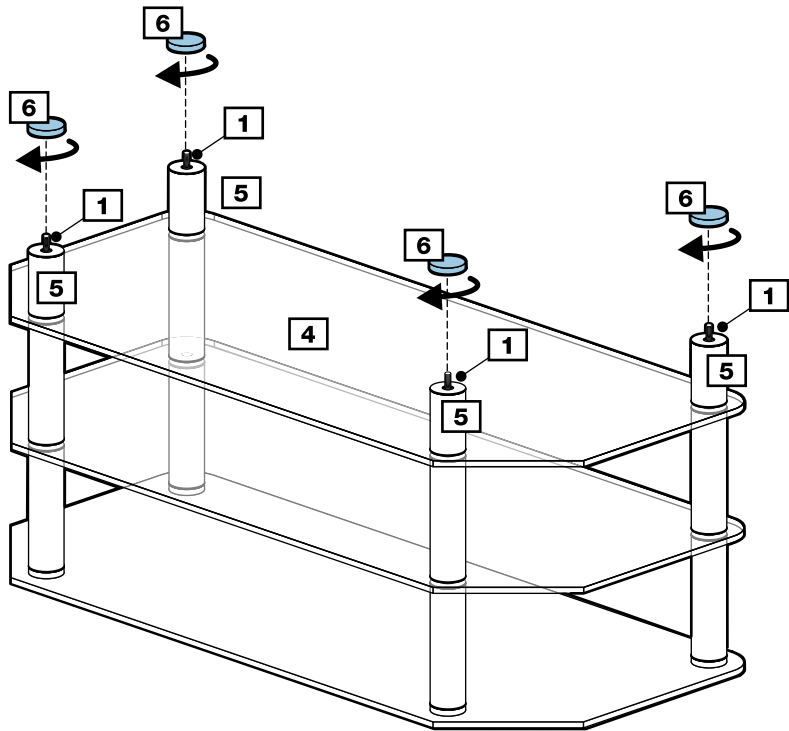

Step 9



Warning:
The unit is heavy.
Turn with care.

Assembly is complete.

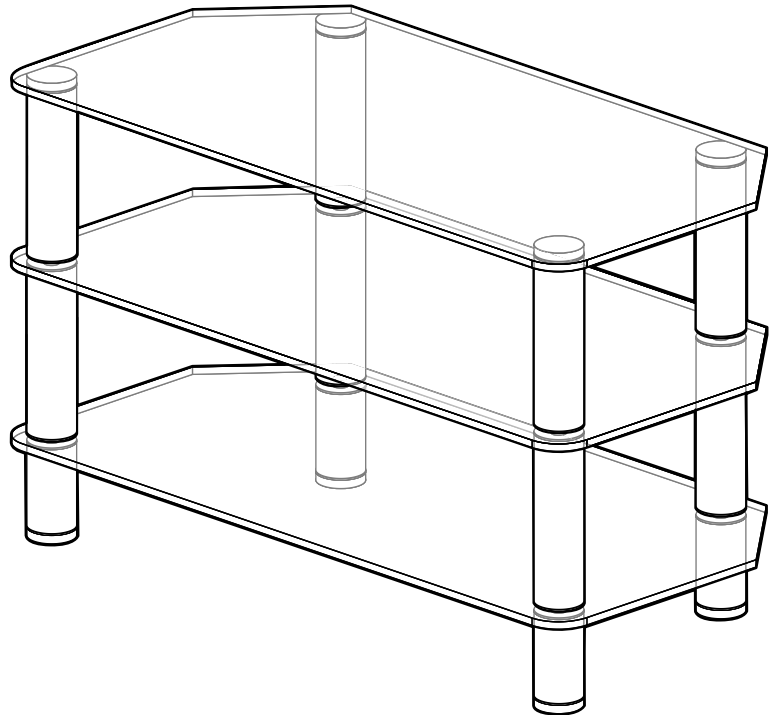

If you need help or have damaged or missing parts, call the Customer Helpline: 08456 400800