

DAILY REFERENCE GUIDE



THANK YOU FOR PURCHASING AN HOTPOINT PRODUCT

To receive more comprehensive help and support, please register your product at www.hotpoint.eu/register



You can download the Safety Instructions and the Use and Care Guide by visiting our website docs.hotpoint.eu and following the instructions on the back of this booklet.



Before using the appliance carefully read the Health and Safety guide.

PRODUCT DESCRIPTION

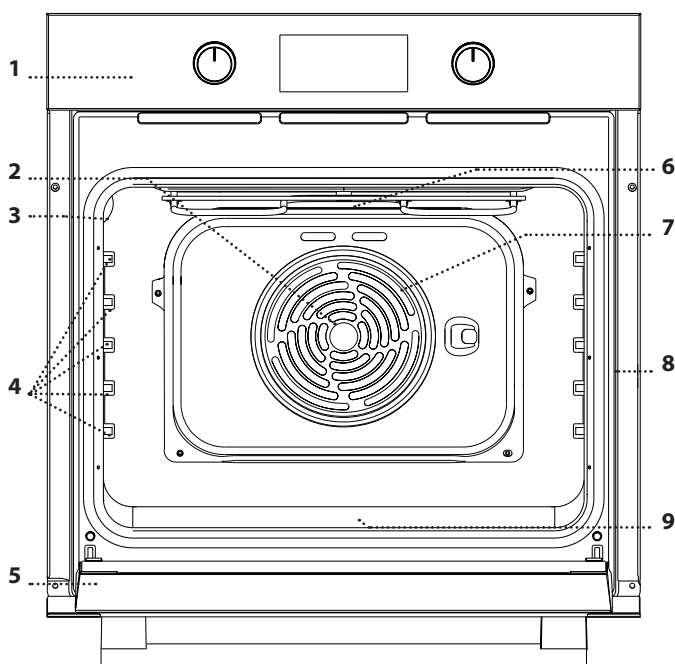

1. Control panel
2. Fan
3. Lamp
4. Shelf guides
(the level is indicated on the wall of the cooking compartment)
5. Door
6. Upper heating element / grill
7. Circular heating element
(not visible)
8. Identification plate
(do not remove)
9. Bottom heating element
(not visible)

CONTROL PANEL

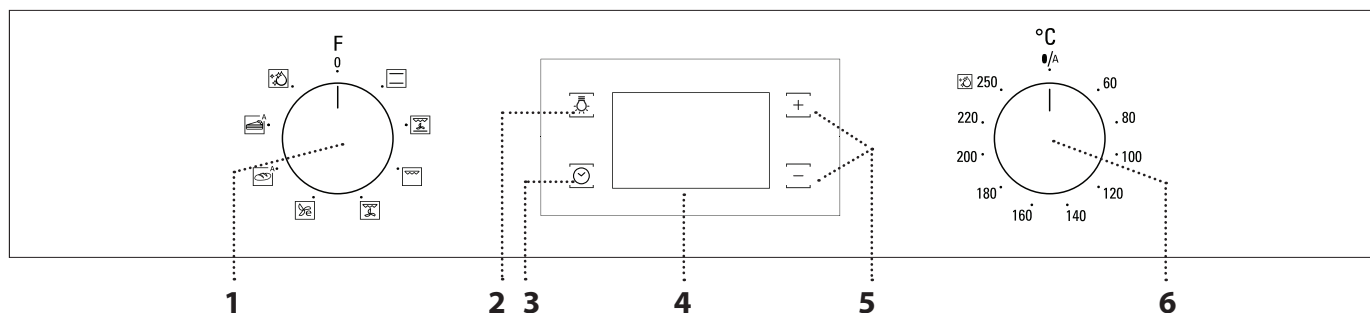

1. SELECTION KNOB

For switching the oven on by selecting a function. Turn to the 0 position to switch the oven off.

2. LIGHT

With the oven switched on, press to turn the oven compartment lamp on or off.

3. SETTING THE TIME

For accessing the cooking time settings, delayed start and timer. For displaying the time when the oven is off.

4. DISPLAY

5. ADJUSTMENT BUTTONS
For changing the cooking time settings.

6. THERMOSTAT KNOB

Turn to select the temperature you require when activating manual functions. Automatic functions use \bullet/A .

WIRE SHELF

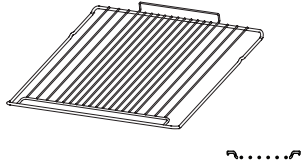

BAKING TRAY

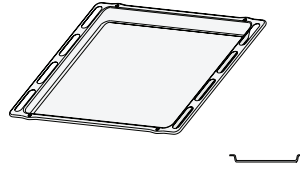



The number of accessories may vary depending on which model is purchased. Other accessories can be purchased separately from the After-sales Service.

INSERTING THE WIRE SHELF AND OTHER ACCESSORIES

- Insert the wire shelf onto the level you require by holding it tilted slightly upwards and resting the raised rear side (pointing upwards) down first. Next, slide it horizontally along the shelf guide as far as possible.
- The other accessories, such as the drip tray and the baking tray, are inserted horizontally by sliding them along the shelf guides.

FUNCTIONS



 **CONVECTION**
For cooking any kind of dish on one shelf only.

 **CONVECTION BAKE**
For cooking on a maximum of two shelves at the same time. It is a good idea to swap the position of the baking plates halfway through cooking.

 **GRILL**
For grilling steaks, kebabs and sausages, cooking vegetables au gratin or toasting bread. When grilling meat, we recommend using a baking tray to collect the cooking juices: Position the tray on any of the levels below the wire shelf and add 200 ml of drinking water.

 **TURBO GRILL**
For roasting large joints of meat (legs, roast beef, chicken). We recommend using a baking tray to collect the cooking juices: Position the tray on any of the levels below the wire shelf and add 200 ml of drinking water.

 **DEFROSTING**
For defrosting food more quickly.

 **ECO CONVECTION BAKE***
For cooking roasts and stuffed roasting joints on a single shelf. Food is prevented from drying out excessively by gentle, intermittent air circulation. When this ECO MODE function is in use, the light will remain switched off during cooking but can be switched on again by pressing .



 **BREAD AUTO**
This function automatically selects the ideal temperature and baking time for bread. For best results, carefully follow the recipe. Activate the function when the oven is cold.

 **PASTRY AUTO**
This function automatically selects the ideal temperature and baking time for cakes. Activate the function when the oven is cold.







* Function used as reference for the energy efficiency declaration in accordance with Regulation (EU) No. 65/2014

USING THE APPLIANCE FOR THE FIRST TIME

1. SETTING THE TIME

You will need to set the time when you switch on the appliance for the first time: press  until the  icon and the two digits for the hour start flashing on the display.



Use  or  to set the hour and press  to confirm. The two digits for the minutes will start flashing. Use  or  to set the minutes and press  to confirm.

Please note: When the  icon is flashing, for example following lengthy power outages, you will need to reset the time.

2. REHEAT THE OVEN

A new oven may release odours that have been left behind during manufacturing: this is completely normal.

Before starting to cook food, we therefore recommend heating the oven with it empty in order to remove any possible odours.

Remove any protective cardboard or transparent film from the oven and remove any accessories from inside it.

Heat the oven to 250° C for about one hour, preferably using the "Convection bake" function. The oven must be empty during this time. Follow the instructions for setting the function correctly.

Please note: It is advisable to air the room after using the appliance for the first time.

DAILY USE

1. SELECT A FUNCTION

To select a function, turn the *selection knob* to the symbol for the function you require: the display will light up and an audible signal will sound.



2. ACTIVATE A FUNCTION

MANUAL

To start the function you have selected, turn the *thermostat knob* to set the temperature you require.

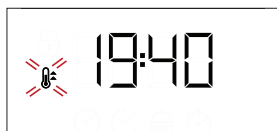

Please note: During cooking you can change the function by turning the *selection knob* or adjust the temperature by turning the *thermostat knob*.

The function will not start if the thermostat knob is on 0 °C. You can set the cooking time, cooking end time (only if you set a cooking time) and a timer.

AUTOMATIC

To start the automatic function you have selected ("Bread" or "Dessert"), keep the *thermostat knob* at the position for automatic functions (●/A).

To finish cooking, turn the *selection knob* to position 0.

Please note: You can set the cooking end time and timer.

3. PREHEATING

Once the function starts, an audible signal and a flashing icon  on the display indicate that the preheating phase has been activated.



At the end of this phase, an audible signal and the fixed icon  on the display will indicate that the oven has reached the set temperature: at this point, place the food inside and proceed with cooking.

Please note: Placing the food in the oven before preheating has finished may have an adverse effect on the final cooking result.



. PROGRAMMING COOKING

You will need to select a function before you can start programming cooking.

DURATION

Keep pressing  until the  icon and "00:00" start flashing on the display.



Use  or  to set the cooking time you require, then press  to confirm.



Activate the function by turning the *thermostat knob* to the temperature you require: an audible signal will sound and the display will indicate that cooking is complete.

Notes: To cancel the cooking time you have set, keep pressing  until the  icon starts flashing on the display, then use  to reset the cooking time to "00:00". This cooking time includes a preheating phase.

PROGRAMMING THE END COOKING TIME/DELAYED START

After a cooking time has been set, starting the function can be delayed by programming its end time: press  until the  icon and the current time start flashing on the display.



Use  or  to set the time you want cooking to end and press  to confirm.

Activate the function by turning the *thermostat knob* to the temperature you require: the function will remain paused until it starts automatically after the period of time that has been calculated in order for cooking to finish at the time you have set.



Please note: To cancel the setting, switch the oven off by turning the *selection knob* to position "0".

END OF COOKING

An audible signal will sound and the display will indicate that the function has finished.





Turn the *selection knob* to select a different function or to position "0" to switch the oven off.



Please note: If the timer is active, the display will show "END" alternately with the remaining time.

. SETTING THE TIMER

This option does not interrupt or program cooking but allows you to use the display as a timer, either during while a function is active or when the oven is off.

Keep pressing  until the  icon and "00:00" start flashing on the display.































































Use  or  to set the time you require and press  to confirm.

































An audible signal will sound once the timer has finished counting down the selected time.

Notes: To cancel the timer, keep pressing  until the  icon starts flashing, then use  to reset the time to "00:00".

COOKING TABLE

RECIPE	FUNCTION	PREHEAT	TEMPERATURE (°C)	DURATION (MIN)	LEVEL AND ACCESSORIES
Leavened cakes		Yes	160 - 180	30 - 90	2/3 
		Yes	160 - 180	30 - 90 ***	4  1 
Filled cake (cheese cake, strudel, fruit pie)		Yes	160-200	35-90	2 
		Yes	160-200	35 - 90 ***	4  2 
Biscuits/tartlets		Yes	170 - 180	15 - 45	3 
		Yes	160 - 180	20 - 45 ***	4  2 
Choux buns		Yes	180 - 220	30-40	3 
		Yes	180-190	35 - 45 ***	4  2 
Meringues		Yes	90	150 - 200	3 
		Yes	90	140 - 200	4  2 
Bread		-	-	60	2 
Bread/pizza/focaccia		Yes	190-250	15-50	2 
		Yes	190-250	25 - 50 ***	4  2 
Frozen pizza		Yes	250	10 - 15	3 
		Yes	250	10 - 20 ***	4 
Salty cakes (vegetable pie, quiche)		Yes	175 - 200	45 - 60	3 
		Yes	175 - 200	45 - 60 ***	4  2 
Vols-au-vents/puff pastry crackers		Yes	190 - 200	20-30	3 
		Yes	180-190	15 - 40 ***	4  2 
Lasagna/baked pasta/cannelloni/flans		Yes	190 - 200	45 - 65	2 
Lamb/veal/beef/pork 1 kg		Yes	190 - 200	80 - 110	3 

FUNCTIONS						
	Conventional	Grill	Turbo Grill	Convection Bake	Bread Auto	Eco Convection Bake
ACCESSORIES						
	Wire shelf	Baking dish or baking tray on the wire shelf	Baking tray / oven tray on wire shelf	Baking tray with 200 ml of water	Baking tray	

RECIPE	FUNCTION	PREHEAT	TEMPERATURE (°C)	DURATION (MIN)	LEVEL AND ACCESSORIES
Chicken / rabbit / duck 1 kg		Yes	200 - 230	50 - 100	2 
Turkey/goose 3 kg		-	190 - 200	100 - 160	2 
Baked Whole Fish (fillet, whole)		Yes	170 - 190	30 - 50	2 
Stuffed vegetables (tomatoes, courgettes, aubergines)		Yes	180-200	50 - 70	2 
Toasted bread		5'	250	2 - 6	5 
Fish fillets/slices		-	230 - 250	15 - 30 *	4 
Sausages/kebabs/spare ribs/hamburgers		-	250	15 - 30 *	5 
Roast chicken 1-1.3 kg		Yes	200 - 220	55 - 70 **	2 
Roast beef rare 1 kg		Yes	200 - 210	35 - 50 **	3 
Leg of lamb/knuckle		Yes	200 - 210	60 - 90 **	3 
Roast potatoes		Yes	200 - 210	35 - 55 **	3 
Vegetable gratin		-	200 - 210	25 - 55	3 
Lasagne and meat		Yes	200	50 - 100 ****	4 
Meat and potatoes		Yes	190 - 200	45 - 100 ****	4 
Fish and vegetables		Yes	180	30 - 50 ****	4 
Roast meat/stuffed roasting joints		-	170 - 180	100 - 150	2 

The time indicated does not include the preheating phase: we recommend placing the food in the oven and setting the cooking time only after the required temperature has been reached.











* Turn food halfway through cooking

** Turn food two-thirds of the way through cooking (if necessary).

*** Switch levels halfway through cooking.

**** Estimated length of time: dishes can be removed from the oven at different times depending on personal preference. Switch shelves two-thirds of the way through cooking, if necessary.

Download the Use and Care Guide from docs.hotpoint.eu for the table of tested recipes, compiled for the certification authorities in accordance with the standards IEC and IEC 60350-1.

FUNCTIONS						
	Conventional	Grill	Turbo Grill	Convection Bake	Bread Auto	Eco Convection Bake
ACCESSORIES						
	Wire shelf	Baking dish or baking tray on the wire shelf	Baking tray / oven tray on wire shelf	Baking tray with 200 ml of water	Baking tray	

MAINTENANCE AND CLEANING



Download the Use and Care Guide from docs.hotpoint.eu for more information

Do not use steam cleaning equipment.

Use protective gloves during all operations.

Carry out the required operations with the oven cold.

Disconnect the appliance from the power supply.

Do not use wire wool, abrasive scourers or abrasive/corrosive cleaning agents, as these could damage the surfaces of the appliance.

EXTERIOR SURFACES

- Clean the surfaces with a damp microfibre cloth. If they are very dirty, add a few drops of pH-neutral detergent. Finish off with a dry cloth.
- Do not use corrosive or abrasive detergents. If any of these products inadvertently comes into contact with the surfaces of the appliance, clean immediately with a damp microfibre cloth.

INTERIOR SURFACES

- After every use, leave the oven to cool and then clean it, preferably while it is still warm, to remove any deposits or stains caused by food residues. To dry any condensation that has formed as a result of cooking foods with a high water content, leave the oven to cool completely and then wipe it with a cloth or sponge.

- Activate the "Diamond Clean" function for optimum cleaning of the internal surfaces..
- The door can be easily removed and refitted to facilitate cleaning of the glass.
- Clean the glass in the door with a suitable liquid detergent.
- The top heating element of the grill can be lowered to clean the upper panel of the oven.

ACCESSORIES

Soak the accessories in a washing-up liquid solution after use, handling them with oven gloves if they are still hot. Food residues can be removed using a washing-up brush or a sponge.

REMOVING AND REFITTING THE DOOR

1. To remove the door, open it fully and lower the catches until they are in the unlock position.

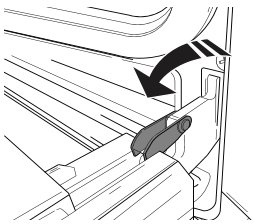

2. Close the door as much as you can. Take a firm hold of the door with both hands – do not hold it by the handle. Simply remove the door by continuing to close it while pulling it upwards (a) at the same time until it is released from its seating (b).

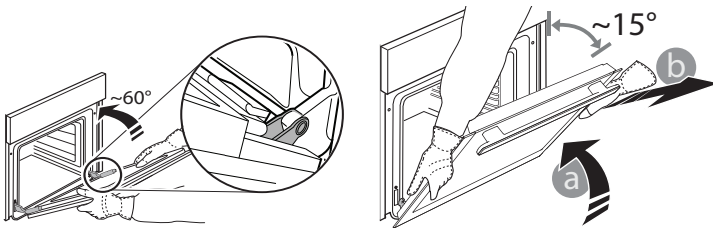

Put the door to one side, resting it on a soft surface.

3. Refit the door by moving it towards the oven, aligning the hooks of the hinges with their seating and securing the upper part onto its seating.

4. Lower the door and then open it fully. Lower the catches into their original position: make sure that you lower them down completely.

5. Try closing the door and check to make sure that it lines up with the control panel. If it does not, repeat the steps above.

CLICK TO CLEAN - CLEANING THE GLASS

1. After removing the door and resting it on a soft surface with the handle downwards, simultaneously press the two retaining clips and remove the upper edge of the door by pulling it towards you.

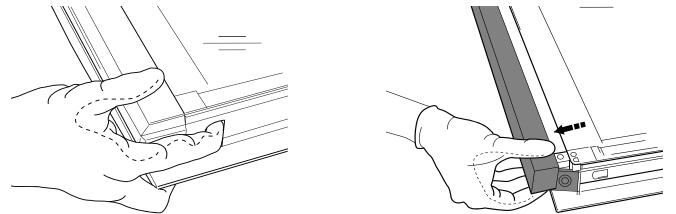

2. Lift and firmly hold the inner glass with both hands, remove it and place it on a soft surface before cleaning it.

3. To correctly reposition the inner glass, make sure that the "R" is visible in the right-hand corner and the clear surface (not printed) is facing up. First insert the long side of the glass indicated by "R" into the support seats, then lower it into position.

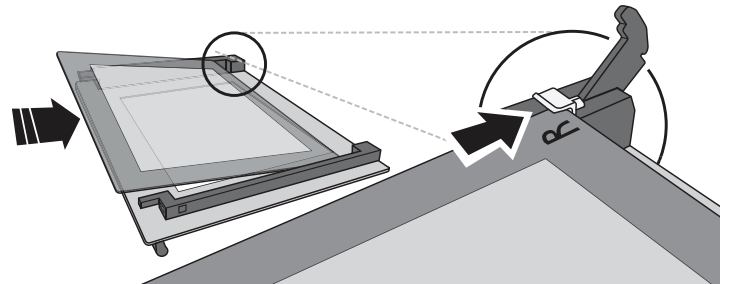

4. Refit the upper edge: a click will indicate correct positioning. Make sure the seal is secure before refitting the door.

Problem	Possible cause	Solution
The oven does not work	Power cut. Disconnection from the mains.	Check for the presence of mains electrical power and whether the oven is connected to the electricity supply. Turn off the oven and restart it to see if the fault persists
The display shows the letter "F" followed by a number	Software problem	Contact you nearest After-sales Service Centre and state the letter or number that follows the letter "F"

USEFUL TIPS



Download the Use and Care Guide from docs.hotpoint.eu for more information

HOW TO READ THE COOKING TABLE

The table lists the best function, accessories and level to use to cook different types of food. Cooking times start from the moment food is placed in the oven, excluding preheating (where required). Cooking temperatures and times are approximate and depend on the amount of food and the type of accessory used. Use the lowest recommended settings to begin with and, if the food is not cooked enough, then switch to higher settings. Use the accessories supplied and preferably dark-coloured metal cake tins and baking trays. You can also use Pyrex or stoneware pans and accessories, but bear in mind that cooking times will be slightly longer.

BREAD AUTO FUNCTION

For best results you should carefully follow the instructions, using the recipe for mixing 1000 g of dough: 600 g of flour, 360 g of water, 11 g of salt, 25 g of fresh yeast (or two packets of yeast powder).

For optimal rising, allow about 90 minutes at room temperature.

Put the dough into the (cold) oven, pour 100 cc of cold drinking water on to the bottom of the oven and activate the "Bread Auto" function. After cooking, leave the dough to stand on a wire shelf until completely cooled.

COOKING DIFFERENT FOODS AT THE SAME TIME

Using the "Convection Bake" function, you can cook different foods simultaneously (for example: fish and vegetables), using different shelves. Remove the food which requires a shorter cooking time and leave the food which requires a longer cooking time in the oven.

PRODUCT FICHE

The product fiche with energy data of this appliance can be downloaded from the website docs.hotpoint.eu

HOW TO OBTAIN THE USE AND CARE GUIDE

> Download the Use and Care Guide from our website docs.hotpoint.eu (you can use this QR Code), specifying the product's commercial code.



> Alternatively, contact our Client After-sales Service

CONTACTING OUR AFTER-SALES SERVICE

You can find our contact details in the warranty manual. When contacting our Client After-sales Service, please state the codes provided on your product's identification plate.

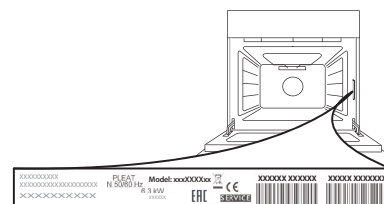

400010871345

Printed in Italy