

GASLIFT BAR TABLE

ASSEMBLY INSTRUCTIONS

Before you start, here is some helpful advice:

1. We suggest you spend a short time reading through this leaflet and follow the simple step-by-step assembly instructions.
2. Do not discard any of the packaging until you have checked that you have all the parts and the pack of fittings.
3. Assemble this product on a flat surface.
4. Assemble all parts loosely before tightening any bolts.
5. Discard all extra fittings and keep fittings out of reach of children.
6. To clean, wipe clean with a damp cloth.
7. Retain Assembly Instruction for future reference.

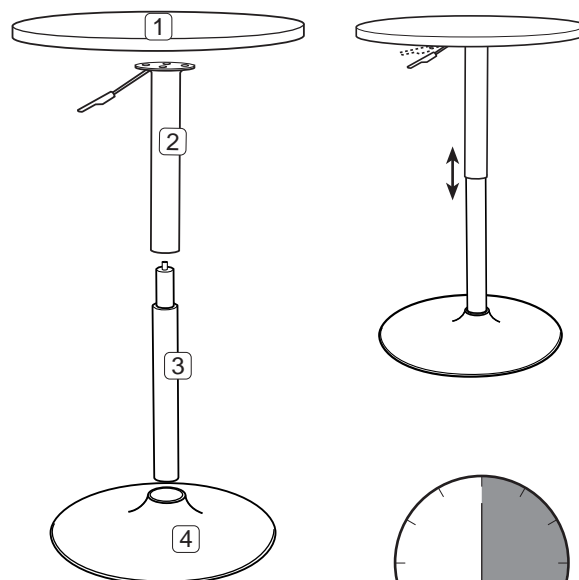

ADDITIONAL TOOLS REQUIRED

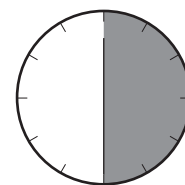
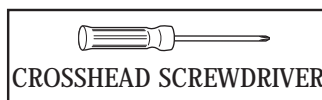



APPROXIMATE
TIME OF ASSEMBLY:
30 MINUTES

PARTS LIST

CODE	DESCRIPTION	QTY.
1	TABLE TOP	1
2	LEG	1
3	GASLIFT	1
4	BASE	1

FITTINGS LIST

CODE	DESCRIPTION	QTY.
a	 BOLT	4
b	 WASHER	4
c	 SPRING WASHER	4

1

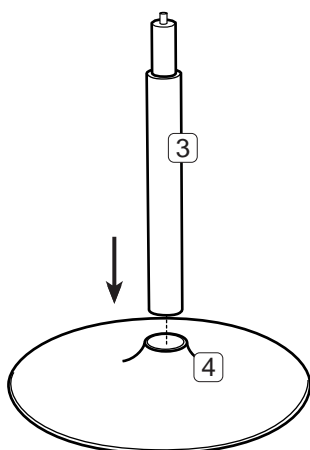

2

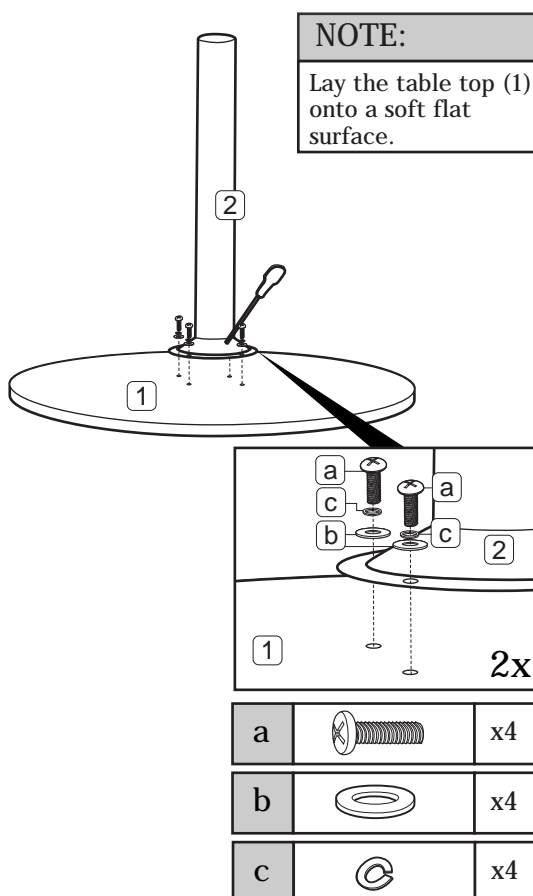

3

GASLIFT OPERATION:

To adjust the table higher, lift up the lever under the table and release at desired height. To lower the table, lift up the lever while press down the table top with some force.

