

CHALLENGE

1100W Electric Hover Mower

5991963
(Model: MEH1129B)

Original Manual



challenge[®]



After Sales Support
UK/Ireland

0343 515 1906

Important - Please read these instructions fully before starting assembly

These instructions contain important information that will help you get the best from your mower, ensuring it is assembled correctly and safely.

If you need help or have damaged or missing parts, call the Customer Helpline on 0343 515 1906 .

Contents

Safety Information.....	3
Warning Symbols.....	3
General Safety.....	5
Personal Safety.....	6
Operating and Maintenance Safety.....	10
In the Box.....	12
Parts.....	12
Assembly.....	10
Handle Assembly.....	10
Operating Instructions & Tips.....	12
Setting the Cutting Heights.....	12
ON/OFF Operation.....	17
Operation.....	18
Emptying the grassbox.....	18
Mowing Advice.....	19
Maintenance.....	20
Cleaning & Maintenance.....	20
Blade Maintenance.....	21
Maintenance and Storage.....	21
Troubleshooting.....	22
General Troubleshooting.....	22
Technical Data.....	23
Technical Data Table.....	23
Disposal.....	23
Disposal and Recycling.....	23
Getting Help.....	23

Safety Information

Important - Please read these instructions fully before starting assembly

Warnings Symbols

 The following warning symbols appear throughout this manual and indicate the appropriate safety measures you should take when assembling and operating the mower.

Take extra care, beware of hazards.

 Read instruction manual.

 Wear eye and ear protection.

 Do not use the machine in the rain or leave it outdoors when it is raining.

 Pay attention that bystanders are not injured by objects thrown out from the machine.

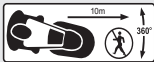
 Keep bystanders away. Do not operate whilst people especially children or pets are in the area.

 Switch off! Remove plug from mains before adjusting, cleaning or if cable is entangled or damaged. Keep the cable away from the cutting parts.

 Disconnect from the mains supply before any maintenance work.

 Warning. Beware of electric shocks

Safety Information

Important - Please read these instructions fully before starting assembly

Warnings Symbols (continued)



Keep the mains supply cord away from the cutting blade.



Noise level specification Lwa in dB.



Protection class II



Do not dispose of electrical equipment in domestic waste.



Cutting width



Important! When using equipment, the following safety precautions must be followed to avoid injuries and damage.

- Read all operating instructions carefully and comply with them. It is important to understand these instructions and to acquaint yourself with the machine, its correct usage and all safety requirements.
- Keep this manual in a safe place so that the information is available at all times.
- If you give the equipment to any other person, give them these operating instructions as well.



Safety Information

Important - Please read these instructions fully before starting assembly

General Safety

We accept no liability for damage or accidents which result from non-compliance with these instructions.

Intended usage

This hover mower is designed for use in private gardens. The machine is to be used for its prescribed purpose only. Any other use is deemed to be a case of misuse. The user / operator and not the manufacturer will be liable for any damage or injuries of any kind caused as a result of misuse.

Please note that this equipment has not been designed for use in commercial, trade or industrial applications. Your warranty will also be voided if the machine is used in commercial, trade or industrial businesses or for equivalent purposes.

Assembly

The push handles must be fully assembled, undamaged and in correct working order before using the hover mower.

Follow the operating instructions step-by-step and use the pictures provided as a visual guide to assemble these parts.

Power supply

Before you connect the equipment to the mains supply ensure that the data on the rating plate corresponds to your mains supply.



Safety Information

Important - Please read these instructions fully before starting assembly

Personal Safety



Note! Only supply power to the equipment through a circuit protected by an RCD with a maximum trip current of 30 mA.

- Use only plugs or connectors approved for outdoor usage.
- Extension cables must comply to H07RN-F requirements as described in DIN 57 282/VDE 0282 and must have a minimum cross-section of 1.5 mm². The plug must have an earth and any connection must also be earthed and splashproof. Before use, check the cables for signs of damage and ageing. Never use the mower if the cables are not in perfect condition (this also applies to the supply cable on the mower). If the cable is damaged whilst the mower is working, disconnect the mains plug from the power supply immediately and then check the extent of the damage.
- Never allow children or others who are not familiar with the operating instructions to use the hover mower. Local regulations may stipulate the minimum age of the user of this type of machinery.
- In areas where the mains supply is weak or bearing a high load, this mower may cause further voltage fluctuations as it starts. In extreme cases, this can cause damage to other equipment working from the same supply. In this case we recommend to temporarily switch off any unneeded equipment or connect it to a different circuit.
- This machine is not designed to be used by people (including children) with limited physical, sensory or mental capacities or those with no experience and/or knowledge unless they are supervised by a person who is responsible for their safety or they have received instructions from such a person in how to use the



Safety Information

Important - Please read these instructions fully before starting assembly

Personal Safety (continued)

machine safely. Children must always be supervised in order to ensure that they do not play with the machine.

- Always check the mower for signs of damage before each usage.
- Always disconnect the mains lead from the electrical supply before carrying out any inspection, servicing or maintenance work.
- Ensure that all the guards are securely fitted and in good working order.
- Before each use, inspect the mower to check the plastic cutters, fastening bolts and the entire cutting unit for any signs of wear or damage. To prevent imbalance or vibration, worn or damaged cutting blades and fastening bolts must always be replaced in full.
- Damaged parts on the mower must be replaced by qualified personnel. Use only genuine spare parts.
- Repair work on the electrical parts of the mower may only be carried out by a qualified electrician.
- Follow the instructions to fit or remove the plastic cutters and wear protective gloves.
- The user remains responsible for any injury to third parties within the working area of the hover mower whilst the hover mower is being used.
- Only work in good daylight or appropriate and adequate artificial light.
- Never use the mower when you are tired.
- Never run the mower in enclosed or poorly ventilated rooms or if there are inflammable or explosive fluids, vapours or gases nearby.



Safety Information

Important - Please read these instructions fully before starting assembly

Personal Safety (continued)

- Switch off the motor and disconnect the mains lead before cleaning the cutting head and the fan and before you inspect it if the mower has struck a foreign body.
- Check the site on which you intend to use the hover mower and remove all objects that may be caught or thrown up by the mower. Foreign bodies must be removed before you start mowing. Keep an eye of the power cable and keep it away from the cutting blade at all times.
- Ensure that you do not push the mower over areas that might damage or snare the power cable.
- Before you lift the hover mower to transport it, switch off the motor, disconnect the mains lead and wait until the cutting head has come to a complete standstill. Ensure the cutting head is facing away from you.
- Never reach towards rotating parts with your hands or feet.
- The safety distance from the moving blade produced by the push handle must be maintained at all times.
- If you use the mower on a small incline, mow across the slope (not in an up and down direction). Always be sure of your footing on slopes.
- Be particularly careful when changing direction with the mower whilst working on a slope.
- Do not use the lawn mower on gradients of over 15 degrees.
- Ensure that you have safe footing at all times whilst working with the mower.
- Always wear strong, anti-slip footwear and long trousers when using the mower. Never mow in bare feet or in open-toed sandals.



Safety Information

Important - Please read these instructions fully before starting assembly

Personal Safety (continued)

- When the mower is running ensure that no person or pet, particularly children and animals, is in the immediate vicinity of the hover mower. Ensure that you keep everybody at least 10meters away from the mower when it is working.
- Switch off the motor and disconnect the plug from the power supply if the mower strikes a foreign body. Check the mower for signs of damage and carry out all necessary repair work before you start the mower again.
- If the hover mower begins to vibrate abnormally, switch it off immediately, disconnect the plug immediately and check it carefully. Ensure that all the nuts, bolts and screws are tight and that the mower is in a safe condition for use.
- Do not leave the mower out in the rain. The lawn must not be wet or very damp.
- Only push the mower at a normal walking pace.
- Be particularly careful when you change the direction of the mower or pull it towards you. Avoid pulling it towards you while the blade is moving.
- Never run or attempt to push the mower over any areas except your lawn or other grassed areas. Carefully actuate the starter switch in accordance with the instructions. (See Operating Instructions)
- Do not switch the mower on and off frequently over a short period of time, and in particular do not play with the ON/OFF switch.
- Do not touch the cutting head until the machine has been disconnected from the mains and the cutting blade has reached a complete standstill.
- Never lift or carry the mower whilst the motor is running.



Safety Information

Important - Please read these instructions fully before starting assembly

Personal Safety (continued)

- Switch off the motor and disconnect the plug whenever you leave the hover mower.
- Keep the hover mower in a dry place which is inaccessible to children at all times.
- Before you adjust or clean the mower or check whether the mains lead is kinked or damaged, switch off the mower and disconnect the plug from the power supply.

Operating and Maintenance Safety



CAUTION! Read all safety requirements and instructions.

Any errors made in following the safety requirements and instruction may result in an electric shock, fire and serious injury.

Keep all safety regulations and instructions in a safe place for future use.

- Do not use the lawnmower if the cords are damaged or worn.
- Do not connect a damaged cord to the mains supply or touch a damaged cord before it is disconnected from the mains supply. A damaged cord could allow parts to become live and cause a risk of electrocution.
- Do not attempt to touch the blades before the machine is disconnected from the supply and the blades have come to a complete stop.
- Keep extension cords away from the blade. The blade can cause damage to cords and lead to contact with live parts.



Safety Information

Important - Please read these instructions fully before starting assembly

Operating and Maintenance Safety (continued)



- Disconnect from the mains supply (i.e. remove the plug from the mains socket)

whenever leaving the machine unattended,
before cleaning a blockage,
after striking a foreign object,
whenever the machine starts vibrating abnormally.

In the Box

Parts

- | | | | |
|-----------------------------|------------------------------|----------------------------|-----------------|
| 1 Switch box | 4 Handle fastening wing nuts | 7 Safety lock-off button | 9 Cable clamp |
| 2 Start / Stop switch lever | 5 Lower handle | 8 Cable strain relief hook | 10 Grassbox lid |
| 3 Upper handle | 6 Grassbox | | |



Assembly

Handle Assembly

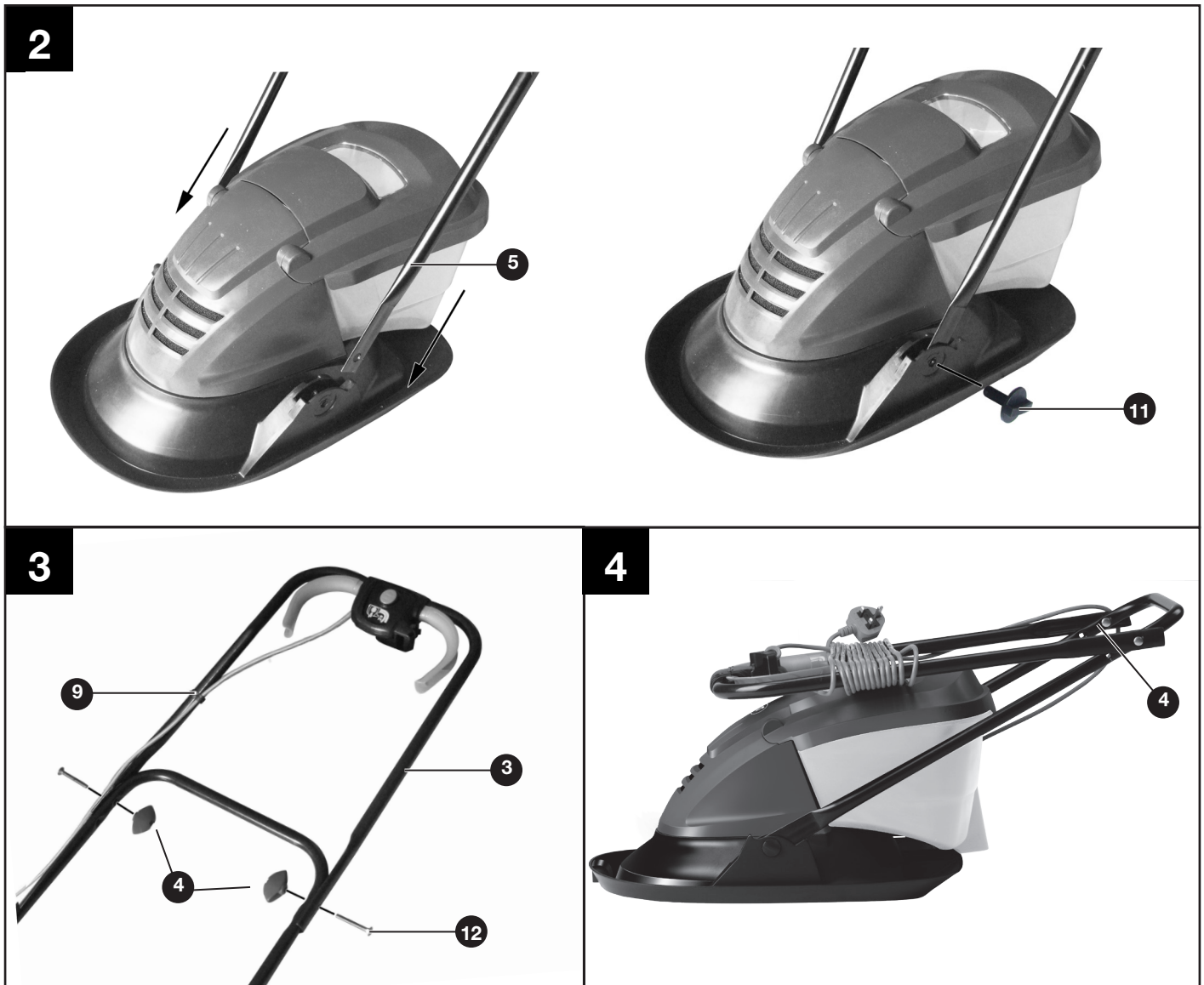

- Place the ends of the lower handle **5** into the slots.
- Secure lower handle **5** to the deck by firmly pushing a retaining pin **11** through the retaining holes on the deck and through the bottom end of the handle.
- Repeat on the other side.
- Ensure the upper handle **3** and the lower handle **5** are aligned correctly and move freely.
- Fix the upper handle **3** section to the lower handle **5**. Use the bolts **12** and wing nuts **4** provided. There are two possible height positions. Choose the one most suitable to the operator's height.
- Clip the cable to the handle bar with the cable clamp **9** provided.

When the two wing nuts are loosened, the handle can be folded (Fig.4) for easy storage. Ensure the power cable is not caught between the folding sections.

Assembly

Handle Assembly (Continued)

5

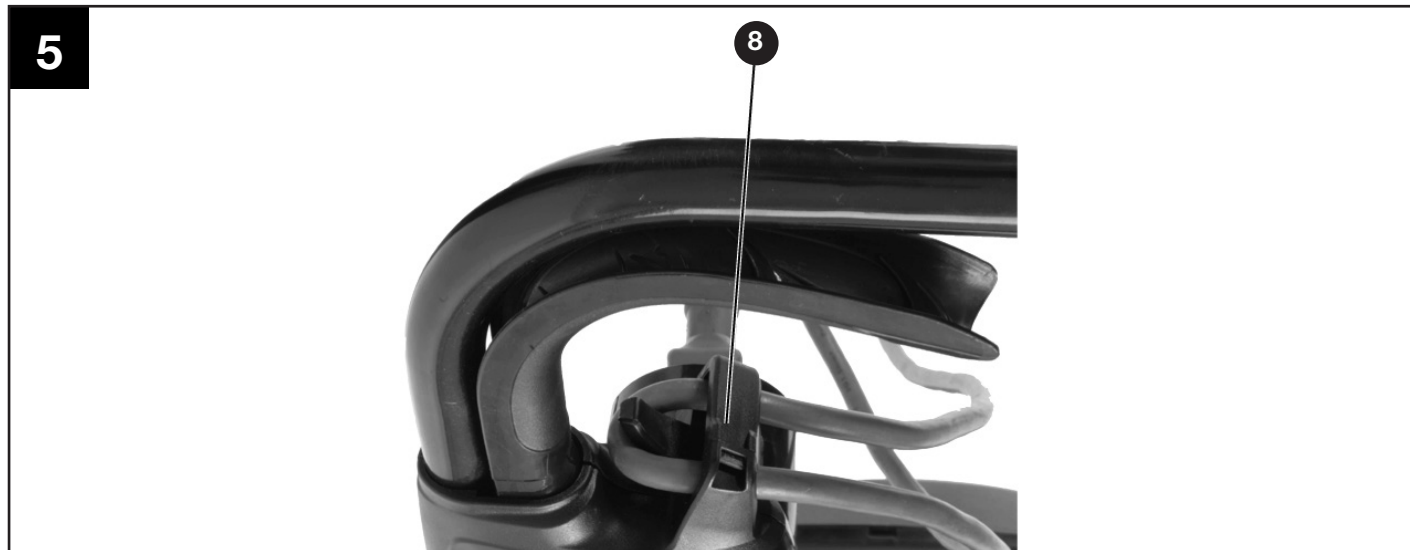

Hook the cable or extension cable (if you are using one) through the extension cable strain relief hook **8** to help prevent it from coming loose or disconnected whilst you are mowing. (Fig. 5)

Operating Instructions & Tips

Setting the Cutting Heights

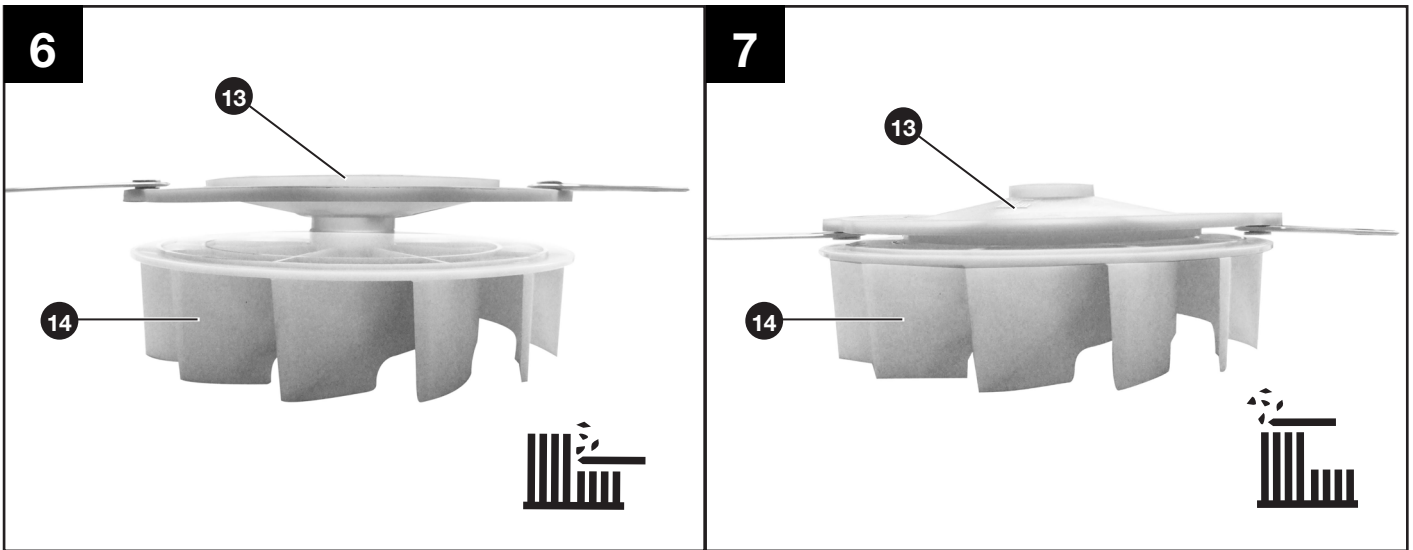

IMPORTANT! Ensure the power cord is disconnected from the mains supply and wait until the cutting head has stopped rotating before adjusting the cutting height.

- There are 2 cutting heights. Fig 6 shows the lower cutting height setting, 10mm. Fig 7 shows the Higher cutting height setting, 33mm. The blade is pre-set to the 33mm cutting height in the factory.
- Height of cut is adjusted by turning over the cutting head **13** .
- Disconnect from the main electricity supply and wait until the fan **14** and the cutting head **13** have stopped rotating.
- Turn your product upside down.



A higher cut height (Fig 7) should generally be selected for the first cut of the season. When cutting longer grass, cut the grass in 2 or more passes, first on the higher cutting setting then on the lower cutting setting. These techniques will help to avoid over-stressing your grass.

Operating Instructions & Tips

Setting the Cutting Heights (Continued)

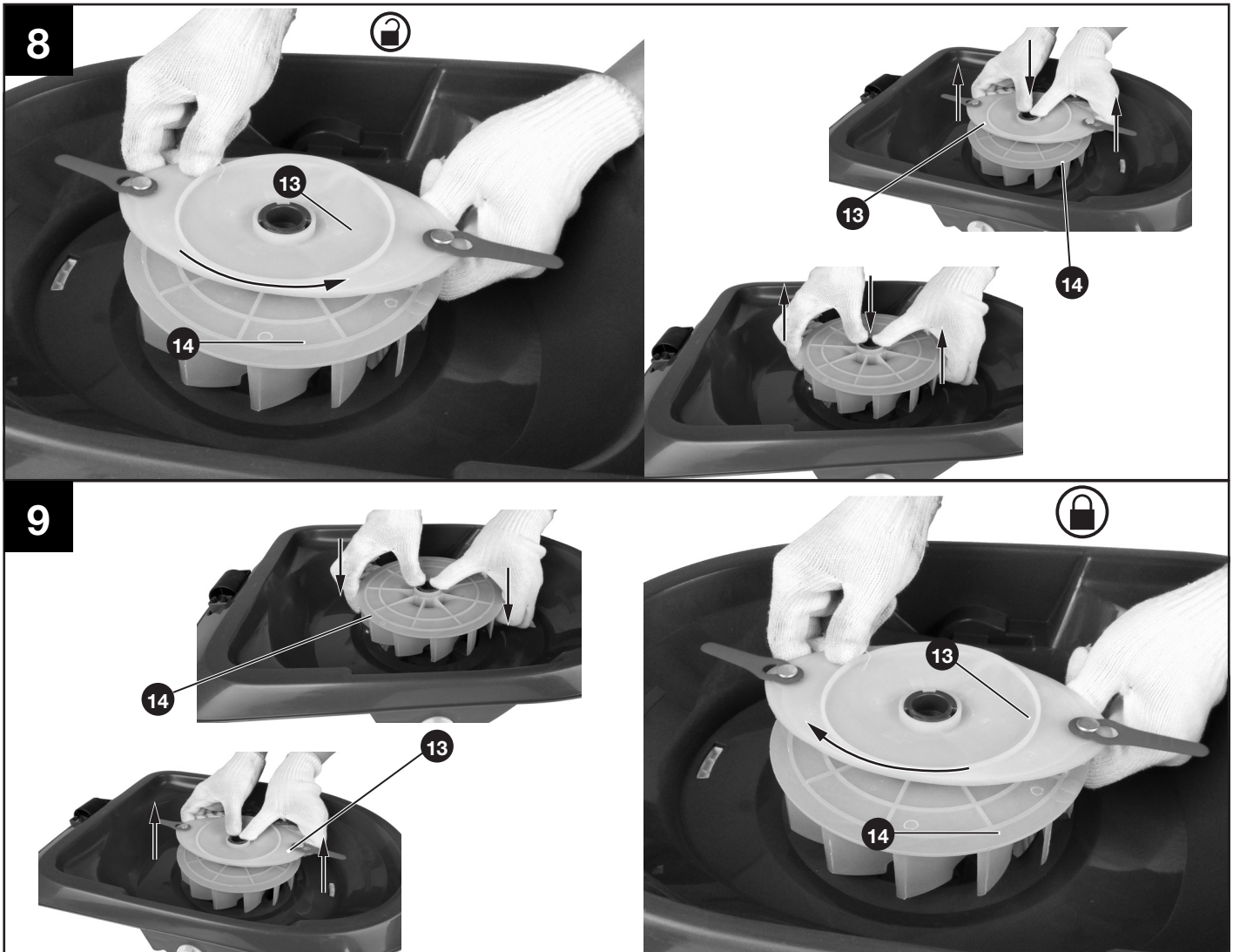

To remove the cutting head and fan (Fig. 8)

- hold the fan **14** firmly and twist the cutting head **13** anticlockwise as illustrated. Hold the cutting head **13** in the centre and remove as illustrated. Hold fan **14** in the centre and remove as illustrated.
- Inspect for damage and clean as necessary before replacing the fan and the cutting head.

To refit the fan and set the cutting height (Fig.9)

- Replace the fan **14** as illustrated on to the motor drive shaft. Position the cutting head **13** onto motor drive shaft according to the height of cut you need. Position the blades flush with the fan if you want the higher setting (33mm). Turn the cutter head **13** the other way around, with a larger space between the fan **14** and the cutting blades, if you want the lower cutting height setting (10mm). Hold the fan **14** firmly and twist the cutting head **13** clockwise as illustrated. Ensure it is securely locked into position.



IMPORTANT! Always ensure the fan and cutting head are correctly located on the drive shaft and securely locked into position. If the blade has broken, it will be difficult to take it off by hand, or even may hurt your fingers, so it is necessary to wear gloves or other protective equipment to prevent harming your fingers.

Operating Instructions & Tips

ON/OFF Operation

10

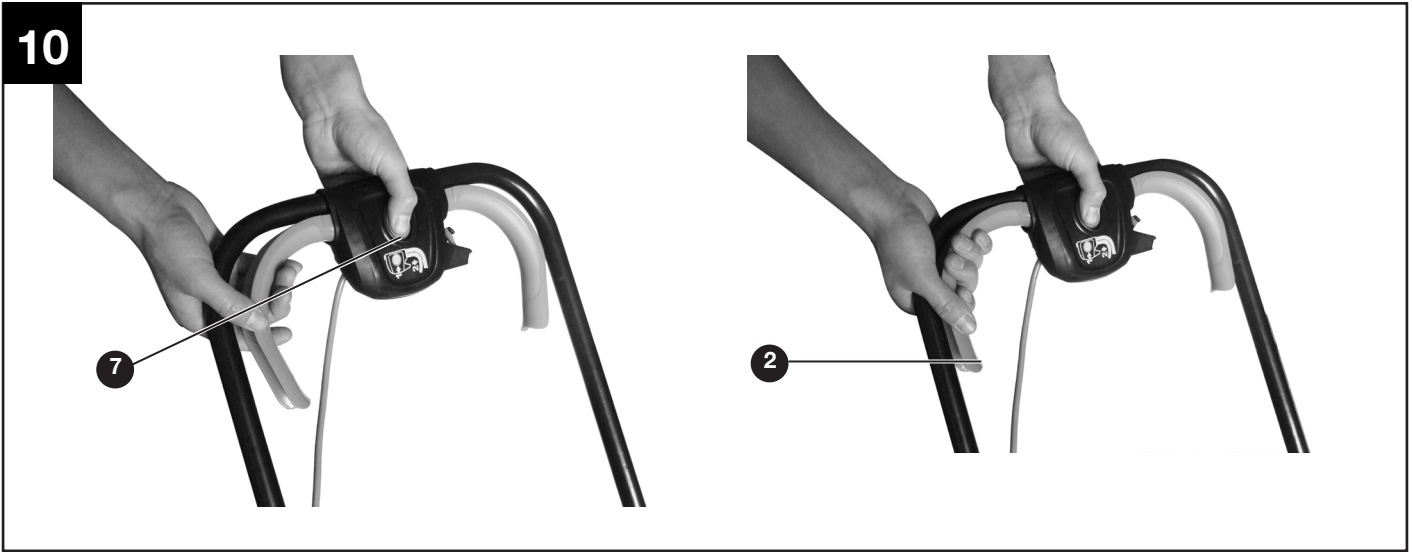

- Connect the mower to your power supply socket. Ensure the cable or extension cable (if you are using one) is hooked through the cable strain relief hook (Fig 5).
- Before switching on, ensure that the mower is not in contact with any foreign objects.
- To switch on, press the safety lock-off button **7** on the handle, then activate the start/stop switch lever **2**. Release the lock-off button **7**.
- To switch off, release the start/stop switch lever **2**.
- Start cutting once the mower has reached full speed.



Note! There are two start/stop switch levers fitted, either one can be used for starting the product.



After switching off the equipment, the blade may continue to turn for several seconds. Do not touch the moving blade. There is a risk of serious injury.

Operating Instructions & Tips

Operation

Before you connect the equipment to the mains supply make sure that the data on the rating plate corresponds to your mains supply.



IMPORTANT! Always ensure the on/off switch is working correctly. Do not use if you suspect a fault. Before you perform any repair or maintenance work on the machine, ensure that the plastic cutter is not rotating and that the power supply is disconnected.



IMPORTANT! Never empty the grass box if the motor is still running. The rotating plastic cutter can cause serious injuries and throw objects out at high speed.

Always ensure grass box fits securely. Always switch off the motor before you remove it.

A safe distance between the blade deck and the user is provided by the length of the handle. This distance must be maintained at all times. Take special care when mowing and changing direction on embankments and slopes. Ensure that you have a secure surface to stand on, wear shoes with anti-slip soles that offer good grip, and long trousers. Always mow across the slope (not in up or down direction).

Do not use the mower on gradients exceeding 15° for safety reasons.

Take special care when moving backwards and pulling the hover mower. Never pull the mower backwards when the motor is running.

Emptying the grassbox

11



12



- Stop the product and wait until the cutting head has stopped rotating before emptying the grassbox
- Lift up the grassbox lid **10**.
- Lift the grassbox **6** off the product and empty.
- Replace the grass box **6** securely and ensure the retaining hooks are correctly located in the recesses on the mower. Lower the lid **10** back onto the grass box **6**.

Failure to fit the grassbox and lid correctly will cause poor collection of grass clippings.

Operating Instructions & Tips

Mowing Advice

Cut your grass twice a week during the growing season, your lawn will suffer if more than a third of its length is cut at one time.

Keep the under side of the mower casing clean and remove all grass deposits from it. Deposits make it more difficult to start the mower and also adversely affect the mowing quality and the grass collection. Switch off the motor before you carry out any inspections of the cutting head. Remember that the cutting head will continue to turn for a few seconds after the motor has been switched off. Never attempt to stop the cutting head.

The cutting system must be kept in good condition and inspected before and after use. Switch off the motor before you carry out any inspections of the cutting system. Remember that the cutting head will continue to turn for a few seconds after the motor has been switched off. Never attempt to stop the cutting head.

Check plastic cutters for wear and replace when necessary. Plastic cutters should be straight, replace if bent or twisted.

Place the mains lead in loops on the ground near the wall socket. Mow away from the socket and cable and ensure that the mains lead is always on the section of lawn that you have already mowed so that you do not run over the mains lead with the mower.

If you see the grassbox is full whilst you are mowing, you should stop the mower and empty the grassbox.



IMPORTANT! Before you remove the grassbox, switch off the motor and wait until the cutting head reaches a complete standstill.

If any grass drops onto the ground you need move the mower away from the area to make it easier to re-start the motor.

Do not remove grass cuttings in the mower casing or on the cutter by hand or with your feet. Instead use suitable tools such as a brush or broom. To ensure efficient grass collection the grass collector should be cleaned after use. This will ensure the air is able to flow freely through it for best grass collection performance.

Only fit the grassbox when the motor is switched off and the cutting head is not moving.

Maintenance

Cleaning & Maintenance

Always disconnect the mains power plug before engaging in any cleaning work.

Cleaning

- Remove grass from under the deck with a piece of wood or similar.
- Using a soft brush remove grass clippings from all ventilation openings, the roller, grassbox and grassbox lid.
- Remove the cutting head, to gain access to the fan and clean with a soft brush.
- Wipe over the surface of your product with a dry cloth.

IMPORTANT! Always wear work gloves when engaging in any maintenance work.

Never use water or cleaning your product. Do not clean with chemicals, including petrol, or solvents some can destroy critical plastic parts.

Maintenance

Blade Maintenance

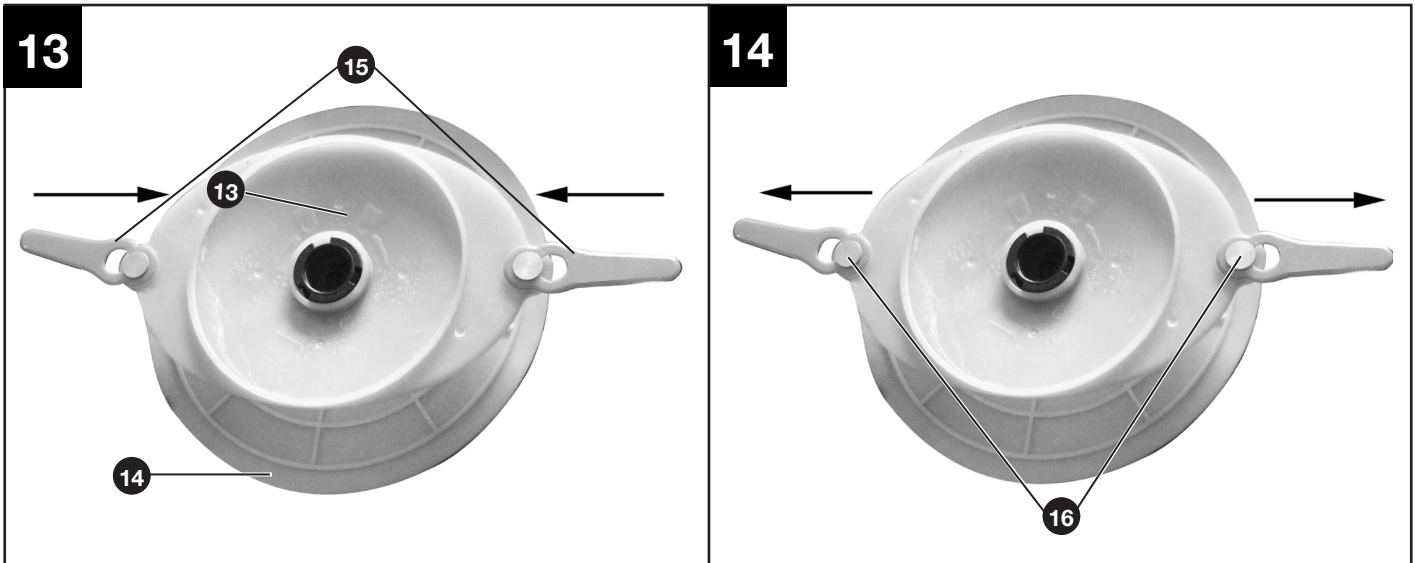

Always handle the plastic blades with care, sharp edges could cause injury. Use gloves.

Plastic blades will wear over time or may break if they hit a solid object. Always replace blades in pairs when worn or broken.

Carry out the following steps to change the plastic blades:

- Disconnect from the mains electricity supply and wait until the cutting head **13** has stopped rotating.
- Turn the mower over and rest it carefully on its side.
- Push the plastic blade **15** towards centre of cutting head **13**. (Fig.14) Lift the plastic blade away from cutting head
- If a plastic blade **15** has broken during operation remove both blades and replace them immediately. Always replace blades in pairs.
- Fit new plastic blades into the slots **16** at each side of the cutting head and pull into place. (Fig.15)



Note! Plastic blades must be replaced in pairs to retain balance. Two plastic cutters of the same type should be fitted.



IMPORTANT! Ensure plastic cutters are correctly located. Never fit a metal bar blade to this product. If the blade has broken, it will be difficult to take it off by hand, or even may hurt your fingers, so it is necessary to wear gloves or other protective equipment to prevent harming your fingers.

Maintenance and Storage

- Replace plastic blades, bolts, nuts or screws, whenever necessary.
- Ask a technical servicing dealer to clean air filter thoroughly and carry out any other service or repairs required.
- Store in a dry place, out of reach of children.

Troubleshooting

General Troubleshooting

The following table provides solutions to common problems encountered with the mower.

Fault	Possible Cause	Solution
Mower does not start	No power at mains socket	Check the fuse, switch, socket, cable, wire and have any repairs carried out by a qualified electrician
	Defective on/off switch	Repair by a qualified technician required
	Worn carbon brushes	
	Defective motor	
Poor floatation	Fan is blocked by grass	Disconnect from mains and clean the deck and the fan.
Poor collection	Cut height too low	Raise the cutting height
	Grassbox fitted incorrectly	Fit the grassbox correctly
Excessive vibration	Plastic blades broken or missing	Replace plastic blades
	Plastic blades fitted incorrectly	Fit the plastic blades correctly

Technical Data

Technical Data Table

Specification	Value
Voltage	220-240V~ 50Hz
Power input	1100W
Motor speed	8300 min ⁻¹
Cutting width	29 cm
Cutting height adjustment	10 mm, 33 mm; 2 levels
Volume of grass collector	15 litres
Rear roller size	38 mm
Sound pressure level	87 dB(A) K=3 dB(A)
Sound power level	96 dB(A)
Vibration at the handlebars ahv	≤ 2.5 m/s ²
Insulation protection class	□ II

Disposal

Disposal and Recycling



Do not dispose with household waste.

Recycle products and components according to local legal requirements.

Getting Help

After sales helpline number: 0343 515 1906