

stroud scroll back pair chair

Assembly Instructions - Please keep for future reference

549/5737

539/8085

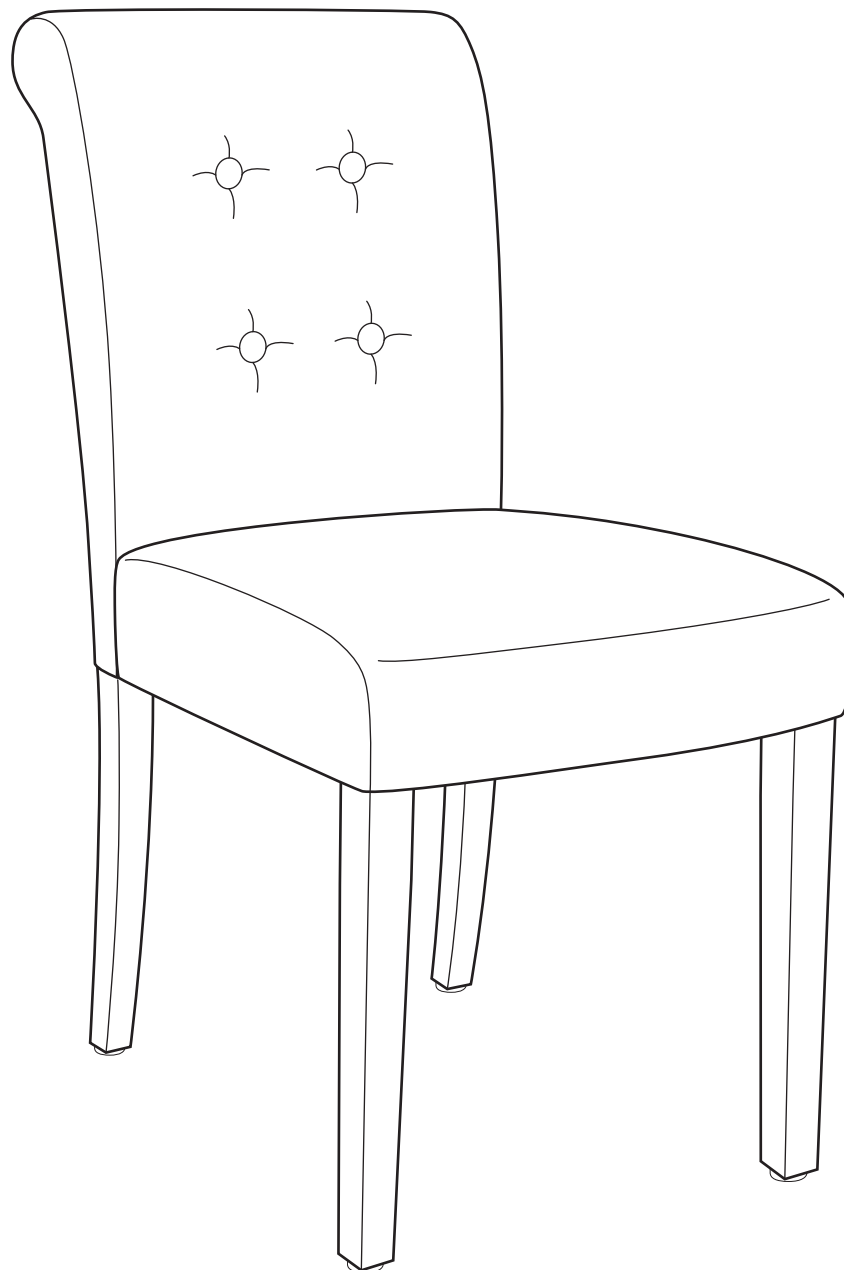

Dimensions

Width - 45.5 cm

Depth - 60.5 cm

Height - 89 cm

Important - Please read these instructions fully before starting assembly

If you need help or have damaged or missing parts, call the **Customer Helpline:**
Argos = 0345 640 0800



Safety and Care Advice

Important - Please read these instructions fully before starting assembly

- Check you have all the components and tools listed on the following pages.
- Remove all fittings from the plastic bags and separate them into their groups.
- Keep children and animals away from the work area, small parts could choke if swallowed.
- Make sure you have enough space to layout the parts before starting.

- During assembly do not stand or put weight on the product, this could cause damage.
- Assemble the item as close to its final position (in the same room) as possible.
- Assemble on a soft level surface to avoid damaging the unit or your floor.
- Parts of the assembly will be easier with 2 people.



• We do not recommend the use of power drill/drivers **for inserting screws**, as this could damage the unit. Only use hand screwdrivers.

- Unit weight: 6.3 kgs.
- Maximum safe weight of user: 110kgs.

Care and maintenance

- Only clean using a damp cloth and mild detergent, do not use bleach or abrasive cleaners.
- From time to time check that there are no loose screws on this unit.

- Do not stand on the chair.
- Do not use this chair as step ladder.
- This product should not be discarded with household

waste. Take to your local authority waste disposal centre.

Handy Hints

- Assemble all parts and bolts loosely during assembly, only once the product is complete should you fully tighten the bolts.
- Regularly check and ensure that all bolts and fittings are tightend properly.

Components - Parts

If you have damaged or missing components, call the Customer Helpline: Argos = 0345 640 0800

Please check you have all the parts listed below

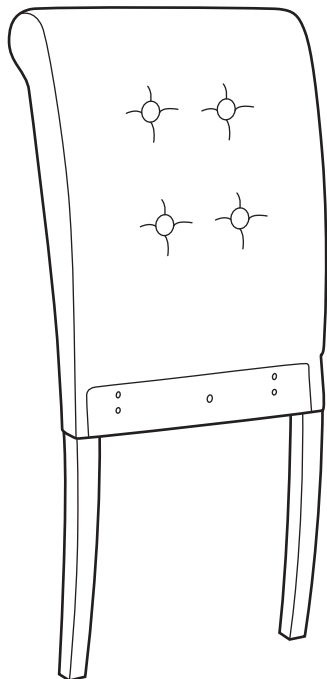

1 Backrest
(89 x 43 x 14.5cm)

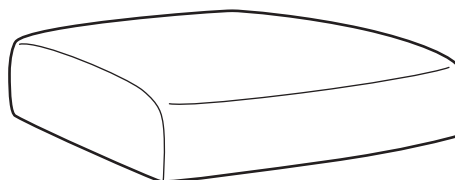

2 Seat
(45 x 43 x 10.5cm)







3 Leg x 2
(44 x 4/3 x 4cm)

Components - Fittings

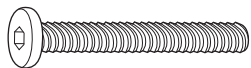
Please check you have all the fittings listed below

Note: The quantities below are the correct amount to complete the assembly. In some cases more fittings may be supplied than are required.

<p>A </p> <p>M6 x 50mm Bolt x 9</p>	<p>B </p> <p>Spring washer x 9</p>	<p>C </p> <p>Flat washer x 9</p>
<p>D </p> <p>Foot pad x 4</p>	<p>E </p> <p>Allen key x 1</p>	

Ruler - Use this ruler to help correctly identify the screws

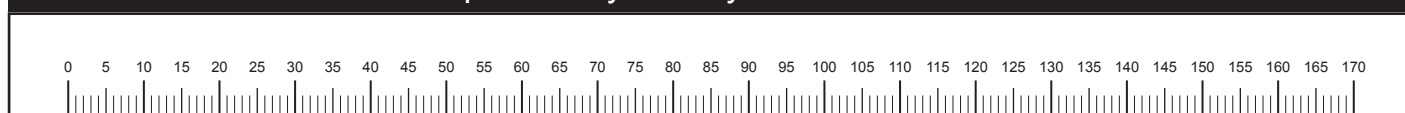

Assembly Instructions

Step 1

Attaching legs

Place the seat **2** upside down on a flat protected surface.

Insert the legs **3** into the holes of the seat as shown and fix using bolts **A**, spring washers **B** and flat washers **C**.



Important:

Fasten bolts using allen key **E** but do not fully tighten at this stage.

Use oval head of allen key on tight angles.

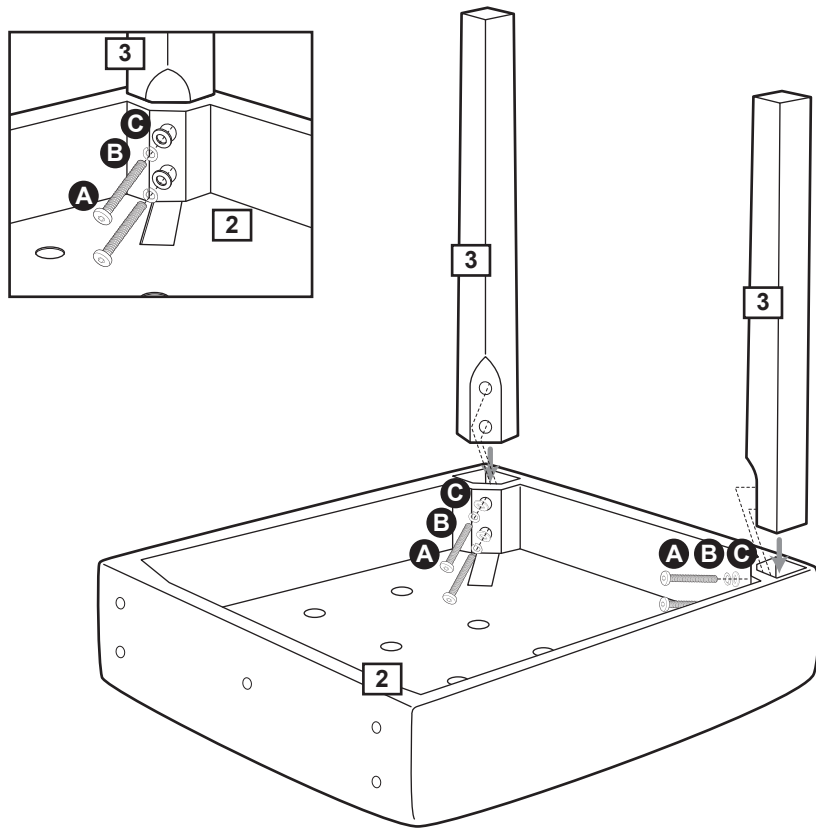

Step 2

Attaching the seat

Place the backrest **1** on a flat protected surface.

Position the seat **2** on the backrest **1** as shown and fix using bolts **A**, spring washers **B** and flat washers **C**.



Important:

Fasten bolts using allen key **E** but do not fully tighten at this stage.

Use oval head of allen key on tight angles.

Remove backing from foot pads **D** and carefully position on the bottom of the legs **1** & **3** as shown.

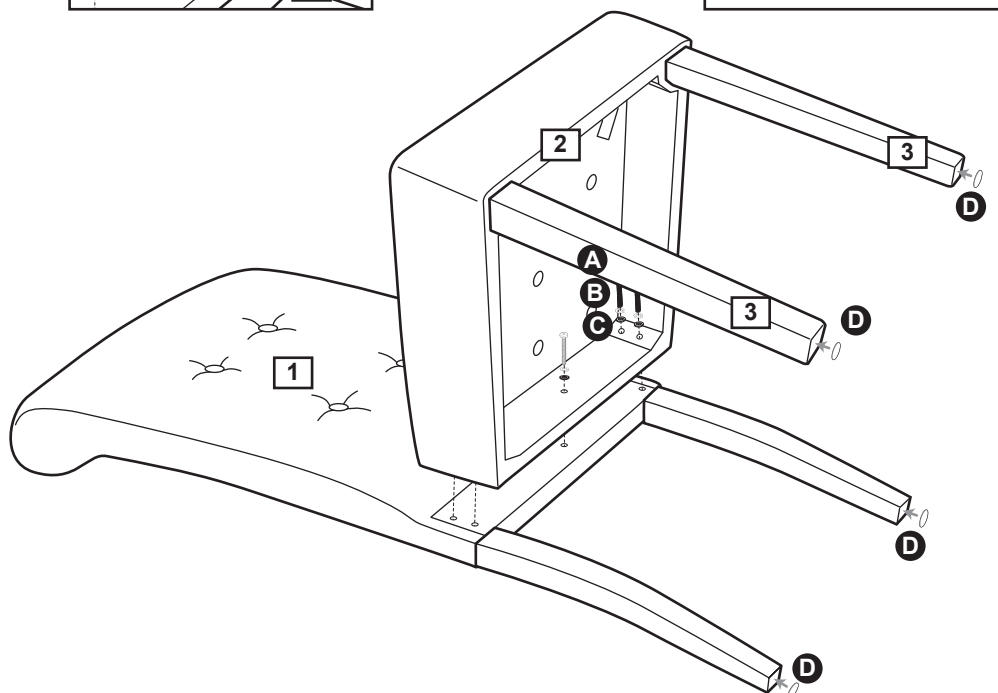
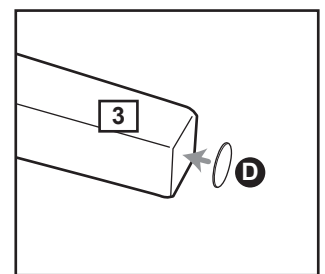
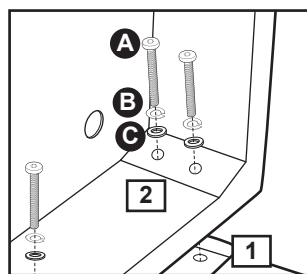

Assembly Instructions

Step 3

Aligning & securing the legs

Carefully turn the chair upright and place on a flat surface.

a: Tighten all bolts using allen key **E**.

Note:

Use oval head of allen key on tight angles.

Note: This step is essential to prevent the chair from wobbling due to uneven legs.

b: Carefully sit on the chair and make adjustments to ensure the legs are flat even on the floor.

c: After the sitting test, re-tighten bolts again if any adjustment is needed.

Note: It is highly recommended to re-tighten all bolts after using the chair for 7 days.

Note: Keep allen key to re-tighten bolts when required.

Assembly is complete.

a:

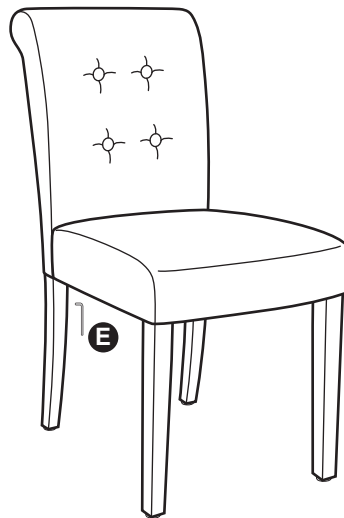

b:

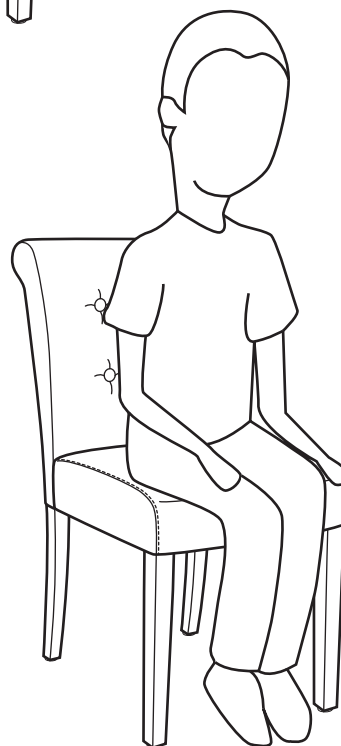

c:

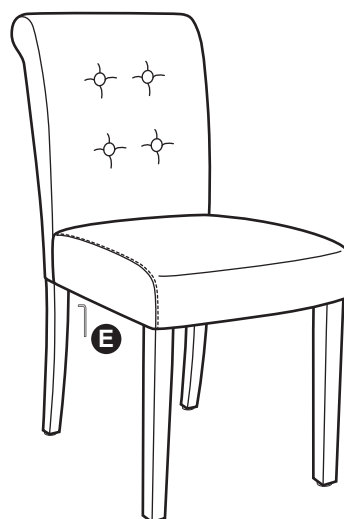

If you need help or have damaged or missing parts, call the **Customer Helpline:**
Argos = 0345 640 0800