

Components

A .1X Left Seat Cushion

B .1X Middle Seat Cushion

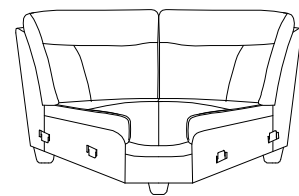
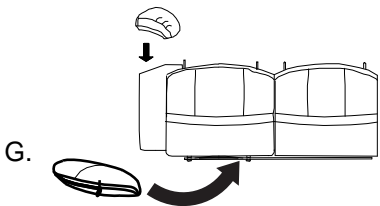

C .1X Right Seat Cushion

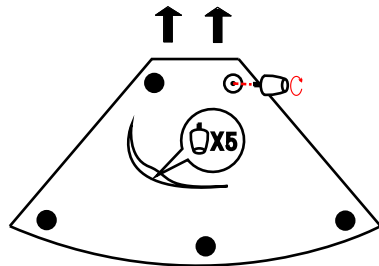
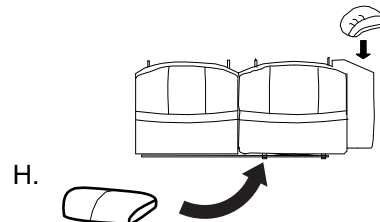

D .1X Left Back Rest

E .2X Middle Back Rest

F .1X Right Back Rest

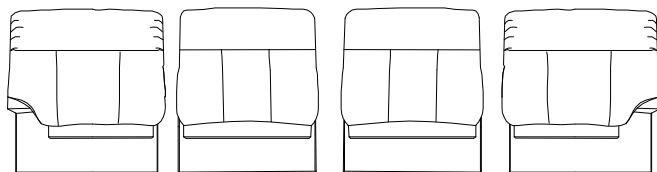

Velcro

G. 1 x Left Arm Cushion

H. 1 x Right Arm Cushion

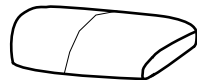

Fittings

Ⓜ 2x Mains Electricity Supply



TC NEW PAOLO CORNER POWERED

Simple Assembly Instructions—please keep for future reference

5432941

5659982

5493258

5386327

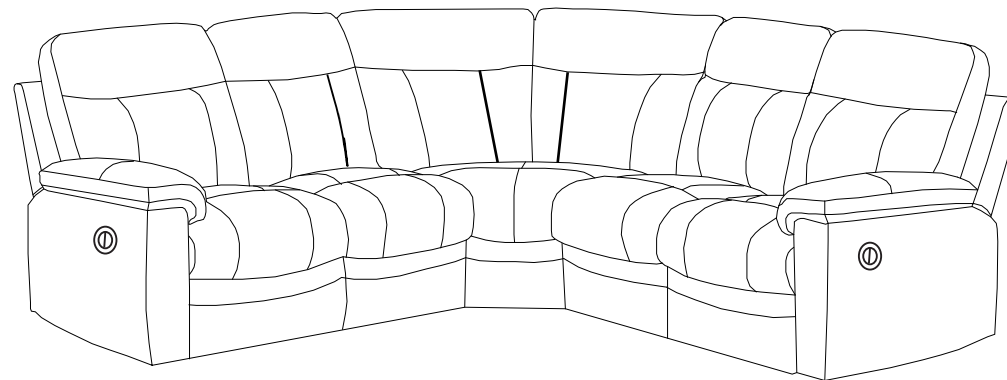

Important—Please read these instructions fully before starting assembly

If you need help or have damaged or missing parts, call the Customer Helpline: 0345 640 0800
0345 601 2895

1. Read these instructions carefully and familiarise yourself with the procedure before assembling the unit.
2. Check that you have all the component parts following the list on the back cover and familiarise yourself with each part before proceeding.
3. Take all the fitting out of the plastic bag and separate them into their groups.
4. Ensure you have enough space to lay out all the parts before assembly.
5. To avoid scratching it is recommended that you assemble the unit on a soft level surface.

Assembly Instructions

NOTE: It would be useful to ask someone to help you at this stage.

1. Carefully combine the Left Seat A together with Back cushion D and E.

The arm cushion package is tied inside the bottom of sofa. Please get the arm cushion (G) for assembly. See fig.1.

Firstly attach the arm cushion. you can find the assembly steps in the last page.

2. Engage the Metal Locks push them together until you hear them lock into position. See fig.2.

3. Repeat the same above 2 steps for right seat.

See fig.3.

The arm cushion package is tied inside the bottom of sofa. Please get the arm cushion (H) for assembly.

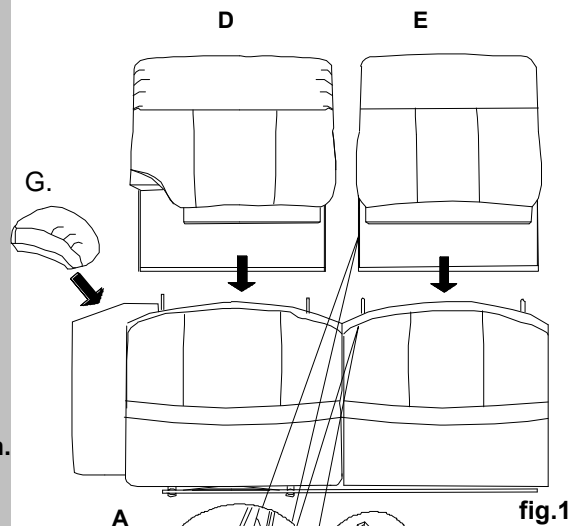

fig.1

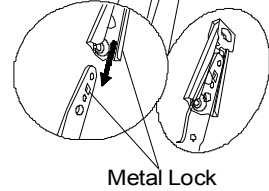

fig.2

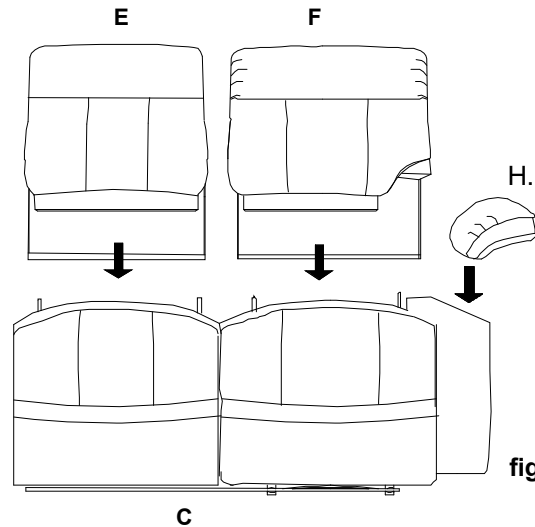

fig.3

Assembly Instructions

NOTE: It would be useful to ask someone to help

4. Attach the center unit on left unit, Then engage the metal locks.

See fig.4.

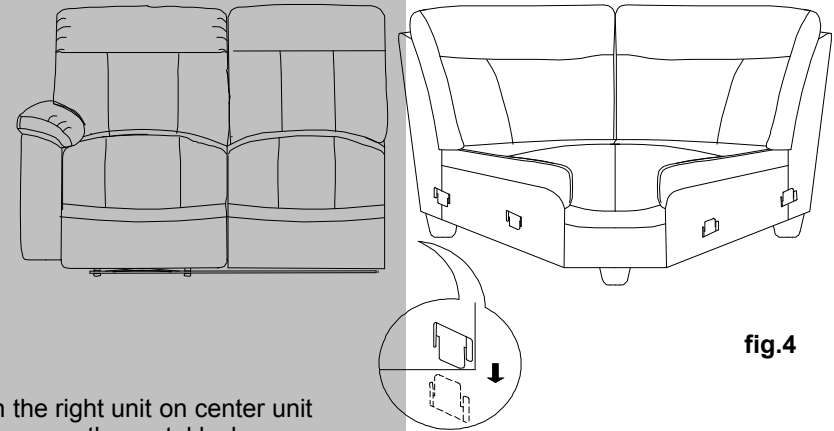

fig.4

5. Attach the right unit on center unit Then engage the metal locks.

See fig.5.

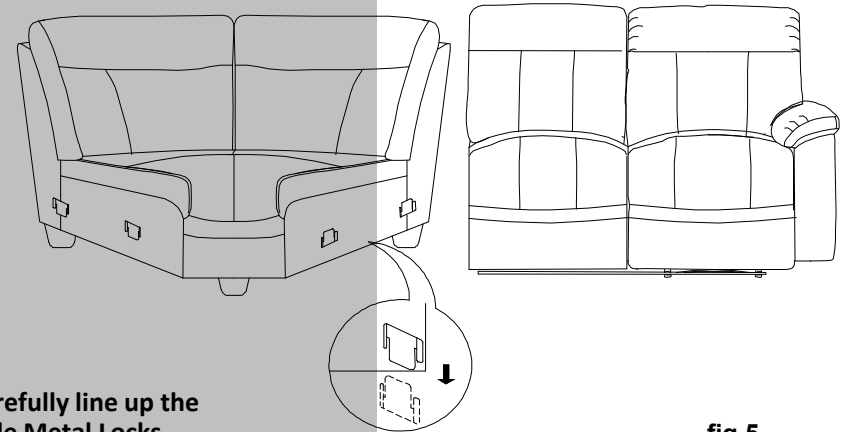

fig.5

NOTE: Carefully line up the two side Metal Locks. Ensure they align correctly.

⚡ WARNING: If the supply cord is damaged, it must be replaced by the manufacturer, its service agent or similarly qualified persons in order to avoid a hazard.

6. Remove and unpack the fittings which are stored under the Seat Unit **(A)(C)**.
See **fig.6**.

NOTE: It would be useful to ask someone to help you at this stage.

Back and Foot Rest Adjustment

This Chair features a reclining back rest and raised foot rest. You need to be sitting in the chair to activate the features.

7. Back and Foot Rest Adjustment

① Press the "Adjustment Lever-front button", the chair will recline and the foot rest will automatically lift up.

See **fig.6**.

② Press the "Adjustment Lever-back button". The sofa return to the normal position.

See **fig.6**.

③ Adjust the recliner to your own requirements.

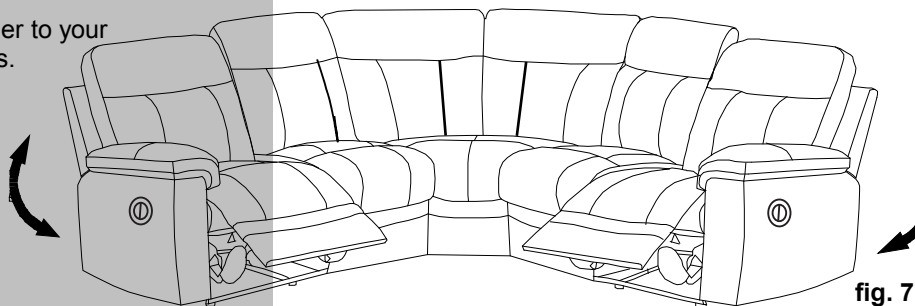

fig. 7

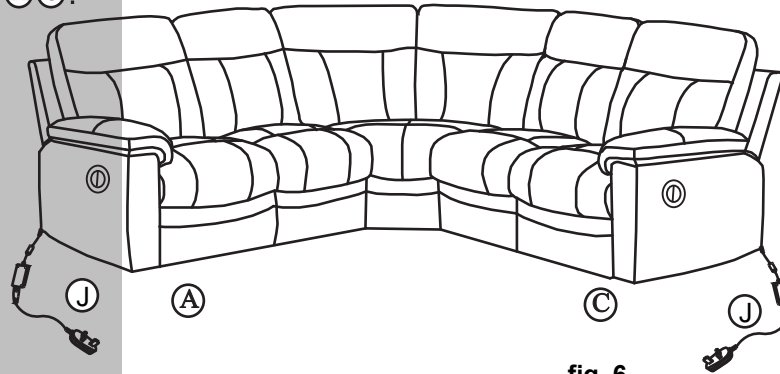

fig. 6

8. Finally carefully place the unit in the desired location.

See **fig.8**.

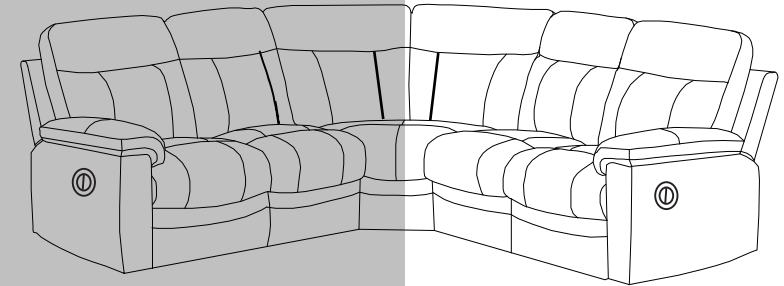

fig.8



CAUTION:

Beware of entrapment. Keep hands and fingers clear of the Tilt Mechanism when operating the controls. Ensure that children or pets are not playing or lying in the way when the Tilt Mechanism is operated. Prevent children from playing on the furniture or with the controls.



WASTE ELECTRICAL PRODUCTS SHOULD NOT BE DISPOSED OF WITH HOUSEHOLD WASTE. PLEASE RECYCLE WHERE FACILITIES EXIST. CHECK WITH YOUR LOCAL AUTHORITY FOR RECYCLING ADVICE.

NOTE: It would be useful to ask someone to help you at this Stage.

Care and Maintenance

Safety

To avoid any risk of suffocation to animals or children dispose of the plastic bags immediately.

Cleaning

As with all surfaces clean with a damp cloth and mild detergent, do not use bleach or abrasive products.

Fitting

From time to time please ensure there are no loose screws on the product. if you need help or have damaged or missing parts, call the Customer Helpline:

0345 640 0800/0345 601 2895

489-499 Avebury Boulevard Milton Keynes MK9 2NW, Argos Limited

Arm cushion assembly steps

1. Please fix the arm cushion by zipping it onto the outside of the armrest.

See fig. 8.



fig. 8

2. Adjust the arm cushion with the right position onto the armrest .

See fig.9.



fig. 9

3. Press the seat cushion next to the inside of armrest. then stick the velcro into the inside of armrest.

See fig. 10.



fig. 10