

TUMBLE DRYER



English

TCHL 83

TCHL 780

Contents

GB

Installation, 2

Warnings, 3

Care and Maintenance, 5

Control panel, 7

Start and Programmes, 8

Laundry, 10

Troubleshooting, 11

Service, 12

www.hotpoint.eu

 This symbol reminds you to read this instruction manual.

! Keep this manual at hand for immediate reference whenever necessary. Always store this manual close to the tumble dryer and remember to pass it on to any new owners when selling or transferring the appliance, so they may familiarise with the warnings and suggestions herein contained.

! Read these instructions carefully: the following pages contain important information on installation and useful suggestions for operating the appliance.

Installation

GB

Where to install the tumble dryer

• Install the dryer far from gas ranges, stoves, radiators or hobs, as flames may damage it. If the dryer is installed below a worktop, ensure there are 10 mm between the upper panel of the dryer and any objects above it, and 15 mm between the sides of the machine and the walls or furniture units adjacent to it. This ensures adequate air circulation. The appliance must be installed with the rear surface placed against a wall.

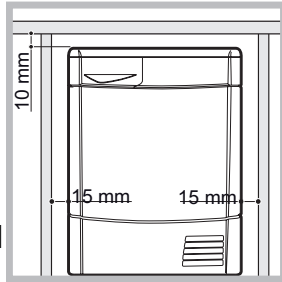

Ventilation

• The room must be adequately ventilated while the dryer is running. Make sure that the dryer is installed in a room free of humidity and with adequate air circulation. The flow of air around the dryer is essential to allow water to condense during drying; the dryer will not function properly if it is placed in an enclosed space or inside a cabinet.

! Some condensation may form if the dryer is used in a small or cold room.

! We do not recommend that the dryer is installed in a cupboard but the dryer must never be installed behind a lockable door, a sliding door or a door with a hinge on the opposite side to that of the dryer door.

Water drain

If your dryer is installed next to a drain the water can be plumbed into this drain. This does away with the need to empty the water container. If the dryer is stacked onto or installed next to a washing machine it can share the same drain. The height of the drain must be less than 3' (1 m) from the bottom of the dryer.

Remove existing hose from position shown in picture A and fit a suitable length of hose and connect as shown in picture B.

! The drain tube has to be below 1 m from the bottom of the Dryer

! Make sure that the hose is not squashed or kinked when the dryer is in its final location.

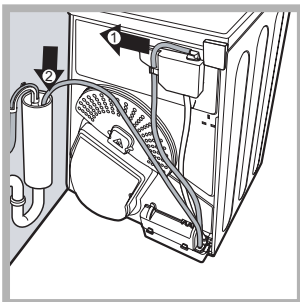

Picture A

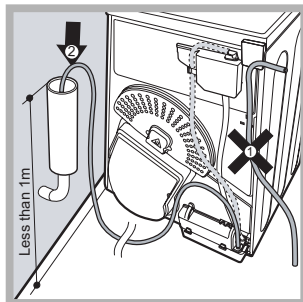

Picture B

Electrical connections

Before plugging the appliance into the socket, check the following:

- Make sure your hands are dry.
- The socket must have an earth connection.
- The socket must be able to withstand the machine's maximum power output as indicated on the rating plate.
- The power supply voltage must fall within the values indicated on the data plate.
- The socket must be compatible with the dryer's plug. Should this not be the case, replace the plug or the socket.

! DO NOT USE EXTENSION CORDS.

! The dryer must not be installed outdoors, even if the space is sheltered. It can be very dangerous if exposed to rain or storms.

! Once installed, the dryer's electrical wire and plug must be within reach.

! The power cord must not be bent or squashed.

! If the plug being replaced is a non-rewirable type, then the cut-off plug must be disposed of safely. DO NOT leave it where it can be inserted into a socket and create a shock hazard.

! The power must be regularly checked. If the supply cord is damaged, it must be replaced by the manufacturer, its service agent or similarly qualified persons in order to avoid a hazard. (see Assistance). New or longer electric cords are supplied by authorised dealers at a supplementary cost.

! The manufacturer denies any responsibility should any of these rules not be followed.

! If in doubt about any of the above consult a qualified electrician.

Preliminary information

Once the tumble dryer is installed, clean the inside of the drum before operating it and remove any dirt accumulated during transportation.

! This appliance has been designed and built according to international safety standards. These warnings are given for safety reasons and must be followed carefully.

General safety

- This appliance can be used by children aged from 8 years and above and persons with reduced physical, sensory or mental capabilities or lack of experience and knowledge if they have been given supervision or instruction concerning use of the appliance in a safe way and understand the hazards involved.
- This tumble dryer has been designed for home, and not professional, use.
- Do not touch the appliance while barefoot or with wet hands or feet.
- Unplug the machine by pulling on the plug, not the cord.
- After using the dryer, turn it off and unplug it. Keep the door closed to make sure that children do not use it as a toy.
- Children should be supervised to ensure that they do not play with the dryer.
- Cleaning and user maintenance shall not be made by children without supervision.
- Children of less than 3 years should be kept away from the appliance unless continuously supervised.
- The appliance must be installed correctly and have proper ventilation. The air intake at the front of the dryer should never be obstructed (see *Installation*).
- Never use the dryer on carpeting where the pile height would prevent air from entering the dryer from the base.
- Check to see if the dryer is empty before loading it.
-  The back of the dryer could become very hot. Never touch it while in use.
- Do not use the dryer unless the filter, water container and condenser are securely in place (see *Maintenance*).
- Do not overload the dryer (see *Laundry* for maximum loads).
- Do not load items that are dripping wet.
- Carefully check all instructions on clothing labels (see *Laundry*).
- Do not tumble dry large, very bulky items.
- Do not tumble dry acrylic fibres at high temperatures.
- Do not turn off the dryer when there are still warm items inside.
- Clean the filter after each use (see *Maintenance*).
- Empty the water container after each use (see *Maintenance*).
- Clean the condenser unit at regular intervals (see *Maintenance*).
- Do not allow lint to collect around the dryer.
- Never climb on top of the dryer. It could result in damage.
- Always follow electrical standards and requirements (see *Installation*).
- Always buy original spare parts and accessories (see *Service*).

To minimise the risk of fire in your tumble dryer, the following should be observed:

- Tumble dry items only if they have been washed with detergent and water, rinsed and been through the spin cycle. It is a fire hazard to dry items that HAVE NOT been washed with water.
- Do not dry garments that have been treated with chemical products.
- Do not tumble dry items that have been spotted or soaked with vegetable or cooking oils, this constitutes a fire hazard. Oil-affected items can ignite spontaneously, especially when exposed to heat sources such as a tumble dryer. The items become warm, causing an oxidation reaction with the oil. Oxidation creates heat. If the heat cannot escape, items can become hot enough to catch fire. Piling, stacking or storing oil-affected items can prevent heat from escaping and so create a fire hazard. If it is unavoidable that fabrics containing vegetable or cooking oil or those that have been contaminated with hair care products be placed in a tumble dryer they should first be washed with extra detergent - this will reduce, but not eliminate the hazard. They should not be removed from the dryer and piled or stacked while hot.
- Do not tumble dry items that have previously been cleaned in or washed in, soaked in or soiled with petrol/gasoline, dry cleaning solvents or other flammable or explosive substances. Highly flammable substances commonly used in domestic environments including cooking oil,

acetone, denatured alcohol, kerosene, spot removers, turpentine, waxes and wax removers. Ensure these items have been washed in hot water with an extra amount of detergent before being dried in the tumble dryer.

- Do not tumble dry items containing foam rubber (also known as latex foam), or similarly textured rubber like materials. Foam rubber materials can, when heated, produce fire by spontaneous combustion.
- Fabric softener or similar products should not be used in a tumble dryer to eliminate the effects of static electricity unless the practice is specifically recommended by the manufacturer of the fabric softener product.
- Do not tumble dry undergarments that contain metal reinforcements eg. bras with metal reinforcing wires. Damage to the tumble dryer can result if the metal reinforcements come loose during drying.
- Do not tumble dry rubber, plastic articles such as shower caps or babies waterproof covers, polythene or paper.
- Do not tumble dry rubber backed articles, clothes fitted with foam rubber pads, pillows, galoshes and rubber coated tennis shoes.
- Remove all objects from pockets such as lighters and matches.

! WARNING: Never stop the dryer before the end of the drying cycle unless all items are quickly removed and spread out so that the heat is dissipated.

Save energy and respect the environment

- Wring out all items to eliminate excess water before tumble drying (if you use a washing machine first, select a high spin cycle). Doing this will save time and energy during drying.
- Always dry full loads - you save energy: single items or small loads take longer to dry.
- Clean the filter after each use to contain energy consumption costs (see *Maintenance*).

Maximum load sizes: 8 kg

Product Data - Regulation 392/2012.	
Brand	
Hotpoint	
Model	TCHL 83B RG (UK) TCHL 83B RP (UK) TCHL 780BP (UK)
Rated capacity of cotton laundry for the "standard cotton programme" at full load - kg	8.0
This household tumble drier is a	Condenser
Energy efficiency class on a scale from A+++ (low consumption) to D (high consumption)	B
The weighted Annual Energy Consumption (AEc)* kWh 1)	560
This household tumble drier is a	Automatic
Energy consumption full load; Edry - kWh 2)	4.77
Energy consumption partial load; Edry½ - kWh 2)	2.53
Power consumption: off-mode (Po) - Watts	0.14
Power consumption: left-on mode (Pl) - Watts	1.9
Duration of the 'left-on mode' for power management system - minutes	30
Prog. Time - weighted (Tt) full & partial load - minutes 3)	104
Full load (Tdry) - minutes	139
Partial load (Tdry½) - minutes	78
Condensation efficiency class on a scale from G (least efficient) to A (most efficient)	B
Average condensation efficiency - %	
weighted (Ct) full & partial load 3)	81
full load (Cdry)	82
partial load (Cdry½)	80
Airborne acoustical noise emissions - dB(A) re 1 pW	68
1) "Standard cotton" at full and partial load is the standard programme to which the information in the label and the fiche relates. The standard cotton program is suitable to dry at cupboard level (0%) cotton laundry and is the most efficient programme in terms of energy consumption. Partial load is half the rated load.	
2) based on 160 drying cycles of the standard cotton programme at full and partial load, and the consumption of the low-power modes. Actual energy consumption will depend on how the appliance is used.	
3) Weighted average of 3 cycles at full load and 4 cycles at half load.	
Regulation 932/2012.	
Energy consumption in kWh, for program "Synthetics" full load	1.41
Programme time in minute, for program "Synthetics" full load	65
Partial load for program "Synthetics" N/A	

Care and maintenance

Disconnecting the power supply

! Disconnect the dryer when not in use or during cleaning and maintenance operations.

Cleaning the filter after each cycle

The filter is a fundamental component of the dryer: its function is to collect lint and fluff that form during drying. Clean the filter once drying is completed, by rinsing it under running water or cleaning it with a vacuum cleaner. Should the filter become clogged, the flow of air inside the dryer will be

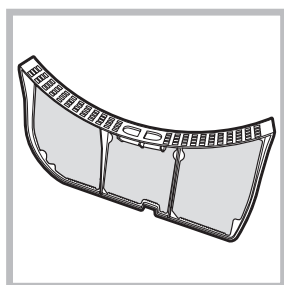

seriously hampered: drying times becomes longer and more energy is consumed. Also, the dryer may become damaged.

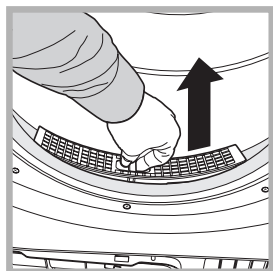

The filter is located in front of the dryer seal (see Picture).

Removing the filter:
1. Pull the filter's plastic handle upwards (see

Picture).

2. Clean the fluff off the filter and replace it correctly. Ensure that the filter is pushed fully home.

! Do not use the dryer unless the filter has been replaced in its holder.

Checking the drum after each cycle

Rotate the drum manually to remove smaller items (handkerchiefs) that could have been left inside the dryer.

Cleaning the drum

! Avoid using abrasives, steel wool or stainless steel cleaning agents to clean the drum. A coloured film may appear on the stainless steel drum surface: it may be caused by a combination of water and/or cleaning agents such as wash-

softeners. This coloured film does not affect the dryer's performance.

Emptying the water container after each cycle

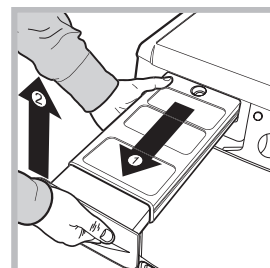

Remove the water container and empty it into a sink or other suitable drain outlet, then replace it correctly. Always check the water container and empty it before starting a new drying cycle.

-Failure to empty the water container may cause the following:

- The dryer stops heating (so the load may still be damp at the end of the drying cycle).
- The "Empty water container" LED activates to show that the water container is full.

Priming the Water Collection System

When your dryer is new, the Water Container will not collect Water until the system is primed, this will take 1 or 2 drying cycles. Once primed it will collect Water during every cycle.

Cleaning the condenser unit.

- Remove the condenser (see Picture below) unit regularly (monthly) and clean off any fluff deposits from the plates by rinsing it with cold water running on the rear end of the condenser.

Removing the condenser:

1. Disconnect the dryer from the power supply and open the door.

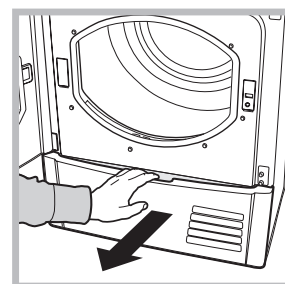

2. Open the condenser cover (see Picture below), unlock the three catches by turning them 90° anti-clockwise, then pull on the grip to remove the condenser.

3. Clean the surface of the seals and replace the unit with the arrows pointing upwards, whi-

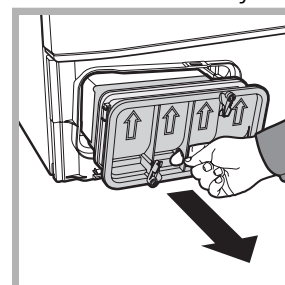

le making sure that the catches are securely fixed.

Cleaning the tumble dryer

- The external metal, plastic and rubber parts can be cleaned with a damp cloth.
- Clean the front air intake grille regularly (every 6 months) with a vacuum cleaner to remove any lint, fluff or dust deposits. Furthermore, remove any lint deposits from the front part of the condenser and from the filter area, using a vacuum cleaner every so often.

! Do not use solvents or abrasives.

! Have the dryer checked regularly by authorised technical personnel in order to ensure that the electrical and mechanical parts work safely (see Assistance).

Quick Tips

! Remember to clean your filter and Condenser unit after each load.

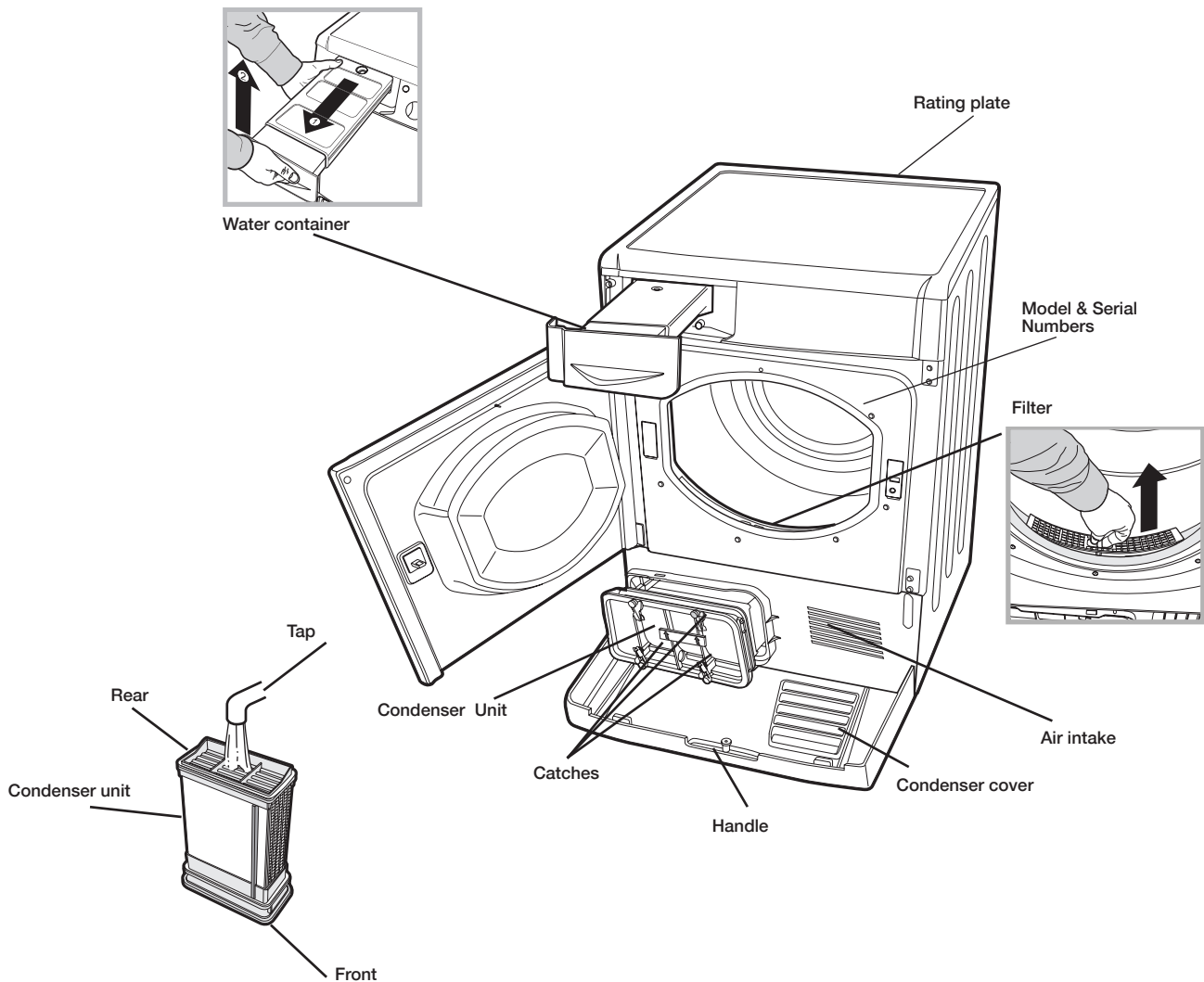

! Remember to empty your water container after each load.

! Doing this will keep your machine working at its BEST!

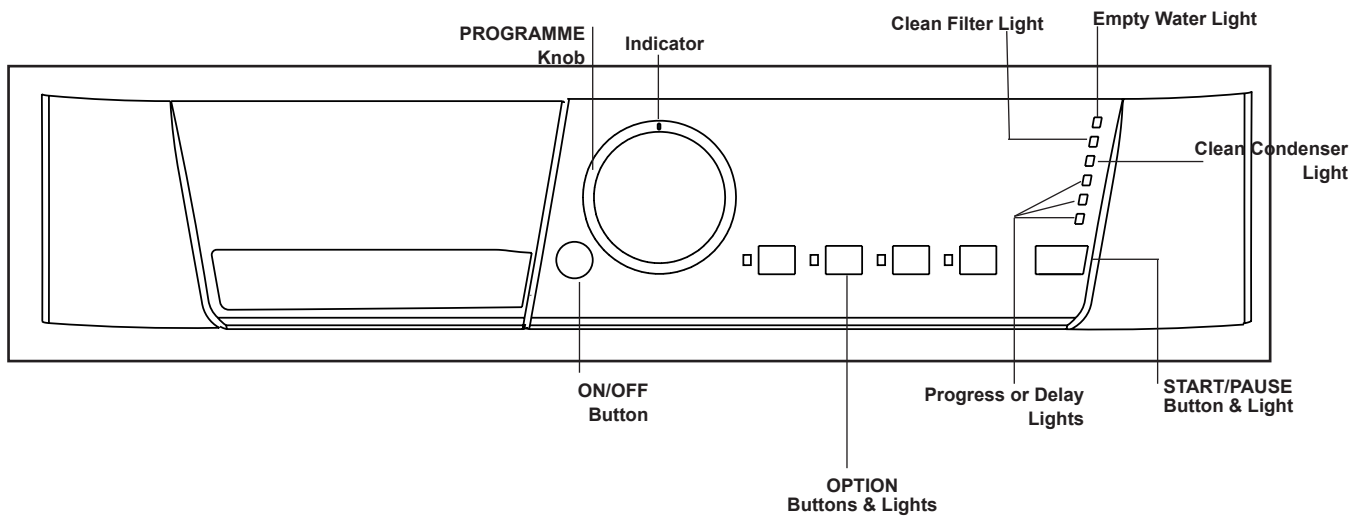



Choosing a programme

1. Plug the dryer into the electrical socket.
 2. Sort your laundry according to fabric type (see *Laundry*).
 3. Open the door and make sure the filter is clean and in place and the water container is empty and in place (see *Maintenance*).
 4. Load the machine and make sure items are not in the way of the door seal. Close the door.
 5. If none of the lights are on: Press the ON/OFF button .
 6. Choose a programme by checking the Programmes Guide (see *Programmes*) as well as the indications for each type of fabric (see *Laundry*).
 - Select a programme by rotating the PROGRAMMES knob.
 7. Set a delay time and other options if necessary.
 8. The START/PAUSE light is flashing green:
 - press the START/PAUSE  button to begin. The green light stops flashing.
- During the drying programme, you can check on your laundry and take out items that are dry while others continue drying. When you close the door again, press the START/PAUSE button in order to resume drying. (When the door is opened the START/PAUSE light will flash Amber, after the door is closed and the START/PAUSE  button pressed, the START/PAUSE light

will stop flashing and show green.)

Note: During the Post Care phase this light flashes Amber.

9. At the end of the drying cycle the End light come on and either :
 - The buzzer will beep 3 times to let you know that your programme is complete.
 - or - If you have selected the Crease Care option and you do not take the items out immediately, the items will tumble occasionally for 10 hours or until you open the door, the buzzer will then beep 3 times to confirm the programme is completed.
10. Open the door, take the laundry out, clean the filter and replace it. Empty the water container and replace it (see *Maintenance*).
11. Unplug the dryer.

Start and Programmes

GB

The Controls

• PROGRAMMES knob

! Warning, if after pressing the Start/Pause button >||, the programmes knob position has changed, the new position will NOT change the programme selected. To change a selected programme, press the Start/Pause button >||, the light flashes Amber to indicate the programme is paused. Select the new programme and any options required, the light will then flash green. Press the Start/Pause button >|| again and the new programme will start.

• Option buttons / lights

These buttons are used to customise the selected programme to your requirements. Not all options are available for all programmes (see Start and Programmes). If an option is not available and you press the button, the buzzer will beep three times. If the option is available the option light next to the button lights to confirm the selection.

Progress (Drying, Cool Tumble, End) /Delay (3hr, 6hr, 9hr) Lights

When the light next to the delay button is on, these lights flash to indicate the delay time selected. During other programmes they indicate the progress of the dryer, each one comes on as the corresponding phase starts.

Delay Timer

The start of some programmes (see Start and Programmes) can be delayed for up to 9 hours in 3hr steps. Ensure the water bottle is emptied before setting a delayed start. When a delayed start is in progress the light next to the delay button will be on and the selected delay period light will flash (after the start button has been pressed). To set a delayed start, press the Delay Timer button, and the light next to the button will come on together with the 3hr delay light. Pressing the button again will advance the delay setting to 6hr, the 3hr light goes out and the 6hr light is on. Each time you press the button the delay setting advances 3 hours, as indicated by the corresponding light. If the 9hr light is on, pressing the button again will cancel the delay. Holding in the On/Off button will also cancel.

Pre Care

When a delayed start and this option have been selected the clothes are tumbled occasionally during the delayed period to help prevent creases developing.

High Heat

Available for Timed Drying Programmes. Press this button and a high heat setting is selected and the light next to the button comes on. Timed programmes have a default of low heat, if the light alongside the button is on then pressing the button selects a low heat setting and the light goes out.

Post Care

When selected, the clothes are occasionally tumbled after the end of the drying and cool tumble cycles, to help prevent creases developing should you not be available to remove the load immediately the programme is complete. The End light is on during this phase.

Empty Water Light / Container

(If you have plumbed your dryer to a drain this light can be ignored, as there is no need to empty the water container). When this light is on (not flashing) it reminds you to empty the water container. If the water container fills during a programme, the heater turns off and the dryer does a period of Cool Tumble then the light flashes and the buzzer sounds. You must empty the water container and restart the dryer or the clothes will not dry. After re-starting the dryer, the

light will take a few seconds to go out. To avoid this always empty the water container each time you use the dryer (see Maintenance).

• Door Opening

Opening the door (or pressing the Start/Pause button >||) during a programme will stop the dryer and have the following effects:











- The Start/Pause light flashes Amber.
- During a delay phase the delay will continue to count down. The Start/Pause button >|| **must** be pressed to resume the delay programme. One of the delay lights will flash to show the current delay setting.
- The Start/Pause button >|| **must** be pressed to resume the programme. The progress lights will change to show the current status and the Start/Pause light will stop flashing and turn green.
- During the Post Care phase of a drying programme, the programme will finish. Pressing the Start/Pause button >|| will re-start a new programme at the beginning.
- Changing the programmes knob will select a new programme and the Start/Pause light will flash green. You can use this to select the Cool Tumble programme  to cool the clothes, if you find them dry enough. Press the Start/Pause button >|| to begin a new programme.

• Note

If you have a power cut, switch off the power or remove the plug. When power is restored, press and hold the ON/OFF button until the dryer reactivates, then press the Start/Pause button.

Programmes

! If none of the lights are lit; Press the ON/OFF button  and then select programme.

Programme	What it does...	How to set it..	Note:
1  Cottons Ready to Wear	Dries your clothes on High Heat setting, ready for wearing.	1. Position the PROGRAMMES knob on  . 2. Select any options if required. 3. Press the Start/Pause button > 	Options available: Delay Timer Pre Care Post Care
2  Standard Cotton	Dries your clothes on High Heat setting, ready for putting away.	1. Position the PROGRAMMES knob on  . 2. Select any options if required. 3. Press the Start/Pause button > 	Options available: Delay Timer Pre Care Post Care
3  Synthetics Cupboard dry	Dries your clothes on Low Heat setting, ready for putting away	1. Position the PROGRAMMES knob on  . 2. Select any options if required. 3. Press the Start/Pause button > 	Options available: Delay Timer Pre Care Post Care
4  Easy Iron	Brief programme (approximately 10 minutes) that softens fibres of clothing that is ready for ironing.	1. Position the PROGRAMMES knob on  . 2. Press the Start/Pause button > 	! This is not a drying programme (see previous page). Options available: None
5  Cool Tumble	Brief programme (approximately 10 minutes) that cools fibres of clothing.	1. Position the PROGRAMMES knob on  . 2. Press the Start/Pause button > 	Options available: None
Timed Drying (150, 140, 120, 100, 80, 70, 60, 50, 40, 30 or 20 minutes)	Dries wet clothing that you wish to dry on Low Heat or small loads (less than 1kg). Can be used with High Heat option if you prefer to use a timed programme.	1. Position the PROGRAMMES knob on the desired time: 150, 140, 120, 100, 80, 70, 60, 50, 40, 30 or 20. 2. Select any options if required. 3. Press the Start/Pause button > 	Options available: High Heat Delay Timer Pre Care Post Care Consult 'suggested drying times' (see <i>Laundry</i>). The last 10 minutes of these programmes is the Cool Tumble phase.

2 Standard Cotton

- This is a programme for cotton items.
- The duration of this programme will depend on the size of the load, the dryness setting selected and the spin speed used in your washer (see *Laundry*).
- The Standard Cotton programme to EU Regulation 392/2012 is Programme 1 selection with High Heat and Dryness Level Cupboard Dry (the standard/default configuration). This is the most efficient programme in terms of energy consumption (EU 392/2012).

4 Easy Iron Programme

'Easy Iron' is a short 10 minute programme (8 minutes of heat followed by a 2 minute cool tumble period) which fluffs the fibres of clothing that have been left in the same position/location for an extended period of time. The cycle relaxes the fibres and makes them easier to iron and fold.

! 'Easy Iron' is **not a drying programme** and should not be used for wet articles of clothing.

For best results:

1. Do not load more than the maximum capacity.

These numbers refer to the dry weight:

Fabric	Maximum load
Cotton and Cotton mixtures	2.5kg
Synthetics	2kg
Denim	2kg

2. Unload the dryer immediately after the end of the programme, hang, fold or iron the articles and put them away in the closet.

Should this not be possible repeat the programme.

The 'Easy Iron' effect varies from one fabric to the next. It works well on traditional fabrics like Cotton or Cotton mix, and less well on acrylic fibres and on materials such as Tencel®.

Laundry

GB

Sorting laundry

- Check the symbols on the care labels of the various garments to verify whether the garments can be safely tumble dried.
- Sort laundry according to the type of fabric.
- Empty all pockets and check for loose buttons.
- Close zips and hooks and fasten belts and strings without tightening them.
- Wring out garments to remove the maximum amount of water possible.

! Do not load the dryer when garments are dripping wet.

Maximum load sizes

Do not overload the drum.

The following values indicate the weight of dry garments:

Natural fibres: maximum 8 kg

Synthetic fibres: maximum 3 kg

! Do not overload the dryer as this may result in reduced drying performance.

Care labels

Always check the care labels, especially when placing garments in the tumble dryer for the first time. Below are the most commonly used symbols:

- May be tumble dried.
- Do not tumble dry.
- Tumble dry – high heat.
- Tumble dry – low heat.

Drying times

Drying times are approximate and may vary depending on the following:

- Amount of water retained by items after the spin cycle: towels and delicate items retain a lot of water.
- Fabrics: items of the same fabric, but with different texture and thickness may have different drying times.
- Amount of laundry: single items and small loads may take longer to dry.
- Drying: if items are to be ironed, they can be removed from the dryer while still slightly damp. Items that require complete drying can be left longer.
- Heat setting.
- Temperature of the room: the lower the temperature of the room, the longer it will take for the dryer to dry clothing.
- Bulk: certain bulky items require special care during the drying process. We suggest removing these items and replacing them in the dryer once they have been shaken out: repeat this procedure several times during the course of the drying cycle.

! Do not over-dry items.

All fabrics contain natural dampness which helps to keep them soft and fluffy.

The drying times provided refer to the automatic Cupboard dry programmes.

The Timed drying settings are also indicated to enable you to select the most suitable timed option.

The weight refers to dry items.

Cottons							
High Heat - spin speed 800-1000 rpm in washing machine.							
Load size	1 kg	2 kg	3 kg	4 kg	5 kg	6 kg	7-8 kg
Drying times, in minutes	30 - 40	40 - 55	55 - 70	70 - 80	80 - 90	95 - 120	120 - 150
Synthetics							
Low Heat - on reduced spin in washing machine.							
Load size	1 kg			2 kg		3 kg	
Drying times, in minutes	40 - 50			50 - 70		70 - 90	

Note:

At the end of a drying cycle, cottons could still be damp if you grouped cottons and synthetics together. If this is the case, simply give the damp cotton items an additional short period of drying.

One day your dryer seems not to be working. Before you call your Service Centre (see *Service*), go through the following troubleshooting suggestions:

Problem:

The tumble dryer won't start.

Possible causes / Solution:

- The plug is not plugged into the socket, or not making contact.
- There has been a power failure.
- The fuse has blown. Try to plug another appliance into the socket.
- You are using an extension cord? Try to plug the dryer's power cord directly into the socket.
- The door is not closed securely?
- The programme has not been set properly (**see Start and Programmes**).
- The Start/Pause button has not been pressed (**see Start and Programmes**).

Drying cycle will not begin.

- You have set a delayed time (**see Start and Programmes**).

Its taking a long time to dry.

- The filter has not been cleaned (**see Maintenance**).
- The water container needs emptying? The empty water light is flashing? (**see Maintenance**).
- The condenser needs cleaning? (**see Maintenance**).
- The temperature setting is not ideal for the type of fabric you are drying (**see Start and Programmes, and see Laundry**).
- The correct drying time has not been selected for the load (**see Laundry**).
- The air intake grille is obstructed (**see Installation, and see Maintenance**).
- The items were too wet (**see Laundry**).
- The dryer was overloaded (**see Laundry**).

Empty water light is flashing but the dryer has only been running for a short period.

- The water container was probably not emptied at the start of the programme. Do not wait for the empty water signal, always check and empty the container before starting a new drying programme (**see Maintenance**).

Empty water light is on and the water container is not full.

- This is normal, the light flashes when the container is full. If the light is on but not flashing it is just a reminder to empty the container (see Start and Programmes).

The OPTION lights and the START/PAUSE light Flash amber.

- If the Option lights and the START/PAUSE light flash together with other lights on, then:
 - Turn off and remove the plug. Clean the filter and the condenser (see Maintenance). Then replace the plug, turn on and start another programme. If the same combination of lights are on, note down the lights and contact the Service Centre (see Service).

Programme finishes and clothes are damper than expected..

- ! For safety the dryer has a maximum programme time of 5 hours. If an automatic programme has not sensed the required final moisture in this time the dryer will complete the programme and stop. Check the above points and run the programme again, if the results are still damp, contact the Service Centre (see Service).

Note:

This tumble dryer, in compliance with new energy saving regulations, is fitted with an automatic standby system which is enabled after about 30 minutes if no activity is detected. Press and hold the ON-OFF button until the dryer reactivates.

**GB**

Before contacting the Technical Assistance Centre:

- Follow the troubleshooting guide to check whether problems can be solved personally (see *Troubleshooting*).
- If not, switch the dryer off and contact the Technical Assistance Centre closest to you.

Spare parts

This dryer is a complex machine. Attempting to repair it personally or with the aid of an unqualified personnel may put the safety of people at risk, damage the machine or invalidate the spare parts guarantee. Always contact a qualified technician when experiencing problems with this machine.

Product Guarantee And Repair Information

Guarantee

12 Months Parts and Labour Guarantee

Your appliance has the benefit of our manufacturer's guarantee, which covers the cost of breakdown repairs for twelve months from the date of purchase.

This gives you the reassurance that if, within that time, your appliance is proven to be defective because of either workmanship or materials, we will, at our discretion, either repair or replace the appliance at no cost to you:

This guarantee is subject to the following conditions:

- The appliance has been installed and operated correctly and in accordance with our operating and maintenance instructions.
- The appliance is used only on the electricity or gas supply printed on the rating plate.
- The appliance has been used for normal domestic purposes only.
- The appliance has not been altered, serviced, maintained, dismantled, or otherwise interfered with by any person not authorised by us.
- Any repair work must be undertaken by us or our appointed agent.
- Any parts removed during repair work or any appliance that is replaced become our property.
- The appliance is used in the United Kingdom or Republic of Ireland.

The guarantee does not cover:

- Damage resulting from transportation, improper use, neglect or interference or as a result of improper installation.
- Replacement of any consumable item or accessory. These include but are not limited to: plugs, cables, batteries, light bulbs, fluorescent tubes and starters, covers and filters.
- Replacement of any removable parts made of glass or plastic.

THIS GUARANTEE WILL NOT APPLY IF THE APPLIANCE HAS BEEN USED IN COMMERCIAL OR NON-DOMESTIC PREMISES.

Repairs and After Sales

For product help and advice, repairs, spare parts or accessories, we're here to help.

For local repair engineers - **03448 111 606** ROI - **0818 313 413** UK standard local rate applies ROI local Irish rate applies

For Parts and Accessories visit: parts.hotpoint.co.uk/shop

Please remember to register your appliance at www.hotpointservice.co.uk to activate your 10 year parts guarantee.

Please note, our advisors will require the following information: model number, serial number

This information can be found on the data plate located behind the door.

Information on recycling and disposal

As part of our continual commitment towards environmental protection, we reserve the right to use recycled quality components to reduce costs for our customers and to minimise materials wastage.

- Disposing of the packaging materials: follow local regulations to allow for recycling of packaging materials.
- In order to minimise the risk of injury to children, remove the door and plug, then cut the power supply cord flush with the appliance. Dispose of these parts separately to prevent the appliance from being connected to a power supply socket.

Disposal of old household appliances



European Directive 2012/19/EC concerning Waste Electrical and Electronic Equipment (WEEE) states that household appliances should not be disposed of using the normal solid urban waste cycle. Exhausted appliances should be collected separately in order to optimise the cost of re-using and recycling materials comprising the machine, while preventing potential damage to public health and the environment. The crossed-out wheeled bin symbol appears on all products to remind owners of the obligations regarding separate waste collection.

Owners should contact their local authorities or appliance dealers for further information concerning the correct disposal of household appliances.



This appliance has been designed, constructed and distributed in compliance with the requirements of European Directives:

- LVD 2014/35/EU, EMC 2014/30/EU and RoHS 2011/65/EU.