

Zander

habitat

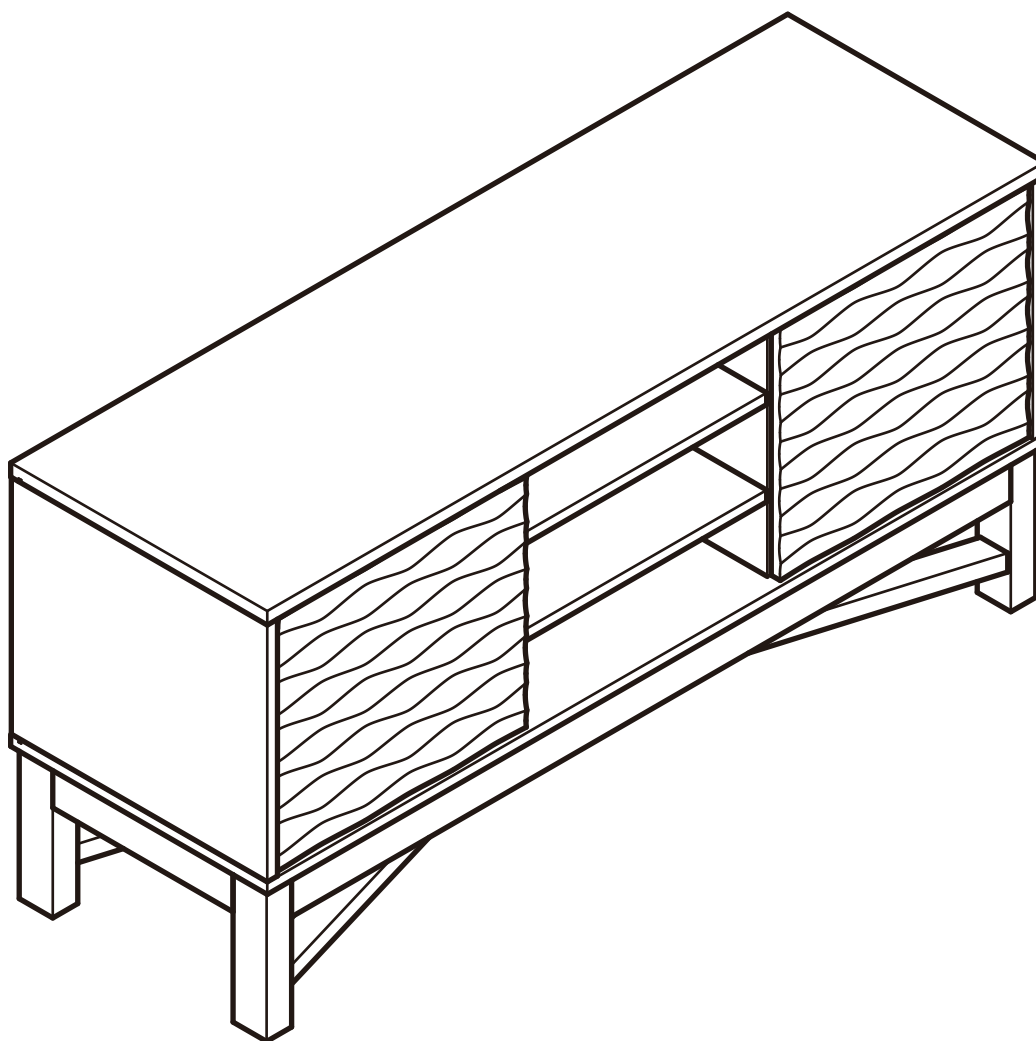

Spare Parts

 www.argos-support.co.uk

 Help@ClickSpares.co.uk

 0370 112 1928

Customer Support

 0345 640 2020



Safety and Care Advice

Product Details

Textured TV Unit
725/4419 White/Oak Effect
525/2640 Grey

IMPORTANT, RETAIN FOR FUTURE REFERENCE: READ CAREFULLY.

- Keep children and animals away from the work area, small parts could choke if swallowed.
- Assemble the item as close to its final position (in the same room) as possible.
- Assemble on a soft level surface to avoid damaging the unit or your floor.
- We do not recommend the use of power drill/drivers for inserting screws as this could damage the unit. Only use hand screwdrivers.
- Parts of the assembly will be easier with 2 people.
- Dispose of all packaging carefully and responsibly.

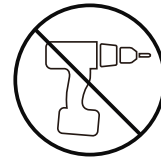

Care and maintenance

- Only clean using a damp cloth and mild detergent. Do not use abrasive cleaners.
- Use a dry cloth to clean the product, furniture polish is not recommended.
- From time to time check that there are no loose screws, nuts or bolts. If there are please re-tighten.
- This product should not be discarded with household waste. Take to your local authority waste disposal centre.

WARNING

In order to prevent overturning this product must be used with the wall attachment device provided.

Additional Guidance

- Assemble all parts and bolts loosely during assembly, only once the product is complete should you fully tighten the bolts.
- Regularly check and ensure that all bolts and fittings are tighten properly.
- This product is compliant BS4875-7 level 3

Fittings (Shown to scale)

Bag 1

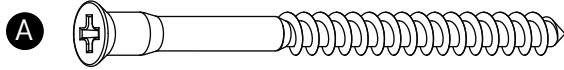

A
5 x 65mm Screw x 10
SCR05065



B
5 x 50mm Screw x 16
SCR05050

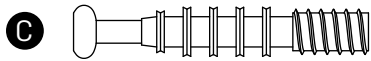

C
7 x 39mm Locking Pin x 20
SCR07039

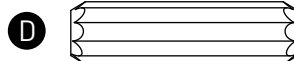

D
8 x 40mm Dowel x 12
PGW0840

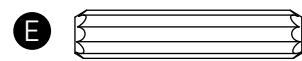

E
6 x 30mm Dowel x 4
PGW0630



F
15 x 12mm Locking Nut x 20
FIT1512000

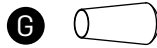

G
Support Cover x 8
PGP0412

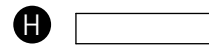

H
4 x 18mm Shelf Support x 8
PGM0418

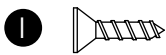

I
3 x 12mm Screw x 6
SCR03012W



J
Leg Pad x 4
FOT0170151

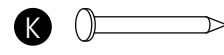

K
1.2 x 20mm Nail x 1
ELSNAIL

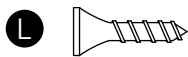

L
3.5 x 15mm Screw x 18
SCR03015



M
Bracket x 6
PARBLK07

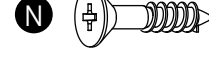

N
3 x 18mm Screw x 6
SCR03018

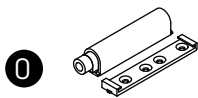

O
Push Open Device x 2
PAR082015175

Hardware

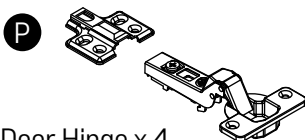

P
Door Hinge x 4
HIG0900048354F

Tools required

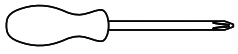

Phillips screwdriver
(small & medium)

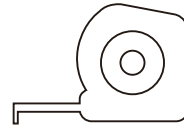

Ruler/tape
measure

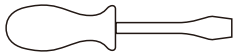

Phillips screwdriver
(small & medium)

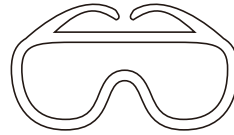

Eye protection
(when using a
hammer or glue)



Small
hammer

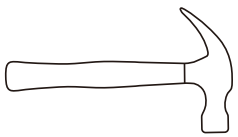

Large hammer

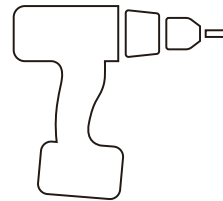

Power Drill



Pencil

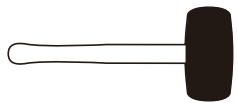

Mallet



Drill Heads

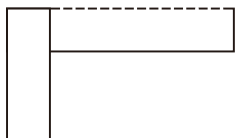

Set Square



Spirit Level

Panels

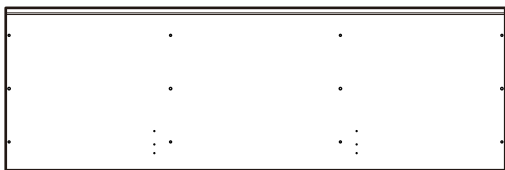

1 Top (1200 x 390mm)

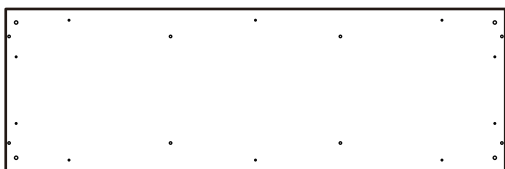

2 Bottom (1200 x 390mm)

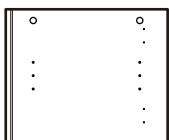

3 Right Side (389 x 319mm)

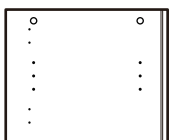

4 Left Side (389 x 319mm)

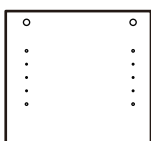

5 Middle Right (349 x 319mm)

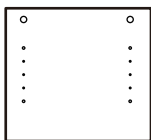

6 Middle Left (349 x 319mm)



7 Middle Shelf (392 x 348mm) (x2)



8 Shelf (372 x 348mm) (x2)

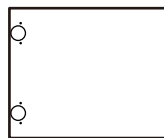

9 Door (312 x 385mm) (x2)



10 Right Front / Left Back Leg (200 x 50mm) (x2)



11 Left Front / Right Back Leg (200 x 50mm) (x2)



12 Side Support (274 x 55mm) (x2)

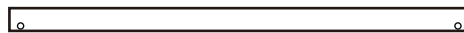

13 Front/Back Support (1112 x 55mm) (x2)



14 Upper Brace (1171 x 40mm)

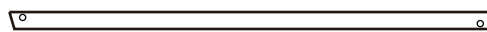

15 Base Brace (1171 x 40mm)

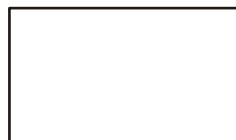

16 Back (540 x 326mm) (x2)

1

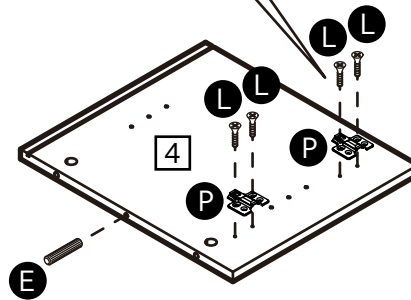
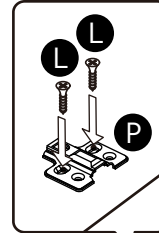
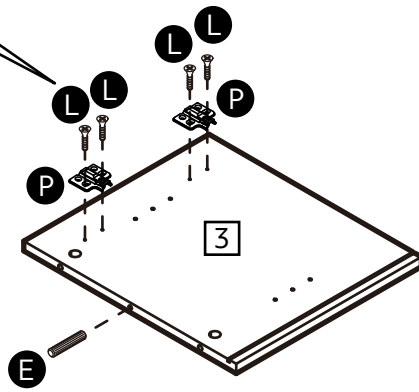
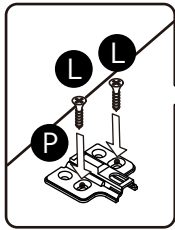
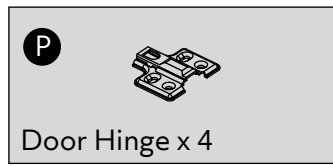
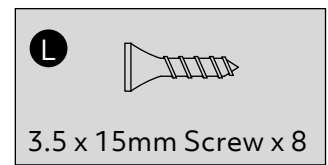
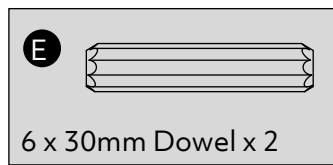
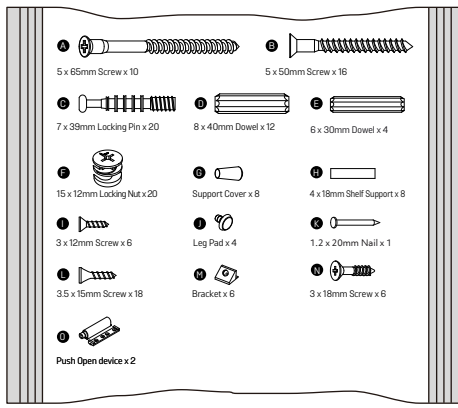

2

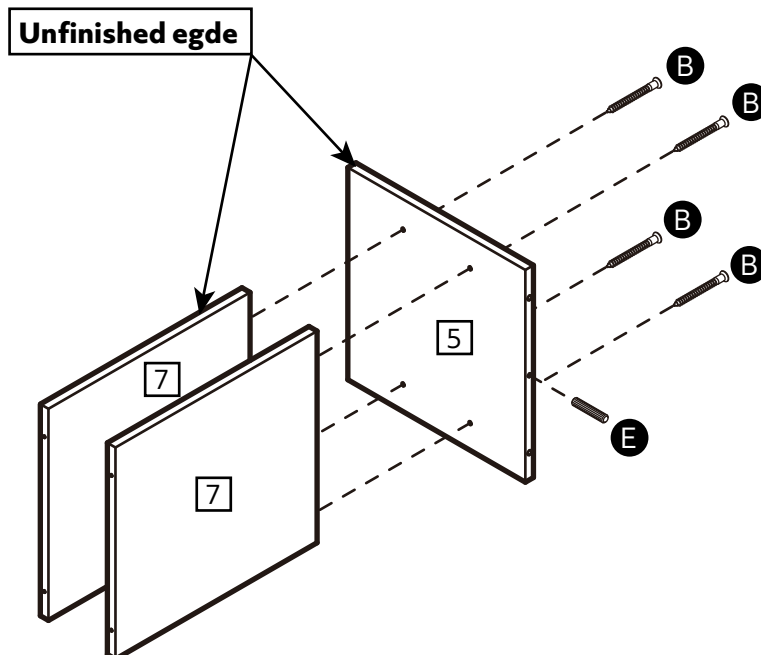
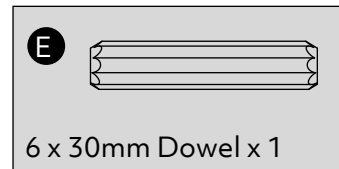
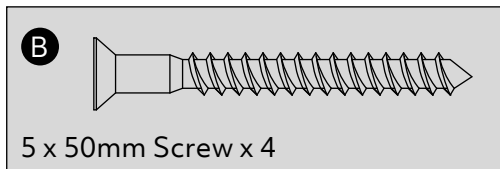

3

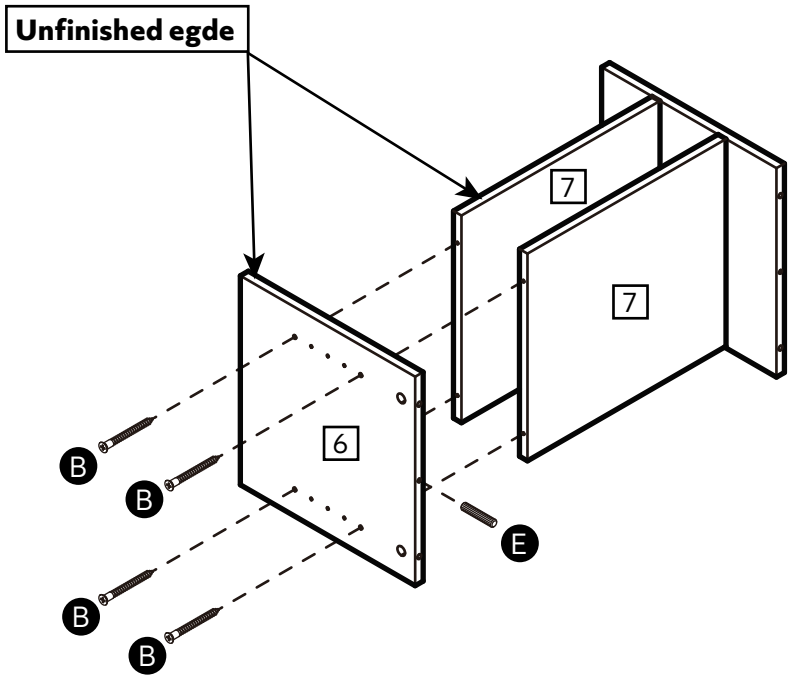
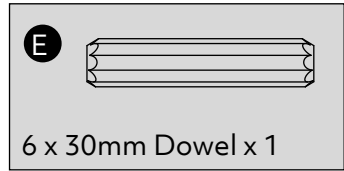
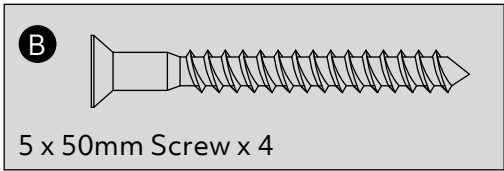

4

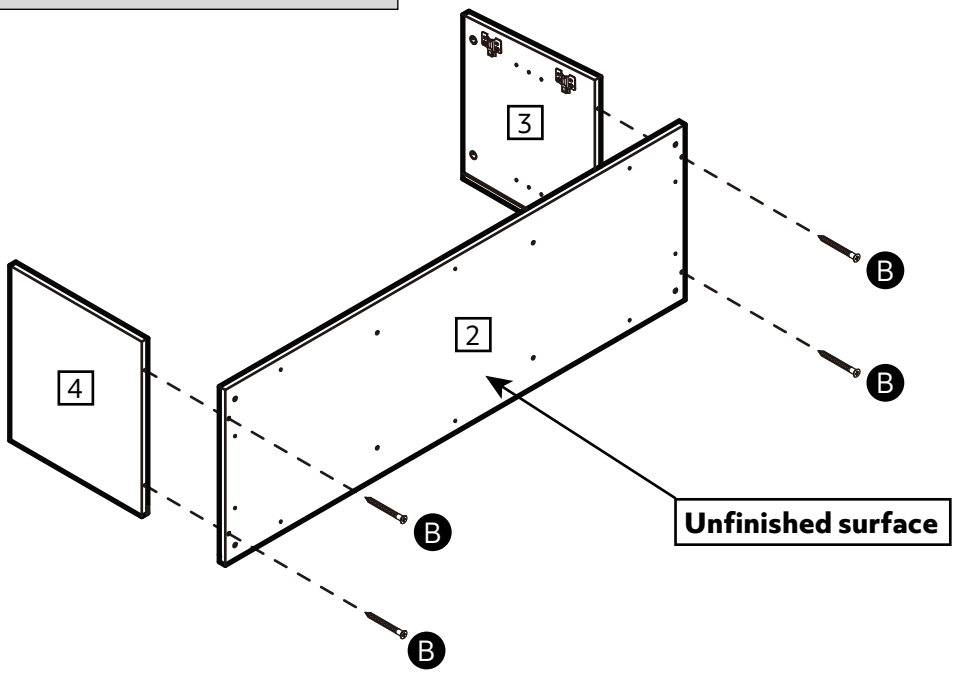
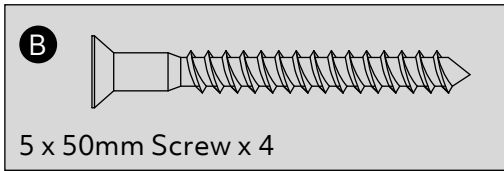

5

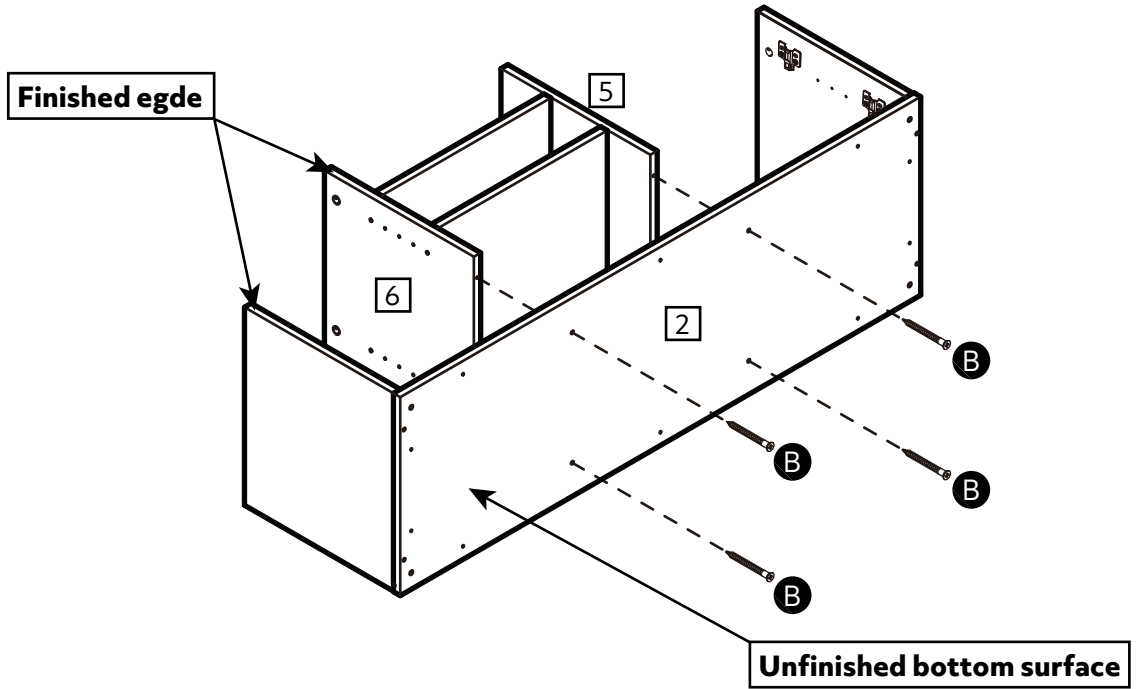
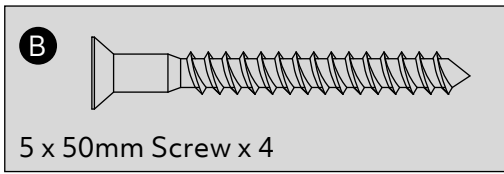

6

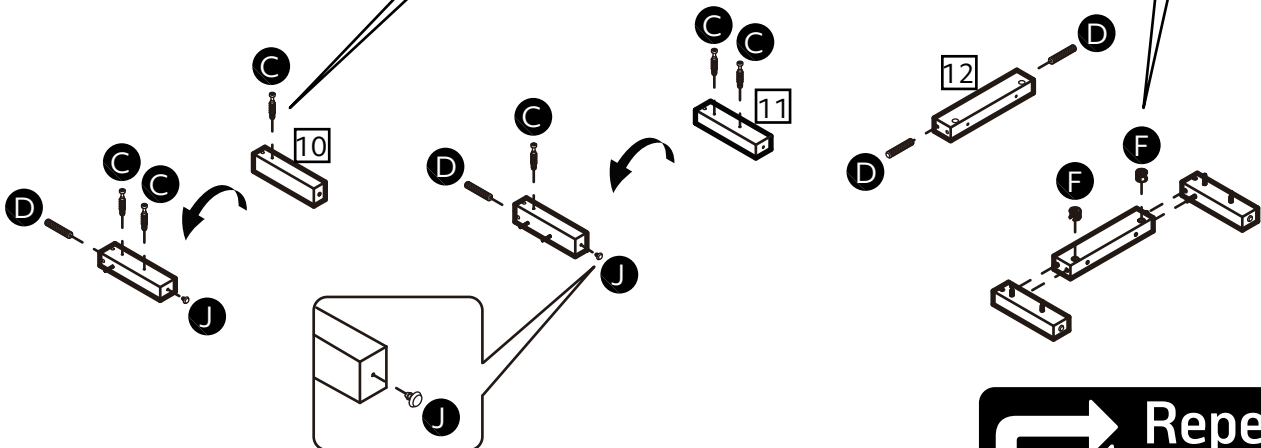
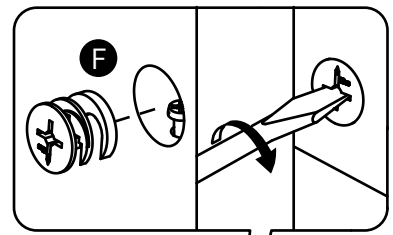
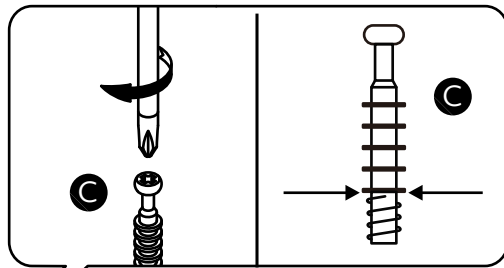
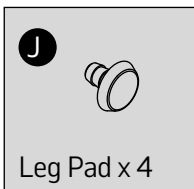
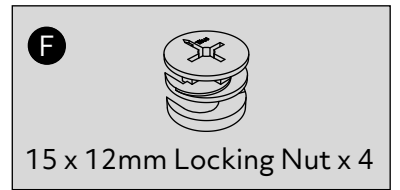
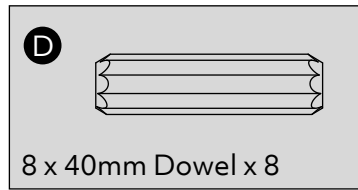
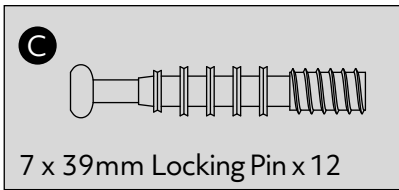

 Repeat
x 2

7

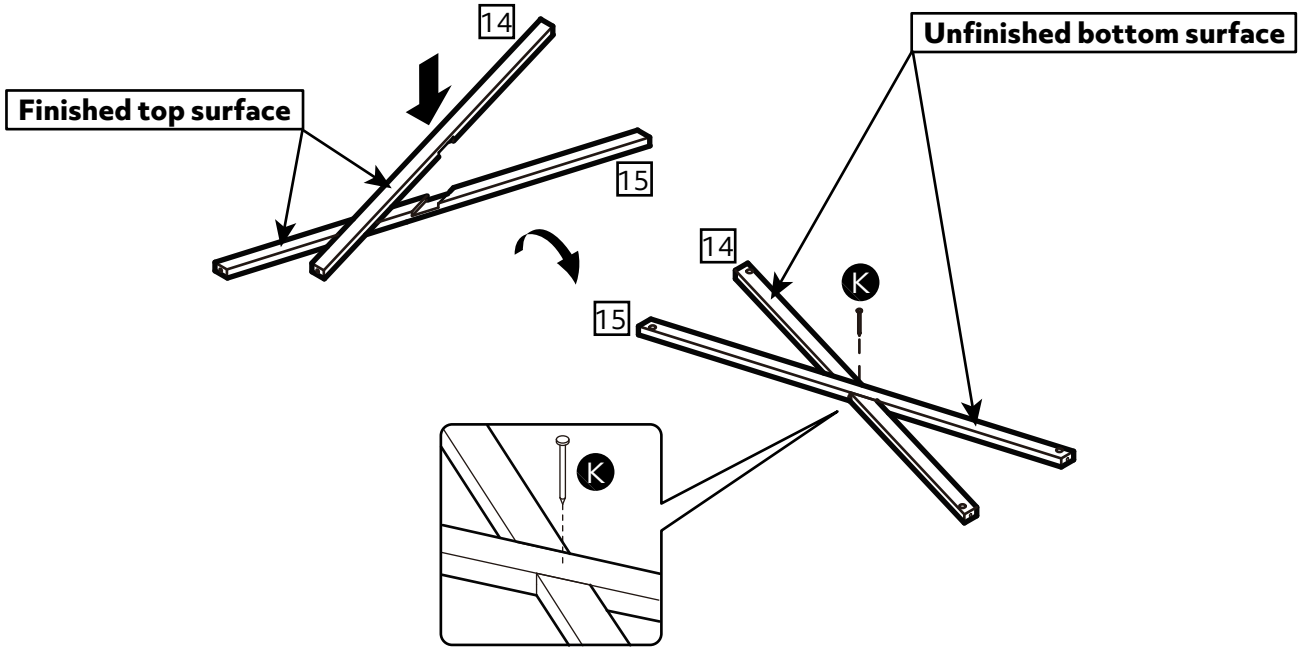
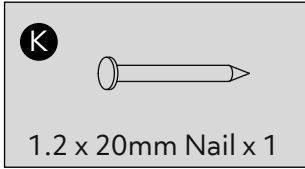

8

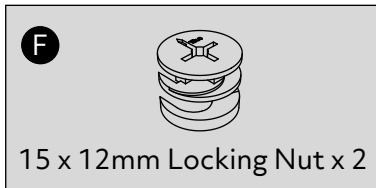
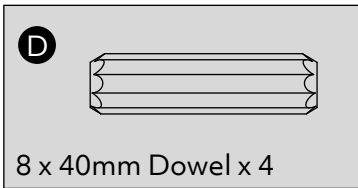

 Repeat
x 2

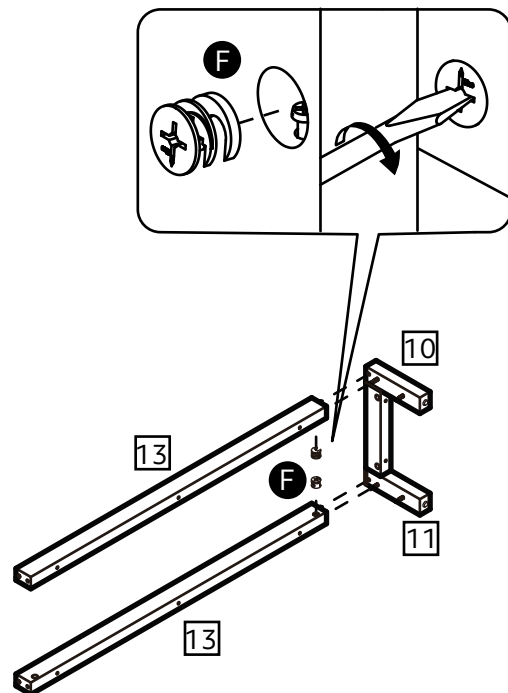
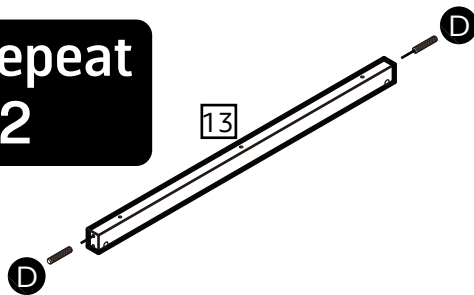

9

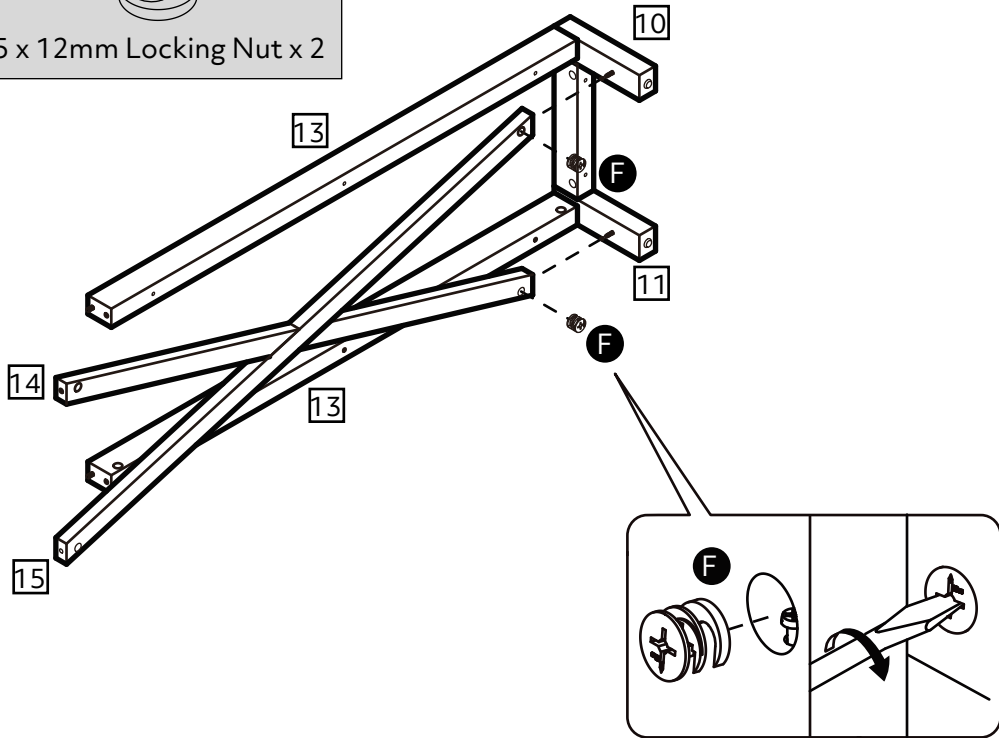
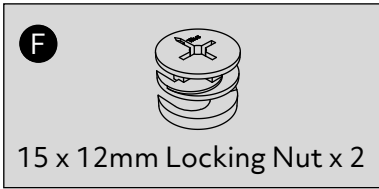

10

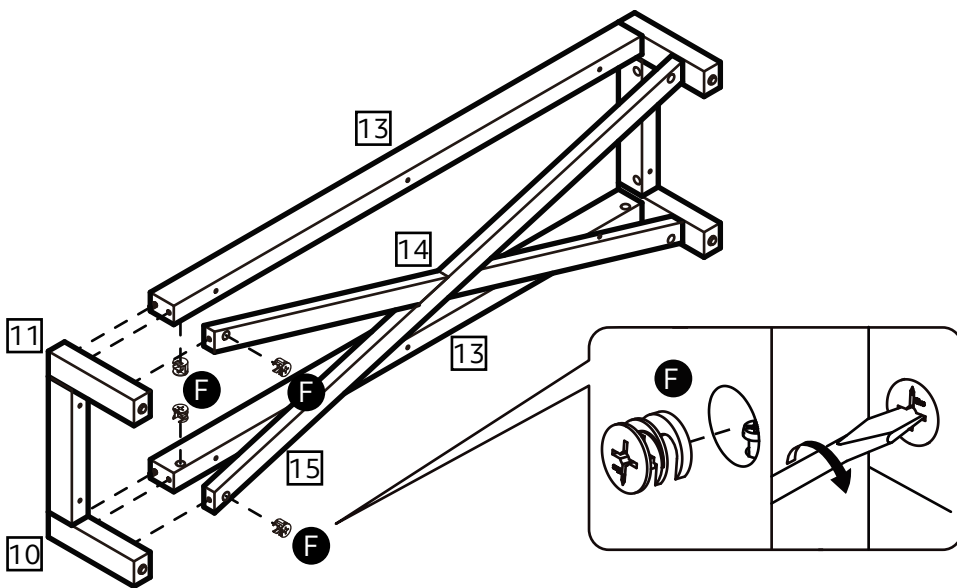
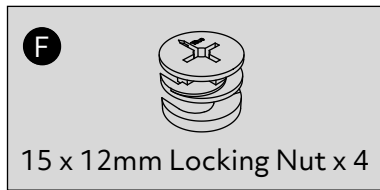

11

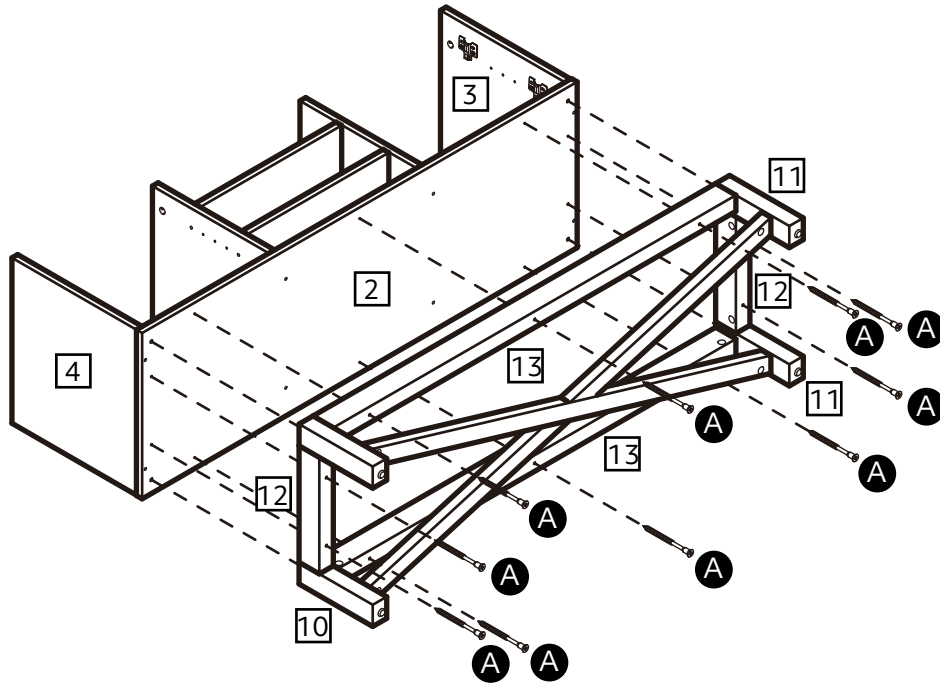
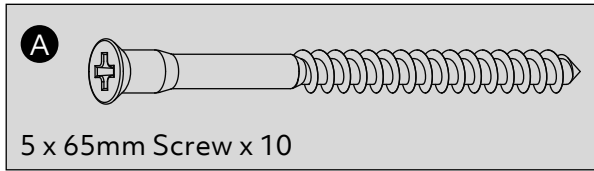

12

Finished front surface

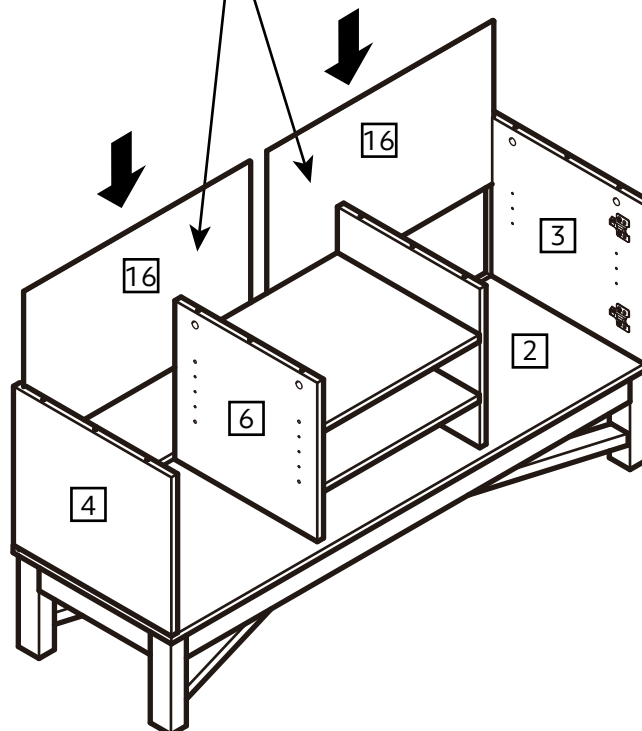

13

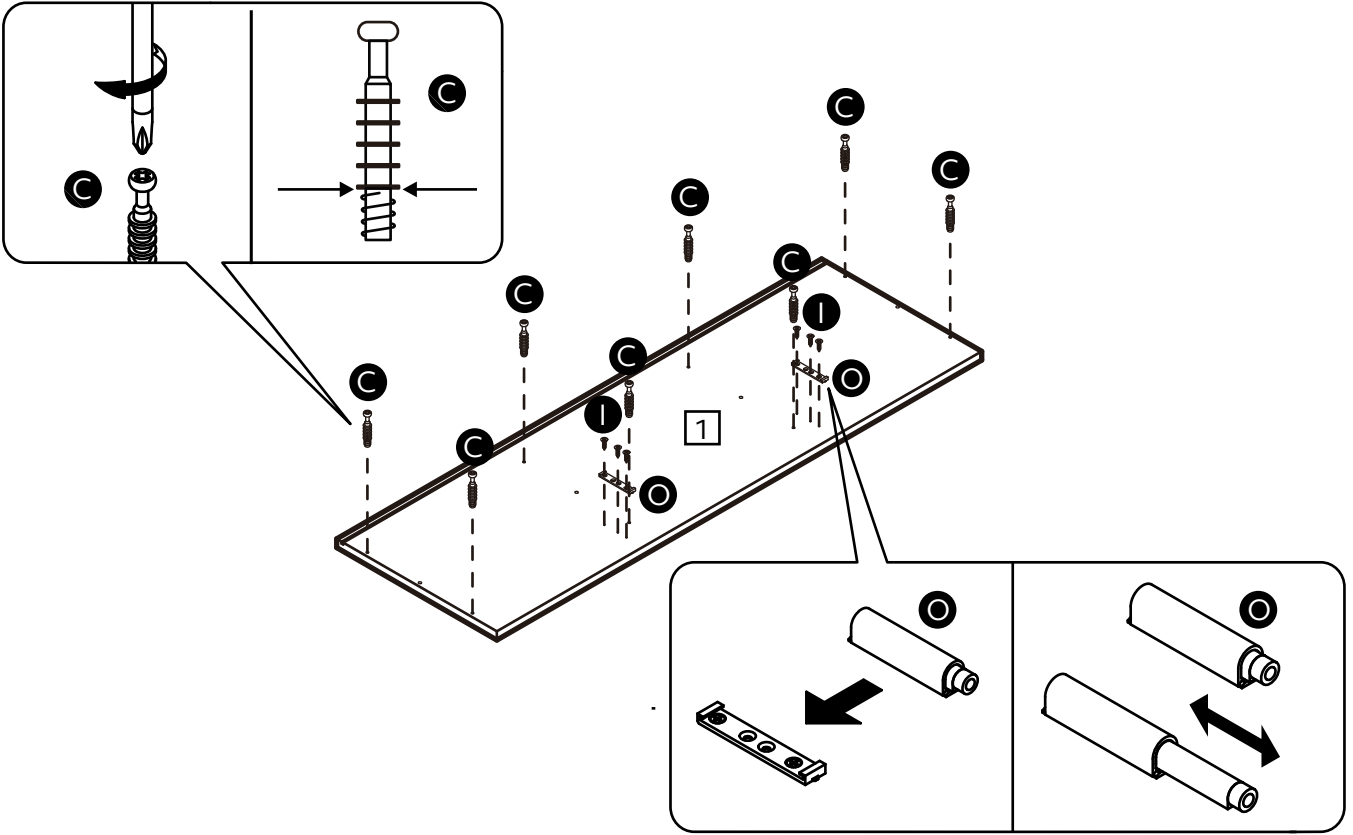
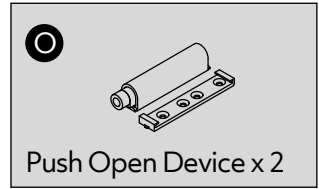
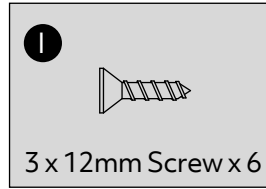
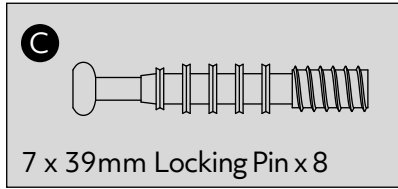

14

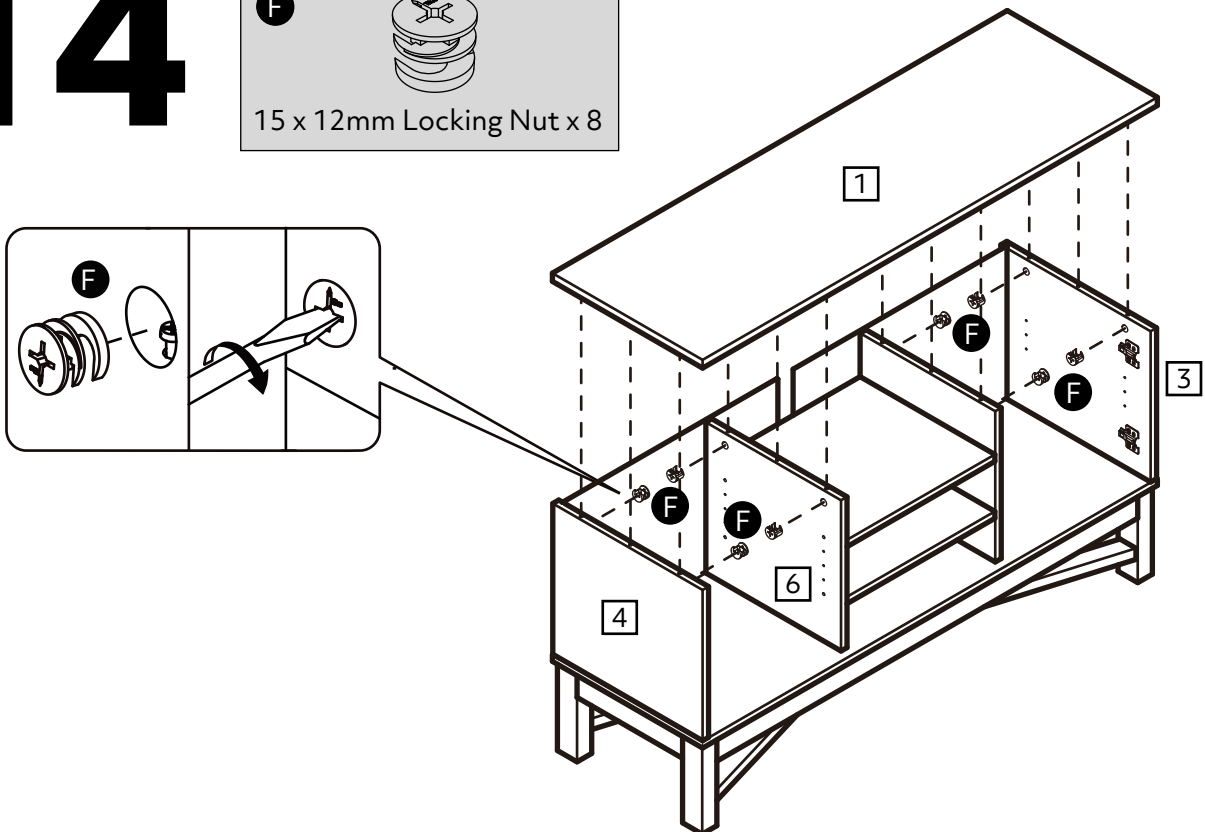
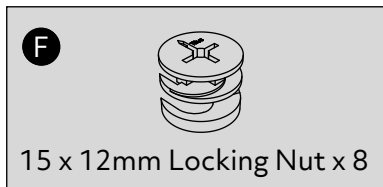

15

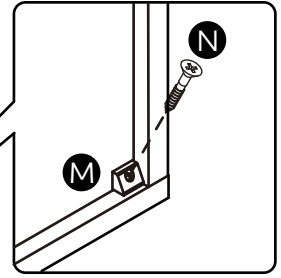
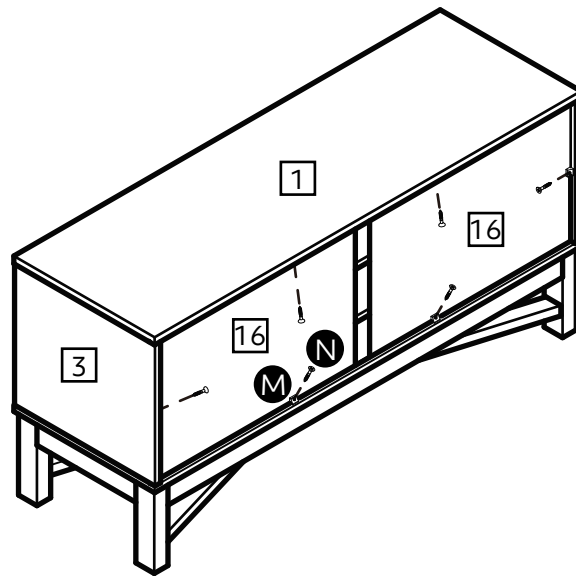
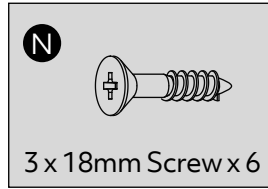
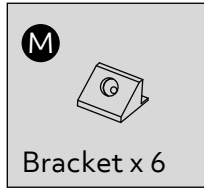

16

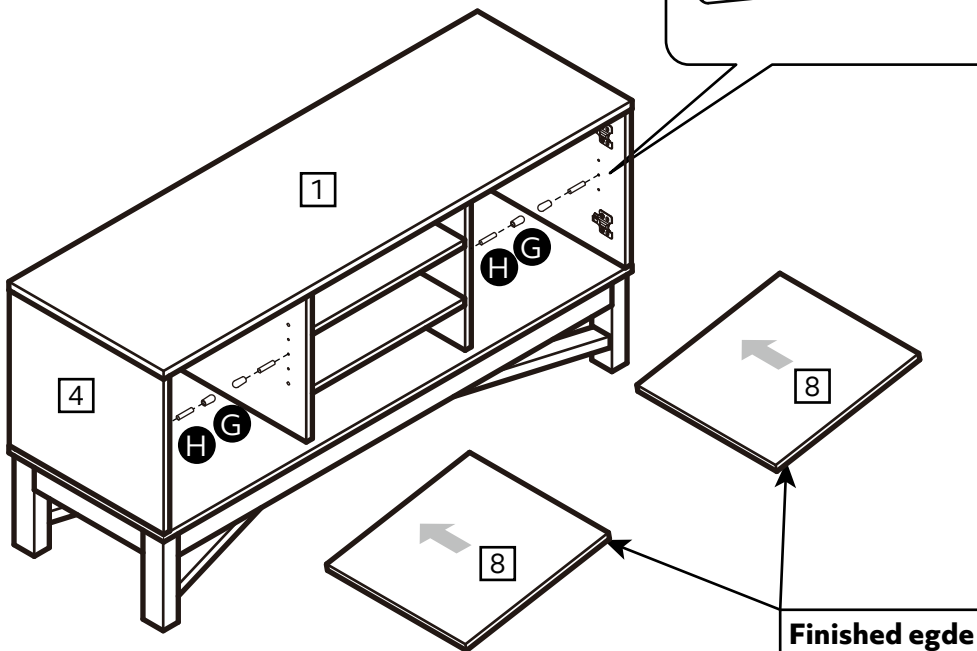
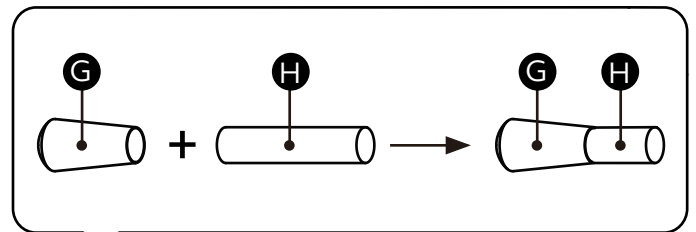
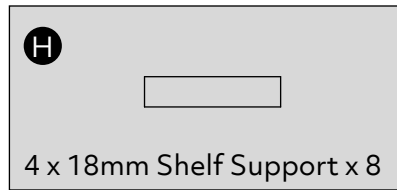
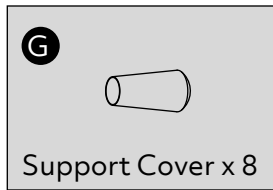

17

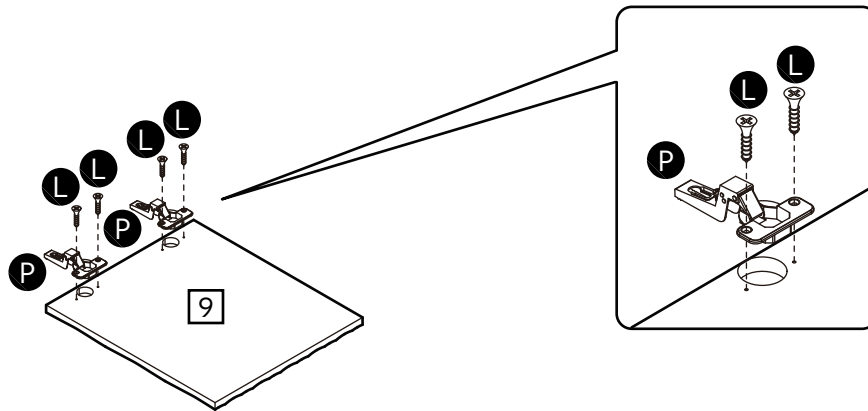
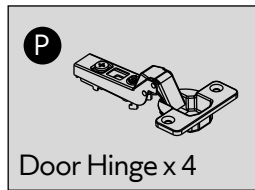
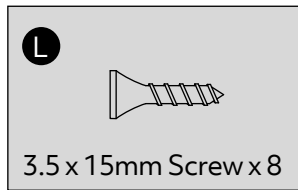

18

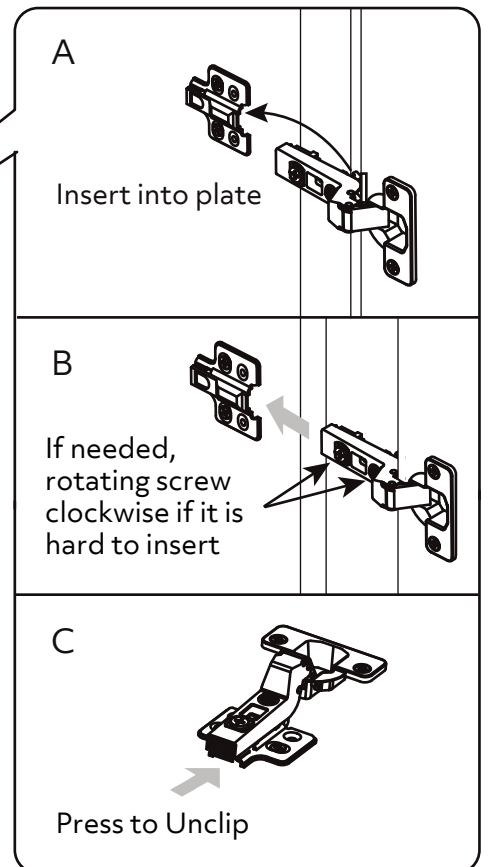
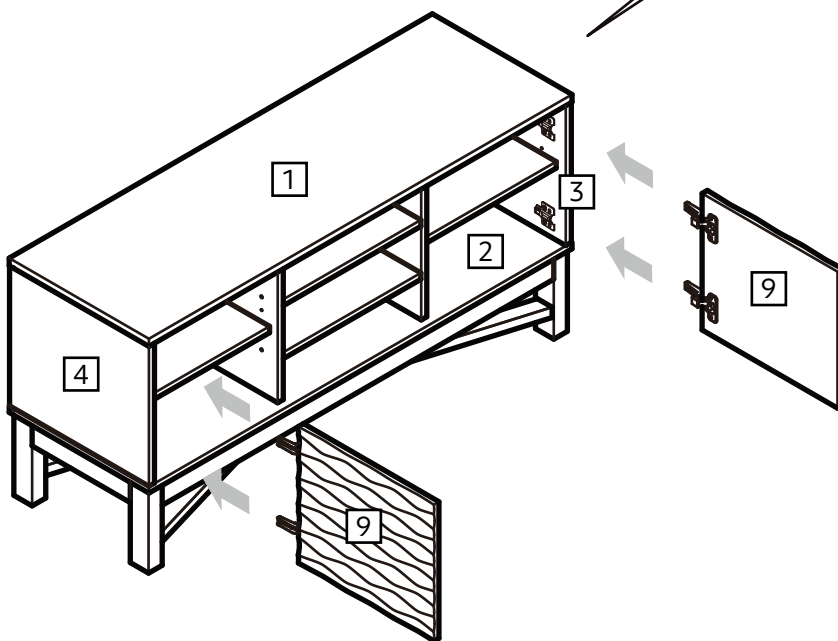

19

Hinges Adjustment

