

Hisense

life reimagined

USER'S OPERATION MANUAL

Before operating this unit, please read this manual thoroughly, and retain for future reference.

Dishwasher

HS622E90WUK

HS622E90BUK

HS622E90XUK

HS622E90GUK

English

Contents

Safety instructions.....	2
Your dishwasher.....	4
Before washing for the first time.....	5
Loading the dishwasher.....	6
Using the dishwasher.....	9
Settings.....	13
Care and cleaning.....	15
Trouble shooting.....	18
Installation.....	23
Service.....	27
Your notes.....	28
Information for test institute.....	29

Safety instructions

General

- Read the operating instructions and keep them in a safe place.
- Never use the dishwasher for any purpose other than that specified in these operating instructions.
- Do not load the dishwasher door or dishwasher baskets with anything other than dishes.
- Use only dishwasher detergent!
- This appliance can be used by children aged from 8 years and above and persons with reduced physical, sensory or mental capabilities or lack of experience and knowledge if they have been given supervision or instruction concerning use of the appliance in a safe way and understand the hazards involved. Children shall not play with the appliance. Cleaning and user maintenance shall not be made by children without supervision.
- This appliance is not intended for use by persons (including children) with reduced physical, sensory or mental capabilities, or lack of experience and knowledge, unless they have been given supervision or instruction concerning use of the appliance by a person responsible for their safety.
- Children should be supervised to ensure that they do not play with the appliance.
- If the supply cord is damaged, it must be replaced by the manufacturer, its service agent or similarly qualified persons in order to avoid a hazard.
- The appliance shall be installed in accordance with national wiring regulations.
- How to fixed the appliance to its support please refer to detail information of installation.
- The door should not be left in the open position since this could present a tripping hazard.
- The openings in the base must not be obstructed by a carpet.
- This appliance is intended to be used in household and similar applications such as:
 - staff kitchen areas in shops, offices and other working environments;
 - farm houses;
 - by clients in hotels, motels and other residential type environments;
 - bed and breakfast type environments.
- Never place dishes with solvent residues in the dishwasher due to the risk of explosion. Nor may dishes that contain ash, wax or lubricants that be washed in the dishwasher.
- Loading the household dishwasher up to the capacity indicated by the manufacturer will contribute to energy and water savings.
- Washing tableware in a household dishwasher usually consumes less energy and water in the use phase than hand dishwashing when the household dishwasher is used according to the manufacturer's instructions.

- Manual pre-rinsing of tableware items leads to increased water and energy consumption and is not recommended.

⚠ WARNING!

Knives and other utensils with sharp points must be loaded in the basket with their points down or placed in a horizontal position.

Installation

See the chapter Installation.

Child safety

Children must be watched. Do not allow children to use or play with the dishwasher. Be especially vigilant when the door is open. Some detergent may remain inside! After adding detergent, always start the dishwasher immediately.

⚠ WARNING!

Children must be supervised- dishwasher detergent is corrosive!

Winter storage/transport

Store the dishwasher above freezing and avoid long transport distances in very cold weather. Transport the dishwasher upright.

Overflow guard function

The overflow protection starts pumping out the machine and turns off the water supply if the water level in the dishwasher exceeds the normal level. If the overflow protection is triggered, turn off the water supply and call the service department.

Packing material

The packaging protects the product during transport. The packaging material is recyclable. Separate the different packaging materials to help reduce raw material use and waste. Your dealer can take the packaging for recycling or direct you to the nearest recycling centre.

Disposal

The dishwasher is manufactured and labelled for recycling.

When the dishwasher has reached the end of its service life and is to be disposed of, it should immediately be made unusable. Pull out the power cable and cut it as short as possible.

Contact your local authority for information about where and how your dishwasher should be correctly recycled.



Your dishwasher

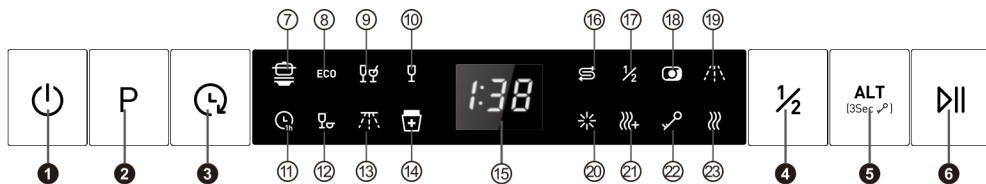

Control button

- ❶ Main power switch
- ❷ Program select button
- ❸ Delay button
- ❹ Half load button
- ❺ Function alternative button/Child lock button
- ❻ Start/Pause button

Function indication

- ❼ Intensive
- ❽ Eco
- ❾ Light
- ❿ Crystal
- ⓫ 60 min
- ⓬ Rapid
- ⓭ Pre-rinse
- ⓮ Self-clean
- ⓯ Display
- ⓰ Salt indicator
- ⓱ Half load indicator
- ⓲ 3 IN 1 indicator
- ⓳ Washing indicator
- ⓴ Rinse aid indicator
- ⓵ Dry+ indicator
- ⓶ Child lock indicator
- ⓷ Drying indicator

Before washing for the first time

Checking water hardness

In order to achieve good dishwashing results, the dishwasher needs soft water (water with low mineral content). Hard water leaves a white coating on dishes and the dishwasher.

Water hardness is specified using the German water hardness scale ($^{\circ}$ dH) or the French water hardness scale ($^{\circ}$ fH). A water supply with a water hardness in excess of 6° dH (9° fH) must be softened. This is done automatically with the aid of the built-in water softener. In order for the water softener to function optimally, it must be adjusted to the hardness of the water supply. Once you have adjusted the water softener, use detergent and rinse aid doses suitable for soft water.

Contact the local waterworks to check the water hardness in your area.

Make a note of the water hardness: _____

If the water hardness exceeds 50° dH (89° fH), we recommend connecting an external water softener.

WARNING!

Hard water leaves a white coating on dishes and inside the dishwasher. It is therefore important that you select the right setting for the water softener! See Water hardness.

Never run the dishwasher with an empty salt compartment if the water supply has a water hardness in excess of 6° dH (9° fH).

Set the water hardness

Chapter Settings describes how to adjust the water softener.

Top up with salt

1. Unscrew the salt compartment lid.



2. Place the funnel supplied with the dishwasher in the salt compartment top-up hole. First, pour in about 1L of water.
3. Then add salt, a maximum of 1.0 kg, until the compartment is full. Use large grain salt or special dishwasher salt.
4. Wipe up any excess salt so that the lid can be screwed on firmly.

In order to avoid rust stains a dishwashing programme must be started immediately after adding salt.

Set the rinse aid

The section Settings describes how to set the rinse aid dosage.

Top up with rinse aid

Drying is faster and a better result is achieved if you use rinse aid. You will also achieve a better dishwashing result with clear and spotless dishes.

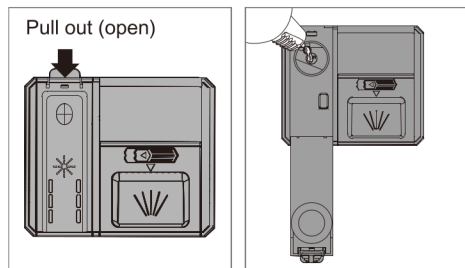

1. Open the rinse aid compartment lid.
2. Carefully top up with rinse aid to the level marked max.
3. Wipe up any splashes of rinse aid around the compartment.
4. Close the lid firmly.

Loading the dishwasher

Greener dishwashing

- Do not rinse under running water. Simply scrape off large food particles before loading the dishwasher.
- Choose an environmentally-friendly detergent. Read the environmental declaration on the packaging!
- Do not start the dishwasher until it is fully loaded to save energy.
- If the dishes are only slightly dirty, you can select a programme with a low temperature.
- Wait until the dishwasher indicates that the programme has ended and the dishes have cooled before unloading the dishwasher. (If the dishwasher is built-in the surrounding furnishings must be resistant to any condensation from the dishwasher.)

Fragile dishes

Some cookware is not dishwasher safe. This can be for several reasons. Some materials cannot withstand strong heat, others can be damaged by dishwashing detergent.

Exercise caution with, for example, handmade items, fragile decoration, crystal/glassware, silver, copper, tin, aluminium, wood and plastic. Look for the "Dishwasher safe" marking.

Points to consider

- All dirty surfaces should face inwards and downwards!
- Dishes should not be placed in or on each other.
- Angle dishes with hollows, such as cups, so that the rinse water will run off. This is also important for plastic items.

- Make sure small items cannot fall through the dishwasher basket; place them in the cutlery basket.

NOTE!

Check that the spray arms can rotate freely.

The dishwasher's baskets

The dishwasher is equipped with an upper basket and a lower basket with a cutlery basket.

The appearance of the baskets may differ depending on the dishwasher setup.

Upper basket

Place glasses, cups, bowls, side plates and saucers in the upper basket. All dirty surfaces should face inwards and downwards!

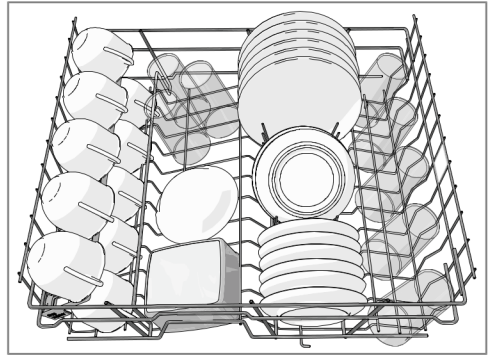

Wine glasses are placed on the wine glass shelf and knives are placed in the knife stand on the right (if fitted).

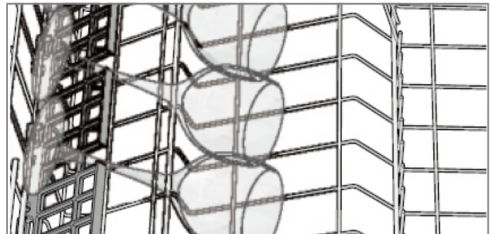

Adjusting the height of the upper basket

NOTE!

Before you adjust its height, make sure the basket is empty.

1. Pull out the upper basket.

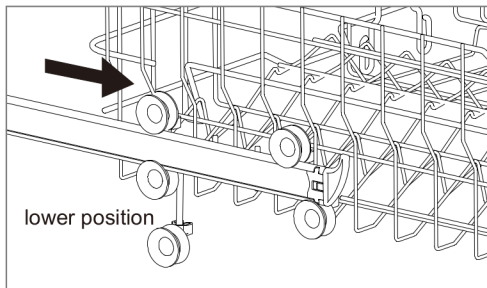

2. Remove the upper basket.

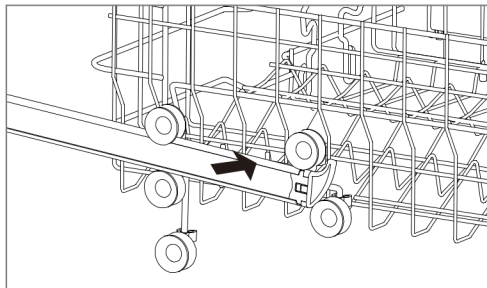

3. Re-attach the upper basket to upper or lower rollers.

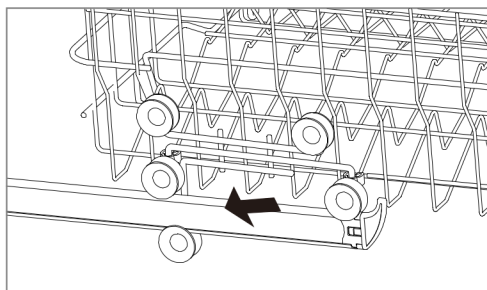

4. Push in the upper basket.

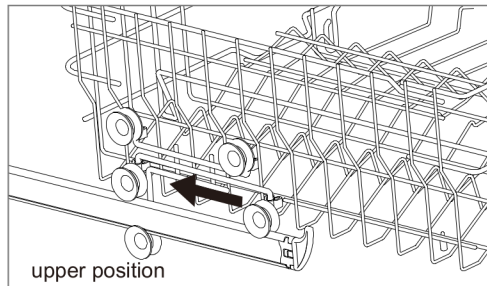

Folding back the cup holders

To make room for taller items in the upper basket, raise the cup rack upwards. You can then lean the taller glasses against it!

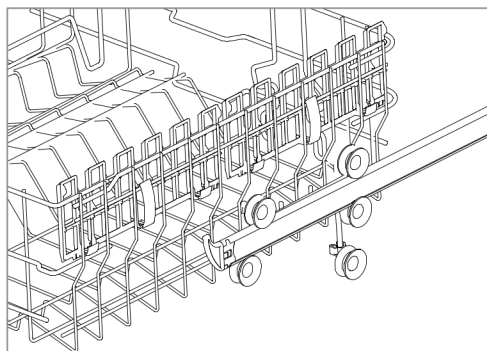
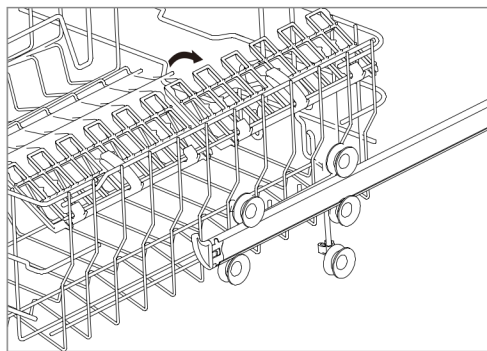

Foldable tines

The foldable tines can be folded up or down to make it easier to load pots, bowls and glasses.

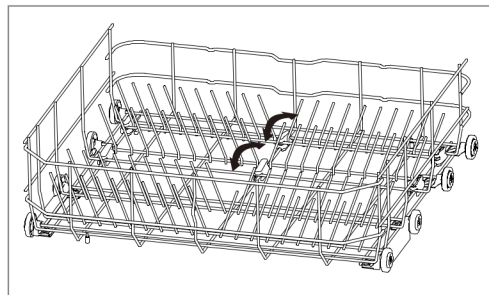

Lower basket

Place plates, side plates, serving dishes, pots and cutlery (in the cutlery basket) in the lower basket.

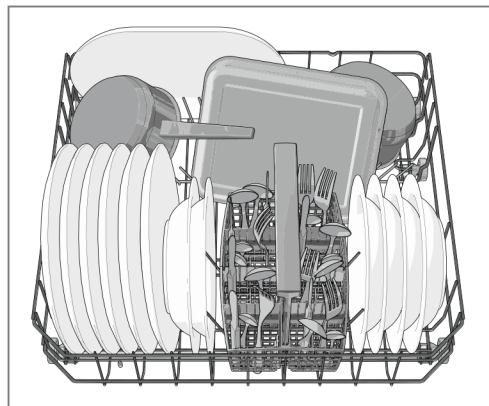

Cutlery basket

The appearance of the cutlery basket may differ depending on the dishwasher setup.

Place cutlery with the handles facing down, except for knives, and spread them out as much as possible. Ensure that spoons do not stack inside each other.

Place the cutlery basket in the lower basket.

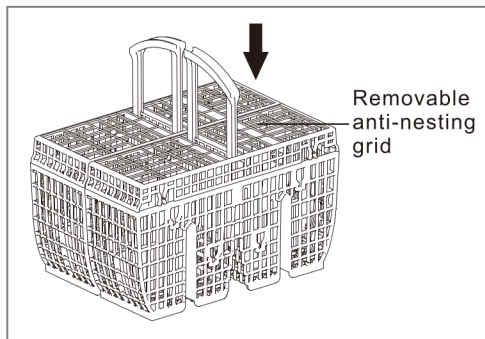

You can halve the cutlery basket as shown and use just one section. This is useful if the cutlery load is light or if you want to make more space for other dishes.

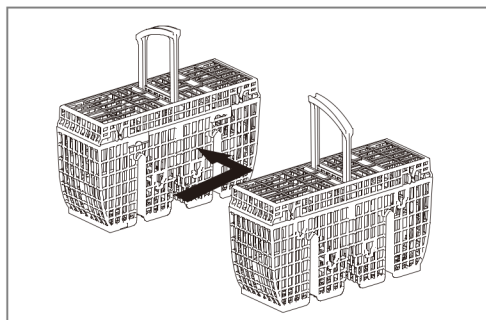

NOTE !

Please place the tableware in proper position according to the manual. False loading shall influence the cleaning result.

Using the dishwasher

Add detergent

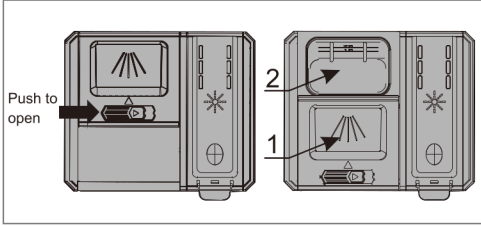

1. Prewash detergent compartment
2. Main wash detergent compartment

Detergent is added according to water hardness.

Follow the instructions on the detergent packaging. This dishwasher is fitted with a water softener, so use detergent and rinse aid doses suitable for soft water.

Too much detergent can result in less effective dishwashing and also entails greater environmental impact.

The detergent compartment must be dry when adding detergent. There is one compartment for the prewash and one for the main wash. If powder or liquid dishwasher detergent is used, add a small amount of the detergent to the prewash compartment. Contact the detergent manufacturer if you have questions about the detergent.

NOTE!

Use only dishwasher detergent! Washing up liquid must not be used as the foam that forms prevents the dishwasher from operating effectively.

Dishwasher tablets

Halve the tablet if it is difficult to close the dispenser lid. There is a risk that the detergent will not be released properly if the lid is tight and will not open correctly.

NOTE!

Dishwasher tablets are not recommended for short programmes (less than 60 minutes). Use powder or liquid dishwasher detergent instead.

All-in-one detergent

There are many types of all-in-one detergents on the market. Read through the directions for these products carefully. Note that salt must be put in the salt compartment. If you are not satisfied with the dishwashing or drying results, top up with salt, detergent and rinse aid. See Chapter Before washing for the first time.

NOTE!

Optimal washing and drying results are achieved by using normal dishwasher detergent together with separately dispensed rinse aid and salt.

The main power switch

Press and hold the main power switch until the display lights up. Also check that the water tap is on.

P Select a programme

Select a programme to suit the type of dishes and how dirty they are.

Press the Programme selector one or more times until the desired programme symbol is activated.

Intensive

Programme for very dirty dishes, such as pans, casserole dishes and oven dishes. Also ideal for situations where demands on hygiene are especially high, such as when dishwashing baby bottles and cutting boards. If these dishes do not completely fill the dishwasher, you can add plates and the like.

ECO Eco wash

This programme is intended for cleaning normally dirty dishes and is the most effective programme in terms of combined energy and water consumption.

Light

Light wash cycle to be used for more delicate items which are sensitive to high temperatures. (Run cycle immediately after use.)

Crystal

This procedure is suitable for washing slightly dirty glass and porcelain tableware.

60 min

For lightly and normally soiled plates and pans for every day.

Rapid

This programme is used for glasses and porcelain that is slightly dirty, such as coffee cups.

Pre-rinse

Used to rinse dishes while you wait for the dishwasher to become fully loaded.

Self-clean

Self-cleaning programme for hygienic cleaning of the dishwasher tub, spray arms and spray pipes.

This programme can be run (with no dishes in the machine) using normal dishwasher detergent or citric acid.

Special dishwasher cleaners are also available on the market. For the removal of limescale deposits, see The dishwasher tub in the chapter Care and cleaning.

EXTRA FUNCTION-Select an option

To select an option, press one of the option buttons until the option is activated. The available options vary between programmes and some options cannot be combined.

Delayed start

When you select Delayed start the dishwasher will start 1-24 hours after you close the door.

1. Press the button once to activate Delayed start. Press the button several times- or hold it in- to set the desired number of hours.
2. Close the door, press start/pause button and the dishwasher counts down 1 hour at a time and starts after the selected delay.

If you want to cancel the Delayed start option, press start/pause button and press and hold the main power switch until the display turns off.

1/2 Half load

This option is suitable for washing a small amount of tableware, using less energy and water.

ALT (3Sec) Function alternative

Press this button, you can choose the additional function "3 IN 1" / "Dry +" / "3 IN 1" and "Dry +", the corresponding light flashes.

3 in 1 indicator

The indicator lights up when the additional function is selected.

Dry+ indicator

The Dry+ indicator lights up when the Dry+ additional function is selected.

Child lock indicator

When the program is running, press the child lock button for 3 seconds. The child lock will be available and corresponding indicator light flashes. Press the child lock button for 3 seconds, child lock function canceled.

Press Start/Pause button

Close the dishwasher door, press the Start/Pause button, the appliance will start or pause the expected washing cycle. Make sure the water tap is on.

Display-Time remaining

Once you have chosen a programme and options, the time the programme took when last used is displayed.

Once you have started the dishwasher, the display shows the remaining programme time. The remaining time is updated after the water for the final rinse has been heated.

This may differ somewhat from time to time depending on the temperature of the water supply, the amount of dishes, the ambient temperature and other factors.

Stopping or changing a programme

If you want to change programme after starting the dishwasher, Press Start/Pause button, open the door then press and hold the main power switch until the display turns off. Add more detergent if the lid of the detergent dispenser has opened. Then press the main power switch, choose a new programme and close the door, press Start/Pause button.

If you want to load more dishes

Press Start/Pause button, open the door. Add the dishes and close the door. Press Start/Pause button. After a while, the dishwasher continues the programme.

If the dishwasher is turned off due to a power failure

If the dishwashing programme was not finished, the interrupted programme continues when power is restored.

Once the programme has finished

Once the programme has finished, "End" appears on the display.

The dishwasher switches off automatically after the programme ends. Shut off the water tap after each use.

How to get the best drying results

- Fully load the dishwasher.
- Angle dishes with hollows, such as cups, so that the rinse water will run off. This is also important for plastic items.
- Top up with rinse aid or increase the rinse aid dosage level.
- Allow the dishes to cool before unloading the dishwasher.

Unloading the dishwasher

Hot porcelain is more fragile. Leave the dishes to cool in the dishwasher before unloading them.

Unload the lower basket first to avoid any water drops from the upper basket falling onto the dishes in the lower basket.

Programme chart

PROGRAM	Detergent Pre/Mian(g)	EXTRA FUNCTION -Options			Number of prewashes	Main wash (°C)	Number of rinses	Last rinse (°C)	Consumption values ¹⁾		
		half load	dry+	3 in 1					Dishwashing time (approx. min)	Energy (approx. kWh)	Water cons. (L)
Intensive wash	10/25	√	√	√	2	60	2	67	180	1.35	15.8
Eco wash ²⁾	--/21	√	√	√	1	45	2	62	225	0.93	11
Light wash	5/20	√	√	√	1	45	2	55	148	0.8	13
Crystal wash	--/20	√	√	√		40	2	50	92	0.53	9.8
60 min wash	--/25	√	√	√		60	2	65	60	0.94	9.8
Rapid wash	--/15	√	√	x		40	2	45	30	0.48	9.4
Pre-rinse wash	--/--	x	x	x		/	1	/	7	0.01	3
Self-clean wash	--/--	x	x	x		60	2	70	82	0.94	10

- 1) Consumption values vary depending on the temperature of the incoming water, room temperature, load size, selected additional functions and more.
- 2) This dishwashing programme is the standard cleaning cycle used to compile the energy labelling information. It is intended for washing normally dirty dishes and is the most effective programme in terms of combined energy and water consumption.
- 3) "√" means could choose this function, "x" means could not choose this function.

Settings

Open the settings menu:

1. First, make sure the machine is turned off. Press and hold the two button **ALT** (3Sec P) and **P** for 3 seconds until the display light up.

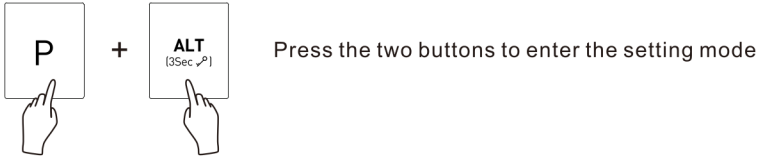

2. The display shows the settings menu (current settings and its currently set value).

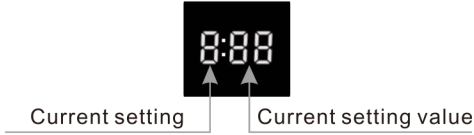

3. Press **ALT** (3Sec P) button, change the currently set value.

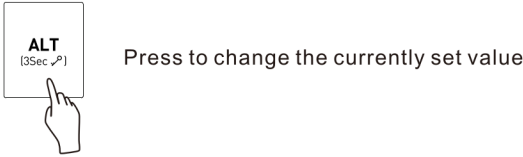

4. Press **P** button, continue the next setting.

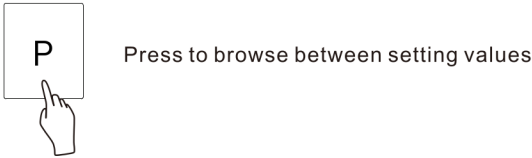

5. Press Start/Pause **▶||** button to save the set value and exit the setting menu.

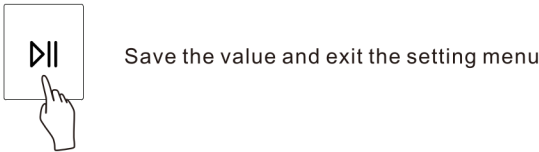

You can now adjust the following settings

Settings		Options																															
1	Water hardness	h00- h07	<p>Adjusting the water softener. Read off the appropriate setting from the water hardness table below.</p> <table border="1"> <thead> <tr> <th>°dH</th> <th>°fH</th> <th></th> <th>°dH</th> <th>°fH</th> <th></th> </tr> </thead> <tbody> <tr> <td>0-5</td> <td>0-9</td> <td>h00</td> <td>20-29</td> <td>35-52</td> <td>h04</td> </tr> <tr> <td>6-8</td> <td>10-14</td> <td>h01</td> <td>30-39</td> <td>53-70</td> <td>h05</td> </tr> <tr> <td>9-11</td> <td>15-20</td> <td>h02</td> <td>40-49</td> <td>71-88</td> <td>h06</td> </tr> <tr> <td>12-19</td> <td>21-34</td> <td>h03</td> <td>50+</td> <td>89+</td> <td>h07</td> </tr> </tbody> </table> <p>Do not forget to put salt in the salt compartment after you have set the water softener to h01-h07. For a water supply with a hardness under 6°dH (9°fH), select h00. The water softener is deactivated and no salt is needed.</p>	°dH	°fH		°dH	°fH		0-5	0-9	h00	20-29	35-52	h04	6-8	10-14	h01	30-39	53-70	h05	9-11	15-20	h02	40-49	71-88	h06	12-19	21-34	h03	50+	89+	h07
°dH	°fH		°dH	°fH																													
0-5	0-9	h00	20-29	35-52	h04																												
6-8	10-14	h01	30-39	53-70	h05																												
9-11	15-20	h02	40-49	71-88	h06																												
12-19	21-34	h03	50+	89+	h07																												
2	Rinse aid	d00- d05	<p>Rinse aid dosage setting.</p> <p>Increase the rinse aid dosage:</p> <ul style="list-style-type: none"> • If the dishes have water marks. <p>Decrease the rinse aid dosage:</p> <ul style="list-style-type: none"> • If the dishes have a sticky white/blue film. • If the dishes are streaked. • Build-up of foam. If you have very soft water, the rinse aid can be diluted 50:50 with water. 																														
3	Buzzer volume	b00- b03	The dishwasher uses a buzzer to indicate when a programme is finished or when a fault has occurred.																														
4	Reset	clr	Press the Start/Pause  button, the machine will be reset.																														

Care and cleaning

☼ Top up with rinse aid

When the rinse aid needs topping up, the above symbol lights on the display.

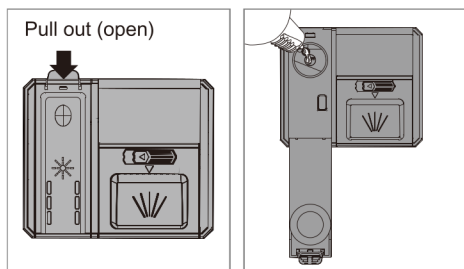

1. Open the rinse aid compartment lid.
2. Carefully top up with rinse aid to the level marked max.
3. Wipe up any splashes of rinse aid around the compartment.
4. Close the lid firmly.

After topping up, it may take a while before the symbol goes out.

⊞ Top up with salt

When the salt needs topping up, the above symbol lights on the display.

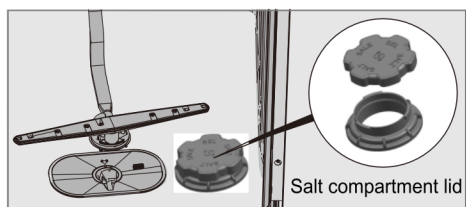

When the salt runs out, unscrew the cap and fill the container with salt. Water is only needed the first time! Wipe clean and tighten. Run a programme to ensure that any salt in the dishwasher is rinsed away.

After topping up, it may take a while before the symbol goes out.

⚠ WARNING!

In order to avoid rust stains a dishwashing programme must be started immediately after adding salt.

Never pour dishwasher detergent into the salt compartment. This destroys the water softener!

Coarse filter

The coarse filter traps larger food particles, which cannot get past the drainage pump. Empty the coarse filter when necessary.

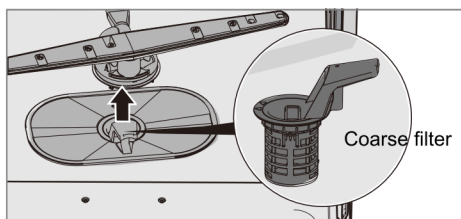

1. Lift the coarse filter by the handle.
2. Empty the coarse filter. Remember to refit it!

Fine filter

Debris that collects on the fine filter is automatically rinsed away during each wash. Clean the fine filter when necessary.

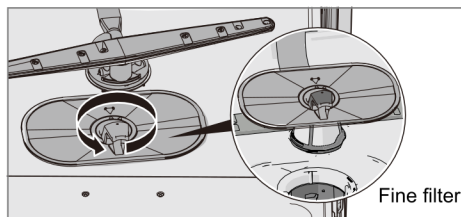

1. Turn the handle anticlockwise.
2. Lift the filter straight up using the handle. Free the coarse filter to clean the fine filter.

- Refit in reverse order. Check that the edges seal properly when refitting the fine filter.
- Lock the filter in place by turning the handle clockwise to the stop position. The handle should point straight out from the dishwasher.

NOTE!

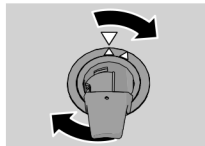

Dishwashing results may be affected if the filters are incorrectly fitted. Note that the dishwasher must not be used without the filters in place!

NOTE!

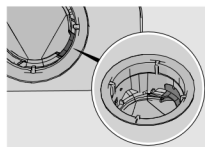

Check that the coloured stop on the right in the bottom drain is in place.

Spray arms

Holes and bearings can sometimes become blocked. Remove any debris using a pin or the like. The spray arms also have holes underneath.

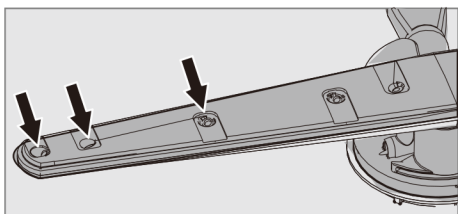

To facilitate cleaning you can remove the spray arms. Remember to fit them firmly back into place afterwards.

Lower spray arm

- Pull the lower spray arm straight up to release it.

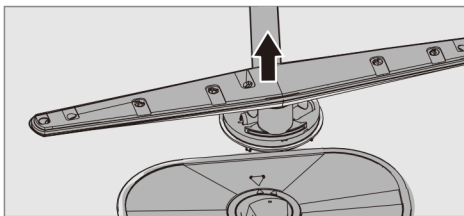

Upper spray arm

- Pull out the upper basket.
- Unscrew the spray arm bearings counterclockwise to remove the spray arm from the upper basket.

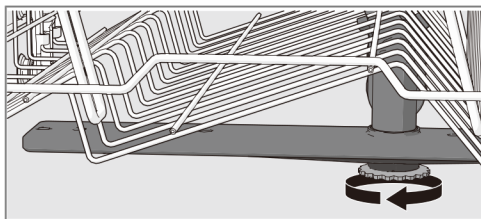

The door and the door seal

Regularly clean the sides of the door and the door seal. Use a slightly damp cloth (with a little cleaner if necessary).

Front panel

Keep the buttons clean and free from grease. Wipe them clean with a dry or slightly damp cloth. Never use cleaners—they can scratch the surface. Use the main power switch to turn off the dishwasher before cleaning the buttons to avoid activating any buttons unintentionally.

The dishwasher tub

The dishwasher tub is made of stainless steel and is kept clean through normal use.

Limescale deposits

If you have hard water, limescale deposits may build up in the dishwasher. If this happens, run a self-cleaning wash programme with two tablespoons of citric acid in the detergent compartment (with no dishes in the machine).

Unblocking the drainage pump

If the dishwasher still contains water after the programme has finished, something may be blocking the drainage pump. Such items are easily removed.

1. Turn off the machine using the main power switch and unplug it from the wall socket.
2. Remove the coarse filter and the fine filter.
3. Scoop out the water from the dishwasher tub.
4. In order to inspect the drainage pump, remove the coloured stop on the right in the bottom drain.
5. Turn the pump wheel located behind the drainage pump stop by hand. Carefully remove any items.
6. Refit the drainage pump stop along with the fine and coarse filters.
7. Plug the machine in again.

If the dishwasher still does not start and a whirring sound is heard, the overflow protection has been activated.

- Shut off the water.
- Remove the plug from the wall socket.

- Call the service department.

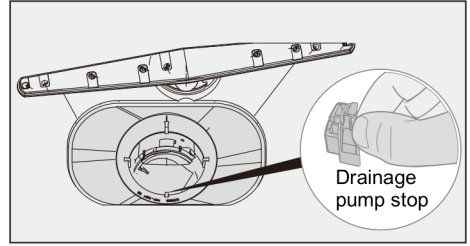

NOTE!

Do not forget to refit the drainage pump stop.

Cleaning the inlet hose filter

If the water supply contains small particles, the outer filter on the inlet hose may become blocked, which results in water inlet fault.

1. Turn off the machine using the main power switch and unplug it from the wall socket.
2. Turn off the water tap.
3. Unscrew the inlet hose.
4. Carefully clean the inlet hose.
5. Screw the inlet hose firmly into place.
6. Plug the machine into the wall socket and turn on the water tap. Allow the pressure to settle for a while and check that the connection is watertight.

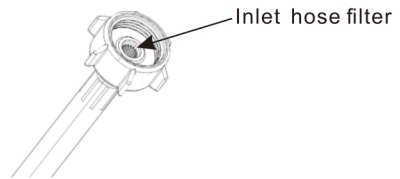

Trouble shooting

Type of the fault on the display		Action
F11	Water outlet fault	See "Water remains in the dishwasher" in the table "Problem" below. If the problem persists, call the service department.
F12	Water inlet fault	Check that the water tap is on. If the problem persists, call the service department.
F13	Water level fault	Turn off the water tap and call the service department.
F40	Inlet valve leakage	Turn off the water tap and call the service department.
F41	Heater fault	Call the service department.
F42	NTC Fault	Call the service department.
F54	Overfilling	Turn off the water tap and call the service department.
F60	Communication Fault	Call the service department.

Press the main power switch to clear the error message.

Problem	Possible causes	Action
The buttons do not react when pressed.	You have pressed the buttons too soon after opening the door.	Wait a moment then try again.
	The buttons are dirty.	Clean with a dry or slightly damp cloth.
Cannot close door.	The baskets are not correctly positioned.	Check that the baskets are correctly positioned horizontally.
		Check that the dishes are not blocking the baskets from sliding properly into place.
Bad odour in dishwasher.	Dirt around the seals and in corners.	Clean with washing-up brush and low foaming cleaner.
	Low temperature programmes have been selected for a prolonged period.	Run a programme with a higher temperature about once a month.

Problem	Possible causes	Action
The dishwasher does not start.	The door is not properly closed.	Check.
	You have opened the dishwasher to add more dishes while a programme is in progress.	Close the door Press Start/ Pause button and wait. After a while, the dishwasher continues the programme.
	A fuse/circuit breaker has been tripped.	Check.
	The plug is not plugged into the wall socket.	Check.
	The water tap is turned off.	Check.
	Overflow/leaks.	Check.
	A whirring sound (the drainage pump) is heard from the dishwasher and does not stop when the main power switch is turned off.	Turn off the water tap. Pull out the plug and call the service department.
	Check that the Delayed start option has not been selected.	Press Start/Pause button, then press and hold the main power switch until the display turns off if you want to cancel the Delayed start option. Restart the dishwasher.
The dishes are not dry enough.	The dishwasher is not fully loaded.	Fully load the dishwasher.
	Rinse aid needs topping up or dosage is set too low.	Top up with rinse add or increase the rinse aid dosage. See the sections Before washing for the first time and Settings.
	3-in-1 detergent is used.	Inactivate 3-in-1 detergent and top up salt and rinse aid.

Problem	Possible causes	Action
The dishes are not clean.	The spray arms do not rotate.	Remove the arms and clean them. Check that the dishes are not blocking the spray arms.
	Spray arm holes or bearings blocked.	Clean the spray arms. See the chapter Care and cleaning.
	Unsuitable dishwashing programme.	Choose a longer programme.
	Incorrect detergent dosage.	Dose according to water hardness. Far too much or far too little detergent results in poorer dishwashing results.
	Old detergent. Detergent is a perishable product.	Avoid large packages.
	Dishes loaded incorrectly.	Do not cover porcelain with large bowls or the like. Avoid placing very tall glasses in the corners of the baskets.
	Glasses and cups have toppled over during the programme.	Place dishes to sit steady.
	The filters are not fitted correctly.	Check that the filter handle is locked in the stop position. The handle should point straight out from the dishwasher.
	Drainage pump stop missing.	Check that the coloured stop on the right in the bottom drain is in place. See the chapter Care and cleaning.

Problem	Possible causes	Action
Spots on stainless steel or silver.	Some foodstuffs, such as mustard, mayonnaise, lemon, vinegar, salt and dressings, can mark stainless steel if left for too long.	Rinse off these types of foodstuffs if not starting the dishwasher immediately. Use the Pre-rinse programme.
	All stainless steel can cause spots on silver if they come into contact during dishwashing. Aluminium can also cause spots on dishes.	In order to avoid marks and tarnishing, separate dishes made from different metals, such as silver, stainless steel and aluminium.
Spots or films on the dishes.	The water softener is leaking salt.	Check that the salt compartment lid is properly tightened. Otherwise call the service department.
	Incorrect water softener setting.	See the chapter Settings.
	Incorrect rinse aid dosage setting.	See the chapter Settings.
	Salt compartment empty.	Top up with salt. See the chapter Before washing for the first time.
	3-in-1 detergent is used.	Inactivate 3-in-1 detergent and top up salt and rinse aid.
	Too high temperature and/or too much detergent can cause etching on crystal. Unfortunately, this cannot be repaired, only prevented.	Wash crystal at a low temperature and with a conservative amount of detergent. Contact the detergent manufacturer.
The dishes have a sticky white/blue film.	Rinse aid dosage setting too high.	Reduce the amount. See the sections Before washing for the first time and Settings. If you have very soft water, you may want to dilute the rinse aid 50:50 with water.

Problem	Possible causes	Action
Spots left after washing.	Lipstick and tea can be difficult to wash off.	Use a detergent with a bleaching agent.
Detergent residue in the detergent compartment after dishwashing.	The detergent compartment was damp when adding detergent.	The detergent compartment must be dry when adding detergent.
Rattling sound when dishwashing.	The dishes are not correctly placed or the spray arms are not rotating.	Check that the dishes are placed securely. Spin the spray arms to make sure they can rotate.
Water remains in the dishwasher.	The filters are blocked.	Clean the coarse and fine filters.
	The filters are not fitted correctly.	Check that the filter handle is locked in the stop position. The handle should point straight out from the dishwasher.
	Debris in the drainage pump.	Clean the drainage pump. See the chapter Care and cleaning.
	Drainage pump stop missing.	Check that the coloured stop on the right in the bottom drain is in place. See the chapter Care and cleaning.
	Kink in drainage hose.	Check that the hose is free from kinks and sharp bends.
	Blocked drainage hose.	Disconnect the drainage hose where it connects to the sink unit's water trap. Check that no debris has fastened and that the connection has an inner diameter of at least 14 mm.

Installation

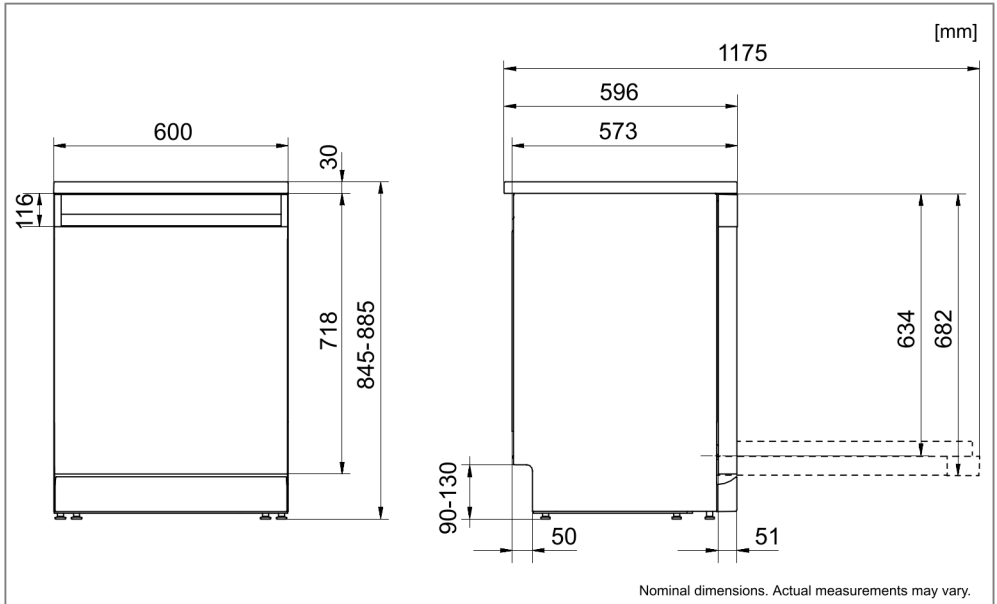

Safety instructions

- Connections to electricity, water and drainage must be performed by a qualified professional.
- Always follow applicable regulations for water, drainage and electricity.
- Take care during installation! Wear protective gloves! There must always be two people!
- Place a drip tray on the floor beneath the dishwasher to prevent damage from any water leaks.
- Before screwing the dishwasher into place, test the dishwasher by running the Rinse programme. Check that the dishwasher fills with water and drains. Check also that none of the connections leak.

WARNING!

Turn off the water supply when installing the dishwasher!

The plug must be disconnected or power to the socket turned off while the work is carried out!

Placing the dishwasher

The dishwasher is intended for freestanding installation, but can also be installed under a cupboard with two ways.

- When the dishwasher is installed with its worktop, the build-in measurements are shown in the illustration.

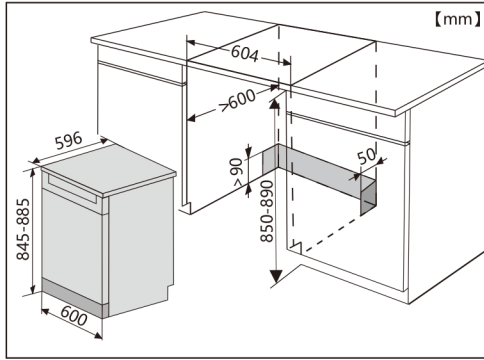

- When the dishwasher is installed in a recess without its worktop, the build-in measurements are shown in the illustration.

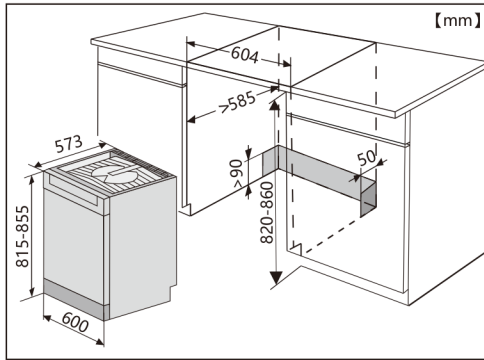

Remove dishwasher worktop

The dishwasher can be installed in a recess without its worktop. If the dishwasher's worktop is removed, the dishwasher must be installed so that it is enclosed on both sides and is under a separate workbench.

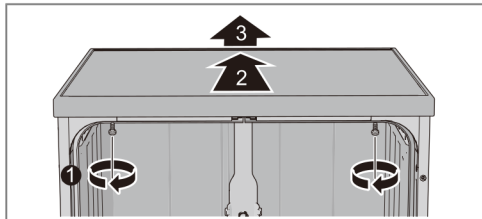

For recess installation, see the section Placing the dishwasher.

⚠ WARNING!

Watch out for sharp edges on the top of side panels.

Adjust the height and slide the dishwasher into place

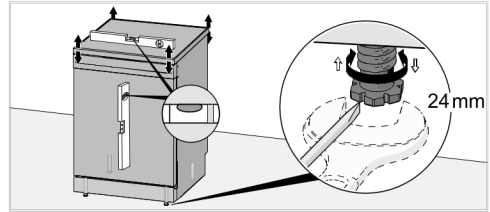

Freestanding

1. Make sure the area on which the dishwasher is to be installed is firm. Adjust the dishwasher's height using the four feet so that the dishwasher is level. The dishwasher may lean no more than 5 mm.
2. Once the feet are properly adjusted, tighten the anti-tip feet firmly against the floor.

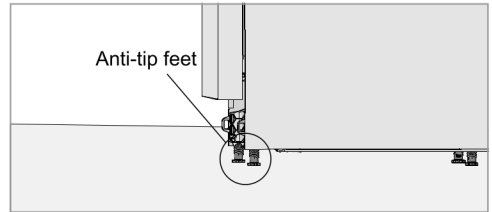

Built-in

1. Start by measuring the height from the floor to the bottom edge of the worktop.
2. Measure the height from the floor to the top edge of the dishwasher.

- Adjust the front feet by turning them clockwise to raise and anticlockwise to lower the dishwasher.

Lean the dishwasher forwards a little and adjust the rear foot with the screw at the front of the dishwasher. Turn clockwise to lower or anticlockwise to raise.

- Check that there is an air gap of at least 3 mm between the underside of the worktop and the top edge of the dishwasher.

- Slide the dishwasher into place.

- Pull through the drainage and supply hoses when the machine is slide into place.
- Check that the hoses have no kinks or sharp bends, and check that there is nothing that can damage the hoses.

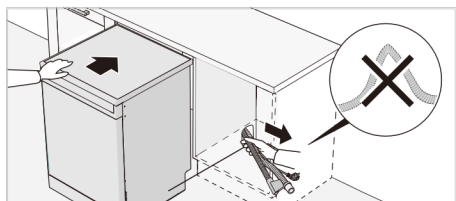

- Check that the machine is installed such that the door opens freely, otherwise door lock functionality may be disrupted.

- Make any final adjustments to the front feet (the dishwasher may lean no more than 5 mm).

- Once the feet are properly adjusted, tighten the anti-tip feet firmly against the floor.

The dishwasher can also be installed in a recess without its worktop. See Remove dishwasher worktop.

Attach the plinth

(Packed inside the dishwasher.)

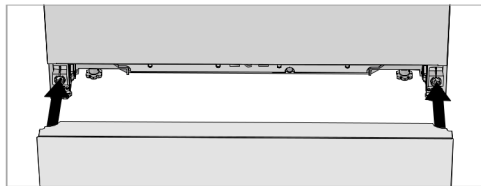

Drainage connection

The drainage hose may be extended by a maximum of 3 m (the total length of the drainage hose must not exceed 4.5 m).

Any joins and connecting pipes must have an internal diameter of at least 14 mm.

However, the drainage hose should ideally be replaced with a new hose without joins.

No part of the drainage hose may be more than 950 mm above the bottom of the dishwasher. The hose must not be routed directly to a floor drain or the like. In such cases, the hose can act as a siphon and empty the dishwasher.

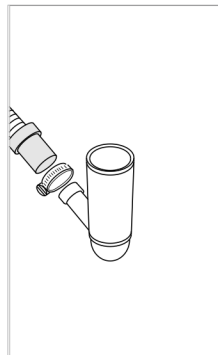
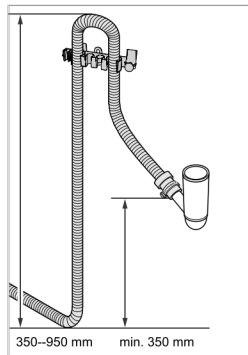
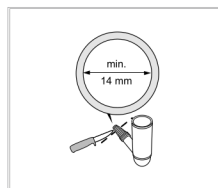
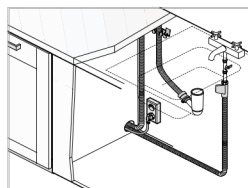

The hose must always discharge at least 350mm above the bottom of the machine. Attach the drainage hose with a hose clamp. Ensure that the drainage hose has no kinks.

NOTE!

When the drainage hose is routed to a connection nipple on the sink unit's water trap, the hose must be attached at the same height as the underside of the sink unit (1), otherwise dishwater from the sink may flow back into the dishwasher. There are other connection alternatives (2, 3). The water trap must be ventilated.

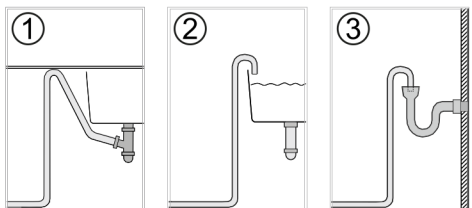

Connection to water supply

Connect the water supply hose to a threaded 3/4(inch).

Use only the inlet hose supplied with the dishwasher. Do not re-use old or other spare hoses.

The supply pipe must be fitted with a water tap (stopcock). The water tap must be easily accessible, so that the water can be shut off if the dishwasher has to be moved.

Once the installation is complete, turn on the water tap and allow the pressure to settle for a while. Check that all connections are watertight.

The water pressure is 0.04-1.0MPa.

Connection to hot water supply

Connect the dishwasher to the hot water supply (max. 60°C) if the building is heated using an energy-efficient means such as district heating, solar power or geothermal power. Choosing a hot water connection reduces the dishwasher's energy consumption.

Connection to cold water supply

Connect the dishwasher to the cold water supply if the building is heated using oil, electricity or gas.

NOTE!

Do not exceed the permitted water supply temperature. Certain materials used in some cookware cannot withstand strong heat. See Fragile dishes in the chapter Loading the dishwasher.

Electrical connection

Information about the electrical connection can be found on the serial number plate.

This specification must match the electricity supply.

The dishwasher must be connected to an earthed socket.

The electric wall socket must be placed outside of the installation area to be easily accessible after installing the dishwasher. Do not use an extension cord!

NOTE!

Change of electrical cables as well as repairs and maintenance relating to safety or performance must be carried out by the manufacturer's service agent or someone with similar professional qualifications.

Service

Read the chapter Troubleshooting before contacting the service department. If you have encountered a problem that you cannot resolve, please contact your nearest dealer. When making contact, provide the details on the serial number plate. Include the article number (1) and the serial number (2).

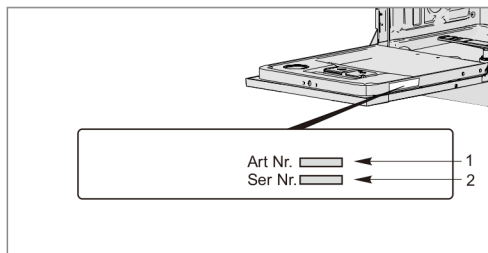

Loading the baskets according to EN60436

1. Upper baskets:

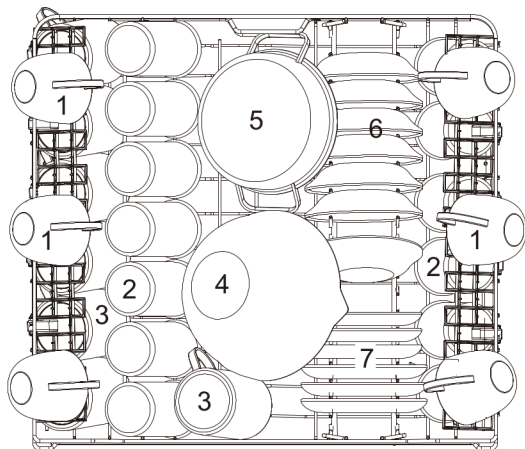

Number	Item
1	Cup
2	Glass
3	Mug
4	Glass bowl
5	Oven pot
6	Dessert bowl
7	Saucer

2. Lower baskets:

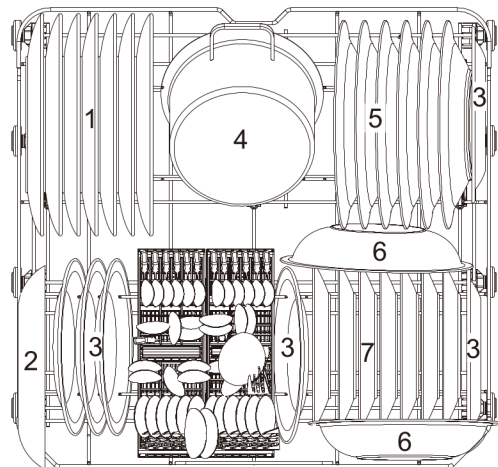

Number	Item
1	Dinner plate
2	Oval platter
3	Melamine dessert plate
4	Small pot
5	Soup plate
6	Melamine bowl
7	Dessert plate

3. Cutlery baskets:

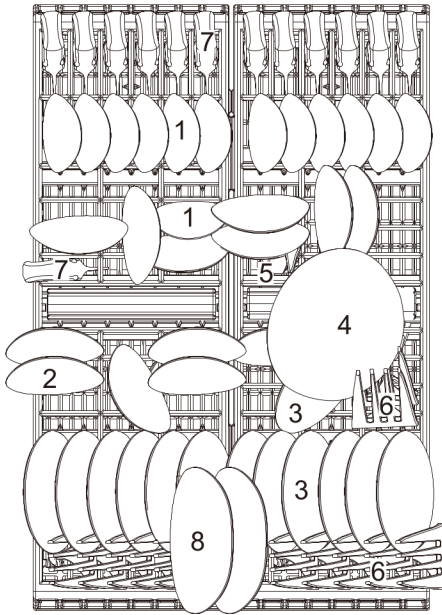

7	7	7	7	7	7	7	7	7	7	7	7
1	1	1	1	1	1	1	1	1	1	1	1
2				1		2		2	2		
7				2		2					
						5					
2				2				6		4	
2				2		2		3		6	
										6	
3	3	3	3	3	3	3	3	3	3	3	3
6	6	6	6	6	8	8	6	6	6	6	6

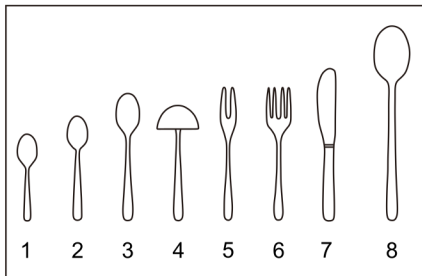

Number	Item
1	Tea spoons
2	Dessert spoons
3	Soup spoons
4	Gravy ladle
5	Serving fork
6	Forks
7	Knives
8	Serving spoon

Information for comparability tests in accordance with EN60436

Capacity: 13 place settings

Position of the upper basket: lower position

Program: Eco

Rinse aid setting: d05

Powdered detergent quantities: 21g main wash

Hisense