

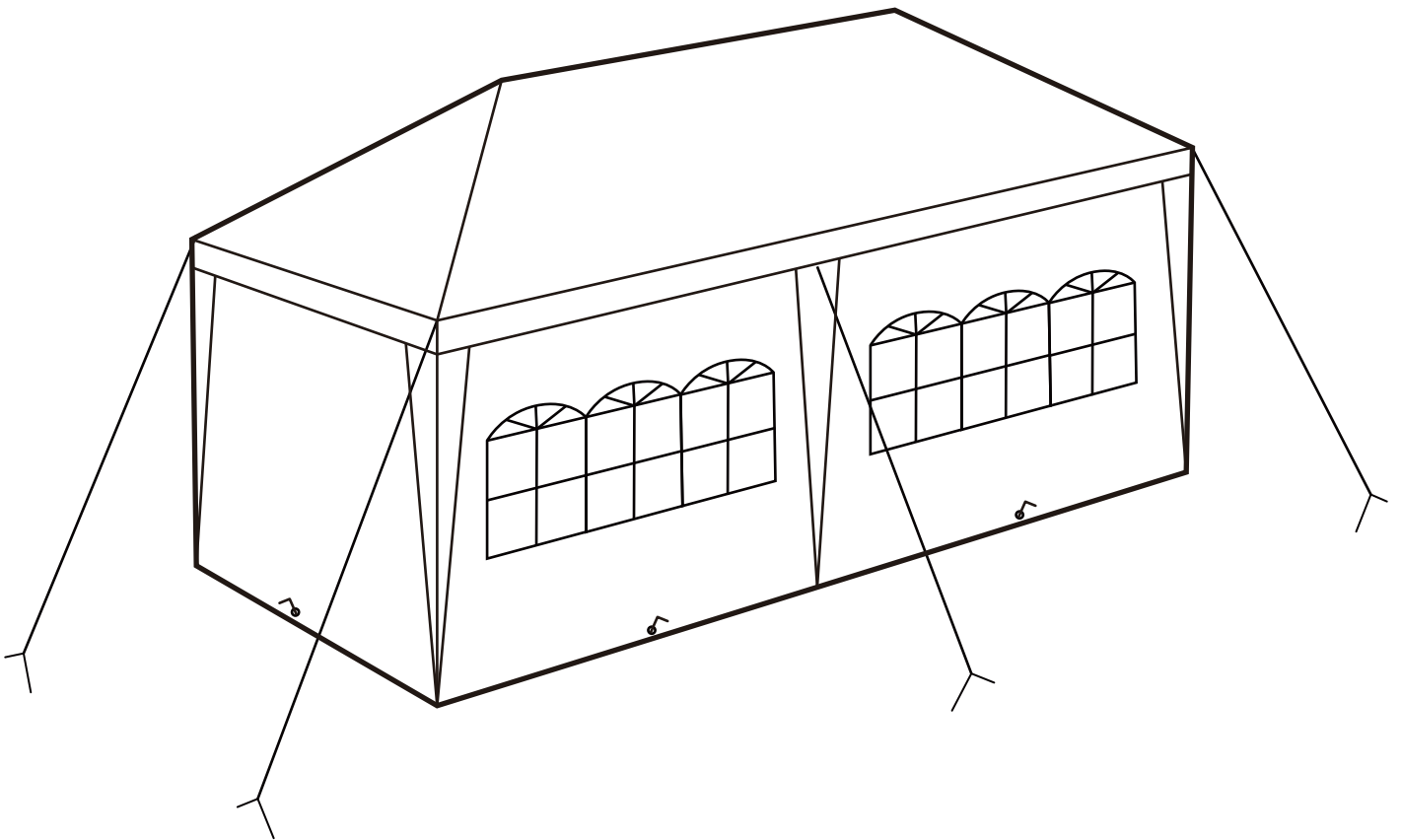

3M X 6M GAZEBO W SIDE PANELS



Spare Parts

 www.argos-support.co.uk

 Help@ClickSpares.co.uk

 0370 112 1928

Customer Support

 0345 640 2020



Safety and Care Advice

Product Details

White/Green 474/0270

IMPORTANT, RETAIN FOR FUTURE REFERENCE: READ CAREFULLY.

- Check you have all the components, fittings and tools listed in this manual.
- Remove all fittings from the plastic bags and separate them into their groups.
- Keep children and animals away from the work area, small parts could choke if swallowed.
- Make sure you have enough space to layout the parts before starting.
- **Do not Assemble or Dismantle during strong winds.**
- This unit is not a permanent fixture - Do not use or leave erected in windy conditions.
- Follow all safety and fire precautions when in or near this gazebo.
- Please do not use the gazebo under windy condition.
- Practice assembling and dismantling the gazebo before use to familiarise yourself with the components and fittings.
- Take note of all the components and fittings and ensure you don't forget anything when dismantling.
- Before each use check you have all the components and fittings and that none of them are damaged.
- We recommend this gazebo assembled by 2-4 persons.
- Ensure the ground is level free from debris and sharp objects that could damage the fabric. Avoid pitching under trees but make use of any nature wind breaks such as hedge rows etc. **Heavy winds and rain could damage the gazebo.**
- Try to locate the gazebo at least 5-10 meters away from any other campers where possible.
- This unit weights approximately 17.5kgs. **Please lift with care.**

Care and maintenance

- Take care when dismantling the gazebo. Follow the assembly instructions in the reverse order and do not force the frame.
- Never remove the pegs by pulling on the guy ropes, fabric or gazebo legs.
- Ensure all parts of the gazebo are completely dry before repacking.
If necessary unpack the parts when you return home and allow to dry completely before repacking and storing.
- All parts should be cleaned and packed separately. When completely dry gently remove any dirt and debris from the fabric with a soft brush.
- Never use abrasive cleaners or detergents.

Additional Guidance

- The canopy and sides of this gazebo are not fire proof, follow the fire precautions and safety at all the times.
- Do not use naked flames in or around the gazebo - there is no cooking area within the gazebo.
- Do not store cooking apparatus, BBQs etc within the gazebo as it may cause a fire hazard.
- Do not smoke or allow smoking in or around the gazebo.

Fittings (Shown to scale)

Bag 1

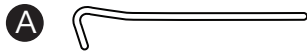

A
Metal Pegs x 18
(\varnothing 4.0x 200 mm)

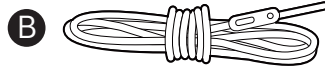

B
Guy Rope x 6

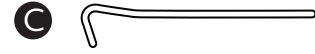

C
Metal Pegs x 6
(\varnothing 5.0x 280 mm)

Components



1 Top Pole (x22)
(Φ24x 1060mm)

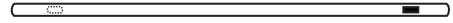

1A Top Pole (x8)
(Φ24 x 1070mm)



2 Support Pole (x7)
(Φ24x 830mm)



3 Leg Pole (x6)
(Φ31x 980mm)



4 Leg Pole (x6)
(Φ31x 1030mm)

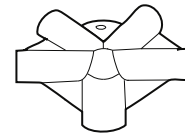

5 Centre Connector (x2)
(135x 100mm)

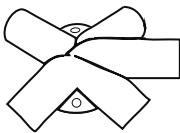

6 Middle Joint (x2)
(130x 100mm)

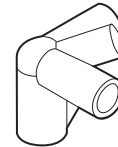

7 Corner Joint (x4)
(85 x 100mm)

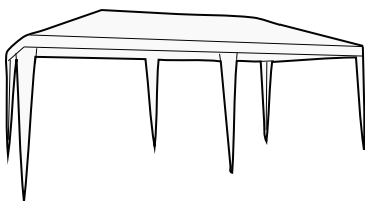

8 Gazebo Cover
(3000 x 6000mm)

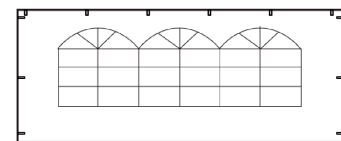

9 Side Panel w/window (x4)
(2900 x 1950mm)

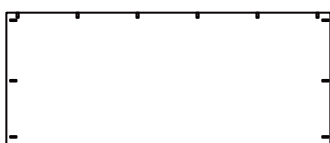

10 Side Panel w/o window (x2)
(2900 x 1950mm)

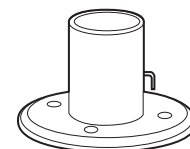

11 Baseplate (x6)
(74x 37mm)

1

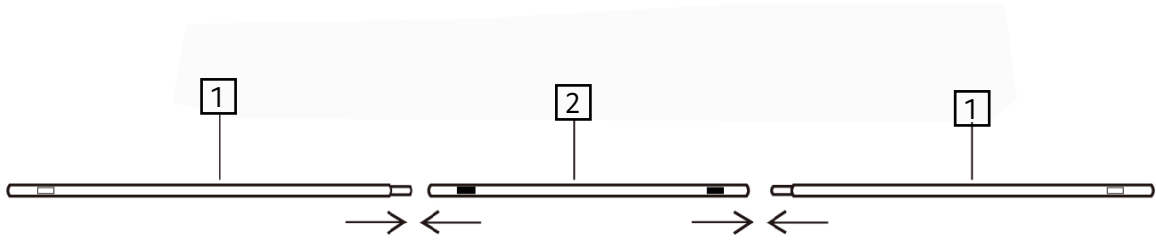

 Repeat
x6

2

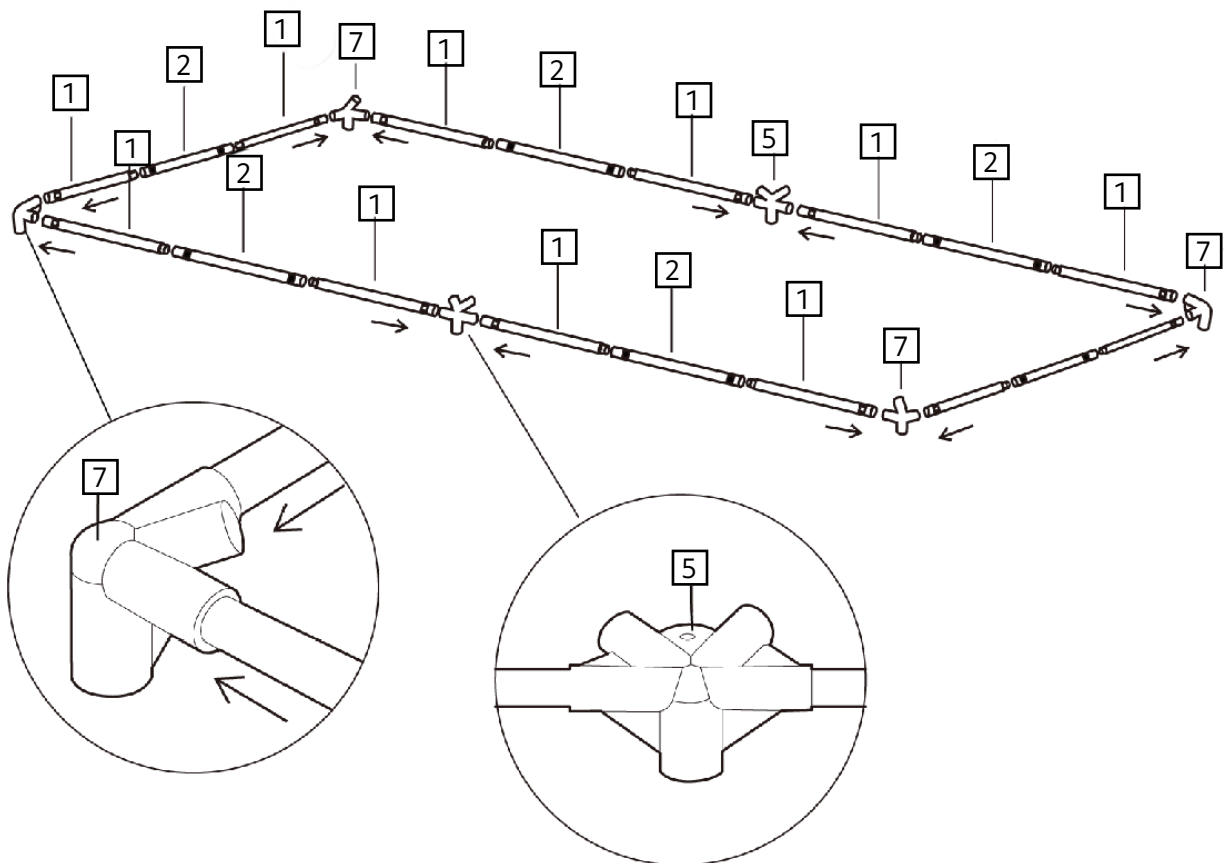

3

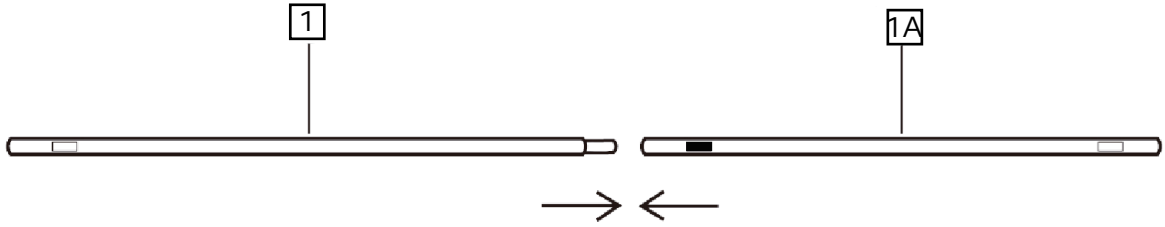

 Repeat
x8

4

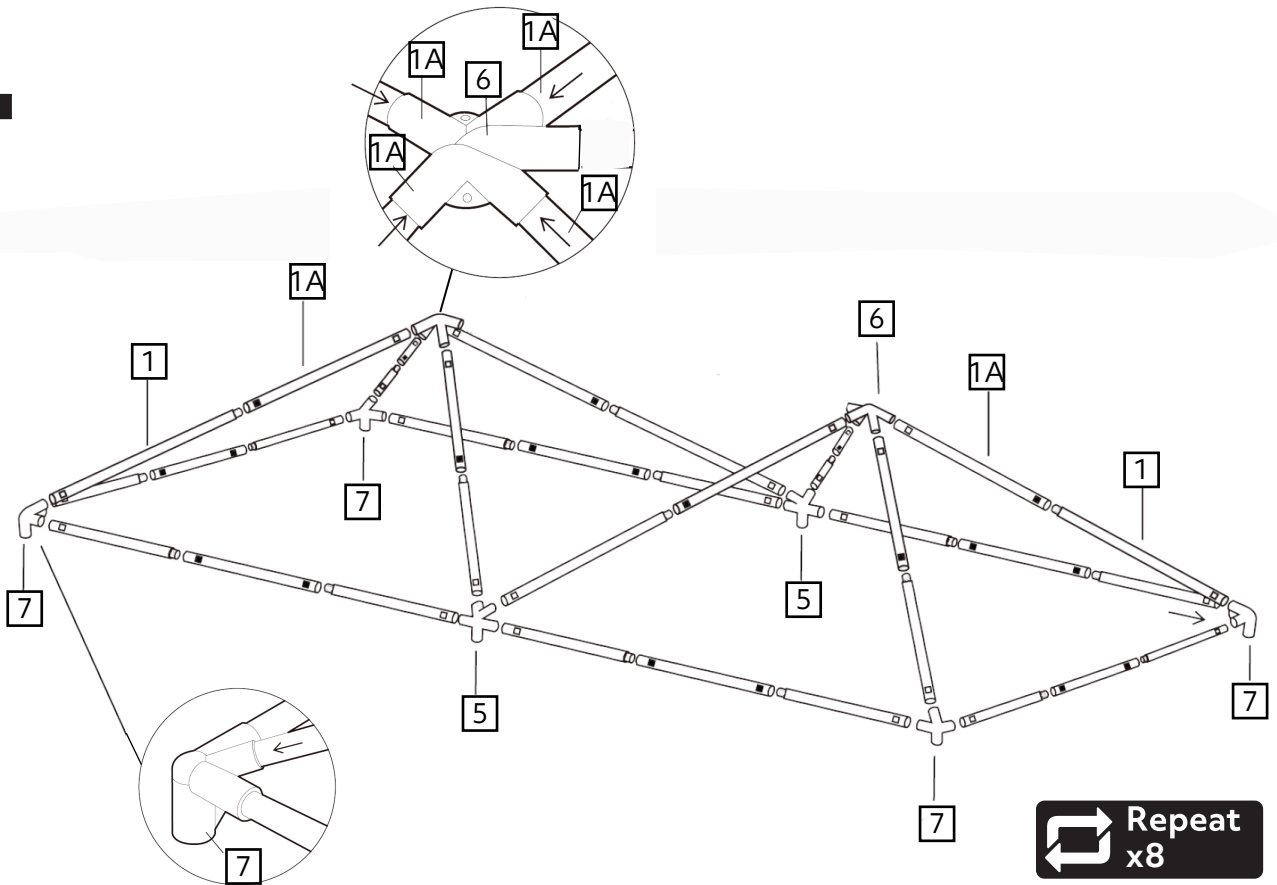

5

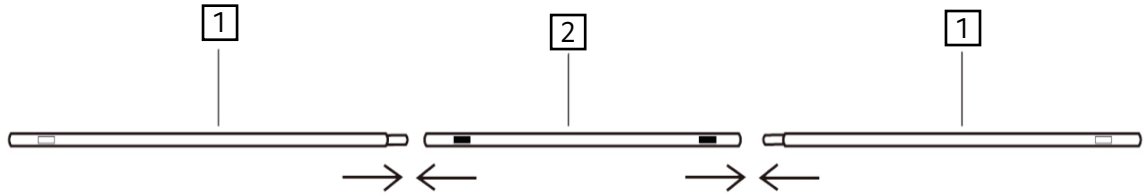

6

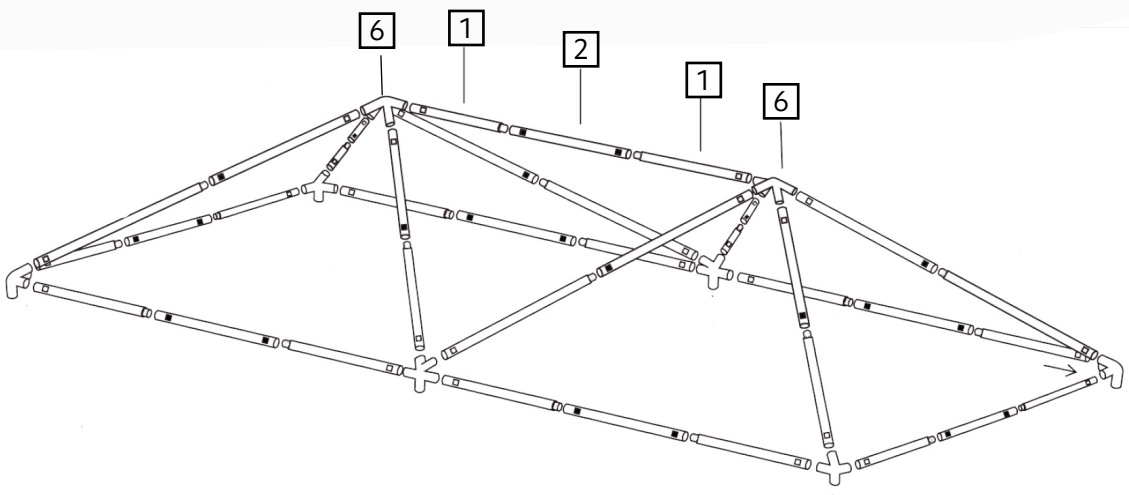

7

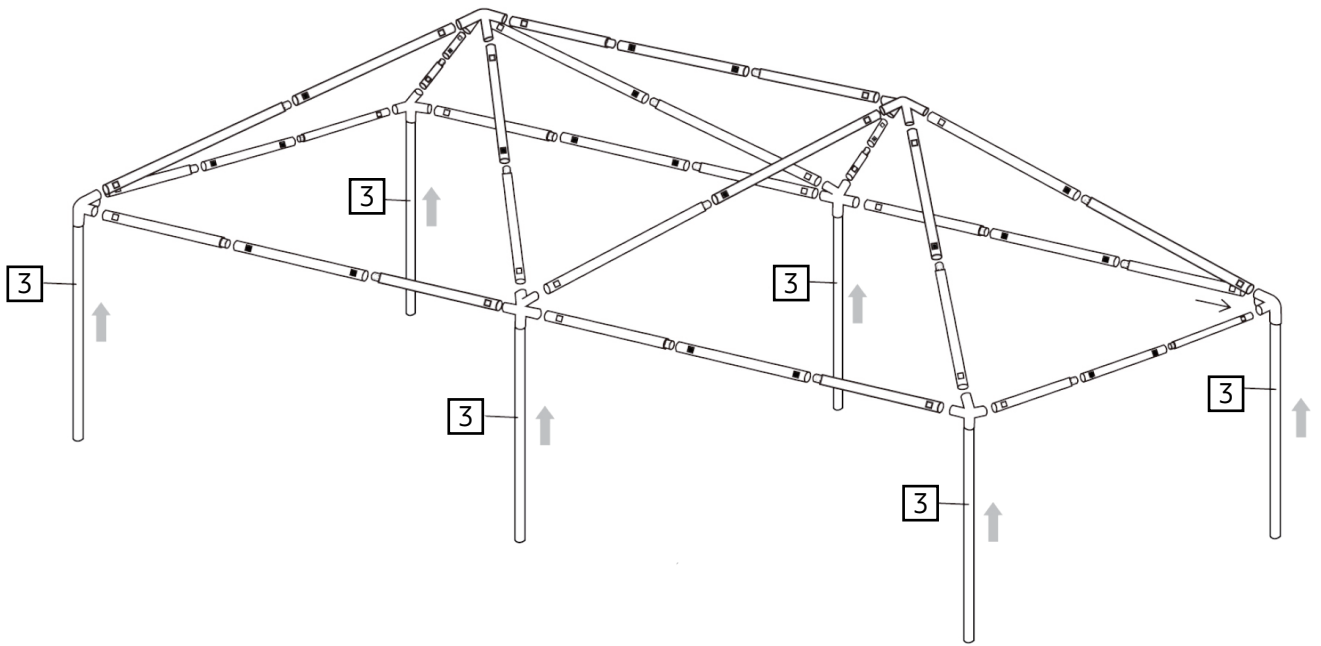

8

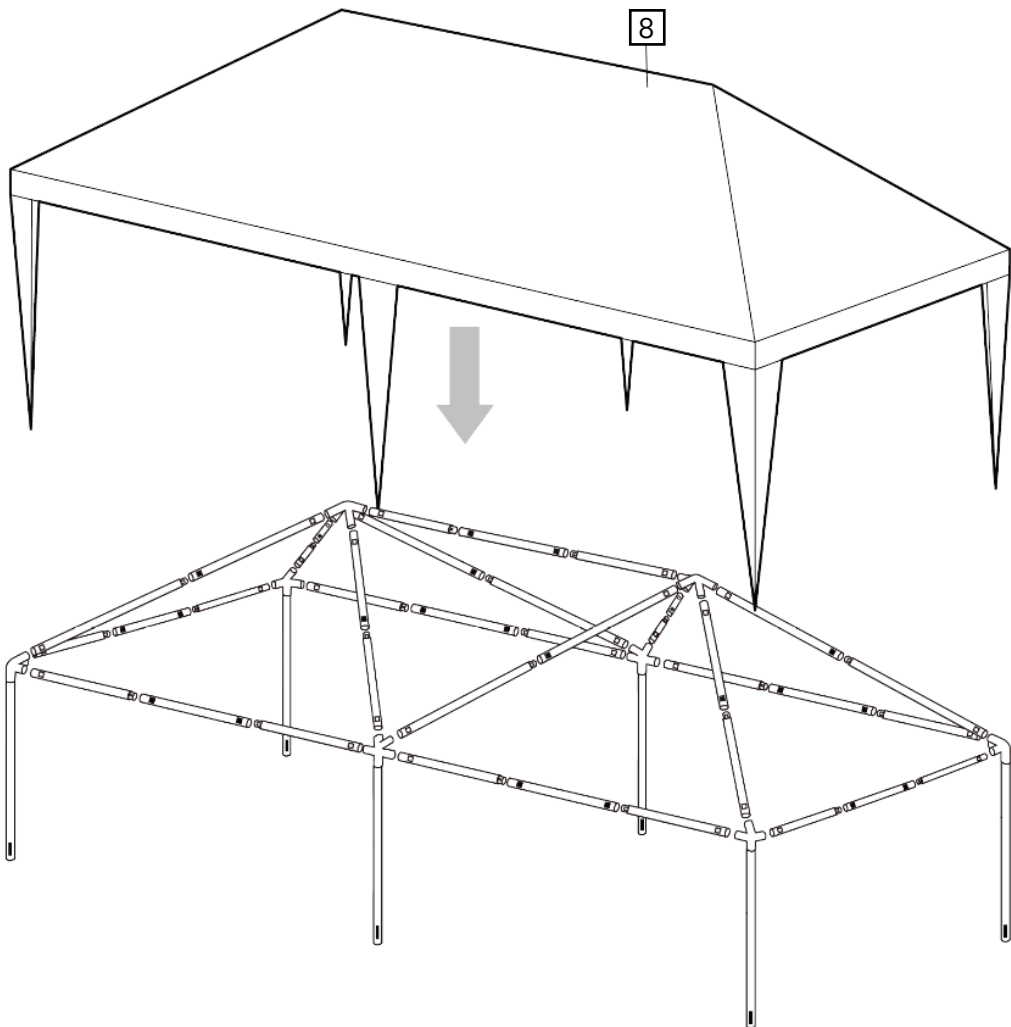

9

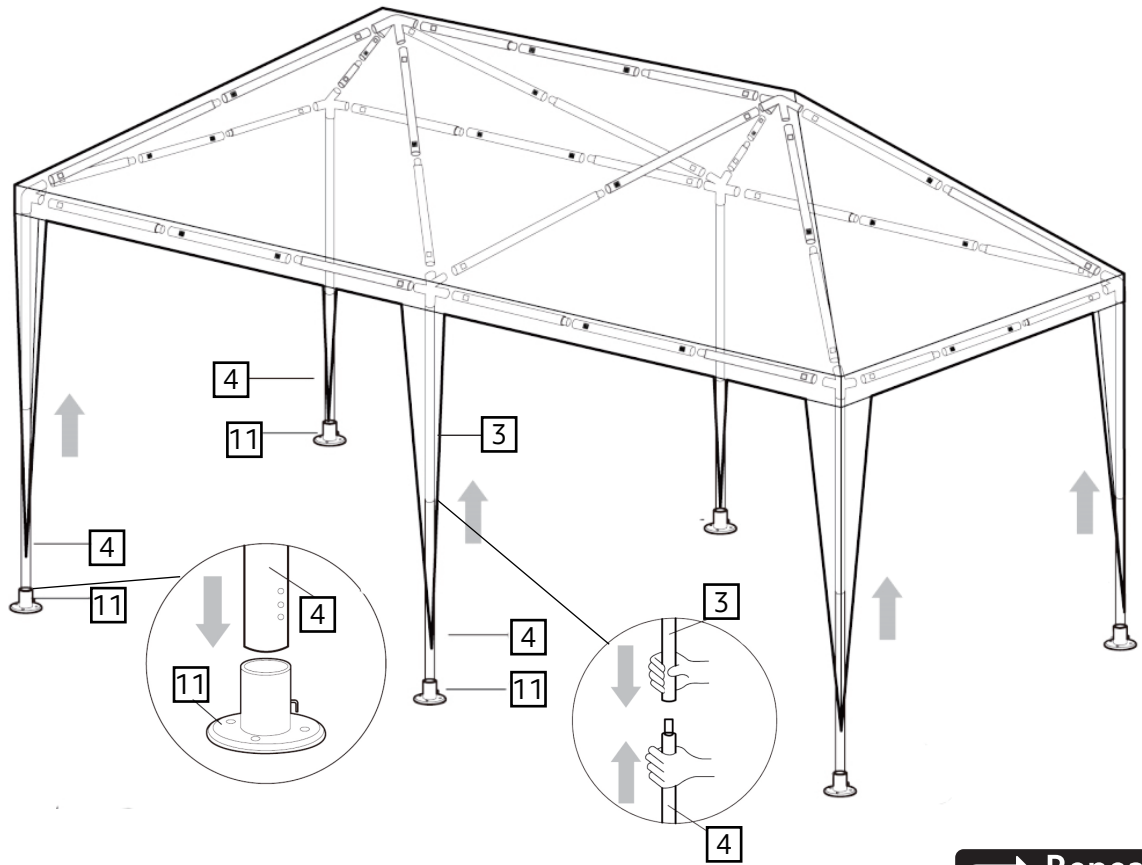

 Repeat
x6

10

WARNING!

THE VELCRO TAPE MUST STRETCH TIGHT AS THIS COULD CAUSE RAIN WATER TO COLLECT ON THE CANOPY AND A HAZARD.

 Repeat
x6

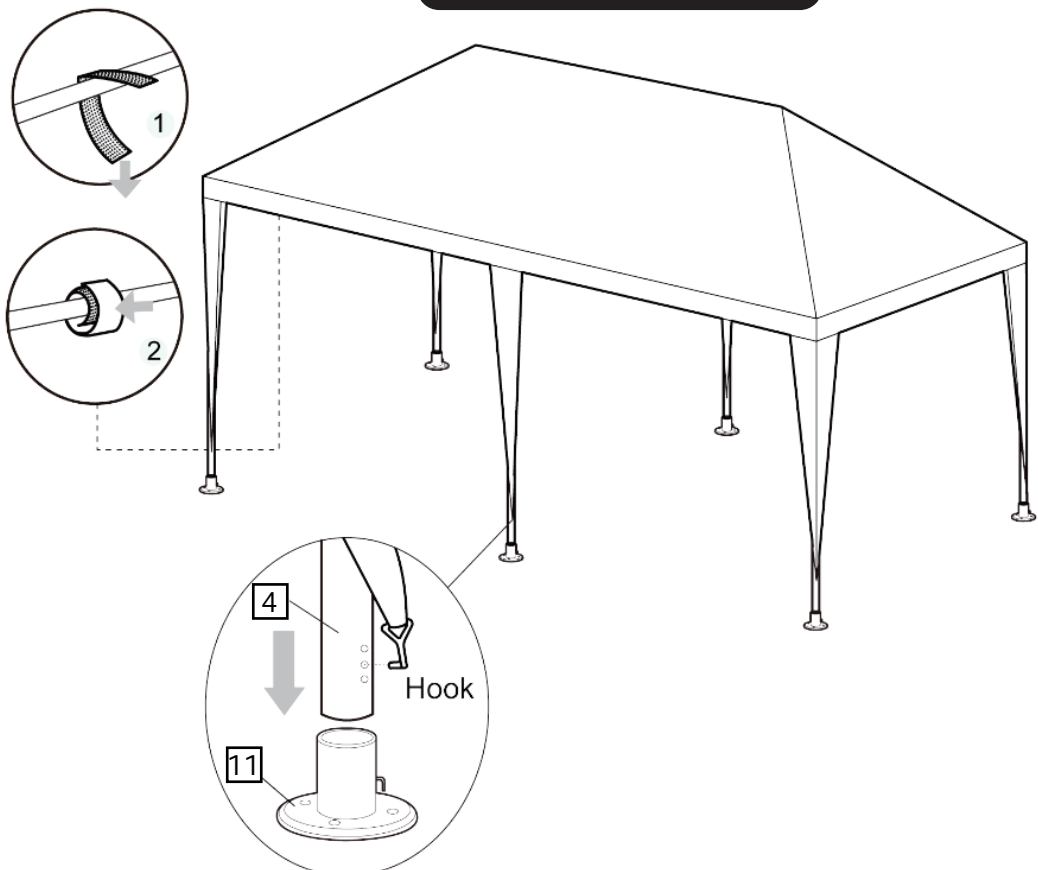

11

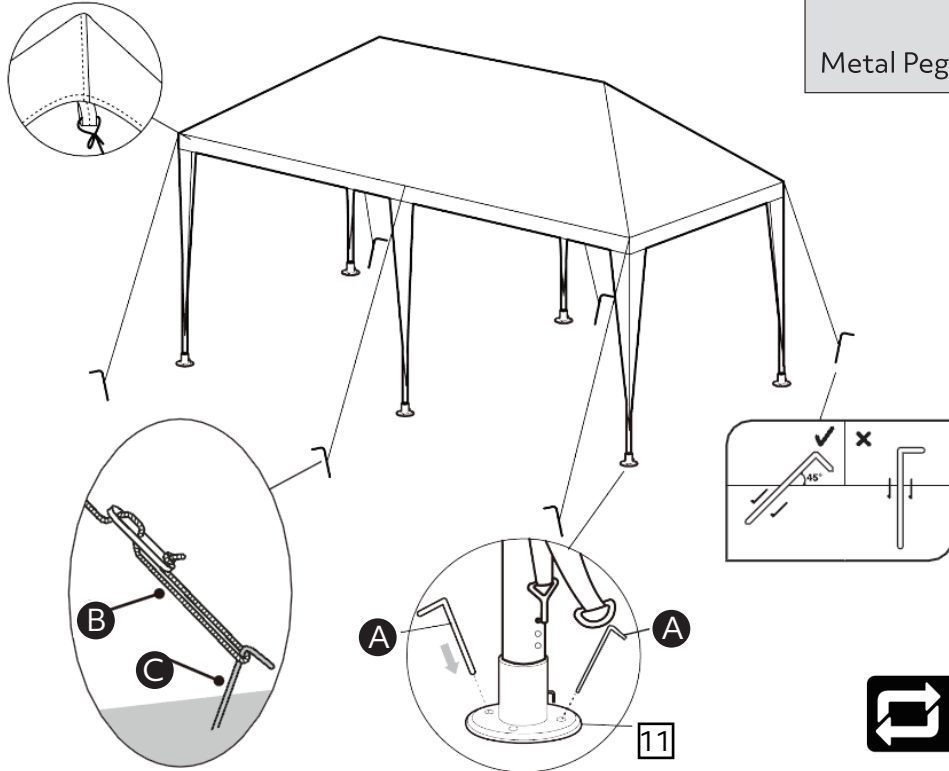
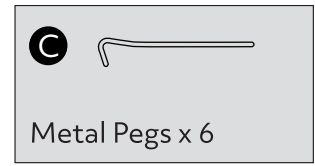
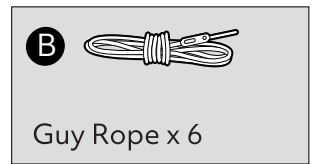
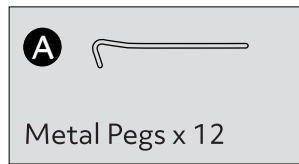
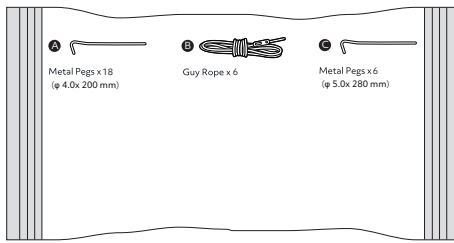

Repeat x6

12

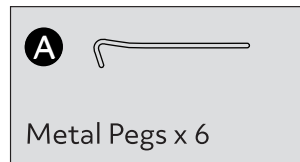
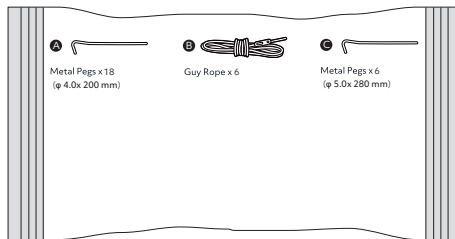

Repeat x6

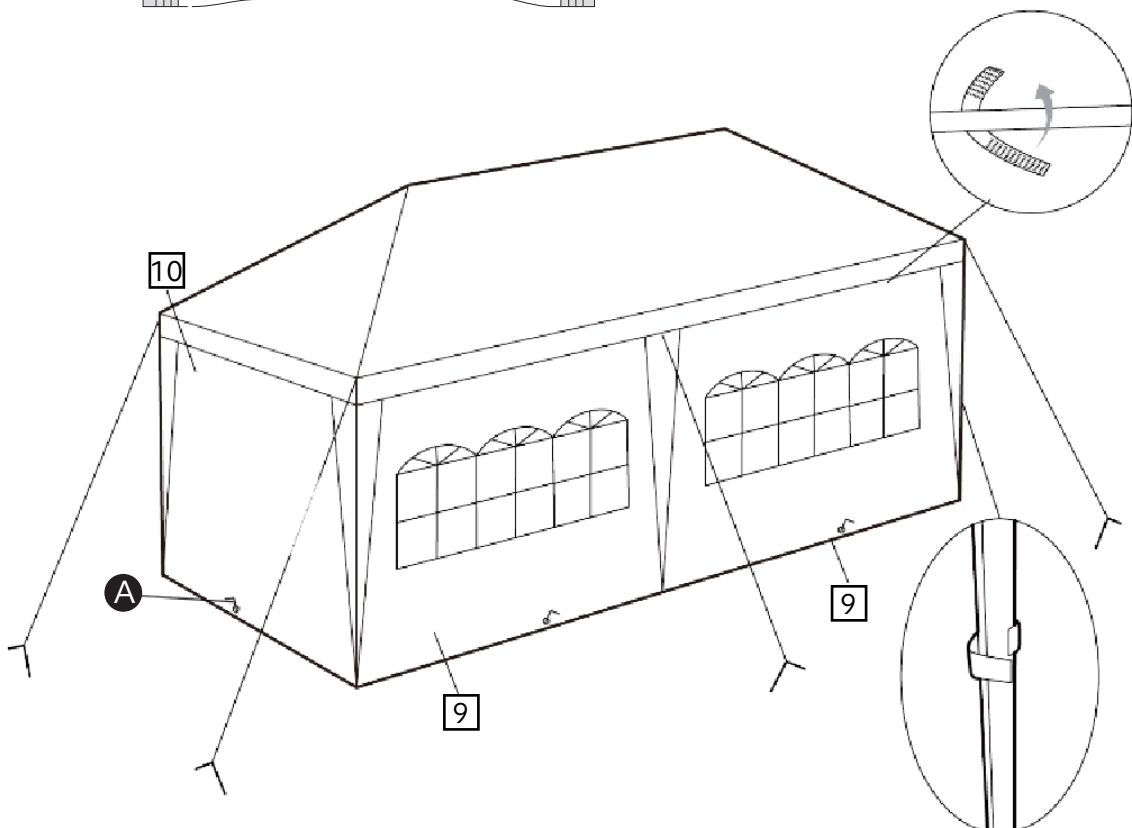

13

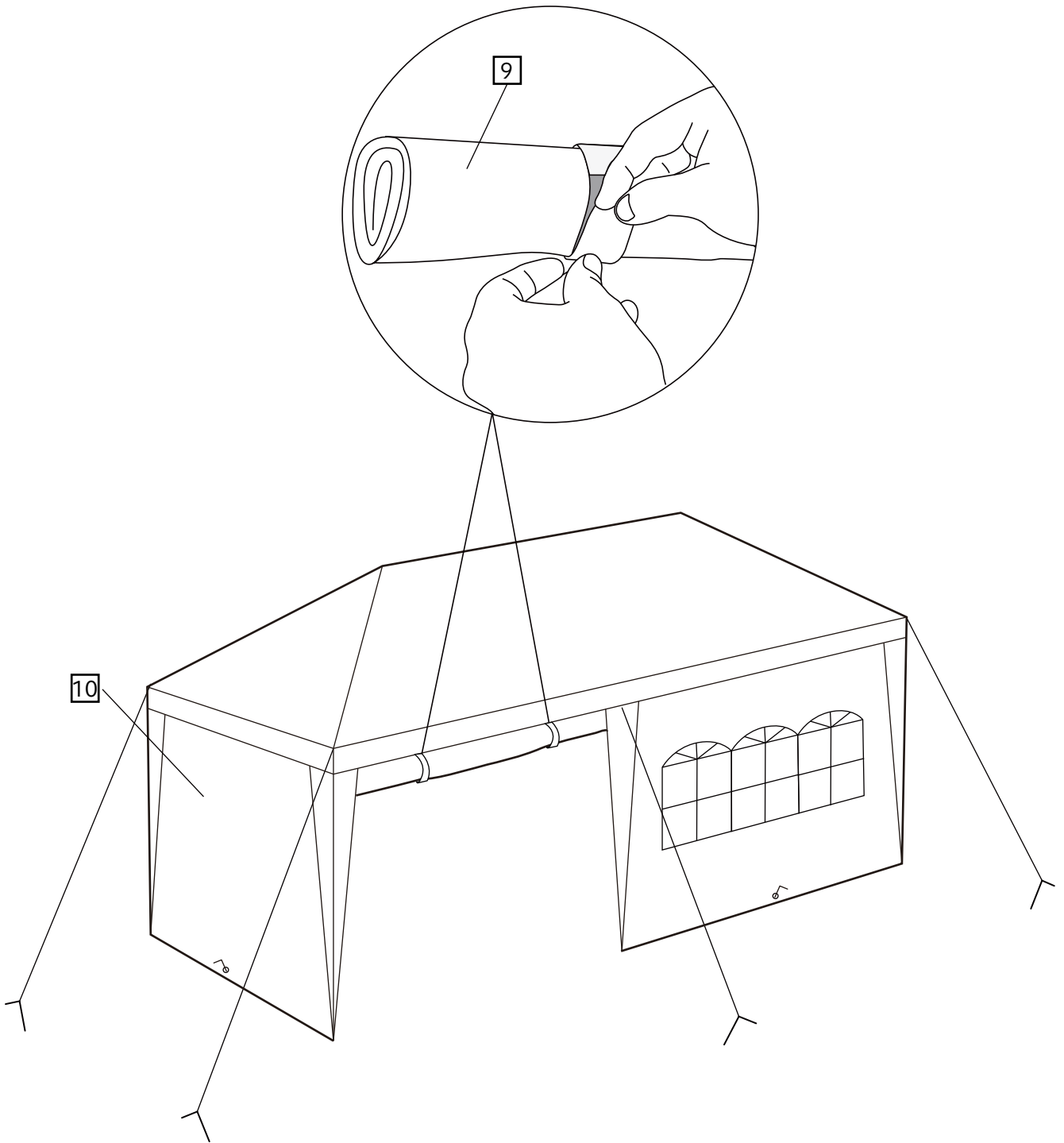

WARNING!

DO NOT ASSEMBLE OR DISASSEMBLE
DURING STRONG WINDS.

Assembly is completed