

Serpa

 habitat

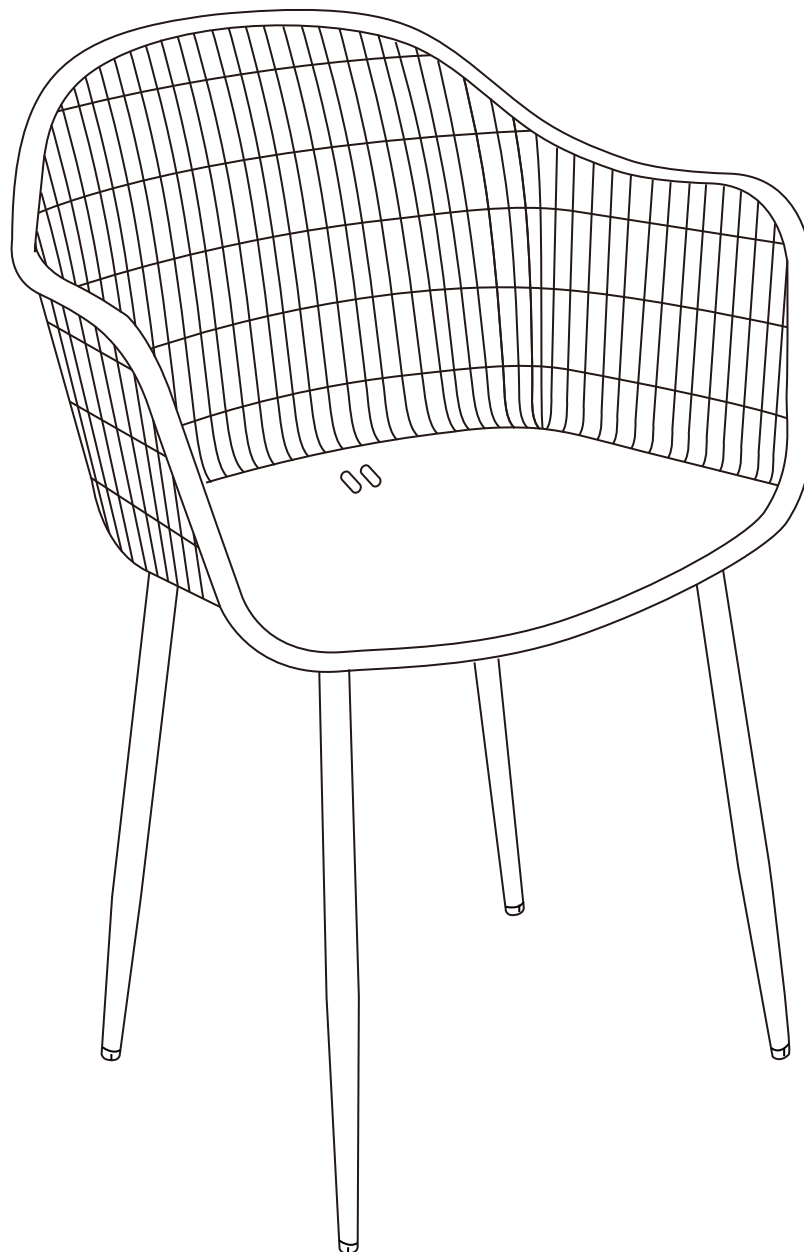

Spare Parts

 www.argos-support.co.uk

 Help@ClickSpares.co.uk

 0370112 1928

Customer Support

 03456402020

Safety and Care Advice

Product Details

Set of 2 Serpa Dining Chairs 4726469

IMPORTANT, RETAIN FOR FUTURE REFERENCE: READ CAREFULLY .

- Keep children and animals away from the work area, small parts could choke if swallowed.
- Make sure you have enough space to layout the parts before starting.
 - This product has been constructed to be used in the domestic environment only and not for commercial purposes.

- Assemble the item as close to its final position (in the same room) as possible.
- Assemble on a soft level surface to avoid damaging the unit or your floor.

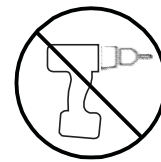

- We do not recommend the use of power drill/drivers for inserting screws as this could damage the unit. Only use hand screwdrivers.
- Parts of the assembly will be easier with 2 people.
- Dispose of all packaging carefully and responsibly.

Care and maintenance

- Only clean using a damp cloth and mild detergent. Do not use abrasive cleaners.
- Use a dry cloth to clean the product, furniture polish is not recommended.
- From time to time check that there are no loose screws, nuts or bolts. If there are please re-tighten.
- This product should not be discarded with household waste . Take to your local authority waste disposal centre.

Additional Guidance

- Assemble all parts and bolts loosely during assembly, only once the product is complete should you fully tighten the bolts.
- Regularly check and ensure that all bolts and fittings are tightened properly.
- Age recommendation for 18+
- Maximum loading weight 110kg
- This product is compliant EN581

Fittings

Bag 1

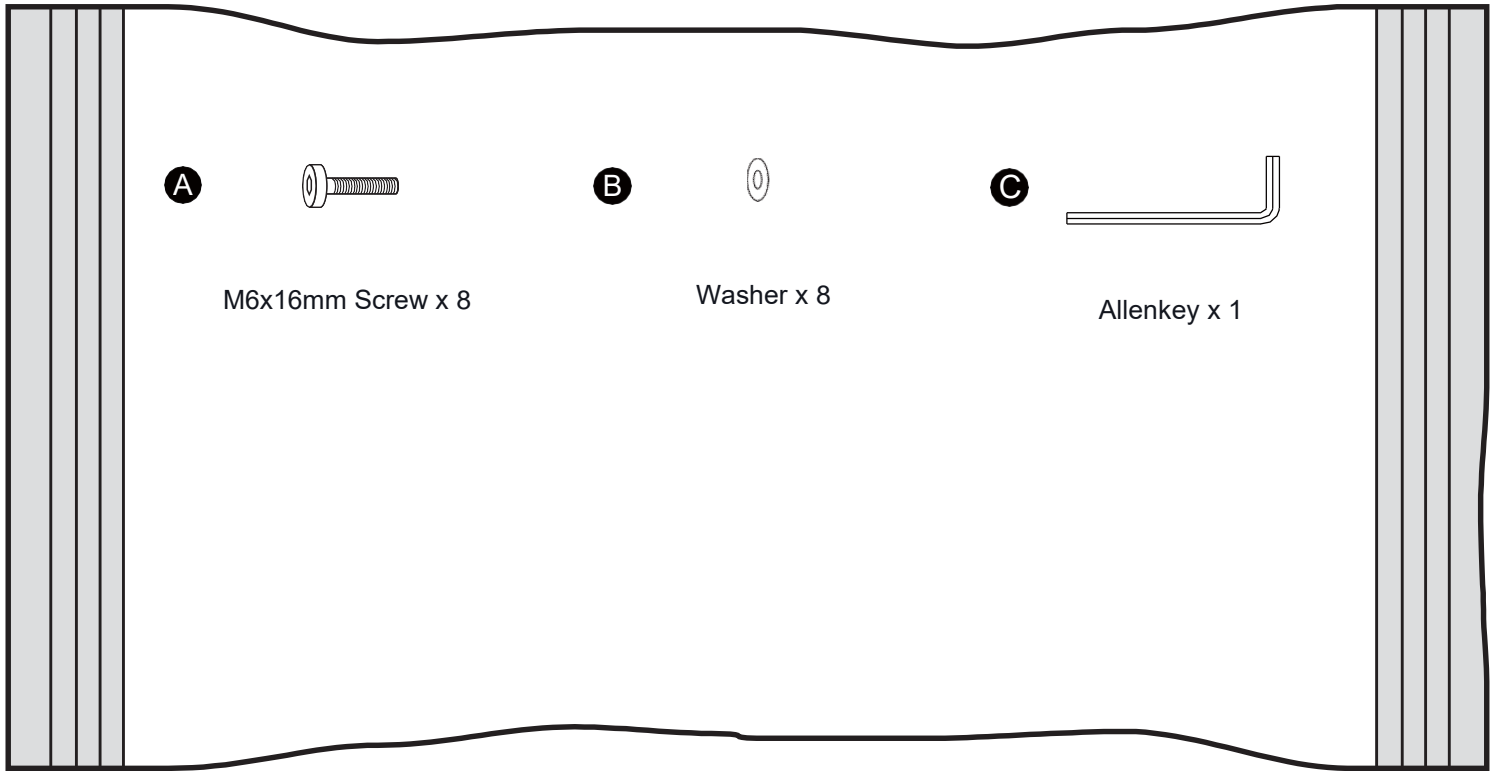

Parts

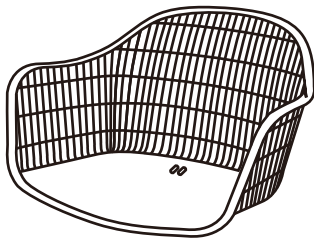

1 Chair Seat x 1

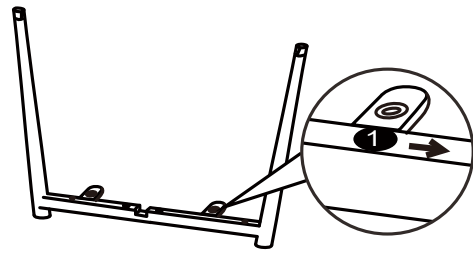

2 Leg 1x 1

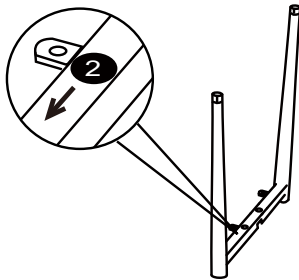

3 Leg 2 x 1

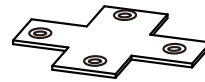

4 Cross Connector x 1

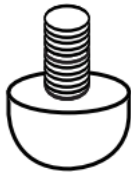

5 Adjustable foot caps x 4
(Assembled on legs)

1

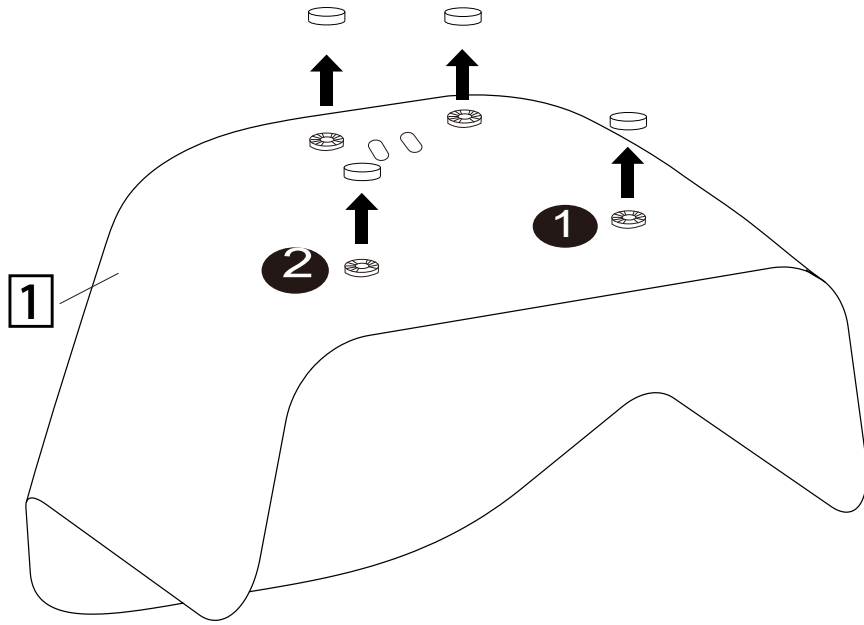

2

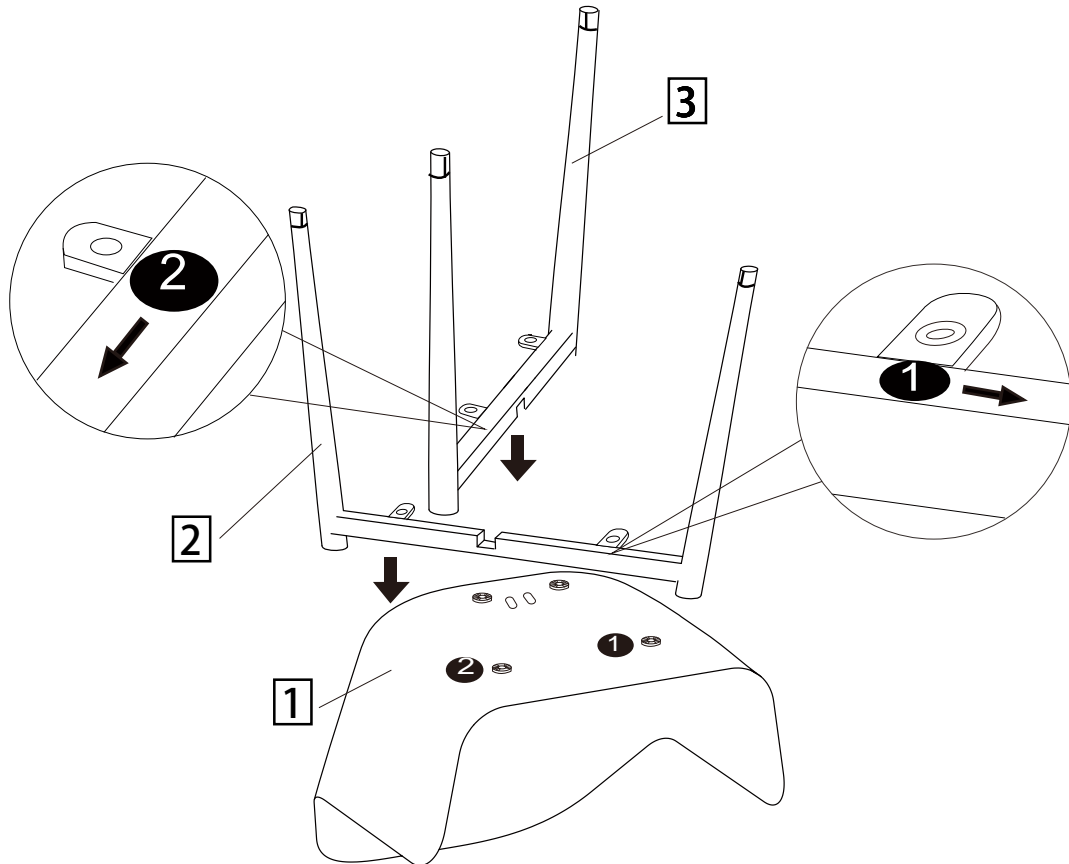

3

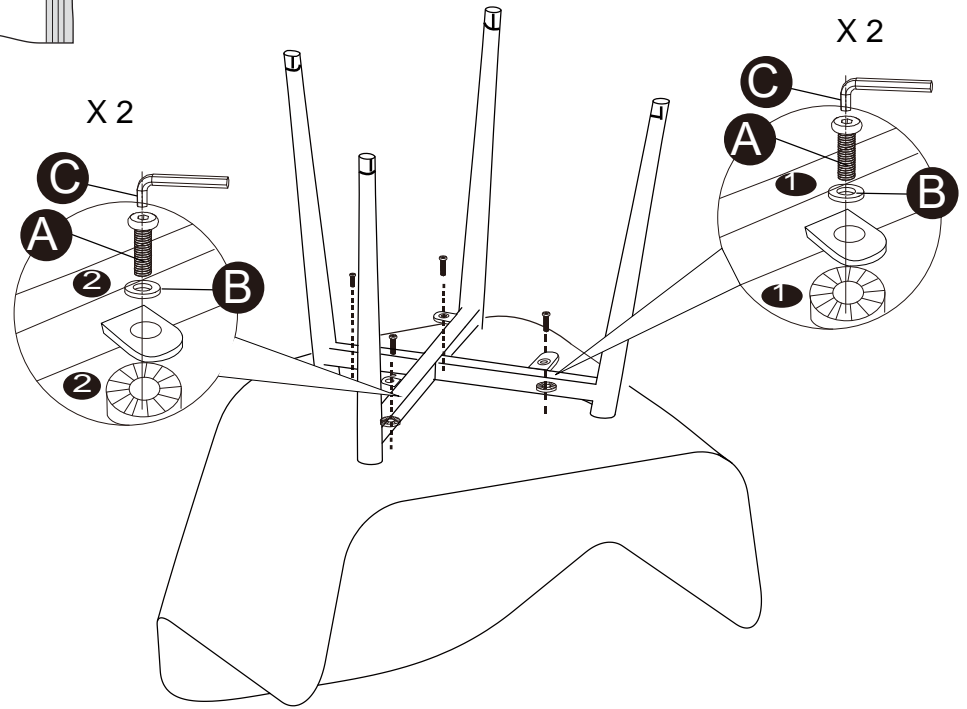
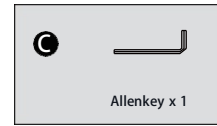
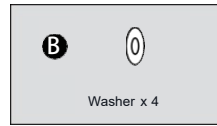
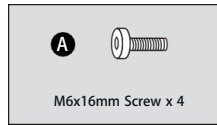
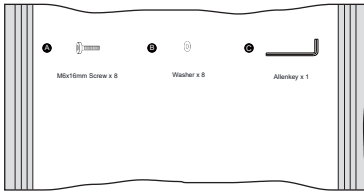

4

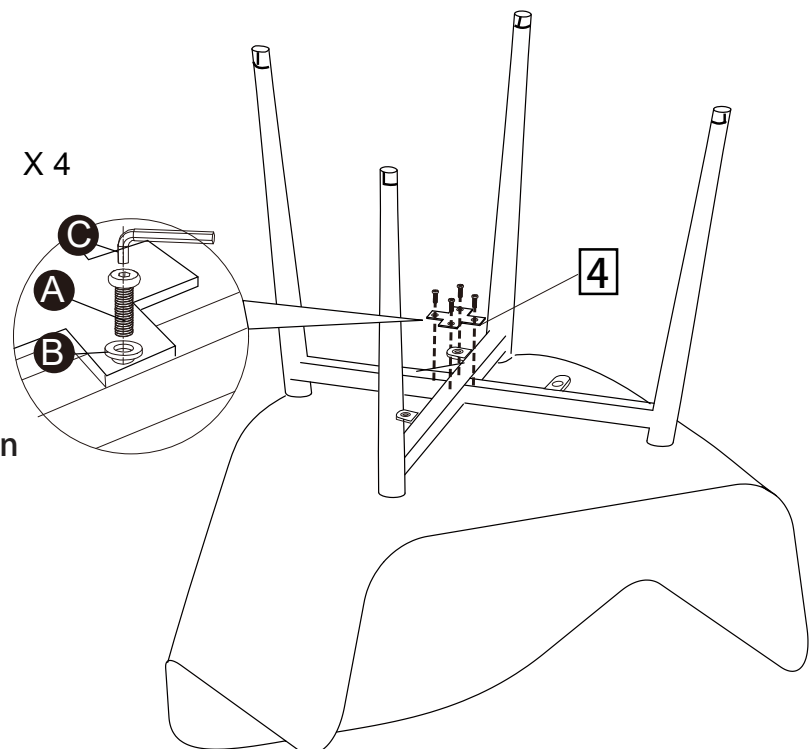

Important:
After all the parts are in position
you can now fully tighten all
screws fixed on previous steps.



5

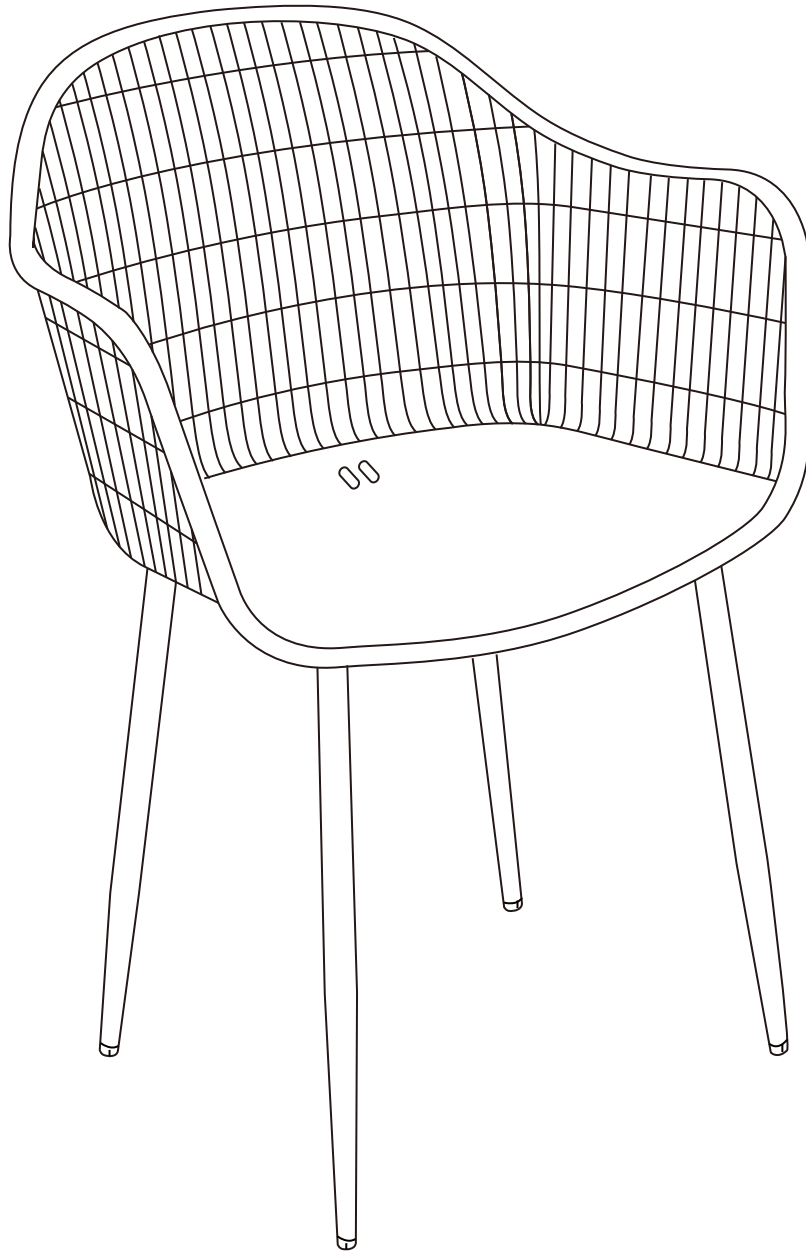

IMPORTANT

On a regular basis please check that the screws and fittings have not become loose as this could present a potential choke hazard.

Assembly is complete