

EN User Manual | **Microwave combi-oven**

ZVENM6KN

ZVENM6X3

ZVENM6XN

VISIT OUR WEBSITE TO:



Get usage advice, brochures, trouble shooter, service and repair information:
www.zanussi.com/support

Subject to change without notice.

CONTENTS

1. SAFETY INFORMATION.....	2
2. SAFETY INSTRUCTIONS.....	5
3. PRODUCT DESCRIPTION.....	8
4. CONTROL PANEL.....	9
5. BEFORE FIRST USE.....	10
6. DAILY USE.....	10
7. CLOCK FUNCTIONS.....	16
8. USING THE ACCESSORIES.....	17
9. ADDITIONAL FUNCTIONS.....	18
10. HINTS AND TIPS.....	19
11. CARE AND CLEANING.....	22
12. TROUBLESHOOTING.....	24
13. ENERGY EFFICIENCY.....	25
14. MENU STRUCTURE.....	25
15. ENVIRONMENTAL CONCERNS.....	26

1. ⚠ SAFETY INFORMATION

Before the installation and use of the appliance, carefully read the supplied instructions. The manufacturer is not responsible for any injuries or damage that are the result of incorrect installation or usage. Always keep the instructions in a safe and accessible location for future reference.

1.1 Children and vulnerable people safety

- This appliance can be used by children aged from 8 years and above and persons with reduced physical, sensory or mental capabilities or lack of experience and knowledge if they have been given supervision or instruction concerning the use of the appliance in a safe way and understand the hazards involved. Children of less than 8 years of age and persons with very extensive and complex disabilities shall

be kept away from the appliance unless continuously supervised.

- Children should be supervised to ensure that they do not play with the appliance.
- Keep all packaging away from children and dispose of it appropriately.
- **WARNING:** The appliance and its accessible parts become hot during use. Keep children and pets away from the appliance when in use and when cooling down.
- If the appliance has a child safety device, it should be activated.
- Children shall not carry out cleaning and user maintenance of the appliance without supervision.

1.2 General Safety

- This appliance is for cooking purposes only.
- This appliance is designed for single household domestic use in an indoor environment.
- This appliance may be used in, offices, hotel guest rooms, bed & breakfast guest rooms, farm guest houses and other similar accommodation where such use does not exceed (average) domestic usage levels.
- Only a qualified person must install this appliance and replace the cable.
- Do not use the appliance before installing it in the built-in structure.
- Disconnect the appliance from the power supply before carrying out any maintenance.
- If the supply cord is damaged, it must be replaced by the manufacturer, its Authorised Service Centre or similarly qualified persons to avoid an electrical hazard.
- **WARNING:** Ensure that the appliance is switched off before replacing the lamp to avoid the possibility of electric shock.
- **WARNING:** The appliance and its accessible parts become hot during use. Care should be taken to avoid touching heating elements or the surface of the appliance cavity.

- Always use oven gloves to remove or insert accessories or ovenware.
- Do not activate the microwave function when the appliance is empty. Metal parts inside the cavity can create electric arcing.
- Metallic containers for food and beverages are not allowed during microwave cooking. This requirement is not applicable if the manufacturer specifies size and shape of metallic containers suitable for microwave cooking.
- **WARNING:** If the door or door seals are damaged, the appliance must not be operated until it has been repaired by a qualified person.
- **WARNING:** Only a qualified person can carry out any service or repair operation that involves the removal of a cover which gives protection against exposure to microwave energy.
- **WARNING:** Do not heat liquids and other foods in sealed containers. They are liable to explode.
- Use only utensils that are suitable for use in microwave ovens.
- When heating food in plastic or paper containers, observe the appliance due to the possibility of ignition.
- The appliance is intended for heating food and beverages. Drying of food or clothing and heating of warming pads, slippers, sponges, damp cloth and similar may lead to risk of injury, ignition or fire.
- If smoke is emitted, switch off or unplug the appliance and keep the door closed in order to stifle any flames.
- Microwave heating of beverages can result in delayed eruptive boiling. Care must be taken when handling the container.
- The contents of feeding bottles and baby food jars shall be stirred or shaken and the temperature checked before consumption, in order to avoid burns.

- Eggs in their shell and whole hard-boiled eggs should not be heated in the appliance since they may explode, even after microwave heating has ended.
- To remove the shelf supports first pull the front of the shelf support and then the rear end away from the side walls. Install the shelf supports in the opposite sequence.
- The appliance should be cleaned regularly and any food deposits removed.
- Do not use a steam cleaner to clean the appliance.
- Do not use harsh abrasive cleaners or sharp metal scrapers to clean the glass door since they can scratch the surface, which may result in shattering of the glass.
- Failure to maintain the appliance in a clean condition could lead to deterioration of the surface that could adversely affect the life of the appliance and possibly result in a hazardous situation.

2. SAFETY INSTRUCTIONS

2.1 Installation

WARNING!

Only a qualified person must install this appliance.

- Remove all the packaging.
- Do not install or use a damaged appliance.
- Follow the installation instructions supplied with the appliance.
- Always take care when moving the appliance as it is heavy. Always use safety gloves and enclosed footwear.
- Do not pull the appliance by the handle.
- Install the appliance in a safe and suitable place that meets installation requirements.
- Keep the minimum distance from other appliances and units.
- Before mounting the appliance, check if the appliance door opens without restraint.
- The appliance is equipped with an electric cooling system. It must be operated with the electric power supply.
- The built-in unit must meet the stability requirements of DIN 68930.

Cabinet minimum height (Cabinet under the worktop minimum height)	444 (460) mm
Cabinet width	560 mm
Cabinet depth	550 (550) mm
Height of the front of the appliance	455 mm
Height of the back of the appliance	440 mm
Width of the front of the appliance	595 mm
Width of the back of the appliance	559 mm
Depth of the appliance	567 mm
Built in depth of the appliance	546 mm
Depth with open door	882 mm
Ventilation opening minimum size. Opening placed on the bottom rear side	560x20 mm

Mains supply cable length. Cable is placed in the right corner of the back side	1500 mm
---	---------

Mounting screws	3.5x25 mm
-----------------	-----------

2.2 Electrical connection

WARNING!

Risk of fire and electric shock.

- All electrical connections should be made by a qualified electrician.
- The appliance must be earthed.
- Make sure that the parameters on the rating plate are compatible with the electrical ratings of the mains power supply.
- Always use a correctly installed shockproof socket.
- Do not use multi-plug adapters and extension cables.
- Make sure not to cause damage to the mains plug and to the mains cable. Should the mains cable need to be replaced, this must be carried out by our Authorised Service Centre.
- Do not let mains cables touch or come near the appliance door or the niche below the appliance, especially when it operates or the door is hot.
- The shock protection of live and insulated parts must be fastened in such a way that it cannot be removed without tools.
- Connect the mains plug to the mains socket only at the end of the installation. Make sure that there is access to the mains plug after the installation.
- If the mains socket is loose, do not connect the mains plug.
- Do not pull the mains cable to disconnect the appliance. Always pull the mains plug.
- Use only correct isolation devices: line protecting cut-outs, fuses (screw type fuses removed from the holder), earth leakage trips and contactors.
- The electrical installation must have an isolation device which lets you disconnect the appliance from the mains at all poles. The isolation device must have a contact opening width of minimum 3 mm.
- This appliance is supplied only with a main cable.

2.3 Use

WARNING!

Risk of injury, burns and electric shock or explosion.

- Do not change the specification of this appliance.
- Make sure that the ventilation openings are not blocked.
- Do not let the appliance stay unattended during operation.
- Deactivate the appliance after each use.
- Be careful when you open the appliance door while the appliance is in operation. Hot air can release.
- Do not operate the appliance with wet hands or when it has contact with water.
- Do not apply pressure on the open door.
- Do not use the appliance as a work surface or as a storage surface.
- Open the appliance door carefully. The use of ingredients with alcohol can cause a mixture of alcohol and air.
- Do not let sparks or open flames to come in contact with the appliance when you open the door.
- Do not put flammable products or items that are wet with flammable products in, near or on the appliance.
- Do not use microwave function to preheat the appliance.

WARNING!

Risk of damage to the appliance.

- To prevent damage or discoloration to the enamel:
 - do not put aluminium foil directly on the bottom of cavity of the appliance.
 - do not put water directly into the hot appliance.
 - do not keep moist dishes and food in the appliance after you finish the cooking.
 - be careful when you remove or install the accessories.
- Discoloration of the enamel or stainless steel has no effect on the performance of the appliance.
- Use a deep pan for moist cakes. Fruit juices cause stains that can be permanent.

- Always cook with the appliance door closed.
- If the appliance is installed behind a furniture panel (e.g. a door) make sure the door is never closed when the appliance operates. Heat and moisture can build up behind a closed furniture panel and cause subsequent damage to the appliance, the housing unit or the floor. Do not close the furniture panel until the appliance has cooled down completely after use.

2.4 Care and cleaning

WARNING!

Risk of injury, fire, or damage to the appliance.

- Before maintenance, deactivate the appliance and disconnect the mains plug from the mains socket.
- Make sure the appliance is cold. There is the risk that the glass panels can break.
- Replace immediately the door glass panels when they are damaged. Contact the Authorised Service Centre.
- Be careful when you remove the door from the appliance. The door is heavy!
- Make sure the cavity and the door are wiped dry after each use. Steam produced during the operation of the appliance condensates on cavity walls and can cause corrosion.
- Clean regularly the appliance to prevent the deterioration of the surface material.
- Fat and food remaining in the appliance can cause fire and electric arcing when the microwave function operates.
- Clean the appliance with a moist soft cloth. Use only neutral detergents. Do not use abrasive products, abrasive cleaning pads, solvents or metal objects.
- If you use an oven spray, follow the safety instructions on its packaging.

2.5 Glassware use

Handling your glassware without an appropriate degree of care could result in breakage, chipping, cracking or severe scratching:

- Do not spill cold water or other liquids on the glassware because a sudden

temperature drop may cause immediate breakage of the glass. Broken glass pieces may be extremely sharp and difficult to locate.

- Do not place hot glassware on a wet or cool surface, directly on countertop or metal surface, or in sink; or handle hot glassware with wet cloth.
- Do not use or repair any glassware that is chipped, cracked or severely scratched.
- Do not drop or hit glassware against a hard object or strike utensils against it.
- Do not heat empty or nearly empty glassware in microwave, or overheat oil or butter in microwave (use minimum amount of cooking time).

Allow hot glassware to cool on a cooling rack, a potholder or a dry cloth. Make sure that the glassware is cool enough before washing, refrigerating or freezing.

Avoid handling hot glassware (including ware with silicone gripping surfaces) without dry potholders.

Avoid microwave misuse (i.e. running the oven without any load or small load).

2.6 Internal lighting

WARNING!

Risk of electric shock.

- Concerning the lamp(s) inside this product and spare part lamps sold separately: These lamps are intended to withstand extreme physical conditions in household appliances, such as temperature, vibration, humidity, or are intended to signal information about the operational status of the appliance. They are not intended to be used in other applications and are not suitable for household room illumination.
- This product contains a light source of energy efficiency class G.
- Use only lamps with the same specifications.

2.7 Service

- To repair the appliance contact the Authorised Service Centre.
- Use original spare parts only.

2.8 Disposal

WARNING!

Risk of injury or suffocation.

- Contact your municipal authority for information on how to dispose of the appliance.

- Disconnect the appliance from the mains supply.
- Cut off the mains electrical cable close to the appliance and dispose of it.
- Remove the door catch to prevent children or pets from becoming trapped in the appliance.

3. PRODUCT DESCRIPTION

3.1 General overview

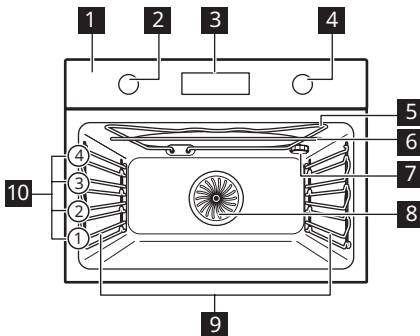

- 1 Control panel
- 2 Knob for the heating functions
- 3 Display
- 4 Control knob
- 5 Heating element
- 6 Microwave generator
- 7 Lamp
- 8 Fan
- 9 Shelf support, removable
- 10 Shelf positions

3.2 Accessories

Wire shelf

For cookware, cake tins, roasts.

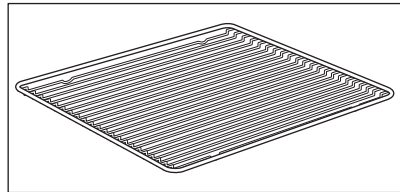

Baking tray

For cakes and biscuits.

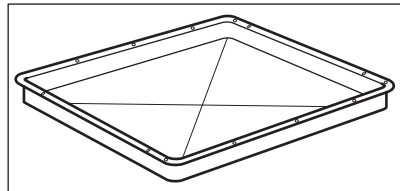

Microwave bottom glass plate
To prepare food in microwave mode.

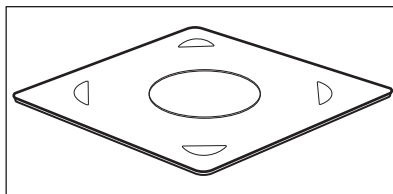

4. CONTROL PANEL

4.1 Retractable knobs

To use the appliance press the knob. The knob comes out.

4.2 Control panel overview

			WATT	OK		
Timer	Fast Heat Up	Light	Microwave power	Confirm setting	Press	Turn the knob

Select a heating function to turn on the appliance.

Turn the knob for the heating functions to the off position to turn the appliance off.

4.3 Display

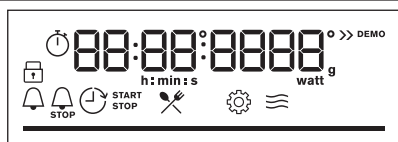

Display with key functions.

Display indicators

Basic indicators



Lock



Assisted Cooking



Settings



Microwave function indicator

Timer indicators



Minute minder



End time



Time Delay



Uptimer

Progress bar - for temperature or time. The bar is fully red when the appliance reaches the set temperature.



5. BEFORE FIRST USE

WARNING!

Refer to Safety chapters.

5.1 Initial cleaning

Before the first use, clean the empty appliance and set the time:



00:00

Set the time. Press **OK**.

6. DAILY USE

WARNING!

Refer to Safety chapters.

6.1 How to set: Heating functions

-
- Step 1** Turn the knob for the heating functions and select a heating function.
-
- Step 2** Turn the control knob to set the temperature.
Press **OK**.
-

6.2 How to set: Microwave functions

-
- Step 1** Remove all accessories.
Insert microwave bottom glass plate. Put the food on the microwave bottom glass plate.
-
- Step 2** Turn the knob for the heating functions and select the microwave function: .
-
- Step 3** Press: **OK** to start with default settings.
The display shows: duration and microwave power.
-
- Step 4** Turn the control knob to adjust the duration. Press: **OK**.
-
- Step 5** Press: **WATT**. Turn the control knob to adjust the microwave power. Press: **OK**.
-
- Step 6** Turn the knob for the heating functions to the off position to turn off the appliance.
-

You can adjust settings while cooking.



The maximum time of microwave functions depends on microwave power you set:

MICROWAVE POWER W	MAXIMUM TIME min
100 - 600	59:55
>600	7



If you open the door, the microwave function stops. To start it again, close the door. Press OK.





6.3 How to set: Microwave combi functions







- Step 1** Remove all accessories.
Insert microwave bottom glass plate. Put the food on the microwave bottom glass plate.
- Step 2** Turn the knob for the heating functions and select the function:  .
The display shows: temperature and microwave power.
- Step 3** Turn the control knob to adjust the temperature.
- Step 4** Press: **WATT**.
- Step 5** Turn the control knob to adjust the microwave power. Press: **OK**.
- Step 6** Press: **OK** to start the function.
- Step 7** Turn the knob for the heating functions to the off position to turn off the appliance.

You can adjust settings while cooking.

Turn the control knob to adjust the duration and press: **OK**.

6.4 Heating functions

Heating function	Application
 True Fan Cooking	To bake on up to two shelf positions at the same time and to dry food. Set the temperature 20 - 40 °C lower than for Conventional Cooking.
 Conventional Cooking	To bake and roast food on one shelf position.
 Turbo Grilling	To roast large meat joints or poultry with bones on one shelf position. To make gratins and to brown.
 Pizza Function	To bake pizza. To make intensive browning and a crispy bottom.

Heating function	Application
 Turbo Grilling + MW	To roast large pieces of meat on one level. To make gratins and to brown. The function with MW boost, power range: 100 - 600 W.
 True Fan Cooking + MW	Baking on one shelf position. The function with MW boost, power range: 100 - 600 W.
 Defrost	Defrosting meat, fish, cakes, power range: 100 - 200 W
 Reheat	Heating up pre-prepared meals and delicate food, power range: 300 - 700 W
 Microwave	Heating up, cooking, power range: 100 - 1000 W
 Menu	To enter the Menu: Assisted Cooking, Settings.







6.5 How to set: Assisted Cooking

The Assisted Cooking submenu consists of a set of additional functions and dishes with recommended heating functions, temperatures and times. Use the function to prepare a dish quickly with default settings. You can also adjust the time and the temperature during cooking.

When the function ends check if the food is ready.

For some of the dishes you can also cook with:

- Weight Automatic

Step 1	Step 2	Step 3	Step 4
 	 	 P1 - P...	 OK
Enter the menu.	Select Assisted Cooking. Press OK .	Select the dish. Press OK .	Insert the dish to the oven. Confirm setting.

6.6 Assisted Cooking

Legend



Weight Automatic available.

Legend



Function with microwave power. Use microwave safe accessory.

Legend

 Preheat the appliance before you start cooking.

 Shelf level.

The display shows **F** and a **number** of the function that you can check in the table.

1 Grill To grill thin pieces of food and to toast bread.









2 Bottom Heat To bake cakes with crispy bottom and to preserve food.

























3 Frozen Foods To make convenience food (e.g., french fries, potato wedges or spring rolls) crispy.



























4 Conventional Cooking + MW Baking and roasting food on one shelf position. The function with MW boost, power range: 100 - 600 W.

5 Grill + MW To cook food in a short time and to brown it. The function with MW boost, power range: 100 - 600 W.

The display shows **P** and a **number** of the dish that you can check in the table.





	Dish	Weight	Shelf level / Accessory
1	Roast Beef, rare		
2	Roast Beef, medium	1 - 1.5 kg; 4 - 5 cm thick pieces	  1; baking tray
3	Roast Beef, well done		Fry the meat for a few minutes on a hot pan. Insert to the appliance.
4	Steak, medium		180 - 220 g per piece; 3 cm thick slices
5	Beef roast / braised (prime rib, top round, thick flank)	1.5 - 2 kg	  1; roasting dish on wire shelf
6	Roast Beef, rare (slow cooking)		
7	Roast Beef, medium (slow cooking)	1 - 1.5 kg; 4 - 5 cm thick pieces	  1; baking tray
8	Roast Beef, well done (slow cooking)		Use your favourite spices or simply salt and fresh ground pepper. Fry the meat for a few minutes on a hot pan. Insert to the appliance.
9	Fillet, rare (slow cooking)		
10	Fillet, medium (slow cooking)	0,5 - 1.5 kg; 5 - 6 cm thick pieces	  1; baking tray
11	Fillet, done (slow cooking)		Use your favourite spices or simply salt and fresh ground pepper. Fry the meat for a few minutes on a hot pan. Insert to the appliance.
12	Veal roast (e.g. shoulder)		0.8 - 1.5 kg; 4 cm thick pieces

	Dish	Weight	Shelf level / Accessory
13	Pork roast neck or shoulder	1.5 kg	  1; ceramic or glass casserole dish on wire shelf , MW suitable Use your favourite spices. Turn the meat after half of the cooking time.
14	Pulled pork (slow cooking)	1.5 - 2 kg	  1; baking tray Use your favourite spices. Turn the meat after half of the cooking time to get an even browning.
15	Loin, fresh	1 - 1.5 kg; 5 - 6 cm thick pieces	  1; roasting dish on wire shelf Use your favourite spices.
16	Spare Ribs	2 - 3 kg; use raw, 2 - 3 cm thin spare ribs	 2; deep pan Add liquid to cover the bottom of a dish. Turn the meat after half of the cooking time.
17	Lamb leg with bones	1.5 - 2 kg; 7 - 9 cm thick pieces	 1; roasting dish on baking tray Fry the meat for a few minutes on a hot pan. Add liquid. Turn the meat after half of the cooking time.
18	Whole chicken	1 - 1.5kg; fresh	  1; ceramic or glass casserole dish on wire shelf , MW suitable Use your favourite spices. Put the chicken breast-side down and turn it over after half of the cooking time.
19	Half chicken	0.5 - 0.8 kg	  2; baking tray Use your favourite spices.
20	Chicken breast	180 - 200 g per piece	  1; casserole dish on wire shelf Use your favourite spices. Fry the meat for a few minutes on a hot pan.
21	Chicken legs, fresh	250 - 400 g	 2; baking tray If you marinated chicken legs first, set lower temperature and cook them longer.
22	Duck, whole	1.5 - 2.5 kg	  1; roasting dish on wire shelf Use your favourite spices. Put the meat on roasting dish. Turn the duck after half of the cooking time.
23	Goose, breast	1kg	  1; roasting dish on wire shelf Use your favourite spices. Turn the goose after half of the cooking time.
24	Meat loaf	1 kg	  1; wire shelf Use your favourite spices.
25	Whole fish, grilled	0.5 - 1 kg per fish	  1; baking tray Fill the fish with butter and use your favourite spices and herbs.
26	Fish fillet	-	  2; casserole dish on wire shelf Use your favourite spices.

	Dish	Weight	Shelf level / Accessory
27	Cheesecake	-	 1;  28 cm springform tin on wire shelf
28	Apple cake	-	 2; baking tray
29	Apple tart	-	 1; pie form on wire shelf
30	Apple pie	-	 1;  22 cm pie form on wire shelf
31	Brownies	2 kg of dough	 2; deep pan
32	Chocolate muffins	-	 2; muffin tray on wire shelf
33	Loaf cake	-	 1; loaf pan on wire shelf
34	Baked potatoes	1 kg	 1; baking tray Put the whole potatoes with skin on baking tray.
35	Wedges	1 kg	 2; baking tray lined with baking paper Use your favourite spices. Cut potatoes into pieces.
36	Grilled mixed vegetables	1 - 1.5 kg	 2; baking tray lined with baking paper Use your favourite spices. Cut the vegetables into pieces.
37	Croquets, frozen	0.5 kg	 2; baking tray
38	Pommes, frozen	0.75 kg	 2; baking tray
39	Meat / vegetable lasagna with dry pasta sheets	1 - 1.5 kg	  1; ceramic or glass casserole dish on wire shelf , MW suitable
40	Potato gratin (raw potatoes)	1.1 kg	  2; ceramic or glass casserole dish on wire shelf , MW suitable Rotate the dish after half of the cooking time.
41	Pizza fresh, thin	-	 1; baking tray lined with baking paper
42	Pizza fresh, thick	-	  1; baking tray lined with baking paper
43	Quiche	-	 1; baking tin on wire shelf
44	Baguette / Ciabatta / White bread	0.8 kg	  1; baking tray lined with baking paper More time needed for white bread.
45	All grain / rye / dark bread all grain in loaf pan	1 kg	  1; baking tray lined with baking paper / wire shelf



7. CLOCK FUNCTIONS







7.1 Clock functions

Clock Function	Application
 Minute minder	When the timer ends, the signal sounds.
 Cooking time	When the timer ends, the signal sounds and the heating function stops.
 Time Delay	To postpone the start and / or end of cooking.
 Uptimer	Maximum is 23 h 59 min. This function has no effect on the operation of the oven. To turn on and off the Uptimer select: Menu, Settings.

Clock functions are available only for: True Fan Cooking, Conventional Cooking, Turbo Grilling, Pizza Function, Turbo Grilling + MW, True Fan Cooking + MW.

7.2 How to set: Clock functions

How to set: Time of day		
Step 1	Step 2	Step 3
		
To change the time of day enter the menu and select Settings, Time of day.	Set the clock.	Press: OK .

How to set: Minute minder		
Step 1	Step 2	Step 3
		
Press:  .	Set the Minute minder	Press: OK .
<p>The display shows: 0:00 </p>		
<p> Timer starts counting down immediately.</p>		

How to set: Cooking time

Step 1



Choose a heating function and set the temperature.

Step 2



Press repeatedly:



The display shows:
0:00



Step 3



Set the cooking time.

Step 4



Press: OK.

Timer starts counting down immediately.

How to set: Time Delay

Step 1



Select the heating function.

Step 2



Press repeatedly:

Step 3



Set the start time.

Step 4



Press: OK.

The display shows: the time of day



START

The display shows:
--:--



STOP

Step 5



Set the end time.

Step 6



Press: OK.

Timer starts counting down at a set start time.

8. USING THE ACCESSORIES

WARNING!

Refer to Safety chapters.

8.1 Inserting accessories

Use only suitable cookware and material.
Refer to "Hints and tips" chapter, Microwave suitable cookware and materials.

A small indentation at the top increases safety. The indentations are also anti-tip devices. The high rim around the shelf prevents cookware from slipping of the shelf.

Wire shelf:

Push the shelf between the guide bars of the shelf support and make sure that the feet point down.

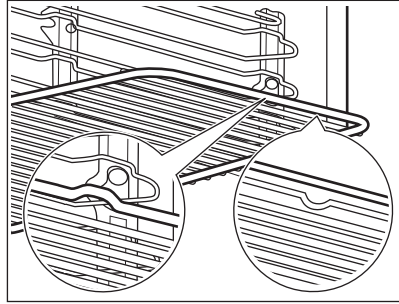

Baking tray:

Push the tray between the guide bars of the shelf support.

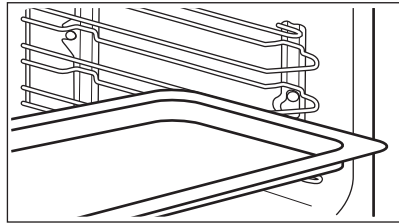

Microwave bottom glass plate:

Use the microwave bottom glass plate only with microwave function. It is not suitable for combined microwave function (e.g. microwave grilling). Put the accessory on the bottom of the cavity. You can put the food directly on the microwave bottom glass plate.

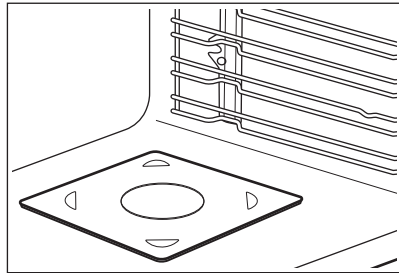

9. ADDITIONAL FUNCTIONS

9.1 Lock

This function prevents an accidental change of the appliance function.

Turn it on when the appliance works - the set cooking continues, the control panel is locked.
Turn it on when the appliance is off - it cannot be turned on, the control panel is locked.





 OK - press and hold to turn on the function.
A signal sounds.

 OK - press and hold to turn it off.

 3 x  - flashes when the lock is turned on.

9.2 Automatic switch-off

For safety reasons the appliance turns off after some time, if a heating function works and you do not change any settings.

 (°C)	 (h)
30 - 115	12.5
120 - 195	8.5



(°C)

200 - 230



(h)

5.5

The Automatic switch-off does not work with the functions: Light, Time Delay.

9.3 Cooling fan

When the appliance operates, the cooling fan turns on automatically to keep the surfaces of the appliance cool. If you turn off the appliance, the cooling fan can continue to operate until the appliance cools down.

10. HINTS AND TIPS

10.1 Cooking recommendations



The temperature and cooking times in the tables are guidelines only. They depend on the recipes and the quality and quantity of the ingredients used.

Your appliance may bake or roast differently to the appliance you had before. The hints below show recommended settings for temperature, cooking time and shelf position for specific types of the food.

If you cannot find the settings for a special recipe, look for the similar one.

10.2 Microwave recommendations

Let's cook!

Place the food on the microwave bottom glass plate on the bottom of the cavity.

Place the food on a plate on the bottom of the cavity.

Turn or stir the food halfway through the defrosting and cooking time.

Stir liquid dishes from time to time.

Stir the food before serving.

Cover the food for cooking and reheating.

Put the spoon to the bottle or glass when heating drinks to ensure better heat distribution.

Put the food into the appliance without packaging. The packaged ready meals can be put into the appliance only when the packaging is microwave safe (check information on the packaging).



Microwave cooking

Cook food covered. If you want to keep a crust cook food without a cover.

Do not overcook the dishes by setting the power and time too high. The food can dry out, burn or cause fire.

Do not use the appliance to cook eggs or snails in their shells, because they can burst. Pierce the yolk of fried egg before reheating it.

Pierce food with skin or peel several times before cooking.

Cut vegetables into similar-sized pieces.

After you turn off the appliance, take the food out and let it stand for a few minutes to allow the heat distribute evenly.



Microwave defrosting

Put the frozen, unwrapped food on a small upturned plate with a container below it, or on





a defrosting rack or plastic sieve so that the defrosting liquid can leak out.

Remove defrosted pieces subsequently.

To cook fruit and vegetables without defrosting them first, you can use a higher microwave power.

10.3 Microwave suitable cookware and materials

For the microwave use only suitable cookware and materials. Use below table as a reference. Check the cookware / material specification before use.

Cookware / Material		 	 
Ovenproof glass and porcelain with no metal components, e.g. heat-proof glass	✓	✓	✓
Non-ovenproof glass and porcelain without any silver, gold, platinum or other metal decorations	✓	x	x
Glass and glass ceramic made of ovenproof / frost-proof material	✓	✓	✓
Ovenproof ceramic and earthenware without any quartz or metal components and glazes which contain metal	✓	✓	✓
Ceramic, porcelain and earthenware with unglazed bottom or with small holes, e.g. on handles	x	x	x
Heat-resistant plastic up to 200 °C	✓	✓	x
Cardboard, paper	✓	x	x
Clingfilm	✓	x	x
Microwave clingfilm	✓	✓	x
Roasting dishes made of metal, e.g. enamel, cast iron	x	x	x
Baking tins, black lacquer or silicon-coated	x	x	x
Baking tray	x	x	x
Wire shelf	x	x	✓
Microwave glass bottom plate	✓	✓	x
Cookware for microwave use, e.g. crisp pan	x	✓	x

10.4 Recommended power settings for different kinds of food

The data in the table is for guidance only.

700 - 1000 W



Searing at the start of the cooking process



Heating liquids

500 - 600 W



Cooking vegetables



Cooking egg dishes



Simmering stews



Heating one-plate meals



Defrosting and heating frozen meals

300 - 400 W



Melting cheese, chocolate, butter



Simmering rice



Heating baby food



Cooking / Heating delicate food



Continuing cooking

100 - 200 W



Defrosting bread



Defrosting fruit and cakes



Defrosting cheese, cream, butter



Defrosting meat, fish







10.5 Cooking tables for test institutes







Information for test institutes

Tests according to IEC 60705.

Microwave function







Use wire shelf unless otherwise specified.

					
Sponge cake	600	0.475	Bottom	8 - 9	Turn container around by 1/4, halfway through the cooking time.
Meatloaf	400	0.9	1	25 - 27	Turn container around by 1/4, halfway through the cooking time.
Egg custard	500	1	2	30 - 33	-

					
Meat defrosting	100	0.5	1	15	Turn the meat upside down halfway through the cooking time.

Microwave Combi function

Use the wire shelf.

						
Cake, 0.7 kg	Conventional Cooking + MW	100	200	2	23 - 27	Turn container around by 1/4, halfway through the cooking time.
Potato gratin, 1.1 kg	True Fan Cooking + MW	300	180	2	38 - 42	Turn container around by 1/4, halfway through the cooking time.
Chicken, 1.1 kg	Turbo Grilling + MW	400	230	1	35 - 40	Put the meat in round glass container and turn it upside down halfway through the cooking time.

11. CARE AND CLEANING

WARNING!

Refer to Safety chapters.

11.1 Notes on cleaning



Cleaning Agents

Clean the front of the appliance only with a microfibre cloth with warm water and a mild detergent.

Use a cleaning solution to clean metal surfaces.

Clean stains with a mild detergent.



Everyday Use

Clean the cavity after each use. Fat accumulation or other residue may cause fire. Clean the appliance ceiling carefully from residue and fat.

Do not store the food in the appliance for longer than 20 minutes. Dry the cavity only with a microfibre cloth after each use.



Clean all accessories after each use and let them dry. Use only a microfibre cloth with warm water and a mild detergent. Do not clean the accessories in a dishwasher.

Do not clean the non-stick accessories using abrasive cleaner or sharp-edged objects.

Accessories

11.2 How to remove: Shelf supports

Remove the shelf supports to clean the oven.

Step 1 Turn off the oven and wait until it is cold.

Step 2 Carefully pull the shelf supports up and out of the front catch.

Step 3 Pull the front end of the shelf support away from the side wall.

Step 4 Pull the supports out of the rear catch.

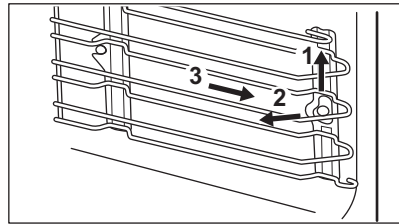

Install the shelf supports in the opposite sequence.

11.3 How to replace: Lamp



WARNING!

Risk of electric shock.
The lamp can be hot.

Always hold the halogen lamp with a cloth to prevent grease residue from burning on the lamp.

Before you replace the lamp:

Step 1

Turn off the oven. Wait until the oven is cold.

Step 2

Disconnect the oven from the mains.

Step 3

Put a cloth on the bottom of the cavity.

Top lamp

Step 1 Turn the glass cover to remove it.

Step 2 Clean the glass cover.

Step 3 Replace the lamp with a suitable 300 °C heat-resistant lamp.

Step 4 Install the glass cover.

12. TROUBLESHOOTING

WARNING!

Refer to Safety chapters.

12.1 What to do if...

In any cases not included in this table please contact with an Authorised Service Centre.



The appliance does not turn on or does not heat up

Problem	Check if...
You cannot activate or operate the appliance.	The appliance is correctly connected to an electrical supply.
The appliance does not heat up.	The automatic switch-off is deactivated.
The appliance does not heat up.	The fuse is not blown.
The appliance does not heat up.	The Lock is off.



Components

Problem	Check if...
The lamp does not work.	The lamp is burnt out.



Error codes

The display shows...	Check if...
00:00	There was a power cut. Set the time of day.

If the display shows an error code that is not in this table turn the house fuse off and on to restart the appliance. If the error code recurs contact an Authorised Service Centre.

12.2 Service data

If you cannot find a solution to the problem yourself, contact your dealer or an Authorised Service Centre.

The necessary data for the service centre is on the rating plate. The rating plate is on the front frame of the appliance cavity. Do not remove the rating plate from the appliance cavity.

We recommend that you write the data here:

Model (MOD.)

Product number (PNC)

Serial number (S.N.)

13. ENERGY EFFICIENCY

13.1 Energy saving

Make sure that the appliance door is closed when the appliance operates. Do not open the appliance door too often during cooking. Keep the door gasket clean and make sure it is well fixed in its position.

Use metal cookware to improve energy saving (only when you use a non-microwave function).

When possible, do not preheat the appliance before cooking.

Keep breaks between baking as short as possible when you prepare a few dishes at one time.

Cooking with fan

When possible, use the cooking functions with fan to save energy.

Residual heat

The fan and lamp continue to operate. When you turn off the appliance, the display shows

the residual heat. You can use that heat to keep the food warm.

When the cooking duration is longer than 30 min, reduce the appliance temperature to minimum 3 - 10 min before the end of cooking. The residual heat inside the appliance will continue to cook.

Use the residual heat to warm up other dishes.

Keep food warm









Choose the lowest possible temperature setting to use residual heat and keep a meal warm. The residual heat indicator or temperature appears on the display.

Cooking with the lamp off

Turn off the lamp during cooking. Turn it on only when you need it.

14. MENU STRUCTURE

14.1 Menu

Step 1	Step 2	Step 3	Step 4	Step 5
				
 - select to enter the Menu.	Select the option from Menu structure and press OK .	Select the setting.	OK - press to confirm setting.	Adjust the value and press OK .
Turn the knob for the heating functions to the off position to exit the Menu.				
Menu structure				
Assisted Cooking 		Settings 		
Settings				
01	Time of day	Change	02	Display brightness 1 - 5

Settings

03	Key tones	1 - Beep 2 - Click 3 - Sound off	04	Buzzer volume	1 - 4
05	Uptimer	On / Off	06	Light	On / Off
07	Demo mode	Activation code: 2468	08	Software version	Check
09	Reset all settings	Yes / No			

15. ENVIRONMENTAL CONCERNS

Recycle materials with the symbol . Put the packaging in relevant containers to recycle it. Help protect the environment and human health by recycling waste of electrical and electronic appliances. Do not dispose of

appliances marked with the symbol  with the household waste. Return the product to your local recycling facility or contact your municipal office.



zanussi.com

867380122-A-052022



**UK
CA** **CE**