

Hisense

life reimagined

EN IT RO

User and Installation Manual Built-In Gas Hob

Models:

GM642XHS (JGT4-H6CFM)

GM643XHC (JGT4-H6AGM)

GM663XHF (JGT4-H6AJM)

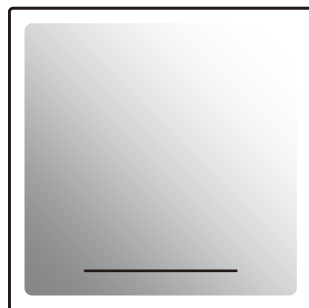

Before installing or using the appliance, please read the manual carefully, and keep it for future reference.

We thank you for your trust and the purchase of our appliance.

This detailed instruction manual is supplied to make the use of this product easier. The instructions should allow you to learn about your new appliance as quickly as possible.

Make sure you have received an undamaged appliance. If you do find transport damage, please contact the seller from which you purchased the appliance, or the regional warehouse from which it was supplied. The telephone number can be found on the invoice or on the delivery note.

Instructions for use are also available at our website:

www.gorenje.com / < <http://www.gorenje.com> />

The following symbols are used throughout the manual and they have the following meanings:

 **INFORMATION!**
Information, advice, tip, or recommendation

 **WARNING!**
Warning – general danger

 **GAS CONNECTION!**
Warning – gas connection

 **ELECTRIC SHOCK!**
Warning – danger of electric shock

 **HOT SURFACE!**
Warning – danger of hot surface

 **DANGER OF FIRE!**
Warning – danger of fire

✓ **RIGHT!**

✗ **WRONG!**



It is important that you carefully read the instructions.

Contents

Safety regulations	4
READ CAREFULLY AND KEEP FOR FUTURE REFERENCE!	4
Gas hob	7
User Manual	9
Models	9
Converting nozzles	10
GAS SECTION	12
Use	13
Control	13
Burner position	13
Cleaning	14
Faults table	14
Installation instruction	15
Safety regulations	15
Preparations for installation	18
Built-in	18
Dimensions	19
Sealing tape	19
Accessibility	19
Connecting&testing	20
Check for gas tightness and operation	20
Start up	20
Checking operation	20
Environmental considerations	21
Disposal of the appliance and packaging	21

Safety regulations



READ CAREFULLY AND KEEP FOR FUTURE REFERENCE!

General

- The manufacturer cannot be held liable for any damage resulting from failure to follow the safety instructions and warnings.
- Damage caused by incorrect connection, incorrect fitting, or incorrect use is not covered by the warranty.

WARNING!

This appliance and the accessible parts will become hot during use. Do not touch hot parts. Keep children younger than 8 away from the appliance unless they are under continuous supervision.

DANGER OF FIRE!

- WARNING: Danger of fire: do not store items on the cooking surfaces.
- CAUTION! The cooking process has to be supervised. A short term cooking process has to be supervised continuously.

DANGER OF FIRE!

WARNING: Cooking with fat or oil on a hob without supervision can be dangerous and can lead to a fire.

- NEVER try to extinguish a fire with water. Instead, switch the appliance off and then cover the flames with for example a lid or a fire blanket.
- Never flambe under a cooker hood. The high flames can cause a fire, even if the cooker hood is switched off.

WARNING!

- Use only hob guards designed by the manufacturer of the cooking appliance or indicated by the manufacturer of the appliance in the instructions for use as suitable or hob guards incorporated in the appliance. The use of inappropriate guards can cause accidents.
- The hob is only to be used for the preparation of food.
- The unit is not designed for heating rooms.
- Do not warm closed tins on the hob. There will be a build-up of pressure that will cause tins to explode. You might get injured or scalded.
- Never cover the appliance with a cloth or something similar. If the appliance is still hot or is switched on, there is a risk of fire.
- Do not use the appliance as a worktop. The appliance may accidentally be switched on or still be hot, which means objects could melt, become hot or catch fire.
- Do not use the appliance in temperatures below 5 °C.
- The appliance should not be placed or used outdoors.

- When you use the hob for the first time you will notice a “new smell”. Don't worry this is normal. If the kitchen is well ventilated, the smell will soon disappear.
- The appliance is not intended to be operated by means of an external timer or separate remote control system.
- Never open the casing of the appliance.
- Never use a pressure cleaner or steam cleaner to clean the hob.
- The ceramic top is extremely strong, but not unbreakable. For example, a spice jar or sharp utensil falling on it could cause it to break.
- If a drawer underneath the appliance is permitted (see the installation instructions), without an intermediate bottom, this should not be used to store highly flammable objects/materials. Ensure that there is adequate clearance of a few centimetres between the bottom of the hob and the contents of any drawers.

ELECTRIC SHOCK!

- **WARNING!** In case of hotplate glass breakage: Shut immediately off all burners and any electrical heating element and isolate the appliance from the power supply.
- Do not touch the appliance surface.
- Do not use the appliance.

⚠ WARNING!

- This appliance can be used by children aged 8 years and over, as well as by people with reduced physical, sensory or mental capabilities or lack of experience and knowledge, provided they are supervised and instructed in the safe use of the appliance and understand the hazards involved.
- Do not allow children to play with the appliance.
- Do not allow children to clean or maintain the appliance unless supervised.
- Do not keep objects that children might find interesting in cupboards above or behind the appliance.
- The cooking zones/burners heat up during use and stay hot for a while afterwards. Keep young children away from the hob during and immediately after cooking.

Gas hob

CAUTION!

- The use of a gas cooking appliance results in the production of heat, moisture and products of combustion in the room in which it is installed. Ensure that the kitchen is well ventilated especially when the appliance is in use. Prolonged intensive use of the appliance may require additional ventilation, for example the increasing of mechanical ventilation where present, additional ventilation to safely remove the products of combustion to outside(external) air whilst also providing room air changes with additional ventilation. Consult a professional before installation of the additional ventilation.
- The burner components are hot during and immediately after use. Do not touch them, and avoid contact with nonheat resistant materials.

- This appliance is for cooking purposes only. It shall not be used for other purposes, for example room heating.
- Never immerse hot burner caps and pan supports in cold water. The rapid cooling can damage the enamel.
- The distance between the pan and a knob or non-heat resistant wall should always be greater than one centimetre. In case of smaller distances, the high temperature may cause the knobs or wall to discolour and/or deform.
- Always use the pan supports and suitable cookware.
- Always place the pan on the pan support. Placing the pan directly on the burner cap can result in dangerous situations.
- Aluminium trays or foil are not suitable as cooking utensils.
- They can burn into the burner caps and pan supports.
- The hob can only function effectively if the burner components have been assembled using the guide ridges. Ensure that the pan supports lie properly against each other and flat on the drip tray. Only then can the pans be positioned stably.
- Keep oven gloves or oven cloths away from the flame.
- Do not use griddle plates or baking plates.
- Clean the burner parts regularly for safe and correct operation of the burners.
- Missing rubber feet from the pan supports can cause scratches on the drip tray or poor combustion of the burner. If the rubber feet are missing, please contact our service department.

User Manual

Models

- A - Auxiliary burner
- B - Semi-rapid burner
- D - Rapid burner
- E - Wok burner

GM643XHC

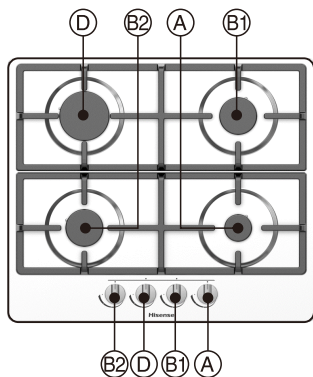

GM642XHS

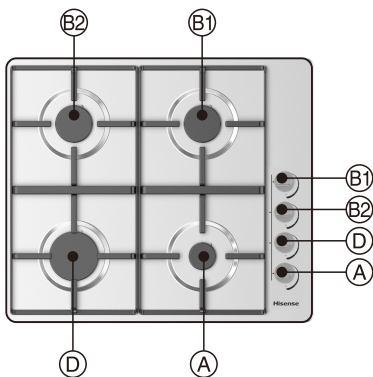



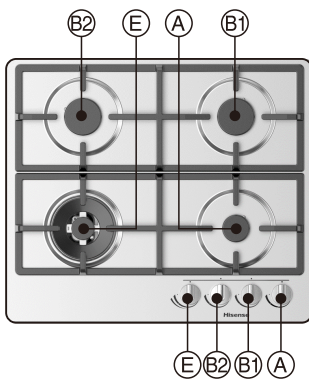

GM663XHF



Adapt the built-in gas range to the type of gas

Burners and Nozzle Specifications

I3B/P (28-30); I3+ (28-30/37) G30/31(28-30mbar)				I3B/P (37) PL G30/31(37mbar)				I2H (20); I2E (20); I2E+ (20) G20(20mbar)				I2H (25) HU G20(25mbar)			
	Burner	Thermal power (kW)	Nozzle 1/100 (mm)		Burner	Thermal power (kW)	Nozzle 1/100 (mm)		Burner	Thermal power (kW)	Nozzle 1/100 (mm)		Burner	Thermal power (kW)	Nozzle 1/100 (mm)
A	Auxiliary (small)	1.05 (76g/h)	50	A	Auxiliary (small)	1.15 (84g/h)	50	A	Auxiliary (small)	1.05	72	A	Auxiliary (small)	1.15	72
B	Semi rapid (Medium)	1.75 (127g/h)	65	B	Semi rapid (Medium)	1.9 (138g/h)	65	B	Semi rapid (Medium)	1.85	97	B	Semi rapid (Medium)	2.0	97
D	Rapid burner	3.0 (218g/h)	85	D	Rapid burner	3.4 (247g/h)	85	D	Rapid burner	3.0	128	D	Rapid burner	3.4	128
E	Wok burner	4.0 (291g/h)	100	E	Wok burner	4.4 (320g/h)	100	E	Wok burner	4.0	150	E	Wok burner	4.4	150

Information according to regulation 66/2014 Measurements according to EN60350-2				
Model identification		GM642XHS	GM643XHC	GM663XHF
Type of hob		Gas hob		Gas hob
Number of gas burners		4		4
Heating technology		Gas burner		Gas burner
Energy efficiency per gas burner (EE _{gas burner}) in %	Semi-rapid burner (2x):	58.0		58.0
	Rapid burner:	58.0		-
	Wok burner:	-		57.7
Energy efficiency for the gas hob		58.0		58.0

Converting nozzles



Additional conversion set for G30/G31 to be obtained via after sales.

NOTE!

Nozzle sets code:

3429802 (including 4 nozzles for appliances including 1x Aux, 2x Semi Rapid and 1x Rapid burner).

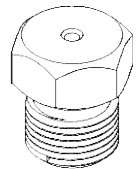

These nozzles are suitable for: I3B/P (28-30); I3+(28-30/37); I3B/P (37) PL.

Contents of conversion set

- Nozzles for burners and (if applicable) by-pass screws for gas taps.
- Data label with the modified gas specifications and setting.

Tools needed:

- T1 Socket spanner (7 mm) T2 Screwdriver flat blade (4 mm) T3 Nose pliers
T5 Leak test spray T4 Open-end spanner (7 mm)



Please note: disconnect the appliance from the power supply.

NOTE!

Prevent damage of the worktop. Lay down parts of the appliance on a protected base.

For converting to a different type of gas, the nozzles have to be changed.
The values are also marked on the nozzle.

1. Remove pan supports, burner heads, crowns and covers (see pictures A1 and A2).
Pull off the control knobs vertically.
2. Use the socket (T1) or open-end spanner (T4) to remove the old nozzles and place the new nozzles inside the burner cups (see pictures A1 and A2).

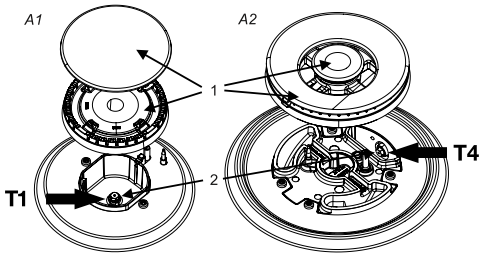

REGULATING THE BURNER MINIMUM SETTING

When switching from one type of gas to another, the minimum flow rate must also be corrected. The flame should not go out even when passing suddenly from maximum to minimum flame. To regulate the flame follow the instructions below:

1. Light the burner
2. Turn the gas valve to the minimum position

On gas valves provided with adjustment screw on the valve body:

Turn the screw "A" to the correct setting with a screwdriver. Normally for G30 gas, fully tighten the adjustment screw.

 The operations must be executed by a qualified technician.

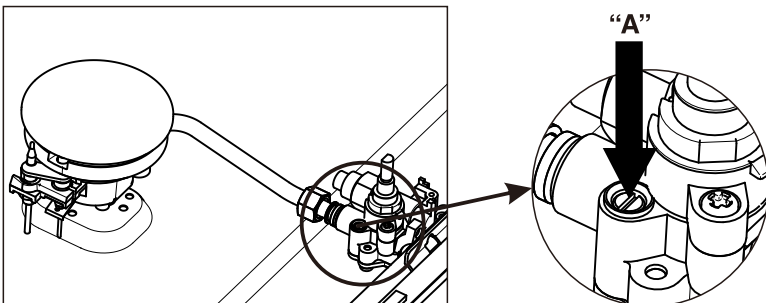

GAS SECTION

TYPES OF GASES

IMPORTANT: By default the built-in gas hob is adjusted for natural gas and comes with nozzles suitable for LPG. The appliance should be installed, regulated and adapted to function with other types of gas by a **QUALIFIED GAS INSTALLER**.

INSTALLATION

The appliance is predisposed and adjusted to operate with the gas indicated on the specifications plate applied onto the appliance.

If the appliance must be operated with a gas different than that indicated on the plate, it is necessary to execute the following operations:

- gas connection
- replacement of the injectors
- Regulation of the minimum setting

GAS CONNECTION

IMPORTANT: The connection must be executed by qualified technician according to the relevant local standard.

The connection must be executed by qualified technician according to the relevant standard. The fitting is made up of (see below figuration);

- 1 Elbow fitting "A"
- 1 Gaskets "B"
- A built in gas hob must be installed in a room with adequate ventilation.

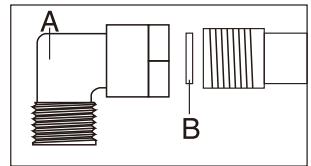

ORIENTATION of the ELBOW

The appliance is supplied with a gas connection oriented towards the centre of the built-in gas hob. The connection to the gas supply must be effected only from this side or in vertical position by turning the elbow downwards. To turn the elbow, follow these operations:

- Loosen the nut
- Turn the elbow
- Lock the nut
- Make sure that there are no Leakage by a soapy solution.

-  Before using the appliance, make sure there is no leakage at each connection. You can use the soapy water to check each connection. In the case of leakage, turn off the gas supply immediately. Keep it away from any flammable source and tighten the connection again.

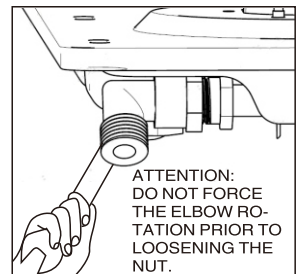

Use

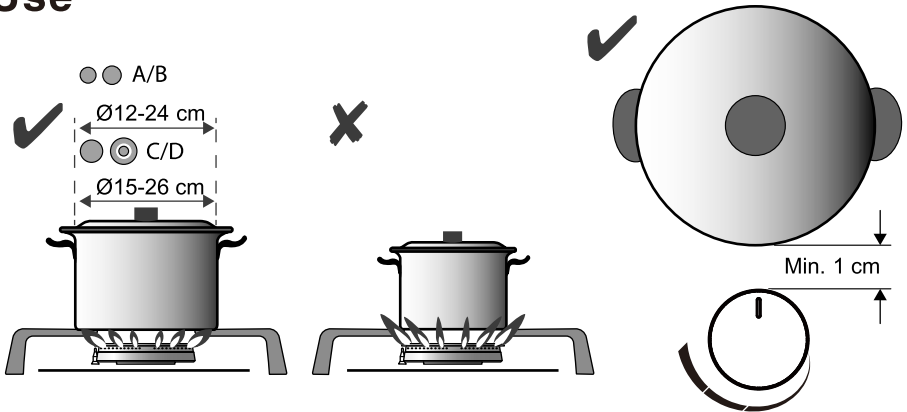

⚠ WARNING! The distance between the pan and a non-heat resistant wall should always be greater than one centimetre. In case of smaller distances, the high temperature may cause the knobs or wall to discolour and/or deform.

Warning! Do not use cooking vessels on the hob that overlap its edges.

Control

(1) Push (2) Turn left+hold (3) Hold down 3 sec.

If the ignition is unsuccessful, turn the knob back to the closed position wait for 5s and then press 1~3 steps again to ignite. If you still cannot fire, please refer to the fault table below.

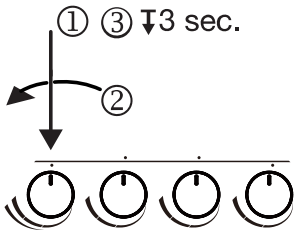

high setting

Low setting

Close setting



Warning: In the event of the burner flames being accidentally extinguished, turn off the burner control and do not attempt to re-ignite the burner for at least 1 min.

Burner position

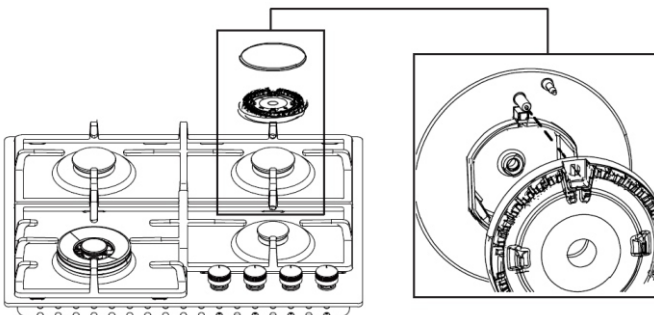

Cleaning

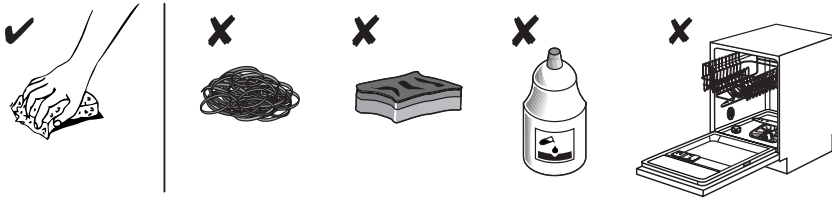

Faults table

Following is some advice on rectifying some common problems.

What happened...?	Possible cause	What to do?
The burners will not burn. The flame is uneven/unstable.	The flame is uneven due to a wrong gas power setting.	Have an expert check the gas pipeline!
The flame from the burners suddenly changes.	Wrongly assembled parts of the kitchen hob.	Assemble the burner correctly.
Burner ignition takes more time.	Wrongly assembled parts of the kitchen hob.	Assemble the burner correctly.
The flame is extinguished shortly after ignition.	Knob pressed too short or too weakly.	Keep the knob pressed for a longer period of time.
The grid has discoloured in the burner area?	This is a commonplace phenomenon resulting from high temperature.	Clean the grid with a metal care detergent.
Electric power supply, in general, is interrupted?	The fuse may be blown.	Check the fuse in the fuse box and replace it if it is blown.
Burner still light back	The burner cap is not in corrective position.	In the event of burn-back, turn the knob to the close position. After the appliance cools down, adjust the burner cap and make sure it is in corrective position. If the burner still light back, ask the qualified person for help. Do not modify the appliance by yourself.
Electric ignition of the burners no longer works?	There are food or detergent residues between the spark plug and the burner.	Open and carefully clean the opening between the spark plug and the burner.
The burner cover looks unappealing.	Regular dirt.	Clean the burner covers with a metal care detergent.

A visit by a service technician during the warranty period will be charged if the appliance is not functioning because of improper use. Store these instructions in a place where they are always readily accessible; if you pass the appliance on to another person, the instructions should also be included.

NOTE!

If the problem persists despite observing the instructions above, call an authorized service technician. Elimination of any errors or warranty claims that resulted from an improper connection or use of the appliance is not covered by our warranty. In such cases, the costs of repair are borne by the user.

Installation instruction



Safety regulations

- This appliance shall be installed in accordance with the regulations in force and only used in a well-ventilated space. Read the instructions before installing or using this appliance.

WARNING

The adjustment conditions for this appliance are stated on the label(or data plate).

this appliance is not connected to a combustion products evacuation device. It shall be installed and connected in accordance with current installation regulations.

Particular attention shall be given to the relevant requirements regarding ventilation.

- This appliance should only be connected by a registered installer.
- Prior to installation, ensure that the local distribution conditions (voltage, frequency, nature of the gas and gas pressure) and the adjustment of the appliance are compatible.
- This appliance must be earthed.
- The voltage, frequency, power, type of gas and the country for which the appliance has been designed are shown on the appliance rating plate.



- Electrical connection Class I - 220-240V ~ 50/60 Hz - max 1 W.

- The electrical connection must comply with national and local regulations.

- The wall plug socket and plug should always be accessible.

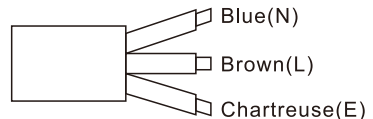

Please wire according to the correct wiring harness

- If a stationary appliance is not fitted with a supply cord and a plug, or with other means for disconnection from the supply mains having a contact separation in all poles that provide full disconnection under overvoltage category III conditions, the means for disconnection must be incorporated in the fixed wiring in accordance with the wiring rules. Using an omnipolar switch with a contact separation of at least 3 mm fitted in the supply cable will fulfil this requirement.
- The connection cable must hang freely and should not be fed through a drawer.



- Gas connection 1/2" ISO 228 / ISO 7-1 / EN 10226-1 (1/2" ISO 228 / 1/2" ISO 228 FR only).

The gas connection must comply with national and local regulations. See appliance label for technical gas data.

- This appliance is not connected to a combustion products evacuation device. It shall be installed and connected in accordance with current installation regulations. Particular attention shall be given to the relevant requirements regarding ventilation.
- We recommend that the gas hob be connected by means of a fixed pipe. Connection using a specially designed safety hose is also permitted.
- The pipe behind the oven must be made entirely out of metal.
- A safety hose may not be bent and must not come into contact with moving parts of kitchen units.

- The gas supply valve must always be placed in an easily accessible position.
- The work top into which the hob is fitted should be flat.
- The walls and the work top surrounding the appliance must be heat resistant up to at least 105°C.

Service

- Faulty parts may only be replaced by original parts.
- The manufacturer can only guarantee that original parts meet safety requirements.
- If the supply cord is damaged, it must be replaced by the manufacturer, its service agent or similarly qualified persons in order to avoid a hazard.

Preparations for installation

Free space around the appliance

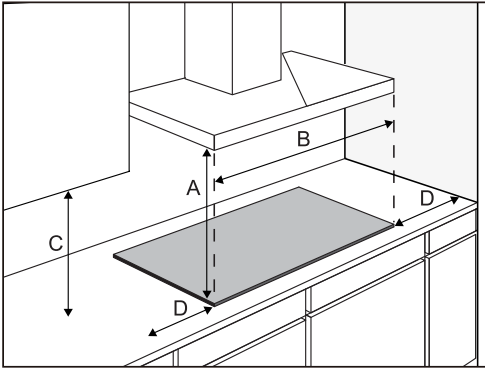

A(mm)	min.650
B(mm)	min.600
C(mm)	min.450
D(mm)	min.120

Built-in

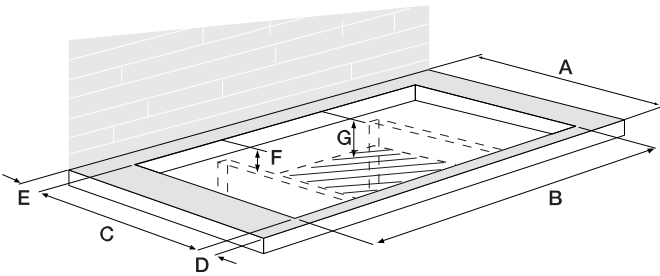

A(mm)	B(mm)	C(mm)	D(mm)	E(>mm)	F(mm)	G(mm)
600	560	490	60	50	50	100

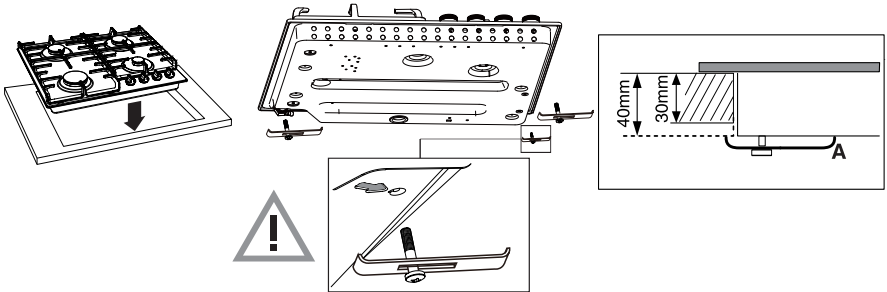

Dimensions

Appliance:

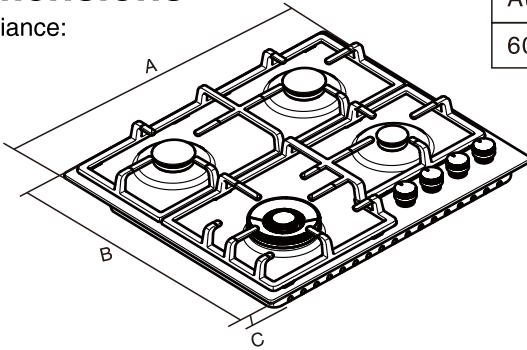

A(mm)	B(mm)	C(mm)
600	520	40

Sealing tape

Stainless steel drip tray

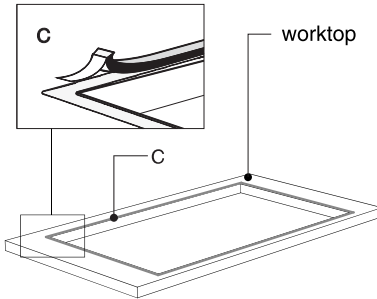

Glass drip tray

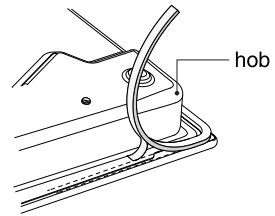

Accessibility

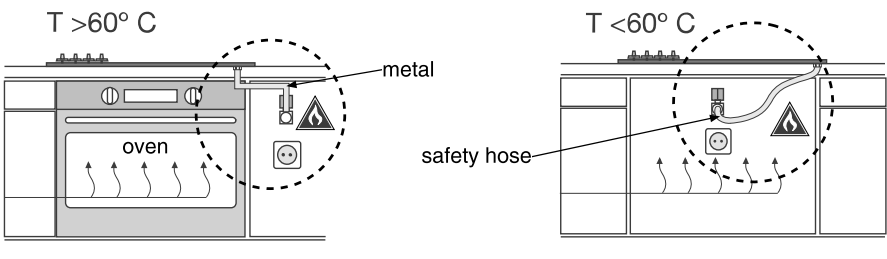
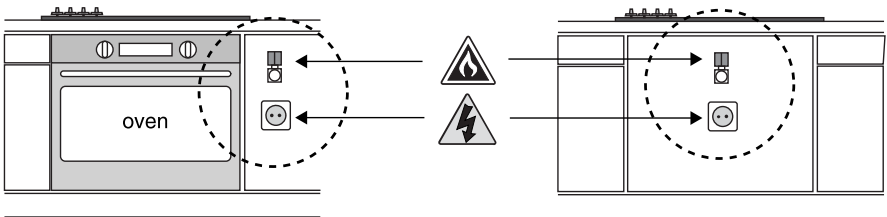

Connecting & testing

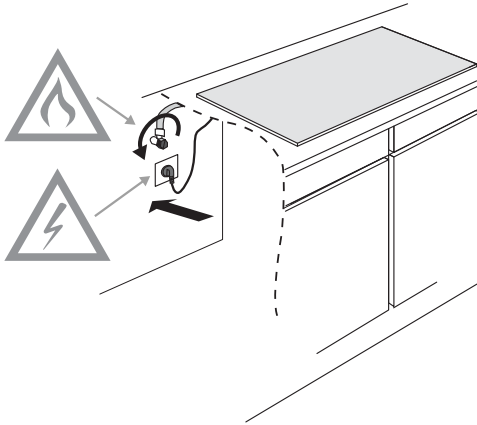

! WARNING!
Check if connections are gastight.

Check for gas tightness and operation

When the appliance is connected to the gas supply, use leak test spray to check the gas tightness.

1. Seal the injector.
2. Open the gas tap. Attention: press and open tap to override the thermo-electric safety device and keep it pressed down.
3. Spray leak test spray over all gas connections and check for gas tightness.
4. Repeat for every burner.

Start up

1. Reinstall the knobs, burner parts and pan supports.
2. Check if the appliance is connected to the correct gas type and pressure.
3. Open the main gas valve.
4. Insert the plug into the power socket.

Checking operation

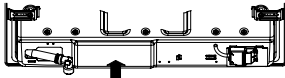

ADJUSTED FOR EINGESTELLT AUF 3 ПОДПРАВКОВО НА PRILAGODEN ZA PO OCISTENI O PRILAGODEN ZA AJUSTATE PENTRU	SKORYGOWANE O KORRIGALT НАСТРОЕНО ДЛЯ КЕРТЕЦІ УСИХ ТЕПШЕРЕН	c1
GXX XX mbar		

1. Ignite the burners.
2. Check whether the flame profile is normal, uniform and stable for the complete ratio:
3. • Check if the flame does not smother in simmer rate;
• Check if the flames are not 'blowing off' at maximum rate;
• No long, yellow flames should be visible during operation.
4. Paste the data label with the modified gas specifications and setting over the current data label with old specification (at the underside of the appliances nearby the gas connection).

Environmental considerations

Disposal of the appliance and packaging

Sustainable materials have been used during the manufacture of this appliance.

The appliance packaging is recyclable. The following may have been used:

- cardboard;
- paper;
- polyethylene film (PE);
- CFC-free polystyrene (PS-rigid foam);
- polypropylene tape (PP).

Dispose of these materials in a responsible manner and in accordance with government regulations.

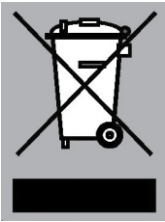

To designate the requirement for separate collection of household electrical appliances, the symbol of a crossed-out dustbin is applied to the product. This means that at the end of its working life, the product must not be disposed of as urban waste. It must be taken to a special local authority differentiated waste collection centre or to a dealer providing this service. Disposing of a household appliance such as this hob separately avoids possible negative consequences for the environment and health and enables the constituent materials to be recovered, resulting in significant savings in energy and resources.

NOTE!

Please note! Do not throw a broken ceramic glass plate in the glass recycling bin but take this to the Municipality's waste recycling centre.

Declaration of conformity



Pin code:2531DO-0065

We hereby declare that our products satisfy the applicable European directives, orders and regulations, as well as the requirements stated in the referenced standards.

Hisense