

Tall Wide Extra Deep Bookcase

Assembly Instructions - Please keep for future reference

609/2139

609/3554

609/4687

609/5758

609/5772

610/9534

317/8575

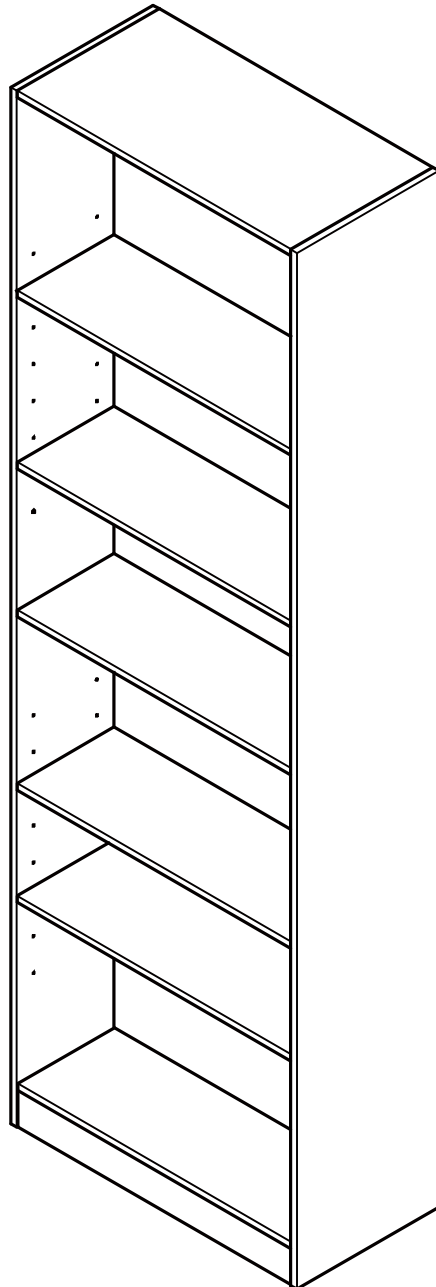

Dimensions

Width - 78cm

Depth - 29cm

Height - 180cm

Important - Please read these instructions fully before starting assembly

If you need help or have damaged or missing parts, call the **Customer Helpline:**
Argos = 0345 6400800



Safety and Care Advice

Important – Please read these instructions fully before starting assembly

- Check you have all the components and tools listed on the following pages.
- Remove all fittings from the plastic bags and separate them into their groups.
- Keep children and animals away from the work area, small parts could choke if swallowed.
- Make sure you have enough space to layout the parts before starting.

- During assembly do not stand or put weight on the product, this could cause damage.
- Assemble the item as close to its final position (in the same room) as possible.
- Assemble on a soft level surface to avoid damaging the unit or your floor.
- Parts of the assembly will be easier with 2 people.



- To reduce the likelihood of damaging your product please ensure that your power drill is set on a low torque setting.

Care and maintenance

- Only clean using a damp cloth and mild detergent, do not use bleach or abrasive cleaners.
- From time to time check that there are no loose screws on this unit.
- This product should not be discarded with household waste. Take to your local authority waste disposal centre.

Handy Hints

- Assemble all parts and bolts loosely during assembly, only once the product is complete should you fully tighten the bolts
- Regularly check and ensure that all bolts and fittings are tightened properly.

Components - Panels

If you have damaged or missing components, call the
Customer Helpline: Argos = 0345 6400800

Please check you have all the panels listed below



1 Fixed panel x 2 (74.9 x 28.4cm)

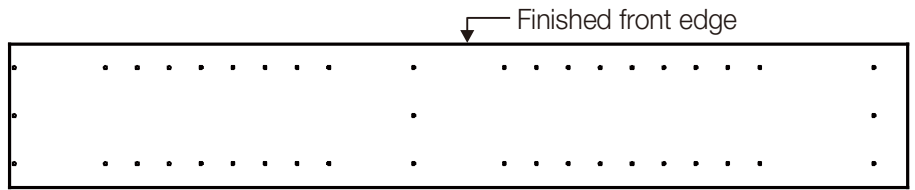

5 Right side panel (180 x 28.6cm)

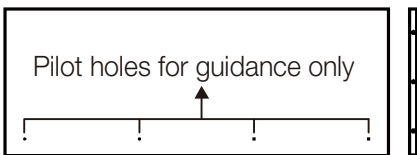

2 Bottom panel
(74.9 x 28.4cm)

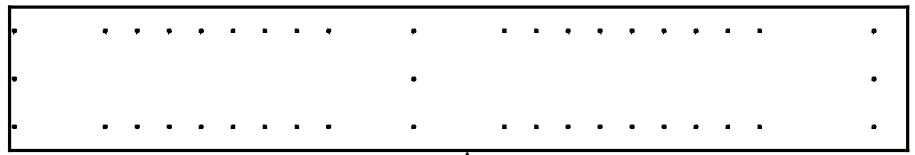

6 Left side panel (180 x 28.6cm)



3 Shelf x 4 (74.9 x 28.4cm)

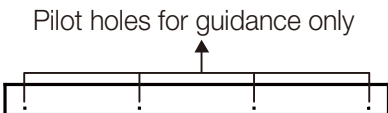

4 Front panel
(74.9 x 5.9cm)

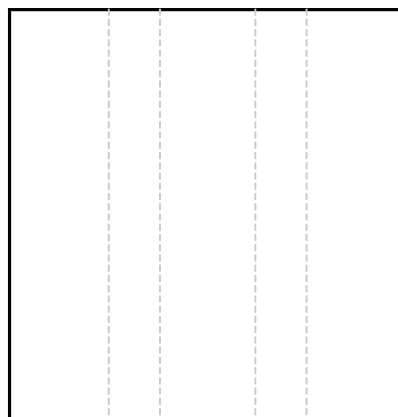

7 Top back panel
(76.7 x 79.8cm)

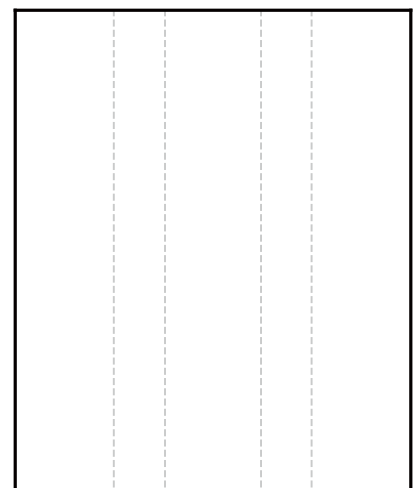











8 Bottom back panel
(76.7 x 93.6cm)

Components - Fittings

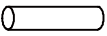
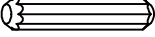
Please check you have all the fittings listed below

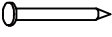
Note: The quantities below are the correct amount to complete the assembly. in some cases more fittings may be supplied than are required.

A  Plastic support x 4	B  14mm Screw x 9	C  Wall strap x 1 (This screw is included in the bag of wall strap)  x 1
D  50mm Screw x 12	E  Support cover x 16	F  Shelf support x 16
G  30mm Dowel x 6	H  Screw cover x 12	I  Nail x 46
J  Wall plug x 1		

Tools required



Phillips screwdriver
(medium & large)



7mm Suitable drill bit
(for use with wall plug)

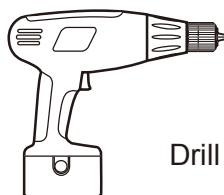

Drill



Small
hammer



Ruler/tape
measure



Eye protection
(when using a
hammer or glue)

Ruler - Use this ruler to help correctly identify the screws

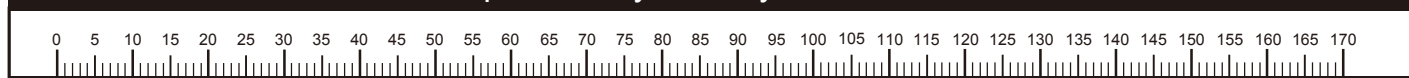

The screws length is measured from the head to the point (30mm screw shown).

Assembly Instructions

Step 1

Attaching bottom panel

a: Use Plastic supports **A** and Screws **B** to fix the Front panel **4** onto the Bottom panel **2**.

b: Then insert Dowels **G** into the Bottom panel **2** and Fixed panels **1**.



Caution: Always check the assembly method is correct before applying glue.

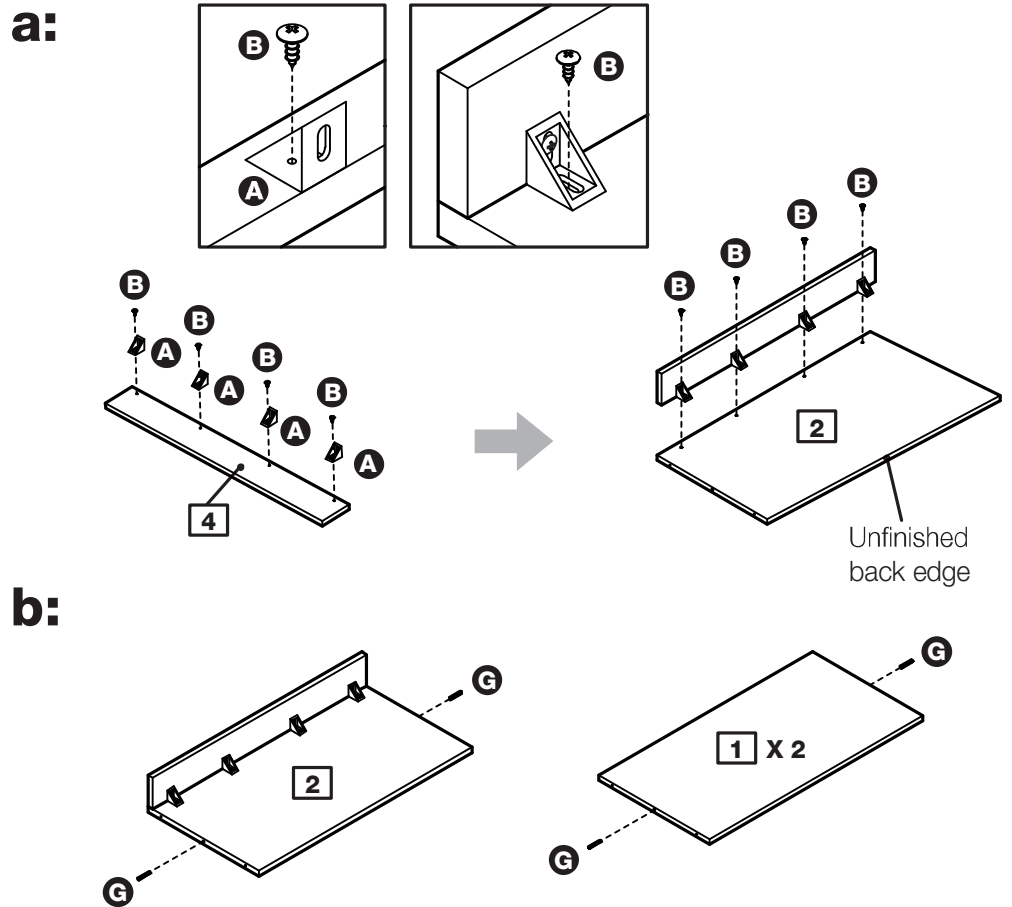

Step 2

Attaching side panels

Use Screws **D** to fix the Left Side panel **6** and Right side panel **5** onto the Bottom panel **2** and Fixed panels **1**.

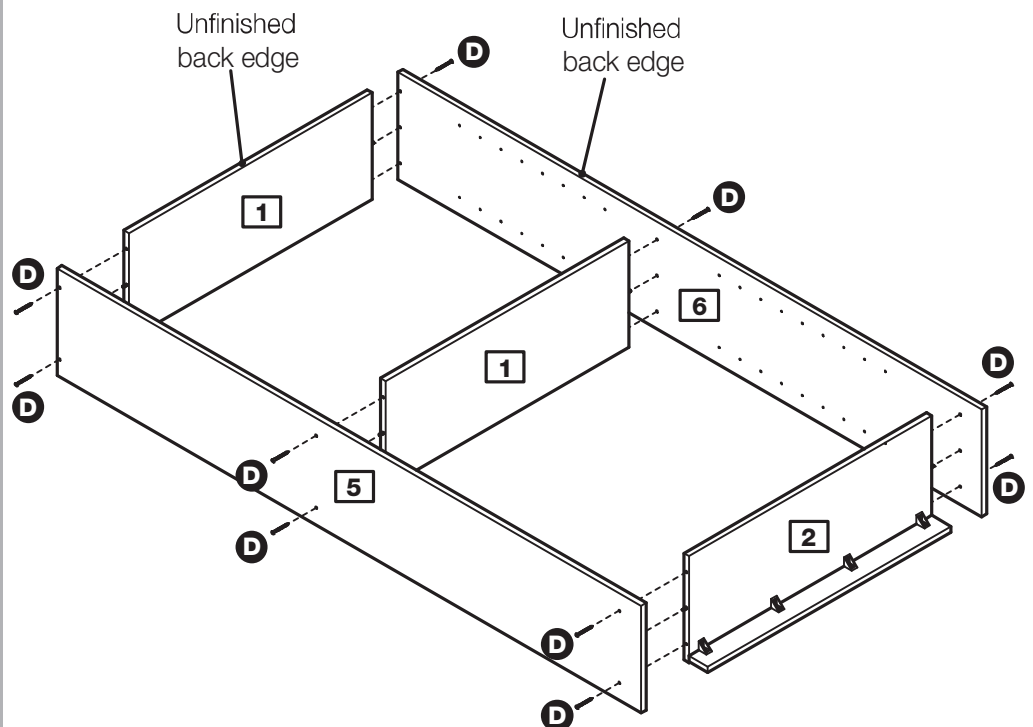

Assembly Instructions

Step 3

Fixing back panels

Attach Top back panel **7** and Bottom back panel **8** onto the unit using Nails **1**.



Important:
The unit **MUST**
be 'square' when
back is attached.

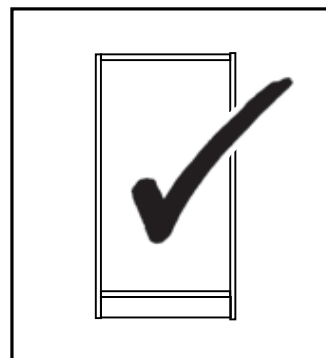
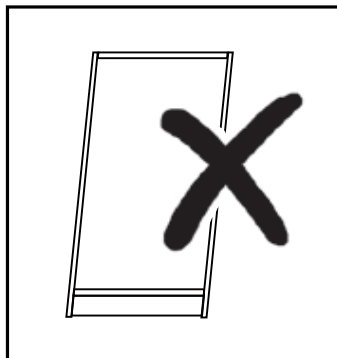
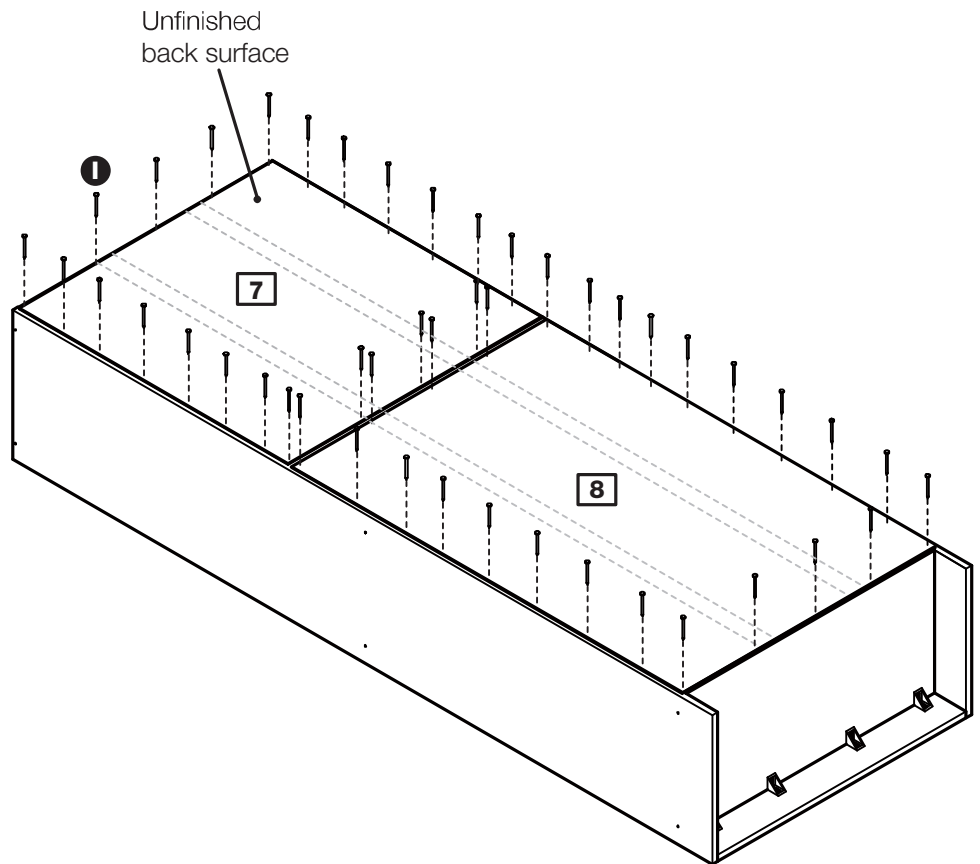

Assembly Instructions

Step 4

Attaching shelves

With help, carefully stand bookcase upright.



Warning:

The bookcase is heavy.
Lift with care.

a: Slide Support covers **E** onto Shelf supports **F**.

Insert Shelf supports **F** (Support covers **E** are included) into the unit. Ensure they are well fitted before inserting the Shelves.

Note: Set the shelf supports to the desired height.

Use Screw covers **H** to cover the screw heads.

a:

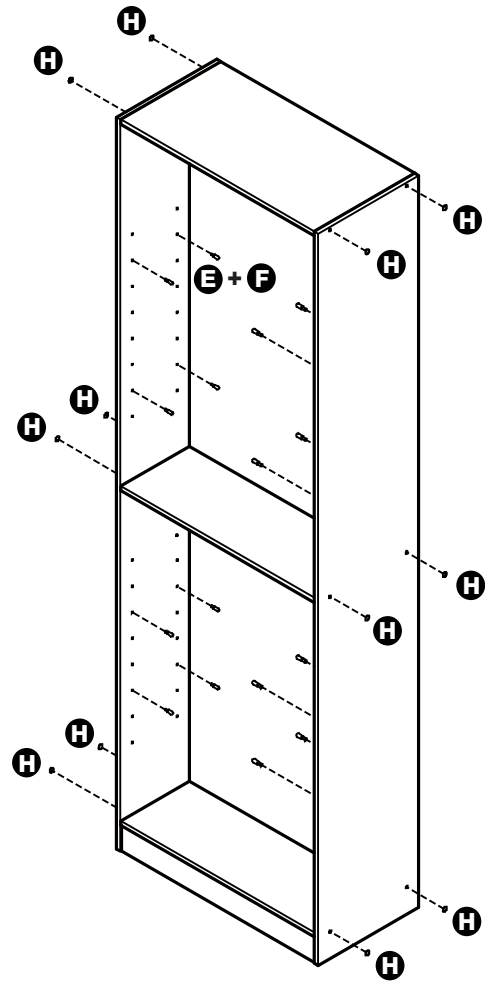
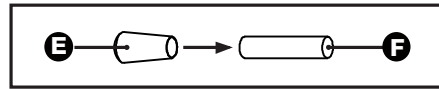

b: Slide the Shelves **3** into the unit.

b:

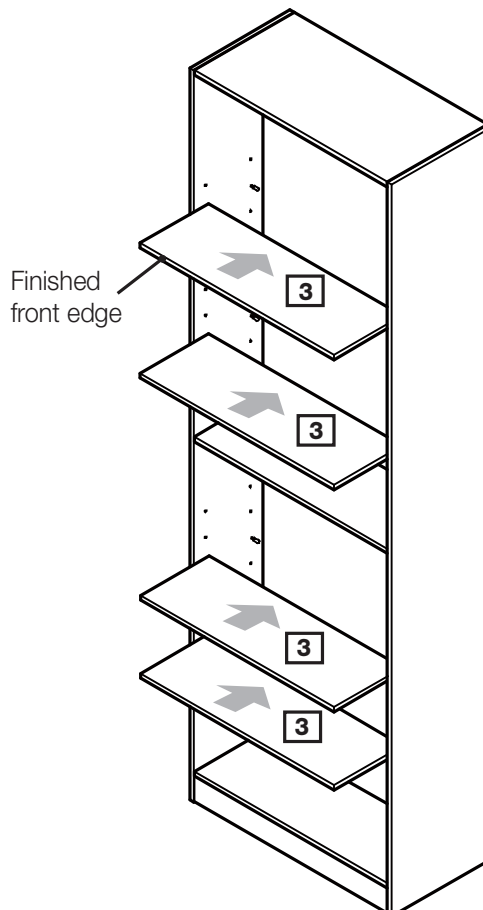

Assembly Instructions

Step 5

Fixing to wall

It is recommended that the bookcase is fixed to a wall.

Fix Wall strap **C** to top panel using Screw **B**.

With help, move bookcase into position.



Warning:

The bookcase is heavy.

Lift with care.

Mark fixing hole on wall and remove bookcase .

Drill a hole and insert Wall plug **J**.



Warning:

Before drilling, check wall for hidden pipes and cables.

Reposition bookcase and fix wall strap using Screw **C**.

Assembly is complete.

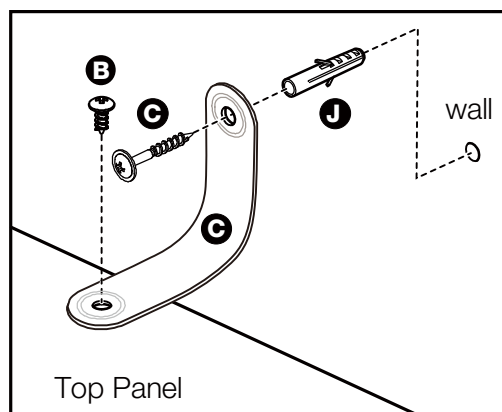

Note: Wall plugs supplied are for solid wall only.

The correct type of fixing must be used for your wall, seek professional advice if in doubt

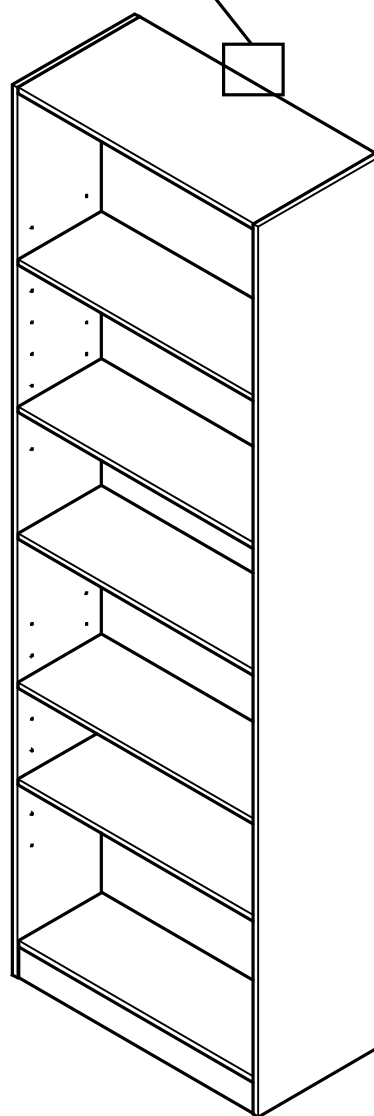
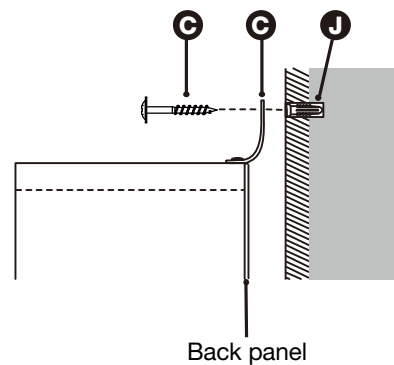

If you need help or have damaged or missing parts, call the **Customer Helpline:**
Argos = 0345 6400800

A Guide to - Wall Mounting & Fixings

Important note:

If plastic wall plugs are supplied with your product:



- these are only suitable for use in masonry walls.

If you are in any doubt about the correct wall plugs for your wall, seek professional advice.

Failure of the product due to using incorrect fixings is the responsibility of the installer.



Important: When drilling into walls always check that there are no hidden wires or pipes etc.

Make sure that the screws and wall plugs being used are suitable for supporting your unit. Consult a qualified tradesperson if you are unsure.

Hints:

- 1: General rule:**  Always use a larger screw and wall plug if you are not sure.
- 2:** Ensure you use the recommended drill bit to match the wall plug and hole size.
- 3:** Ensure you drill the hole horizontally, do not force the drill or enlarge the hole.
- 4:** Take extra care when drilling high walls, ceilings and ceramic tiles. Ensure wall plugs are inserted beyond the thickness of the ceramic tiles to avoid the tiles splitting or cracking.
- 5:** Ensure wall plugs are well fitted and are a tight fit in the drilled hole.

Types of walls

You can use one of the following types of wall plug if your walls are made of brick, breeze block, concrete, stone or wood.

No.1 "General Purpose" wall plug

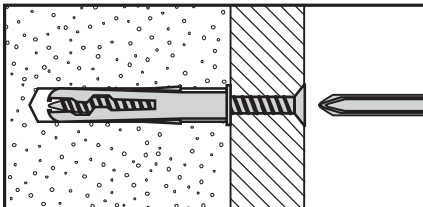

Generally aerated blocks should not be used to support heavy loads, use a specialist fitting in this case. For light loads, general purpose wall plugs can be used.

No.2 "Plasterboard" wall plug

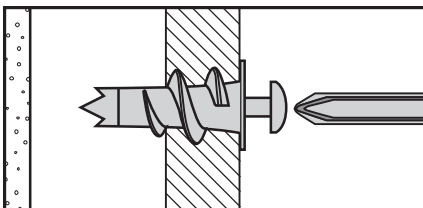

For use when attaching light loads on to plasterboard partitions.

No.3 "Cavity Fixing" wall plug

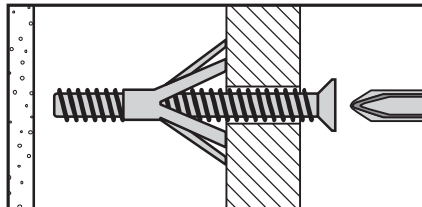

For use with plasterboard partitions or hollow wooden doors.

No.4 "Cavity Fixing-Heavy Duty" wall plug

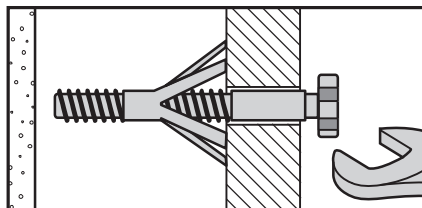

For use when fitting or supporting heavy loads such as shelving, wall cabinets and coat racks.

No.5 "Hammer Fixing" wall plug

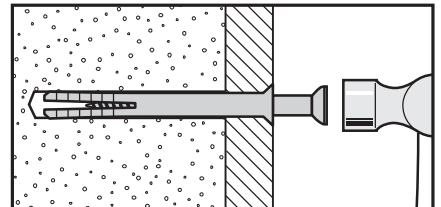

For use with walls stuck with plasterboard. The hammer fixing allows it to be fixed to the wall rather than the plasterboard. Always check the fixing is secure to the retaining wall.

No.6 "Shield Anchor" wall plug Heavy loads

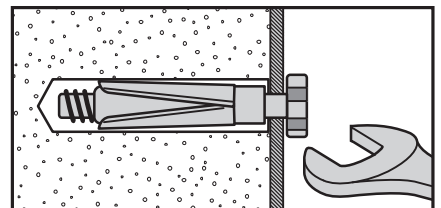

For use with heavier loads such as TV & HiFi speakers and satellite dishes etc.



Care & Maintenance

Safety: Always check the fitting and location to ensure your safety in and around the home.

Fitting: From time to time check the fitting to ensure the wall plugs or screws do not become loose.