



Technical specification

Product title	CUGGL ISIZE ROTATING CAR SEAT
Argos Cat. No.	4524692
Supplier Ref. No.	98515
Height group	40cm - 150cm
Safety compliance	Car seat complies with ECE R129
Product weight	14.5kg
Product unfolded size	L44 x W53 x H81cm

**If you encounter any problems
with this product please call
our customer care team on
0345 640 2020**

Made in China,
Argos Limited London , EC1N 2HT
Argos (N.I.) Ltd, Forestside Shopping Centre,
Upper Galwally, Belfast, United Kingdom, BT8 6FX

Cat No: 4524692

-27-



CUGGL ISIZE ROTATING CAR SEAT

For infants of height ranges from 40cm to 150cm
care & instruction manual

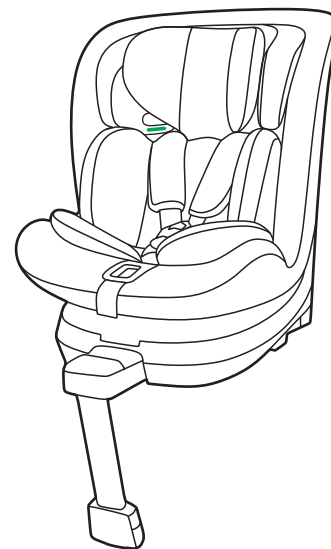

**IMPORTANT, RETAIN FOR FUTURE
REFERENCE: READ CAREFULLY**



IMPORTANT, RETAIN FOR FUTURE REFERENCE: READ CAREFULLY

This is an i-Size Child Restraint System. It is approved according to UN Regulation No.129, for use in i-Size compatible vehicle seating positions as indicated by vehicle manufacturers in the vehicle

This is an i-Size booster seat Enhanced Restraint System. It is approved according to UN Regulation No.129, for use in i-Size compatible vehicle seating positions as indicated by vehicle manufacturers in the vehicle users' manual.

If in doubt, consult either the Enhanced Child Restraint System manufacturer or the retailer.

Do not use the ECRS in seating positions where there is an active frontal airbag installed.

IMPORTANT

DO NOT USE FORWARD FACING BEFORE THE CHILD'S AGE EXCEEDS 15 MONTHS (refer to instructions)

Only suitable for use in the vehicles fitted with 3 point belt which is approved to ECE Regulation No. 16.

Do not use them in seating positions where there is an active airbag installed.

Cat No: 4524692

-2-



⚠WARNING

- Read this instruction manual carefully.
- The correct fitting of the ISOFIX and support leg anchoring systems is of vital importance for the safety of your child.
- For the future use of the seat, it is important that you keep the instruction manual carefully. There is an instruction storage on the back of the seat where the instruction can be retained with the child restraint.
- Never leave your child unattended in the car.
- Do not use a child safety seat if the vehicle seat is equipped with a front airbag. This can be dangerous. This does not apply to side airbags.

IMPORTANT

- Before use our product, please read the instruction manual carefully, the product is a safety product and is only safe when used in accordance with the instruction manual.
- The product must only be used on a forward facing seat that is fitted with the ISOFIX and support leg anchoring systems.
- The product may be used on either the front or the back seat. However, we recommend that it is fitted on the back seat.
- The product has been approved according to the strictest European safety standards (R129/03) and is for stature 40-105cm (child mass limit 18kg), Rearward facing, ISOFIX+ Support Leg + Harness and is for stature 76-105cm (child mass limit 18kg), Forward facing, ISOFIX + Support Leg + Harness and is for stature 100-150cm, Forward facing, ISOFIX attachment + vehicle 3 point belt and is for 100-150cm, Forward facing Vehicle 3 point belt.
- After an accident the seat may become unsafe due to damage that is not noticeable immediately. It should therefore be replaced.
- The safety of the seat can only be guaranteed by the manufacturer if it is issued by the original owner.
- We advise you strongly that not to use a second-hand product, because you can not be sure if it is in good condition.
- The harness pads and crotch pad are important for the safety of your child, therefore use them for stature 40-105cm.
- Ensure that all luggage and objects likely to cause injury in the event of an accident are properly secured.

Cat No: 4524692

-3-



- Do not use this child seat in passenger seats are equipped with airbags.
- It is recommended that the car seats should not be used more than 5 years from the date of production. The properties of the products may deteriorate due to, for example, ageing of the plastic and this may not be visible.
- The baby car seat must not be used without the cover. Please use an original cover, as the cover contributes to the safety of the seat.
- The seat must be secured with a seat belt or ISOFIX and support leg, even when it not on use. An unsecured seat may injure other passengers in the care in an urgent stop.
- The rigid items and plastic parts of a child restraint must be located and installed that they are not liable, during everyday use of vehicle, to become trapped by a movable seat or in door of the vehicle.
- Ensure that the seat is not damaged by heavy luggage, adjustable seats or slamming the car door etc.
- No alterations may be made to the product as this could affect part or the overall safety of the seat.
- In hot weather the plastic and metal parts of the product will be hot. You should cover the seat when the car parked under the sun.
- In order to prevent damage to the cover, do not remove the product's logo. Before the purchase, please check that the seat is properly secured in your car.
- Take a short break in long journey. So that your child has some time for the relaxation.
- Set a good example yourself and always wear your seat belts.
- Tell your child that he/she should never play with the harness buckle.
- Any straps holding the restraint to the vehicle should be tight, that any straps restraining the child should be adjusted to the child's body, and that straps should not be twisted.
- Ensuring that any lap strap is worn low down, so the pelvis is firmly engaged. This product can not be used any more when it has been subject to violent stresses in an accident.
- Children can not be left in the product unattended.

WARNING: Check harnesses or restraint systems regularly for food or dirt ingress as debris or trapped foods can stop the harness / restraint system from working and could lead to a critical safety issue.

Cat No: 4524692



Know your car seat

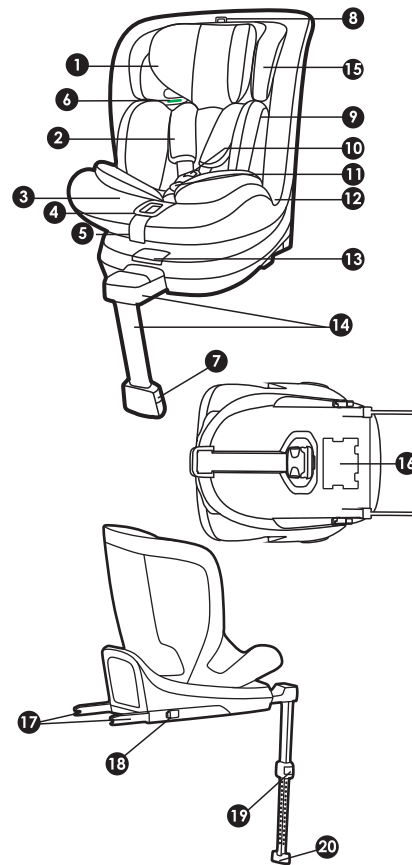

1. Headrest
2. Shoulder pads
3. Shoulder strap
4. Harness adjusting button
5. Harness adjusting strap
6. Belt guide
7. Support leg indicator
8. Headrest adjusting loop
9. Inner cushion
10. Harness buckle
11. Crotch pad
12. Base
13. Rotating button
14. Support Leg
15. Head cushion
16. Instruction storage
17. ISOFIX connector
18. ISOFIX release button
19. Support leg adjusting button
20. Support leg block

Cat No: 4524692



Use in the vehicle

Product description

	Child height	Facing direction	Installation	Approval type
Cuggl iSize Spin Car seat	40cm to 105cm	Rearward	ISOFIX + Support Leg + Harness	i-Size
	76cm to 105cm	Forward	ISOFIX + Support Leg + Harness	
	100cm to 150cm	Forward	Vehicle 3 point belt + ISOFIX attachment Vehicle 3 point belt	i-Size Booster seat

Use in the vehicle

⚠ WARNING

Never use this child restraint system in seating positions where an active airbag is installed. An active frontal airbag may cause death or seriously injure your child in an accident. Please read the instructions carefully and keep safely for future reference. There is an instructions compartment in the back of the child car seat or storage of the instructions manual.

You can use your child car seat as follows:



On front passenger seat

⚠ Yes

Only if there's no airbag or it is turned off! There must be an ISOFIX system. (Slide the seat back and refer to vehicle instructions).

Cat No: 4524692



⚠ WARNING

Never use the child car seat without its fabric cover. The fabric cover should not be replaced with any other than the ones recommended by the manufacturer. The fabric cover will affect the integral performance of the baby/child restraint system. Never try any other force points than those indicated, the main force points of this product are the ISOFIX adapter and the Top Tether.

Securing your baby Using the baby insert

CAUTION

If your baby's height is <75cm, please install the Inner cushion on the baby car seat.
If your baby's height is 75 < x <150cm. Please take out the Inner cushion from the baby car seat.



Inner cushion

- Always secure your baby in the car seat using the harness or belts.
- Never leave your baby unattended in the car seat when placing it on elevated surfaces (e.g. a table, nappy changing unit, e.t.c)
- Never allow the strap end to become caught in moving parts (e.g. automatic doors, escalators, etc.).
- Caution! The plastic parts of the car seat heat up in the sun, so that your baby may get burnt.
- Protect your baby and the car seat against intensive solar radiation (e.g. by putting a light cloth over the seat).
- Take your baby out of the car seat as often as possible to relieve its spine. We recommend frequent breaks during long journeys. Even outside of the car, please avoid leaving your baby in the car seat for too long.

Cat No: 4524692



Adjusting harness system & headrest

- 1** Loosen the shoulder straps by pressing the harness adjusting button and pull the shoulder straps as far forward as possible.

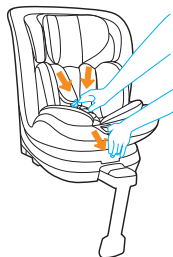

- 2** Pull the headrest adjusting loop to adjust the headrest upwards, pull the headrest adjusting loop and push the headrest back to slide the headrest downwards.

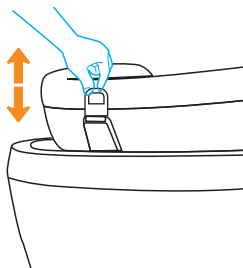

Before installing the car seat into your vehicle, please move the headrest to the correct height for your baby/child and check that it is properly engaged by lightly sliding the headrest down.

There are 12 adjustable headrest positions. Please adjust the headrest height close to your baby/child's shoulder position, if at the middle of two positions, please use the higher position.

Cat No: 4524692



Change the reclining positions

- 1** There are 5 recline positions of this product. To change the position, grasp the lever at the front of the seat, push or pull the seat into the desired position until you hear an audible "click" sound.

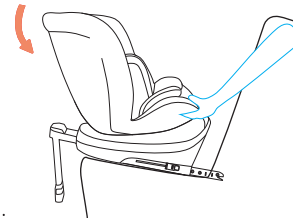

Rearward facing

For use with child's height 40-105cm.

- 2 Forward facing**
The reclining positions can be adjusted for forward facing use with a child's height of 76-105cm. The reclining position 4 & 5 do not apply for all vehicles.

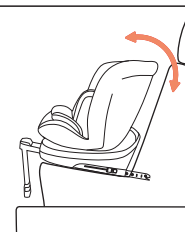

- 3 Forward facing**
If the child is between 100 and 150 cm tall and is secured by a three-point harness, it should only be used in an upright position. When the arrow label is aligned with the mounting label position (1), the seat is in an upright position.

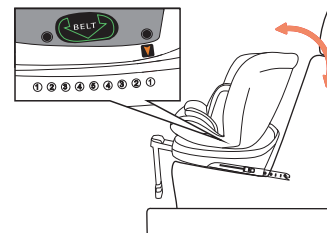

Cat No: 4524692



Support leg

1 Opening the support leg

First, remove the supporting leg from the bottom of the seat. When the supporting leg is rotated outwards 45°, the supporting leg

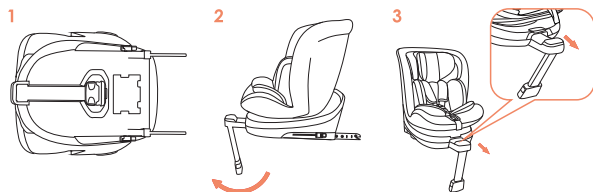

CAUTION

The seat can only be rotated when the supporting leg assembly is extended.

2 Retracting the support leg

Rotate the support leg backward to 45° and push the support leg assembly inward until it is fully in place. Finally tuck the support leg into the slot at the bottom of the seat. assembly can be pulled out.

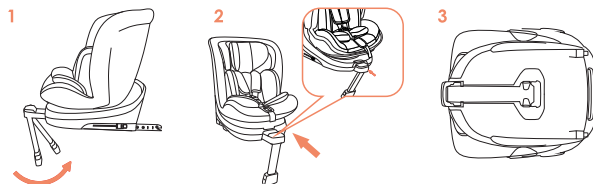

Cat No: 4524692



Installation in the vehicle

Installation instruction for child's height 40-105cm, Rearward facing, ISOFIX + Support Leg + Harness

- 1 Unfold the support leg until it locks in place. Press the ISOFIX release button to slide the ISOFIX connectors to the end.

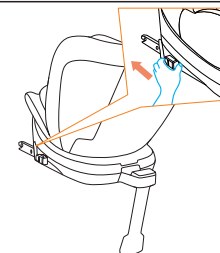

- 2 **Caution:** Please only move to the next step when the ISOFIX has been slid to the end with the red indicators showing.

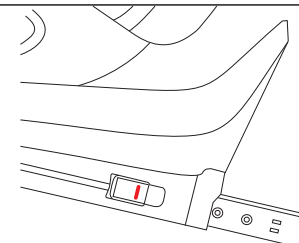

- 3 Push the ISOFIX connectors directly into the anchorages until you hear a "click" sound.

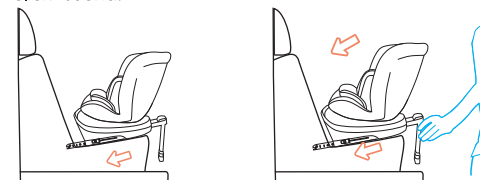

Cat No: 4524692

- 4** Grasp the seat base to check the seat is fastened tightly or shakes, meanwhile observe the ISOFIX red/green indicator. If the seat shakes and the ISOFIX connectors are pulled out, please repeat the above steps and install it again.

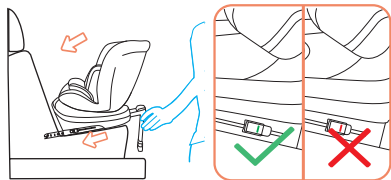

- 5** Squeeze the support leg adjusting button, pull out the support leg until it rests firmly on the floor. Observe the ISOFIX red/green indicator to confirm the installation status.

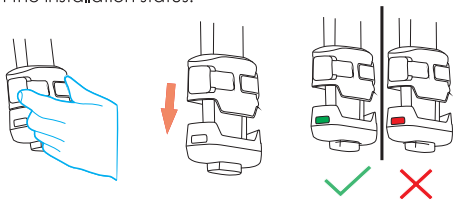

- 6** Press the rotating button, adjust the seat to sideward facing position allow access for placing a child from the seat unit after the car seat is fitted.

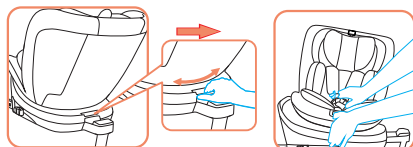

Cat No: 4524692

CAUTION

Before every journey, make sure that the rotating part has been fully engaged.
Do not drive unless the seat is in the forward or rearward facing position.

- 7** Loosen the shoulder straps by pressing the harness adjusting button and pull the harness shoulder as far forward as possible.

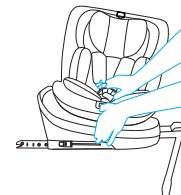

- 8** Open the buckle by pressing the red button, then fix the shoulder straps at the sides of the car seat.

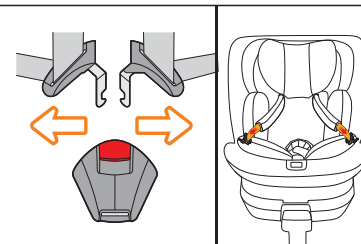

- 8** Place child in the car seat.



Cat No: 4524692

- 9** Please note a correctly adjusted headrest ensures optimal protection for your child in the safety seat; the headrest must be adjusted so that the shoulder straps are at the same level as your child's shoulders or slightly above.

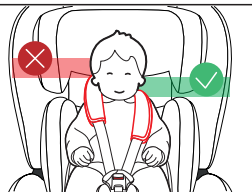

- 10** Guide the two buckle latches together and engage them before putting them into the buckle, this should make a clicking sound.

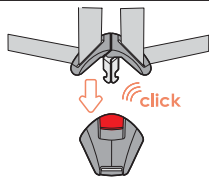

- 11** Tighten the harness adjusting strap and make sure the harness is reasonably tight. It should restrain but not make the child uncomfortable.

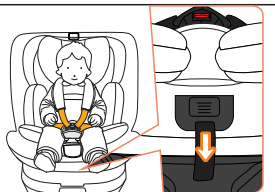

CAUTION

Please ensure that the lap strap is worn low down, so that the pelvis is firmly engaged. Pull on the strap until it lies flat and is close against your child's body. The straps should be correctly adjusted and ensure they are not twisted.

Pull the strap end straight towards you, not upwards or downwards. Please pay attention to the strap end. Whilst travelling (especially outside the car) it should always be attached to the cover.

Cat No: 4524692

- 12** Press the rotating button to adjust the seat direction. Only rearward facing position is available for child under 15 months.

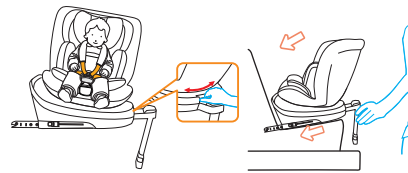

Installation in the vehicle

Installation instruction for Stature 76-105cm, Forward facing, ISOFIX + Support Leg + harness

- 1** Unfold the support leg until it locks in place. Press the ISOFIX release button to slide the ISOFIX connectors to the end.

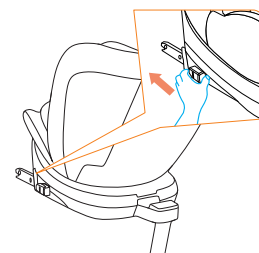

- 2** **Caution:** Please only move to next step when ISOFIX has been slid to the end with the red indicators showing.

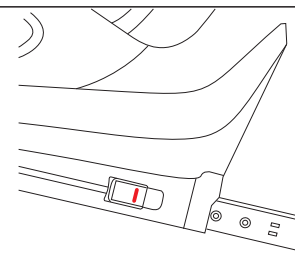

Cat No: 4524692

3 Push the ISOFIX connectors directly into the anchorages until you hear an audible “click” sound.

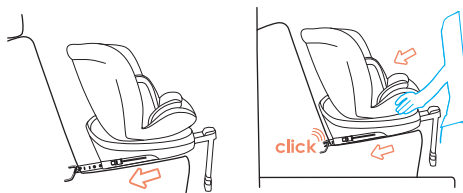

4 Grasp the seat body to check the seat if it is fastened tightly or shakes, meanwhile observe the ISOFIX red/green indicator. If the seat shakes and the ISOFIX connectors are pulled out, please repeat the above steps and install it again.

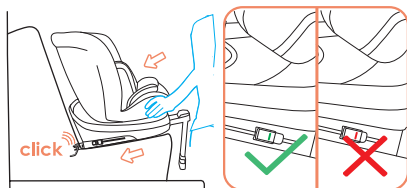

5 Squeeze the support leg adjusting button, pull out the support leg until it rests firmly on the floor. Observe the ISOFIX red/green indicator to confirm the installation status.

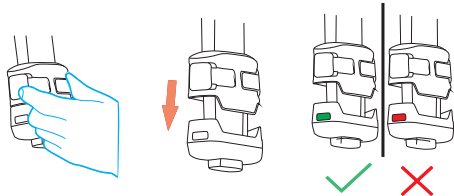

Cat No: 4524692

6 Press the rotating button, adjust the seat to sideward facing position allow access for placing a child from the seat unit after the car seat is fitted.

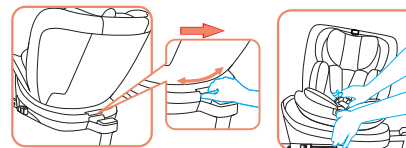

CAUTION

Before every journey, make sure that the rotating part has been fully engaged.
Do not drive unless the seat is in the forward or rearward facing position.

7 Loosen the shoulder straps by pressing the harness adjusting button and pull the harness shoulder as far forward as possible.

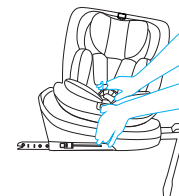

8 Open the buckle by pressing the red button, then fix the shoulder straps at the sides of the car seat.

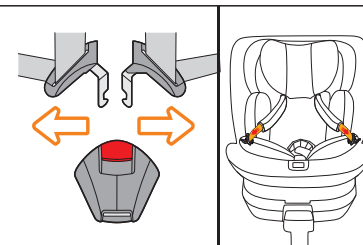

Cat No: 4524692

9 Place child in the car seat.



10 Please note a correctly adjusted headrest ensures optimal protection for your child in the safety seat; the headrest must be adjusted so that the shoulder straps are at the same level as your child's shoulders or slightly above.

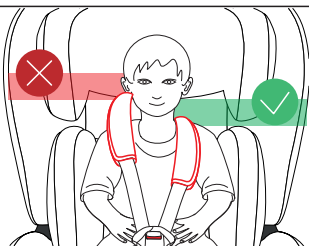

11 Guide the two buckle latches together and engage them before putting them into the buckle, this should make a clicking sound.

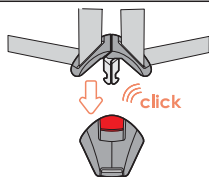

12 Tighten the harness adjusting strap and make sure the harness is reasonably tight. It should restrain but not make the child uncomfortable.

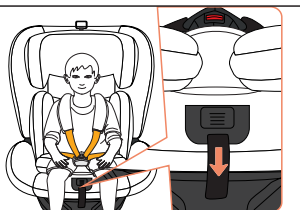

Cat No: 4524692

CAUTION

Please ensure that the lap strap is worn low down, so that the pelvis is firmly engaged. Pull on the strap until it lies flat and is close against your child's body. The straps should be correctly adjusted and ensure they are not twisted.

Pull the strap end straight towards you, not upwards or downwards. Please pay attention to the strap end. Whilst travelling (especially outside the car) it should always be attached to the cover.

13 Press the rotating button to adjust the seat direction. Both forward and rearward facing position are available for child of height 76-105cm.

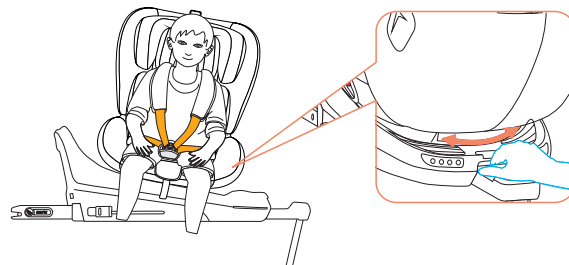

Cat No: 4524692



Installation in the vehicle

Installation instruction for Stature 100-150cm, Forward facing, ISOFIX attachment + vehicle 3 point belt

- 1** Remove the baby insert, loosen the shoulder straps by pressing the harness adjusting button and pull the harness shoulder as far forward as possible.

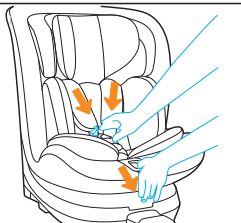

- 2** Place the shoulder straps behind the headrest cover, open the cover of the buckle storage, assemble the buckle properly, then put it in the storage and close it up.

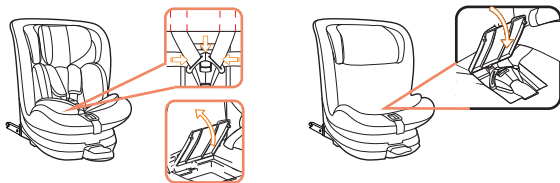

- 3** Fold the support leg under the seat until it locks in place. Press the ISOFIX release button to slide the ISOFIX connectors fully out.

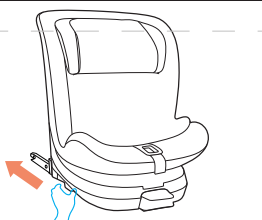

Cat No: 4524692



- 4** **Caution:** Please only move to next step when ISOFIX has been slid to the end with the red indicators showing.

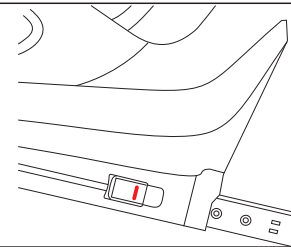

- 5** Push the ISOFIX connectors directly into the anchorages until you hear an audible "click" sound.



- 6** Grasp the seat body to check the seat if it is fastened tightly or shakes, meanwhile observe the ISOFIX red/green indicator. If the seat shakes and the ISOFIX connectors are pulled out, please repeat the above steps and install it again.

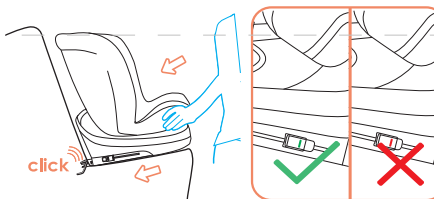

Cat No: 4524692

cuggl 

- 7** Adjust the height if the headrest to suit your child. Put the vehicle belt through the belt guide. Place your child into the baby car seat and let the vehicle belt pass the belt guide. Fasten the vehicle belt with an audible "Click" sound.

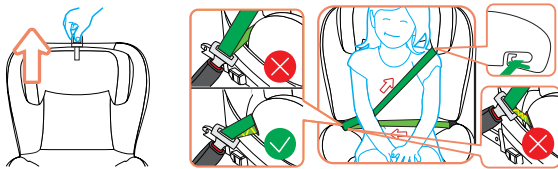

CAUTION

Please ensure that the lap strap is worn low down, so that the pelvis is firmly engaged. Pull on the strap until it lies flat and is close against your child's body. The straps should be correctly adjusted and ensure they are not twisted.

- 8** Remove the baby insert, loosen the shoulder straps by pressing the harness adjusting button and pull the harness shoulder as far forward as possible.

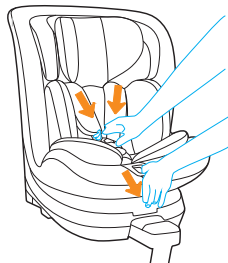

Cat No: 4524692

-22-

cuggl 

- 8** Place the shoulder strap behind the headrest cover, open the cover of the buckle storage, assemble the buckle properly, then put it in the storage and close firmly.

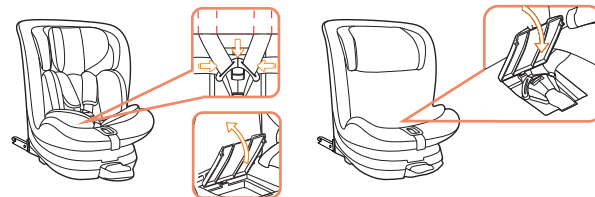

Cat No: 4524692

-23-



Installation in the vehicle

Installation instruction for Stature 100-150cm, Forward facing
+ vehicle 3 point belt

- 1 Put the safety seat on the vehicle seat, the Support leg must be fully stored away underneath.

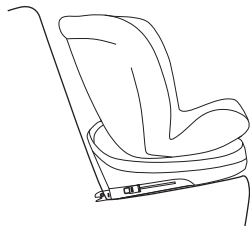

- 2 Adjust the height of the headrest to suit your child. Put the vehicle belt through the belt guide. Place your child into the baby car seat and let the vehicle belt pass the belt guide. Fasten the vehicle belt with an audible "Click" sound.

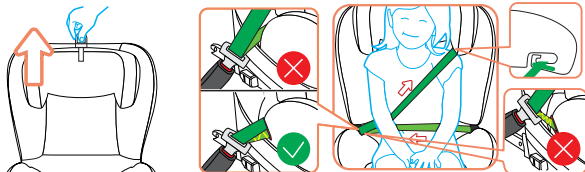

CAUTION

Please ensure that the lap strap is worn low down, so that the pelvis is firmly engaged. Pull on the strap until it lies flat and is close against your child's body.

The straps should be correctly adjusted and ensure they are not twisted.

This unit should be used in a forward upright position only.

The seat can only be rotated when the support leg assembly is extended. Before every journey, make sure that the rotating part has been fully engaged.

Do not drive unless the seat is in either the forward or rearward facing position.

The seat can rotate a full 360°.



CLEANING

Please be sure to use only original Cuggl replacement seat covers, as the seat cover is important to the proper functioning of the system. Replacement seat covers are available from Argos.

⚠ The child seat must not be used without the seat cover.

- The cover can be removed and hand washed at 30°C with a mild detergent. Please observe the instructions on the washing label of the cover. The colours of the cover may fade if washed at more than 30°C. Never tumble dry in an electric clothes dryer (the fabric may separate from the padding).
- The plastic parts can be cleaned using soapy water. Do not use harsh cleaning agents (such as solvents).
- The harness can be removed and washed in lukewarm soapy water.

Caution! Never remove the buckle tongues from the straps.