

GB

IE

MT

DETAILED INSTRUCTIONS

FOR USE OF ELECTRIC
FREE STANDING
COOKER

HDCEIT6C20B

Hisense

You'll soon be enjoying your new Freestanding Cooker

It all begins here, with your instructions. Don't worry, there's nothing too technical coming up. Just simple, step-by-step guidance to get you up and running quickly. Sound good? Then let's get started.

Contents

Safety information

SAFETY INFORMATION 3

Getting to know your Freestanding Cooker

Overview 7

Accessories 8

Installing your Freestanding Cooker

Installation requirements 9

Electrical connection 12

Using your Freestanding Cooker

Control panel 14

Oven functions 18

Using the Induction cooking zones of your cooker 21

General oven and cooking tips 33

Practical Cooking Advice 34

Care and maintenance

Cleaning 36

Replacing the oven lamps 37

How to remove the oven doors 38

Technical Data

Technical specification 39

Energy fiche 40

Product support

Troubleshooting 41

Declaration of conformance to product standards 42

Disposal 42

SAFETY INFORMATION



IMPORTANT

Please read these instructions fully before installing or operating.

INSTALLATION WARNINGS

IMPORTANT: Prior to Installation ensure that the local supply conditions (electricity voltage and frequency) are compatible with the requirements of your freestanding cooker.

IMPORTANT: Carefully unpack and examine the appliance for any damage. If you think there is a defect, do not use the appliance and contact product support. Packaging materials should be collected together and disposed of immediately as they may be harmful to children.

IMPORTANT: Keep the electrical cable (not supplied) of your freestanding cooker away from the hot areas of your appliance, do not let the cable touch the appliance. Keep the cable away from sharp edges and heated surfaces.

IMPORTANT: Ensure that the electric supply cable is not trapped or damaged during installation.

IMPORTANT: In the event that the cable connecting your freestanding cooker becomes damaged, it must be replaced by a suitably qualified person. This cable must not be replaced by an unauthorised person.

IMPORTANT: Protect your freestanding cooker against atmospheric effects. Do not expose your cooker to effects such as sun, rain, snow etc.

IMPORTANT: The materials surrounding the appliance (cabinets) must be able to withstand a minimum temperature of 100°C.

IMPORTANT: When using your oven for the first time your cooker may give off an smoke or an unusual odour from the heating elements and insulation materials. To eliminate this odour run the oven at 250 degrees for 40-60 minutes with the oven empty.

WARNING: Before obtaining access to terminals, all supply circuits must be disconnected.

IMPORTANT: Make sure the oven control knobs are all in the off position when not in use.

IMPORTANT: If you do not intend to use your built in oven for a long period of time then turn off the electric supply to the oven.

SAFETY INFORMATION

DURING USAGE

IMPORTANT: This appliance is not intended to be used by persons (including children) with reduced physical, sensory or mental capabilities, or lack of experience and knowledge, unless they have been given supervision or instruction concerning use of the appliance by a person responsible for their safety. Children should be supervised to ensure that they do not play with their appliance.

WARNING: The appliance and its accessible parts become hot during use. Care should be taken to avoid touching heating elements.

WARNING: NEVER try to extinguish a cooking fire with water. Instead switch off the appliance and cover flame e.g with a lid or a fire blanket.

CAUTION: Do not allow children in the kitchen when cooking or after, as the parts may still be hot. Many parts of the cooker will become hot and present a considerable hazard to children.

CAUTION: When the cooker is hot never touch the oven glass by hand or with tools.

CAUTION: Before starting to use your appliance, ensure curtains, paper or flammable items are kept away from your appliance. Do not keep flammable materials inside of or around your cooker.

CAUTION: Take care when closing the oven door that there is nothing obstructing it from closing as this may break the glass door.

IMPORTANT: The protection shield must be added when using the top oven grill.

IMPORTANT: When the door of the oven is open, do not hang or lean anything on it. You may unbalance your appliance or damage the door or door hinges.

IMPORTANT: Do not hang towels, dishcloths or clothes from the built-in oven or its handles.

GENERAL SAFETY WARNINGS

IMPORTANT: This appliance has been designed for non-professional, domestic use only. Do not use this oven for commercial use or any other application e.g room heating.

WARNING: Danger of fire: do not store flammable items on or near the cooking surfaces or inside the oven.

IMPORTANT: Do not try to lift or move this appliance by pulling on the door handle.

SAFETY INFORMATION

WARNING: Ensure that the appliance is switched off before replacing the lamp to avoid the possibility of electric shock.

IMPORTANT: Your appliance is produced in accordance with all applicable local and international standards and regulations.

IMPORTANT: Maintenance and repair work must only be performed by authorised service technicians. Installation and repair work that is carried out by unauthorised technicians is dangerous and could invalidate your guarantee.

GENERAL SAFETY WARNINGS

IMPORTANT: Always turn the appliance off before operations such as cleaning or maintenance. You can do this by switching the freestanding cooker off using the cooker isolation switch.

IMPORTANT: Do not remove the control knobs to clean the control panel.

WARNING: Do not use harsh abrasive cleaners or sharp metal scrapers to clean the oven door glass since they can scratch the surface, which may result in shattering of the glass.

Getting to know your Freestanding Cooker

Ready? Let's begin...

Please read these instructions carefully. They contain important information which will help you get the best from your freestanding cooker and ensure safe and correct installation and operation.

If you require any further assistance, our technical experts are happy to help. For full details, refer to the product support section at the end of these instructions.

Getting to know your Freestanding Cooker

Overview

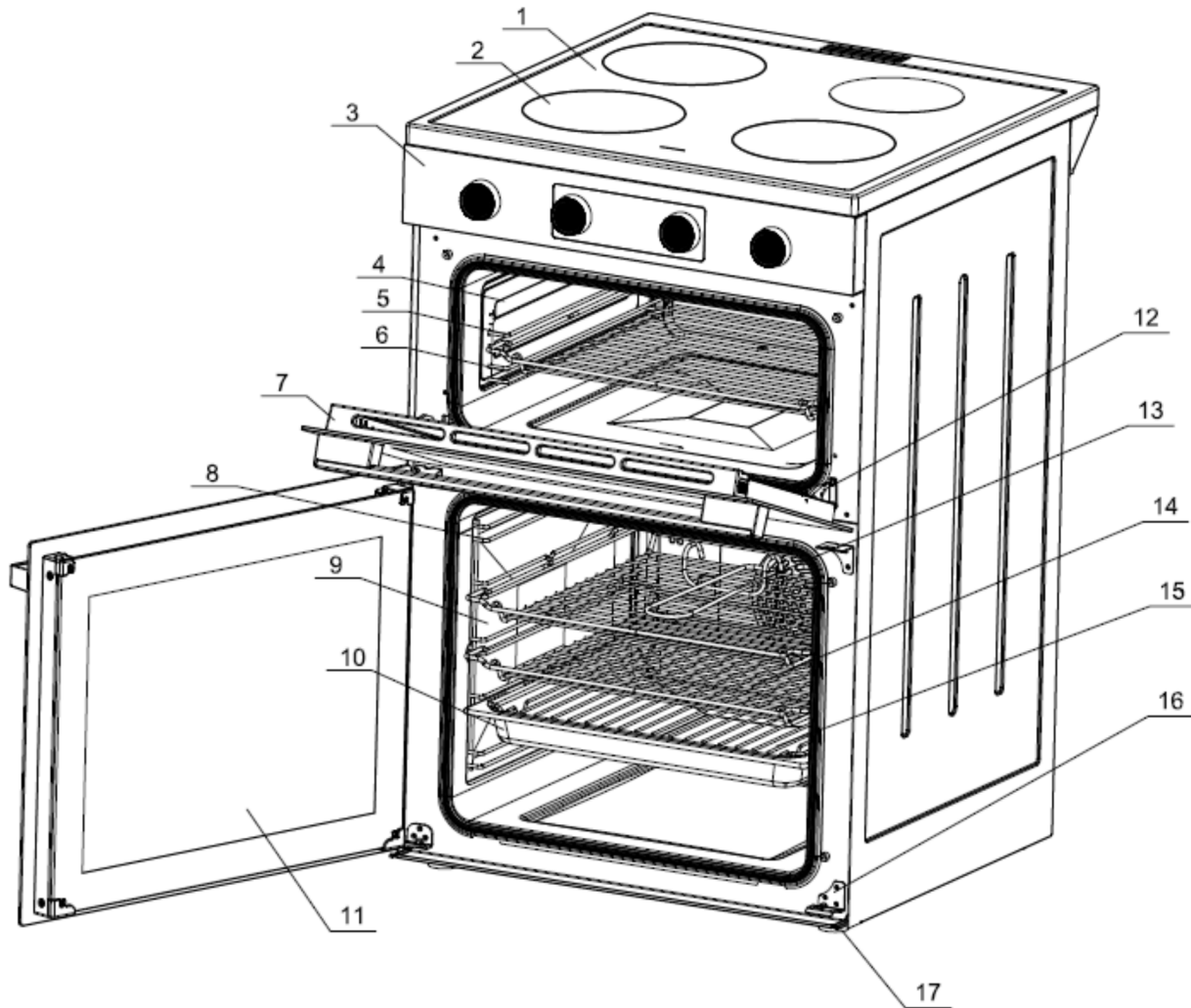

- | | |
|--------------------|--------------------|
| 1. Hob | 9. Catalytic panel |
| 2. Cooking zone | 10. Baking tray |
| 3. Control Panel | 11. Oven Door |
| 4. Catalytic panel | 12. Hinge |
| 5. Shelf positions | 13. Handle |
| 6. Wire Shelf | 14. Wire shelf |
| 7. Oven Door | 15. Inner shelf |
| 8. Shelf positions | 16. Door lock |
| | 17. Anti slip feet |

Getting to know your Freestanding Cooker

Accessories

1. Baking tray x 1

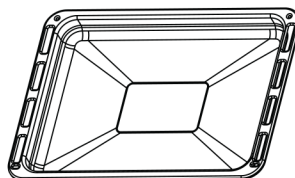

2. Grill x 3

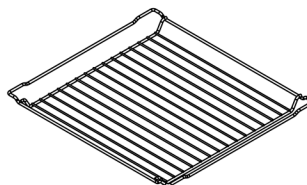

3. Oven Rack x 1

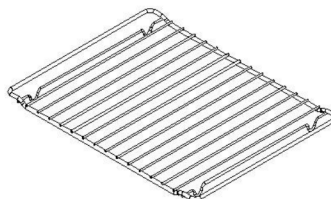

4. Handle x 1

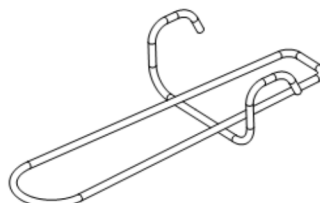

Installing your Freestanding Cooker

Installation requirements

THIS COOKER MUST BE INSTALLED BY A QUALIFIED INSTALLER IN ACCORDANCE WITH LOCAL REGULATIONS.



IMPORTANT: CONTACT AN AUTHORISED SERVICE AGENT FOR INSTALLATION OF YOUR FREESTANDING COOKER!

Positioning

1. Make sure that there are no combustible or flammable materials, such as curtains, in the vicinity of the installation.
2. Furniture and cabinets surrounding the cooker must be of material resistant to temperatures greater than 100°C.
3. Surrounding furniture, cabinets and extractor fans should be positioned in accordance with the diagram shown in the figure 1.

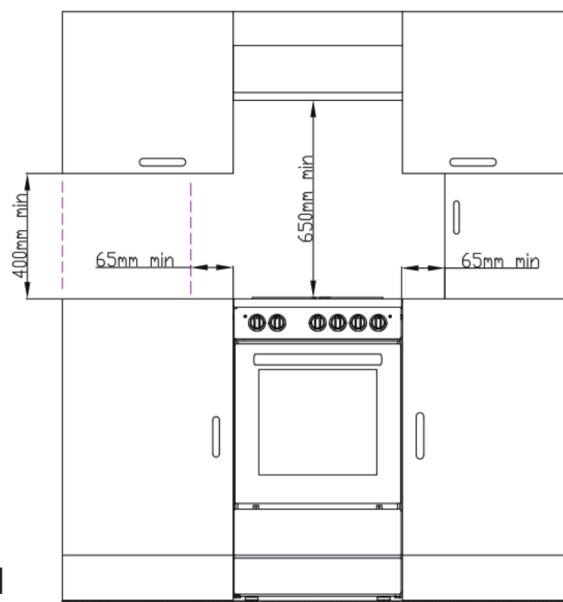

Figure 1

4. If fitted, the extractor fan must be at least 65cm above the hotplates. If no fan is fitted the minimum distance between the hotplates and any cabinet or other structure must be 75cm.

First Use

IMPORTANT: When using your oven for the first time your cooker may give off smoke or an unusual odour from the heating elements and insulation materials. This is normal for new cookers. To eliminate this odour run the oven at 250 degrees for 40-60 mins with the oven empty.

Installing your Freestanding Cooker

Unpacking

Carefully unpack and examine the appliance for any damage.

Levelling feet

The height and level of the appliance can be adjusted by rotating the feet located underneath the appliance at each corner. Rotate the feet to decrease or increase the height.

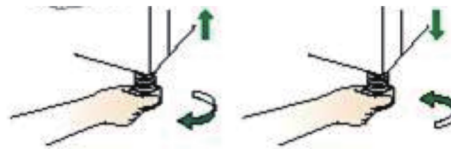

Safety chain

The appliance must be secured against the possibility of tipping forward by using the supplied safety chains attached to the rear of your oven. Fasten the stability hook provided by inserting a wall plug into the kitchen wall and then connect the safety chain to the hook via the locking mechanism.

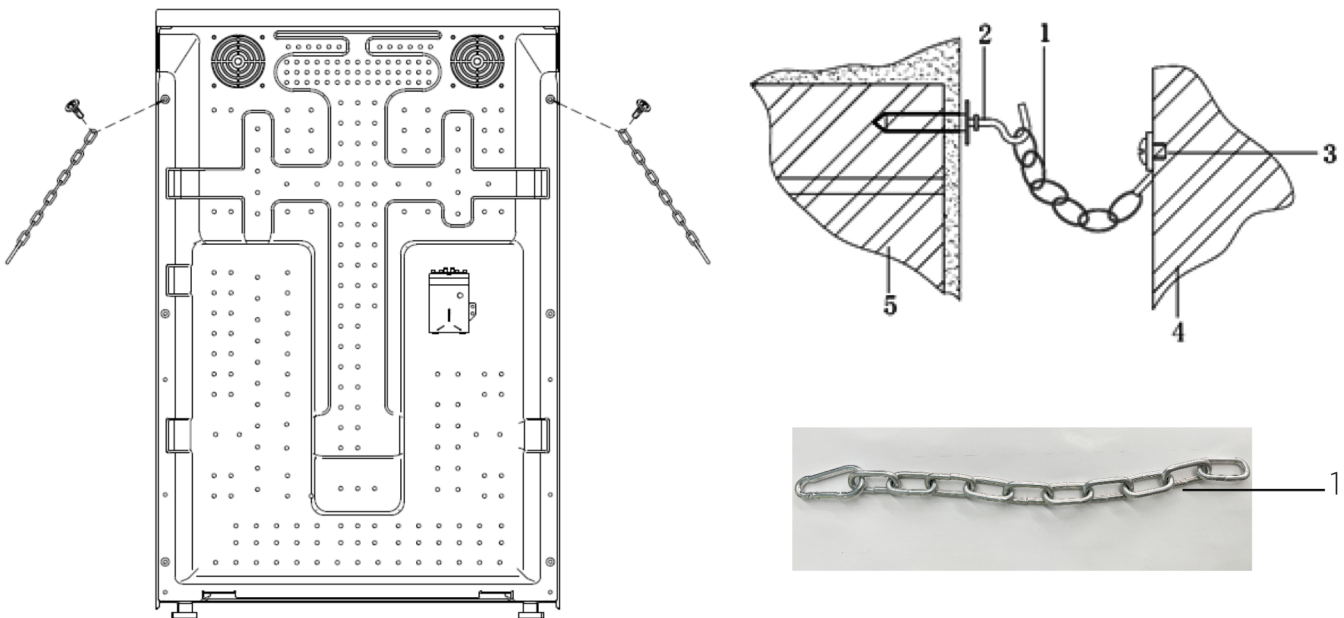

1. Safety chain (supplied in the Accessory bag)
2. Stability hook (no supplied)
3. Screw (Installed in the rear of the cooker)
4. Rear of the cooker
5. Kitchen wall

Installing your Freestanding Cooker

Installation and use of baffle

When using the upper chamber, please install the baffle at the bottom of the panel first;

1. Place the baffle at the screw hole corresponding to the bottom of the surface analyzer;
2. Use attachment screws to secure the baffle to the panel;

As shown in the figure:

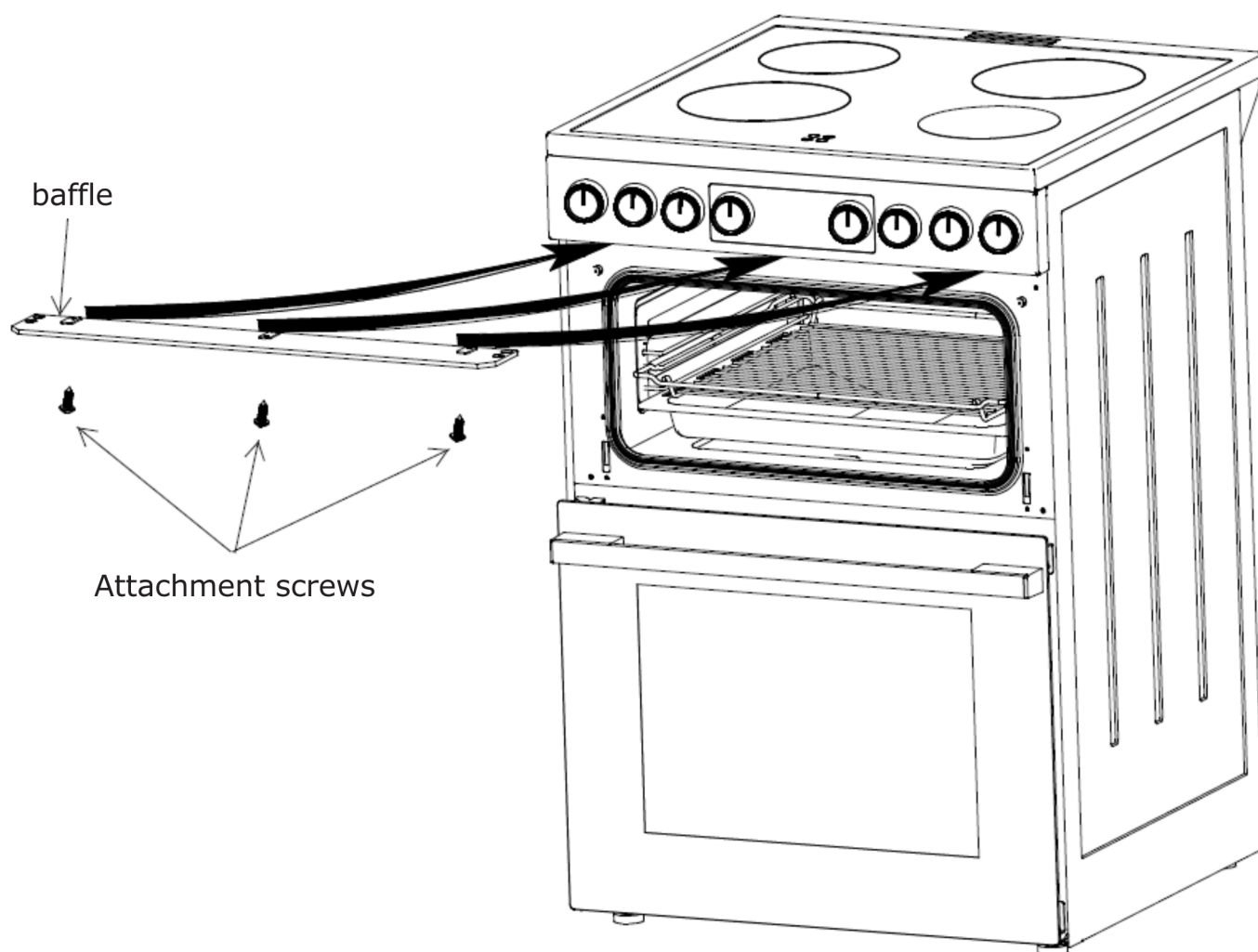

Installing your Freestanding Cooker

Electrical connection

IMPORTANT: Electrical connections must be carried out by a suitably qualified person and in accordance with all relevant local building and installation regulations.

Fitting on a Power Supply Cable

Connecting appropriate power supply terminal board/ connector block:

- Using a screwdriver, prize open tabs of the Terminal board cover.
- Remove the wire clamp screw.
- Fasten the wires beneath the corresponding screw heads, using brass 'link' for single phase supply.
- Fasten cable clamp and close the cover of the terminal board.
- The ac power supply should be 220-240 V, 50/60 Hz.

Connecting the supply cable to the mains

Install an approved circuit breaker with a minimum contact opening of 3 mm, between the appliance and the mains Distribution board .The circuit breaker should be sized according to the load and should comply with current regulations (the earth wire should not be interrupted by the circuit breaker).

The supply cable should be positioned so that it does not reach a temperature of more than 50°C with respect to the room temperature, anywhere along its length. Before switching fuse ON in meter-box check:

- Earth continuity. The electrical safety of this appliance can only be guaranteed if the cooker is correctly installed and earthed, in compliance with regulations on electrical installations.
- The electrical capacity of the system and sockets will support the maximum power of the appliance, as indicated on the data plate.

Installing your Freestanding Cooker

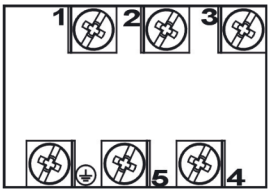
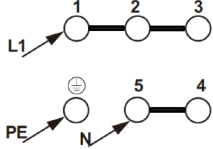
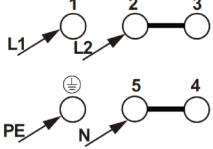
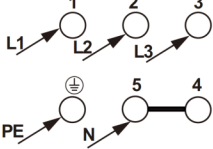
CONNECTION DIAGRAM				Recommended type of connection lead
Caution! Voltage of heating elements 230V Caution! In the event of any connection the safety wire must be connected to the PE terminal				
For 230 V earthed one - phase connection, bridges connect 1-2-3 terminals and 4 - 5 terminals, safety wire to PE .				H05VV-F3G6 Fuse 32 A
For 400/230 V earthed two - phase connection, bridges connect 2 - 3 terminals and 4 - 5 terminals, the safety wire to PE.				H05VV-F4G2,5 Fuse 20 A x2
For 400/230V earthed three -phase connection, bridges connect 4 - 5 terminals, phases in succession 1,2 and 3, earth to 4 - 5, the safety wire to PE.				H05VV-F5G1,5 Fuse 16 A x3
L1=R,L2=S,L3=T,N=earth terminal, PE= safety wire terminal				

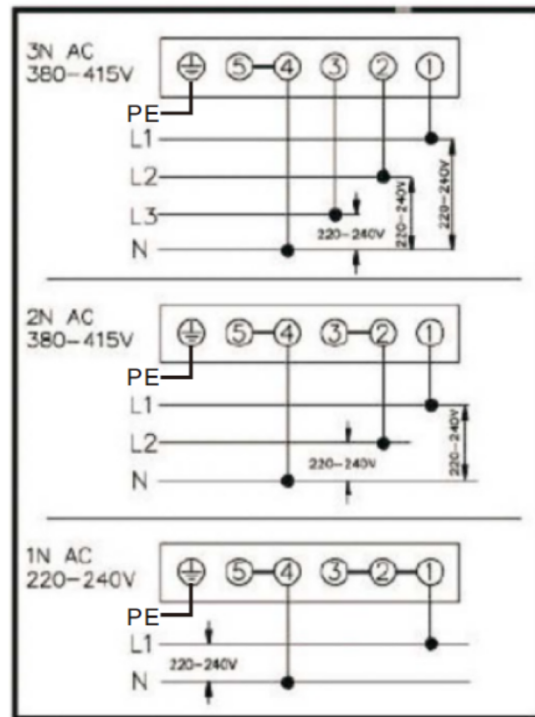
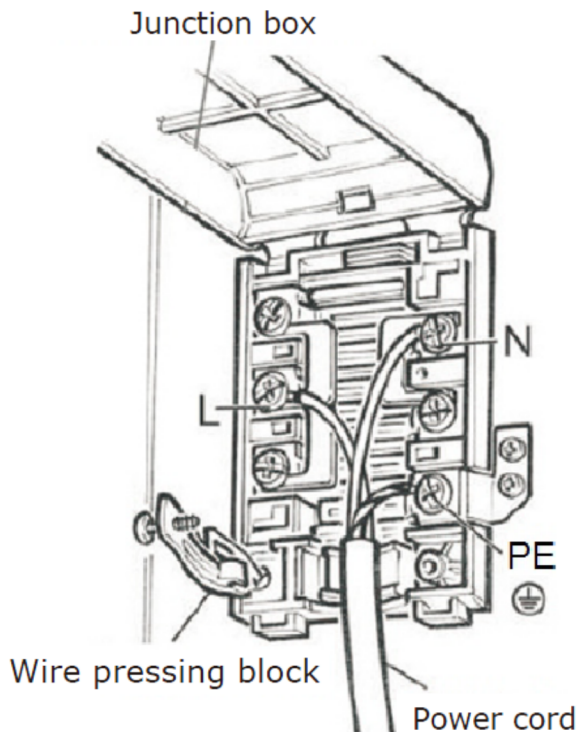

Using your Freestanding Cooker

Control Panel

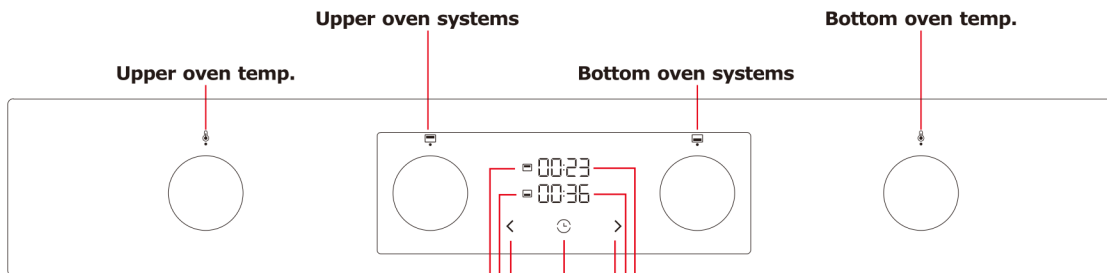

Upper Oven icon - time related
Illuminated icon, without touch, illuminated 50%, 75%, 100%, blinking

Bottom Oven icon - time related
Illuminated icon, without touch, illuminated 50%, 75%, 100%, blinking

Decrease function - time related
Touch key, printed icon.
With one press, the value can be reduced by 1 minute, by holding the touch key (2 sec) values start automatically decreasing first up to full value later for 10 minutes, later for 1 hour.
Example: 02:02, 02:01, 02:00, 01:50, 01:40...00:00.

Time function for bottom and upper oven
Touch key, printed icon.
Function is available only if bottom or upper oven program is selected. With one press time function for bottom or upper oven can be activated. If only one oven is running (bottom or upper) by activation the time function the duration digits are automatically connected and starts blinking periodically. By pressing the decrease or increase touch keys duration can be selected. By no touch (8 sec) time function/digits disappear, world time is visible again. When time function is selected time digits start decreasing automatically without confirmation. When reach the end time 00:00 function automatically finish the program and complete the process. Time function in running can be canceled/deleted by simultaneously touch on decrease and increase touch key or by setting the 00:00 value. After this time digits disappear by not touch for 8 sec. automatically. If the time function is activated for both ovens (bottom/upper) both time values are active. By pressing the time touch key we can toggle between upper or bottom time value.

Time Digits - Bottom oven
Illuminated digits, 7 segments, without touch. Illuminated icon, without touch, illuminated 50%, 75%, 100%, blinking

Time Digits - Bottom oven
Illuminated digits, 7 segments, without touch. Illuminated icon, without touch, illuminated 50%, 75%, 100%, blinking

Increase function - time related
Touch key, printed icon. With one press, the value can be increased by 1 minute, by holding the touch key (2 sec) values start automatically increasing first up to full value later for 10 minutes, later for 1 hour.
Example: 00:07, 00:08, 00:09, 00:10, 00:20...01:00, 02:00.

Hisense Display- Off mode, out of electricity



Hisense Display- All content activated

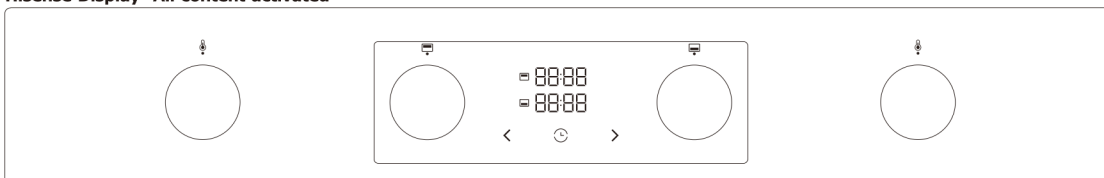

Using your Freestanding Cooker

Hisense Display-Starting Wizzard - World time Set

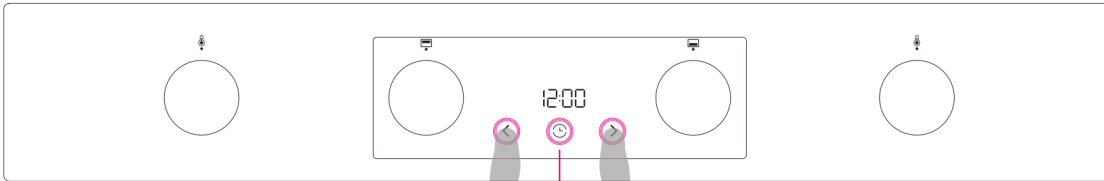

1. By pressing the decrease or increase touch keys World time can be selected. Pre-set time is 12:00. With one press, the value can be increased by 1 minute, by holding the touch key (2 sec) values start automatically increasing first up to full value later for 10 minutes, later for 1 hour. Function is the same if for increase or decrease the value. Example: 00:07, 00:08, 00:09, 00:10, 00:20...01:00,02:00.

Hisense Display- Starting Wizzard - World time Set

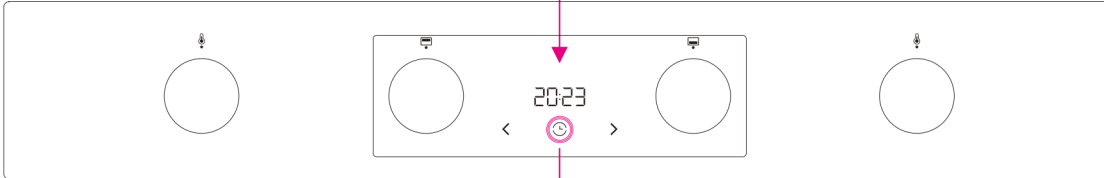

2. By pressign the time touch key World time is confirmed, display goes to next screen(Brightness).

Hisense Display-Starting Wizzard - Brightness Set

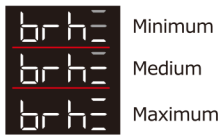
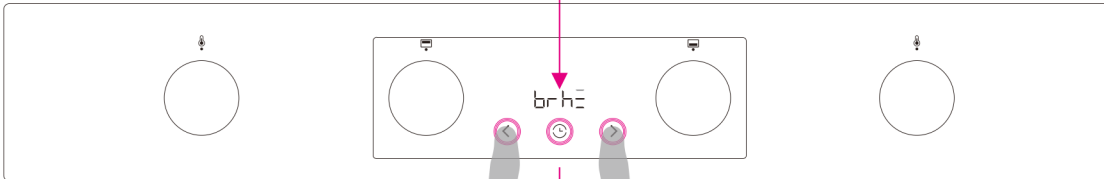

1. By pressing the decrease or increase touch keys brightness level (low, mid, high) can be selected. Pre-set Brightness is Medium.
2. By pressign the time touch key Brightness level is confirmed, display goes to next screen (Volume settings).

Hisense Display-Starting Wizzard - Volume Set

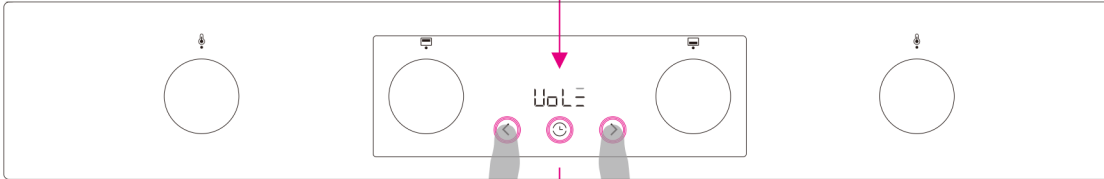

1. By pressing the decrease or increase touch keys Volume level (low, mid, high, off) can be selected. Pre-set Volume is Medium.
2. By pressign the time touch key Volume level is confirmed, display goes to next screen (World time settings).

Hisense Display-Standby

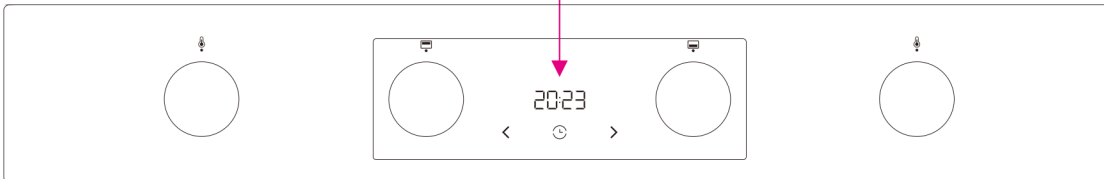

In stanby World time is active. Touch keys are not active-only time touch key if pressing and holding the touchkey for 3 sec the settings menu can be activated. Settings menu is the same like Starting Wizzard where brightness, volume and world time can be adjusted.

Using your Freestanding Cooker

Hisense Display-Upper oven - program selection - time function

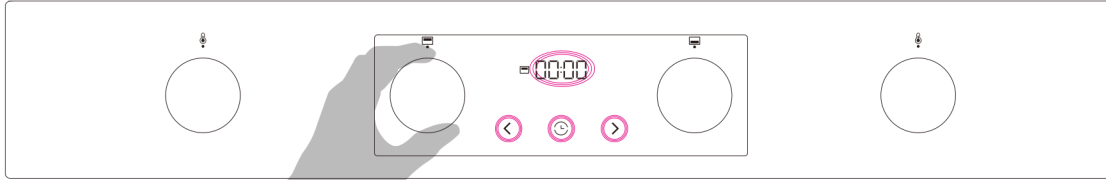

1. By rotating the knob upper oven systems/programs can be selected. Time digits for the upper oven is automatically active/pre-set and blinking periodically. Upper oven icon is fully illuminated and not blinking.
2. Duration can be selected by pressing the decrease or increase touch key on the same way like all time related functions.

*If time touch keys are not pressed in 10 sec, digits disappear, time function is not active anymore. Time function can be activated by pressing the time touch key. Time functions for the bottom or upper oven are possible to select only if system knob (upper or bottom oven) is rotated and the program is selected.

Hisense Display-Upper oven - program selection - time functions - running

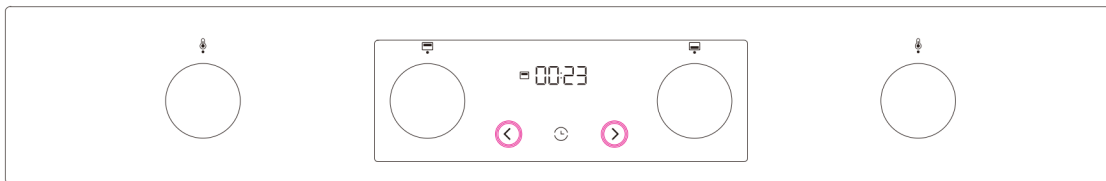

When the duration is set and the time touch keys are not pressed for 5 sec, time function/digits start automatically counting down up to 00:00. In running digits are not blinking, only dots between digits blink all the running process.

By pressing the decrease/increase touch keys during the running/baking process, the time can be adjusted directly. Time functions/durations can be canceled/deleted by simultaneously pressing both decrease and increase touch keys or by setting the time value on 00:00. Time functions are deleted also by rotating the system knob to off position.

Hisense Display-Upper oven - program selection - time functions - Program completed

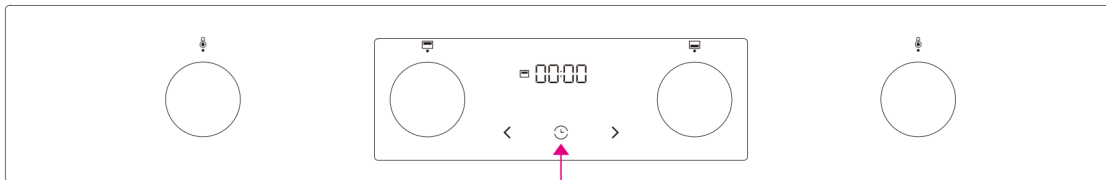

When the program is completed, digits/display toggle between 00:00 and End for 2 min. Finish sound / Alarm is active. Upper oven icon is illuminated fully and not blinking. Oven function is automatically switched off, program is completed.

Hisense Display-Upper oven - program selection - time functions - Program completed

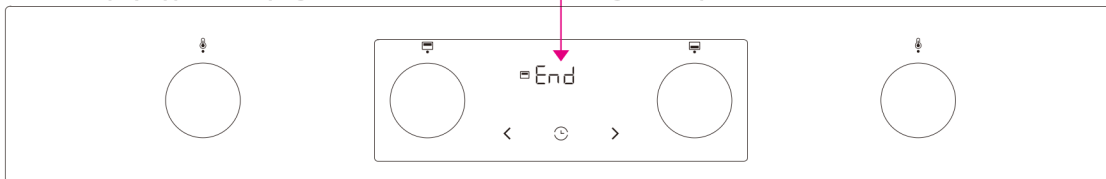

By rotating the upper oven knob on off position, the oven functionality is deactivated, standby mode is active (world time).

Hisense Display-Upper and bottom oven activated at the same time

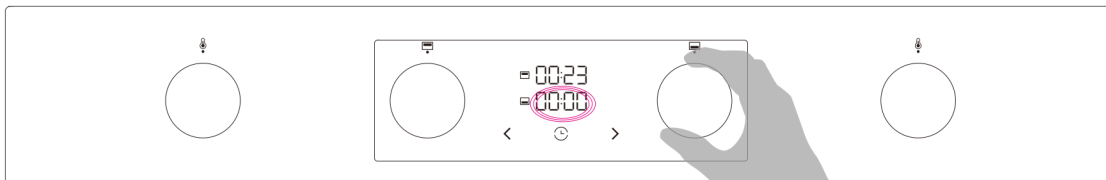

1. Both ovens (bottom and upper) can be active at the same time. If the bottom or upper oven is activated (by rotating the system knob) when one of the ovens is already active and is in running mode, time function is automatically active, ready to select, digits are blinking.

Using your Freestanding Cooker

- Duration can be selected by pressing the decrease or increase touch key on the same way like all time related functions.

*If time touch keys are not pressed in 10 sec, digits disappear time function is not active anymore. Time function can be activated by pressing the time touch key. With time touch key we can toggle between bottom or upper oven duration and than set the values by decrease or increase touch keys. Time functions for the bottom or upper oven are possible to select only if system knob (upper or bottom oven) is rotated and the program is selected.

Hisense Display- Upper and bottom oven activated at the same time -Running

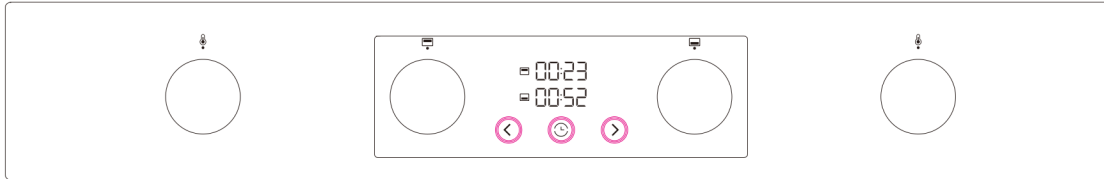

When the duration is set and the time touch keys are not pressed for 5 sec time function/digits starts automatically counting down up to 00:00. In running digits are not blinking, only dots between digits blinking all the running process.

Last setted/ adjusted time is in primary position and can be adjusted in running mode anytime by pressing the decrease/increase touch keys directly. By pressing the time touch key we can toggle between bottom or upper durations and later adjust it if needed,

Hisense Display-Upper and bottom oven activated at the same time - Upper oven process completed

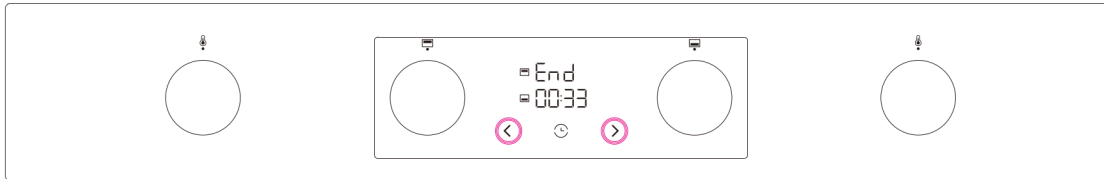

When the program is completed digits/display toggle between 00:00 and End for 2 min. Finish sound /Alarm is active. Upper oven icon is illuminated fully and not blinking. Oven function is automatically switched off, program is completed.

Bottom oven duration is still active and can be adjusted directly by pressing the decrease or increase touch keys.

Hisense Display- Bottom oven - program selection - time function

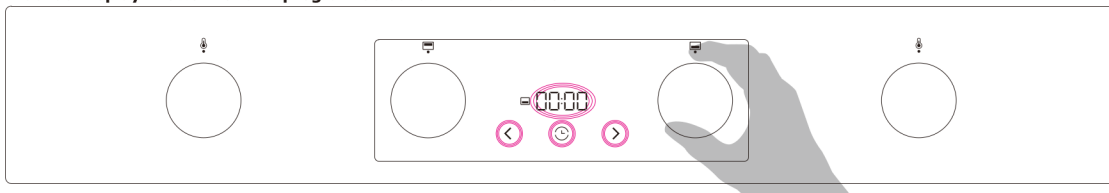

- By rotating the knob bottom oven systems/programs can be selected. Time digits for the bottom oven are automatically active/pre-set and blinking periodically. Bottom oven icon is fully illuminated and not blinking.
- Duration can be selected by pressing the decrease or increase touch key on the same way like all time related functions.

*If time touch keys are not pressed in 10 sec, digits disappear time function is not active anymore. Time function can be activated by pressing the time touch key. Time functions for the bottom or upper oven are possible to select only if system knob (upper or bottom oven) is rotated and the program is selected.

Hisense Display- Bottom oven - program selection - time functions - running

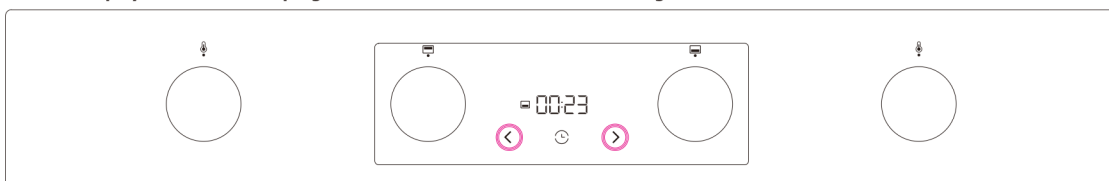

When the duration is set and the time touch keys are not pressed for 5 sec time function/digits starts automatically counting down up to 00:00. In running digits are not blinking, only dots between digits blinking all the running process.

Using your Freestanding Cooker

By pressing the decrease/increase touch keys during the running/baking process the time can be adjusted directly. Time functions/durations can be canceled/deleted by simultaneously pressing on both decrease and increase touch keys or by setting the time value on 00:00. Time functions are deleted also by rotating the system knob to off position.

Hisense Display-Bottom oven - program selection -time functions - Program completed

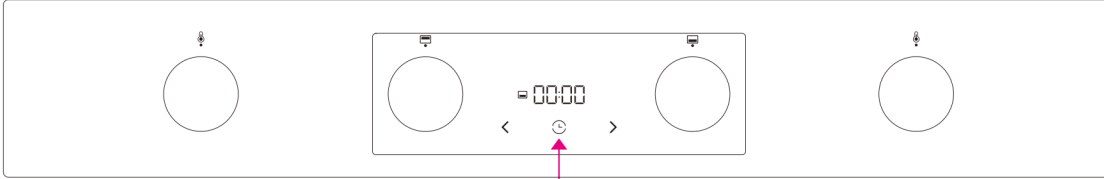

When the program is completed digits/display toggle between 00:00 and End for 2 min. Finish sound / Alarm is active. Bottom oven icon is illuminated fully and not blinking. Oven function is automatically switched off, program is completed.

Hisense Display-Bottom oven - program selection -time functions - Program completed

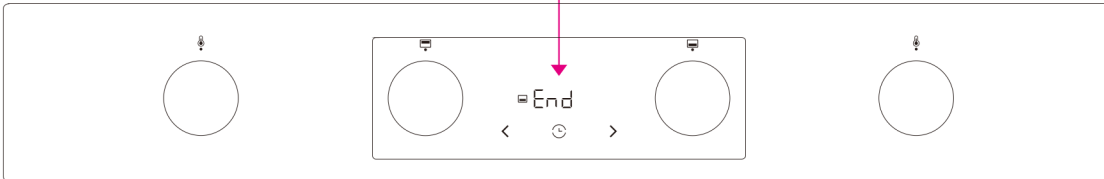

By rotating the bottom oven knob on off position the oven functionality is deactivated, standby mode is active (world time).

Oven functions

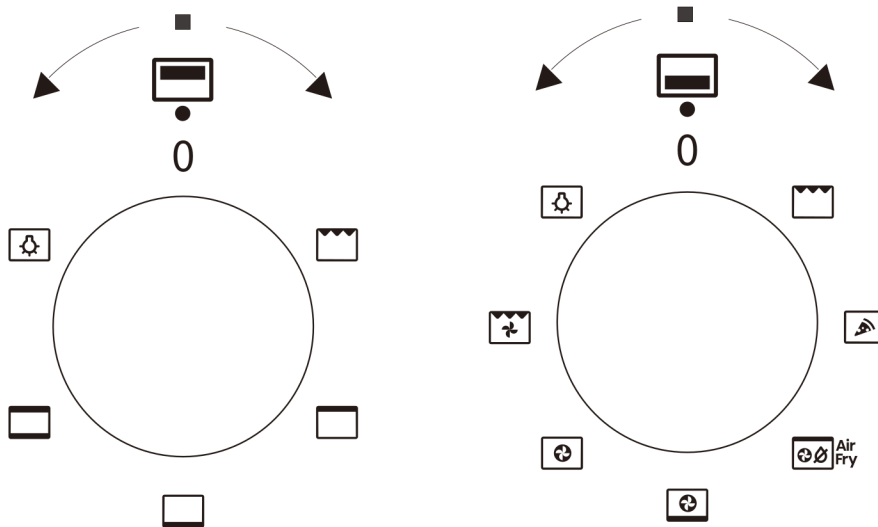

Note: The indicator icon is on the knob



OVEN LIGHT: Separate light control which allows the light to be switched on, even when the oven is not cooking.



Conventional: Hot air comes from the upper and lower element in the oven. This is called Conventional cooking and is ideal for joints of meat.

Using your Freestanding Cooker



Bottom Element: Bottom element cooking is used for foods that typically need cooking with heat from underneath - Cakes and Bread are examples of where this function would be useful.



Grill: The top central heating elements comes on .The extremely high and direct temperature of the grill makes it possible to brown the surface of meats and roasts while locking the juices in to keep them tender. The grill is also highly recommended for dishes that require a high temperature on the surface: beef steaks, veal, rib steak, fillets, hamburgers etc.



Top heater on:

Setting the knob to this position allows the oven to be heated only with the top heater switched on, e. g. use for final baking from above.



Grill with fan On:

Excellent combination for cooking spit roasted chicken game and a variety or roasts.



Fan Oven:

When set to Baking mode, the fan element and the fan operate providing a delicate heat distributed uniformly throughout the oven. This mode is ideal for baking and cooking delicate foods on multiple shelves, especially cakes that need to rise such as cream puffs and for certain tartlets, sweet or savory biscuits, savory puffs, swiss rolls and small portions of vegetables. etc.



Bottom and Round Back Element with Fan:

This setting heats from the bottom and back round elements with fan assisted heat distribution more evenly around the oven's cavity. This function is suitable for cooking and baking when extensive heat required providing crispy base and crunchy surface to the dish.

Using your Freestanding Cooker



Air Fry

Air fry function:

By utilizing the rapid heating function, the internal air is accelerated and evenly distributed, allowing the food to ripen; At the same time, the hot air also blows away the moisture on the surface of the food, making the ingredients achieve a similar frying effect.



Pizza function:

This feature is specifically designed to use pizza for baking, making pizza more delicious

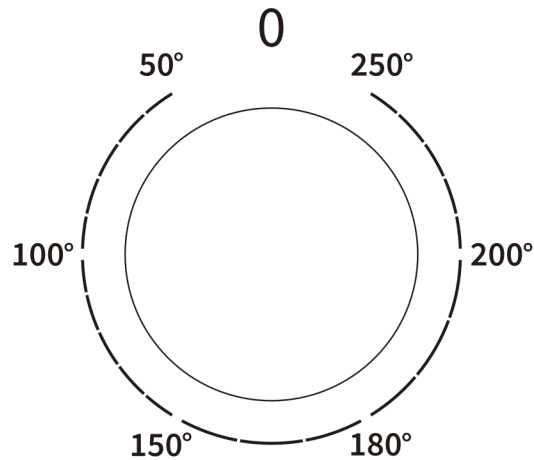

Note: The indicator icon is on the knob

as well as the temperature regulator knob-to set a required function you should turn the knob to the selected position.

Using your Freestanding Cooker

Using the Induction cooking zones of your cooker

Hob Top View

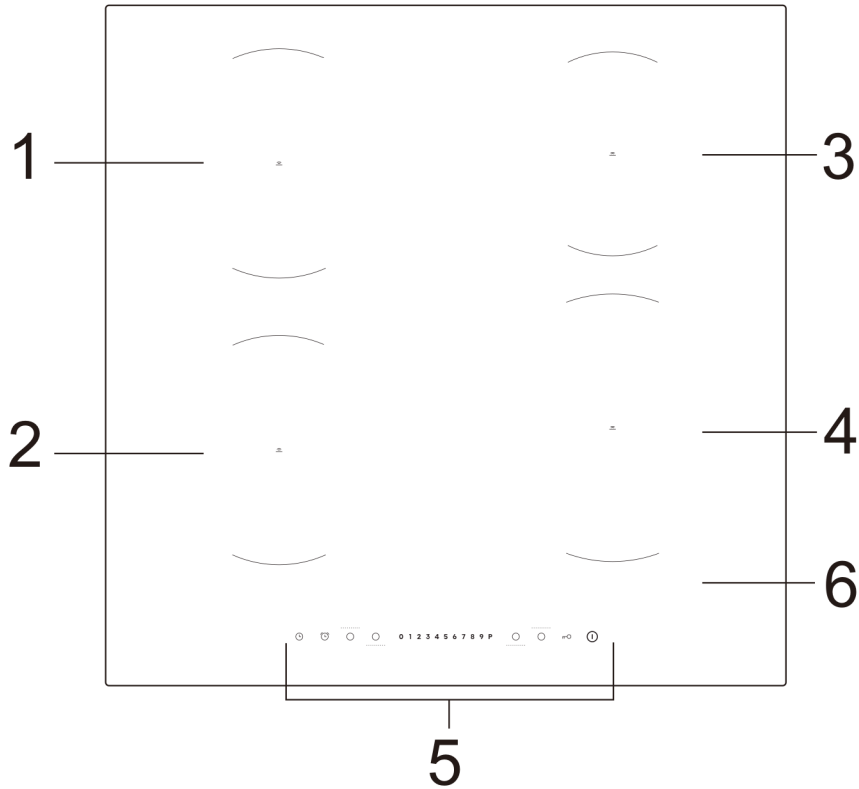

1. max. 1800/2300 W zone
2. max. 1800/2300 W zone
3. max. 1200/1500 W zone
4. max. 2300/3000 W zone
5. Control panel
6. Glass plate

Using your Freestanding Cooker

Hob Control Panel

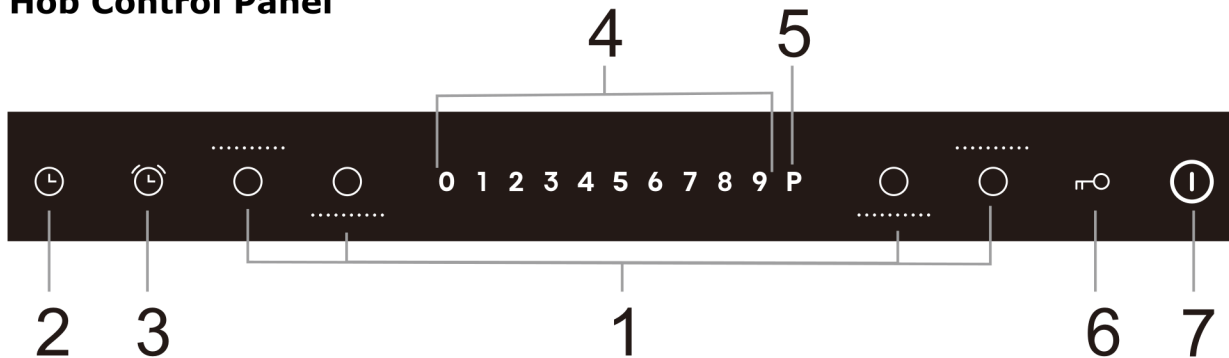

- 1. Heating zone selection controls
- 2. Timer control
- 3. Time Clock
- 4. Power / Timer slider touch control
- 5. Boost control
- 6. Keylock control
- 7. ON/OFF control

Induction Cooking

Induction cooking is a safe, advanced, efficient, and economical cooking technology. It works by electromagnetic vibrations generating heat directly in the pan, rather than indirectly through heating the glass surface. The glass becomes hot only because the pan eventually warms it up.

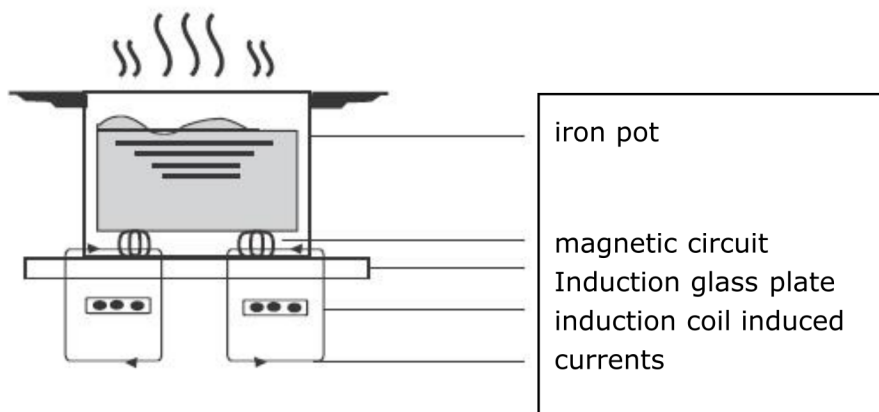

Using your Freestanding Cooker

Before using your New Induction Hob

- Read this guide, taking special note of the 'Safety Warnings' section.
- Remove any protective film that may still be on your Induction hob.

Using the Touch Controls

- The controls respond to touch, so you don't need to apply any pressure.
- Use the ball of your finger, not its tip.
- You will hear a beep each time a touch is registered.
- Make sure the controls are always clean, dry, and that there is no object (e.g. a utensil or a cloth) covering them. Even a thin film of water may make the controls difficult to operate.

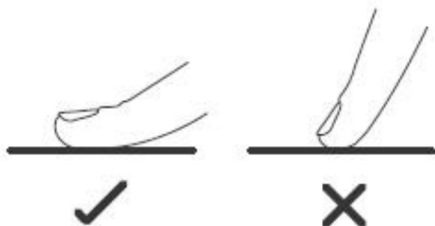

Choosing the right Cookware



- Only use cookware with a base suitable for induction cooking. Look for the induction symbol on the packaging or on the bottom of the pan.
- You can check whether your cookware is suitable by carrying out a magnet test. Move a magnet towards the base of the pan. If it is attracted, the pan is suitable for induction.

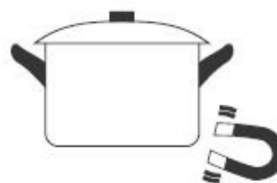

Using your Freestanding Cooker

Do not use cookware with jagged edges or a curved base.



Make sure that the base of your pan is smooth, sits flat against the glass, and is the same size as the cooking zone. Use pans whose diameter is as large as the graphic of the zone selected. Using a pot a slightly wider energy will be used at its maximum efficiency. If you use smaller pot efficiency could be less than expected. Pot less than 140 mm could be undetected by the hob. Always centre your pan on the cooking zone.

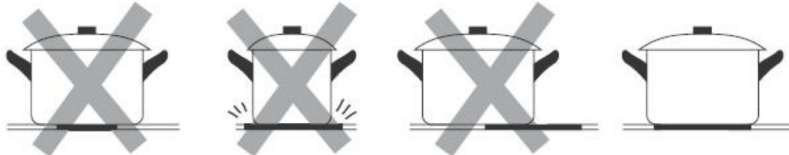

Always lift pans off the Induction hob – do not slide, or they may scratch the glass.



Using your Induction Hob

To start cooking

1. Connect the power ⓘ the buzzer beeps once, all displays will show "0." or "00." and the induction lights of the slider touch control will blink once, then lights go out. Press the ON/OFF control, the displays will show "0" or "00" and the lights always being on. It indicates that the induction hob has entered the state of standby mode.



Using your Freestanding Cooker

2. Place a suitable pan on the cooking zone that you wish to use.

- Make sure the bottom of the pan and the surface of the cooking zone are clean and dry.

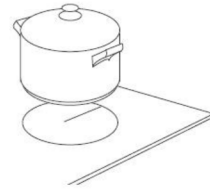

3. Touching the heating zone selection control, the indicator next to the button will show "5" and flash 5 seconds. If there is no operation in 1 minute, the buzzer beeps once and the hob will go into the standby mode. Press the ON/OFF Control again to restart the hob.



4. Adjust heat setting by touching the slider control.

- If you don't choose a heat setting within 1 minute, the Induction hob will automatically switch off. You will need to start again at step 1.
- You can modify the heat setting at any time during cooking.

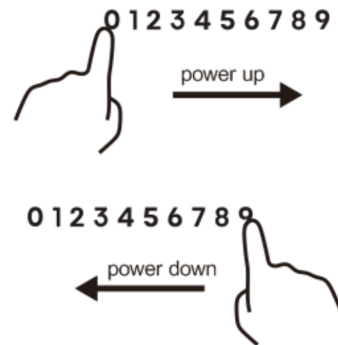

If the display flashes setting alternately with the heat setting

- you have not placed a pan on the correct cooking zone or,
- the pan you're using is not suitable for induction cooking or,
- the pan is too small or not properly centered on the cooking zone.

No heating takes place unless there is a suitable pan on the cooking zone. The display will automatically turn off after 2 minutes if no suitable pan is placed on it.

Using your Freestanding Cooker

When you have finished cooking

1. Touching the heating zone selection control that you wish to switch off



2. Turn the cooking zone off by touching the slider to "0". Make sure the display shows "0".



3. Turn the whole cooktop off by touching the ON/OFF control.



4. Beware of hot surfaces H will show which cooking zone is hot to touch. It will disappear when the surface has cooled down to a safe temperature. It can also be used as an energy saving function if you want to heat further pans, use the hotplate that is still hot.



Using your Freestanding Cooker

Using the Boost function

Activated the boost function

1. Touching the heating zone selection control



2. Touching the boost control, the zone indicator show "P" and the power reach Max.

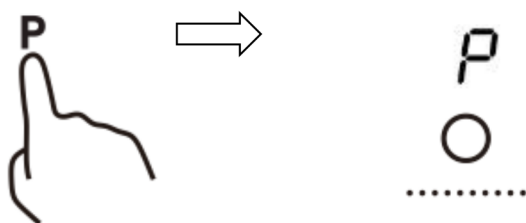

Cancel the Boost function

1. Touching the heating zone selection control that you wish to cancel the boost function



2. Touching the "Boost" control **B** to cancel the Boost function, then the cooking zone will revert to its original setting.

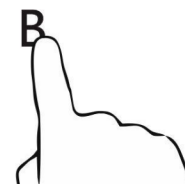

Using your Freestanding Cooker

Locking the Controls

- You can lock the controls to prevent unintended use (for example children accidentally turning the cooking zones on).
- When the controls are locked, all the controls except the ON/OFF control are disabled.

To lock the controls

Touch the keylock  control. The timer indicator will show "Lo"

To unlock the controls

1. Make sure the Induction hob is turned on.
2. Touch and hold the keylock control  for a while.
3. You can now start using your Induction hob.



When the hob is in the lock mode, all the controls are disabled except the ON/OFF, you can always turn the induction hob off with the ON/OFF control in an emergency, but you shall unlock the hob first in the next operation.

Over-Temperature Protection

A temperature sensor equipped can monitor the temperature inside the Induction hob. When an excessive temperature is monitored, the Induction hob will stop operation automatically.

Detection of Small Articles

When an unsuitable size or non-magnetic pan (e.g. aluminium), or some other small item (e.g. knife, fork, key) has been left on the hob, the hob automatically go on to standby in 1 minute.

Using your Freestanding Cooker

Auto Shutdown Protection

Auto shut down is a safety protection function for your induction hob. It shut down automatically if ever you forget to turn off your cooking. The default working times for various power levels are shown in the below table:

Power level	1	2	3	4	5	6	7	8	9
Default working timer (hour)	8	8	8	4	4	4	2	2	2

When the pot is removed, the induction hob can stop heating immediately and the hob automatically switch off after 2 minutes.

 People with a heart pace maker should consult with their doctor before using this unit.

Using the Timer

Setting the timer to turn one or more cooking zones off

If the timer is set on one zone:

1. Touching the heating zone selection control that you want to set the timer for.

2. Touch timer control , the "10" will show in the timer display. and the "0" flashes.

3. Set the time by touching the slider control. (e.g. 5)



Using your Freestanding Cooker

4. Touch timer control again, the "1" will flash.



5. Set the time by touching the slider control (e.g.9), now the timer you set is 95 minutes.(You can set the timer up to 99 minutes.)



6. When the time is set, it will begin to count down immediately. The display will show the remaining time.

NOTE: The red dot next to power level indicator will illuminate indicating that zone is selected.



7. When cooking timer expires, the corresponding cooking zone will be switch off automatically.

 Other cooking zone will keep operating if they are turned on previously.

If the timer is set on more than one zone:

1. When you set the time for several cooking zones simultaneously, decimal dots of the relevant cooking zones are on. The minute display shows the min.timer. The dot of the corresponding zone flashes.

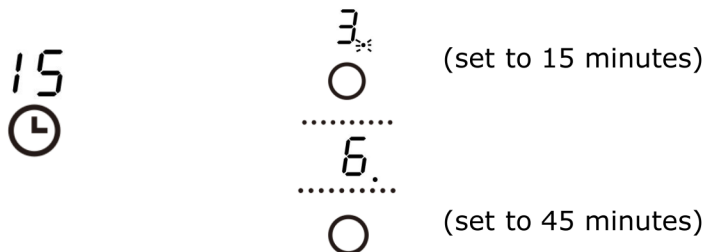

Using your Freestanding Cooker

2. Once the countdown timer expires, the corresponding zone will switch off. Then it will show the new min. timer and the dot of corresponding zone will flash.



Touch the heating zone selection control, the corresponding timer will be shown in the timer indicator.

Canceling the timer

1. Touching the heating zone selection control that you want to cancel the timer.



2. Touching the timer control, the indicator flash

3. Touch the slider control to set the timer to "00", the timer is cancelled

Using your Freestanding Cooker

Using the Time clock

1. Touch time clock control , the "10" will show in the timer display. and the "0" flashes.



2. Set the time by touching the slider control



3. Touch time clock control again, the "1" will flash.



4. set the time by touching the slider control , now the timer you set is 95 minutes. (You can set the timer up to 99 minutes.)

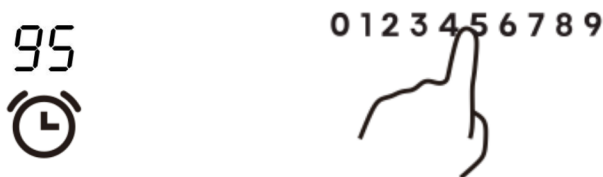

5. when the time is set, it will begin to count down immediately. The display will show the remaining time

6. buzzer will beep for 30 seconds and the timer indicator shows "- -" when the setting time finished.



7. it will not turn any cooking zone off when the set time is up.

Using your Freestanding Cooker

The oven light

Set cooking mode selection knob to symbol to switch on the oven light/s. The oven light/s stay on when the oven is operating.

General oven and cooking tips

The wire shelves should always be pushed firmly to the back of the oven.

Baking trays with food cooking on them should be placed level with the front edge of the oven's wire shelves. Other containers should be placed centrally. Keep all trays and containers away from the back of the oven, as over-browning of the food may occur.

When the oven is on, do not leave the door open for longer than necessary, otherwise the knobs may get very hot.

- Always leave 1cm gap between dishes on the same shelf. This allows the heat to circulate freely around them.
- To reduce fat splashing when you add vegetables to hot fat around a roast, dry them thoroughly or brush lightly with cooking oil.
- Where dishes may boil and spill over during cooking, place them on a baking tray.

Using your Freestanding Cooker

Practical Cooking Advice

The oven offers a wide range of alternatives which allow you to cook any type of food in the best possible way. With time you will learn to make the best use of this versatile cooking appliance and the following directions are only a guideline which may be varied according to your own personal experience.

Preheating

You should always preheat your oven before placing food in it to cook.

Once the food has been placed in the oven, the most appropriate cooking mode can then be selected.

Using the Grill

Use the grill mode  placing the food under the center of the grill (situated on the 3rd or 4th rack from the bottom) due to the central part of the top heating element being active.

Please use the grill pan set provided ensuring that there is no unwanted spillages formed inside your oven. When using this mode, we recommend you set the thermostat to the highest setting. However, this does not mean you cannot use lower temperatures, simply by adjusting the thermostat knob to the desired temperature.

When using this mode, we advise you to set the thermostat to 200°C, as it is the most efficient way to use the grill, which is based on the use of infrared rays.

Baking Cakes

When baking cakes, always place them in a preheated oven. Make sure you wait until the oven has been preheated thoroughly (the pilot lamp will turn off). To prevent cake from dropping/sinking - do not open the oven door during baking.

Pastry is too dry

Increase the temperature by 10°C and reduce the cooking time.

Pastry dropped

Use less liquid or lower the temperature by 10°C.

Pastry is too dark on top

Place it on a lower rack, lower the temperature, and increase the cooking time.

Using your Freestanding Cooker

Cooked well on the inside but sticky on the outside

Use less liquid, lower the temperature, and increase the cooking time.

The Pastry sticks to the pan

Grease the pan well and sprinkle it with a dusting of flour or use greaseproof paper.

Use a lower temperature setting. It is not necessary to remove the food from all the racks at the same time.

Cooking Fish and Meat

When cooking white meat, fowl and fish, use temperature setting from 180°C to 200°C.

For red meat that should be well done on the outside while tender and juicy in the inside, it is a good idea to start with a high temperature setting (200°C- 220°C) for a short time, then turn the oven down afterwards.

In general, the larger the roast, the lower the temperature setting. Place the meat on the center of the grid and place the dripping pan beneath it to catch the fat.

Make sure that the grid is inserted so that it is in the center of the oven. If you would like to increase the amount of heat from below, use the low rack heights. For savory roasts (especially duck and wild game), dress the meat with lard or bacon on the top.

Care and maintenance

Cleaning

WARNING! Isolate the power supply to the appliance and make sure that the cooker is cool.

Before cleaning your cooker or performing maintenance, make sure that the cooking mode selection knob and the cooking temperature selection knob is set to 'OFF'. To extend the life of your cooker, it must be cleaned frequently. The inside of the cooker should preferably be cleaned immediately after use, when it is still warm (but not hot, with warm water and soap. The soap should be rinsed away and the interior dried thoroughly. Avoid using abrasive detergents, scourers, acidic cleaners such as lime scale remover, etc, as these could damage the enamel, and can result in development of rust and corrosion. If stains are particularly tough to remove, use cleaners specifically recommended to clean cookers and follow the instructions provided with the cleaner.

Never use steam cleaner for cleaning inside the cooker.

Do not clean using caustic creams, abrasive cleaning powders, thick wire wool or hard tools. Enamelled parts of the cooker can be damaged if excess cleaning liquids are not immediately removed.

After cleaning the interior parts of the cooker with a soapy cloth, rinse it and then dry thoroughly with a soft cloth.

Clean the glass surfaces with special glass cleaning agents.

Never use flammable agents like acid, thinner or petrol when cleaning your appliance.

Clean the glass surfaces with special glass cleaning agents.

Do not clean your cooker with a steam cleaner.

Do not wash any part of your cooker in a dishwasher.

Enamelled Parts:

In order to keep enamelled parts as new, it is necessary to clean them frequently with mild warm soapy water and then dry with a cloth. Do not wash them while hot and never use abrasive powders or abrasive cleaning materials. Do not leave anything spilled onto enamelled parts for long periods of time.

Care and maintenance

Induction Glass:

The Induction glass should be regularly cleaned, always wipe clean immediately after each use once the residual heat warnings have switched off - DO NOT clean when hob is still hot. Smudges from pans with an aluminum bottom can be easily cleaned off with a cloth dampened in vinegar. Remove any burnt residues immediately after cooking, rinse with water and wipe dry with a clean cloth. Never use abrasive or corrosive detergents, cleaning powders, oven sprays, spot-removers, steel wool or scourers.

Replacing the oven lamps

- Disconnect the oven from the power supply at the fuse-box by means of the switch used to connect the appliance to the electrical mains ;or unplug the appliance.
- Remove the glass cover of the lamp-holder by rotating anti-clockwise.
- Remove the lamp and replace with a lamp resistant to high temperatures (300°C) with the following characteristics:

Voltage: 220-240V

Wattage: 25W

Type: G9

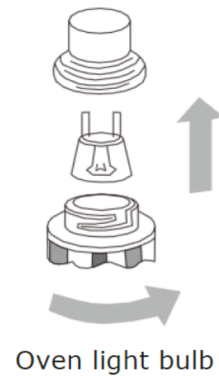

Replace the glass cover. Reconnect the appliance to the mains power supply.

Care and maintenance

Cleaning the oven door / How to remove the oven doors

Removing the doors

a. The oven door is fully open.

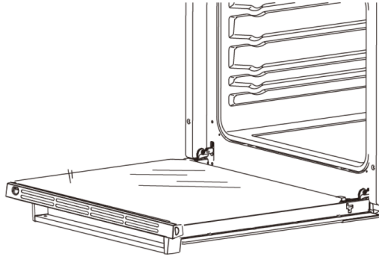

b. The latch hinges completely lifted.

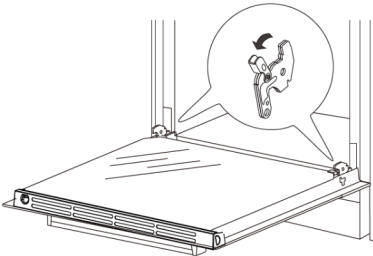

c. Gently close the oven door until you hear the sound of engagement, once they reach a clamping position, with both hands holding the door and continue to push, pull up at the same time so that the hinge bolt removed from the oven.

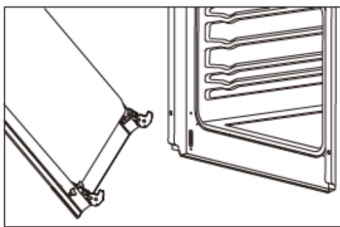
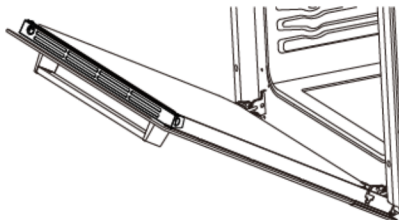

d. After cleaning, align the hinge with the oven door. Latch and push it until it catches. Take care to ensure that the hinge and door are properly

aligned to avoid door damage. If in doubt, contact the service centre - information is listed on the back of this user manual.

e. With the oven door fully opened, push the latch down to its initial position to complete the oven door installation.

Remove the inner glass panel

a. Press and hold the two sides of the grid with both hands to pull it out.

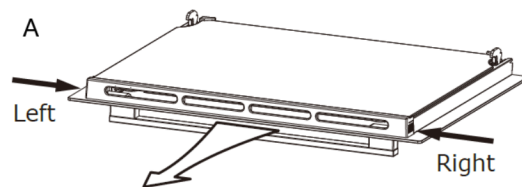

Pull out the grid

b. Remove the inner glass

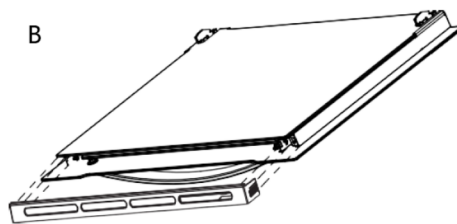

c. Locate the glass stopper and remove it. Remove the glass for cleaning. To reinstall the inner glass, simply gently place it back onto the door and reinsert the glass stopper to secure the glass in place.

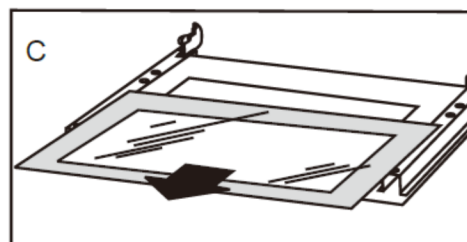

Technical Data

Technical specification

Cooking hob	60cm Induction Cooker
Hob Cooking Zones	4 Zones
Supply Voltage	220-240V~ 50/60Hz
Installed Electric Power	Max Total Power:11500W Hob:7200W Oven: Upper:1600W Lower:2700W
Product dimension	595 x 600 x 900mm

For future reference please record the following information which can be found on the rating plate and the date of purchase which can be found on your sales invoice. The rating plate is located on the backside of the appliance. Therefore it is a good idea to record this information before you install your appliance.

Technical Data

Energy fiche

Product fiche pursuant to Delegated Regulation(EU) No. 65/2014 and 66/2014		
Brand	Hisense	
Large Description	HDCEIT6C20B	
Product Line	FS Cooker with Double Oven	
Net weight(kg)	-	
Energy Efficiency Index, EEL Cav 1	86.8	
Energy Efficiency Index, EEL Cav 2	91.4	
Energy efficiency - cavity 1	A	
Energy efficiency - cavity 2	A	
Energy consumption conventional(kWh) - cavity 1	0.66	
Energy consumption conventional(kWh) - cavity 2	-	
Energy consumption forced air convection(kWh) - cavity 1	-	
Energy consumption forced air convection(kWh) - cavity 2	0.81	
Oven number	2	
Heat source	Electricity	
Cavity capacity(I) - cavity 1	50L	
Cavity capacity(I) - cavity 2	80L	
Power Consumption in standby mode	0.9W (with electric timer)	
Power Consumption in network stand-by mode	-	
Energy Saving Tips Oven	Energy Saving Tips Hob	
<ul style="list-style-type: none"> - Cook the meals together, if possible - Keep the pre-heating time short - Do not elongate cooking time - Do not forget to turn-off the oven at the end of cooking. - Do not open oven door during cooking period 	<ul style="list-style-type: none"> - Use cookwares having flat base - Use cookwares with proper size . - Use cookwares with lid. - Minimize the amount of liquid or fat. - When liquid starts boiling , reduce the setting. 	
Type of Hob		Electric
Number of Cooking Zones		4
Heating Technology-1		Induction
Size-1	cm	Ø18
Energy Consumption-1	Wh/kg	178.2
Heating Technology-2		Induction
Size-2	cm	Ø18
Energy Consumption-2	Wh/kg	179.6
Heating Technology-3		Induction
Size-3	cm	Ø21
Energy Consumption-3	Wh/kg	191
Heating Technology-4		Induction
Size-4	cm	Ø16
Energy Consumption-4	Wh/kg	187.3
Energy Consumption of Hob	Wh/kg	184
This hob complies with EN 60350-2		

Product support

Troubleshooting

If you have a problem with your appliance, check the troubleshooting table below to try and rectify your problem before calling your product support service centre.

Problem	Possible Cause	Solution
Oven will not operate	Control knob is not set in the correct position	Move the control knob In a clockwise direction and select the desired function
Nothing works	Power is turned off at the isolation switch or the consumer unit Poor electrical connection	Ensure isolation switch is on and check the consumer unit has not tripped out Have the connections been checked by a qualified electrician?
The cooking zones are not operating	Poor electrical connection Power is turned off at the isolation switch	Have the connections been checked by an electrician electrician? Ensure the isolation switch is on, check the consumer unit has not tripped out
Oven not heating up	Oven temperature not set correctly Door is not properly closed	Ensure that the correct temperature has been selected and the door is properly closed

Product support

Declaration of conformance to product standards

This appliance conforms to all relevant standards applicable to domestic appliances sold in the UK.

Disposal



This appliance/fitting is marked according to the European directive 2012/19/EU on Waste Electrical and Electronic Equipment (WEEE). By ensuring this product is disposed of correctly, you will help prevent potential negative consequences for the environment and human health,

which could otherwise be caused by inappropriate waste handling of this product.

The symbol on the product, or on the documents accompanying the product, the crossed out wheeled bin symbol, indicates that this appliance/fitting may not be treated as household waste. Instead it shall be handed over to the applicable collection point for the recycling of electrical and electronic equipment.

Disposal must be carried out in accordance with local environmental regulations for waste disposal.

For more detailed information about treatment, recovery and recycling of this product, please contact your local authority, your household waste disposal service or the retailer where you purchased the product.