

PPH 75P DF IX UK

12NC: F163547

GTIN (EAN) code: 5054645635474

Hotpoint

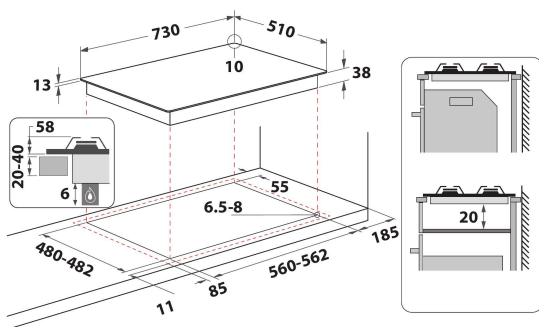

MAIN FEATURES

Product group	Hob
Construction type	Built-in
Type of control	Mechanical
Type of control settings	Knob
Number of gas burners	5
Number of electric cooking zones	0
Number of electric plates	0
Number of radiant plates	0
Number of halogen plates	0
Number of induction plates	0
Number of electric warming zones	0
Location of control panel	Front
Basic surface material	Inox
Main colour of product	Inox
Electrical connection rating (W)	0
Gas connection rating (W)	10600
Gas type	Methane
Current (A)	0
Voltage (V)	220-240
Frequency (Hz)	50/60
Length of Electrical Supply Cord (cm)	0
Plug type	UK
Gas connection	N/A
Width of the product	730
Height of the product	58
Depth of the product	510
Minimum niche height	0
Minimum niche width	560
Niche depth	480
Net weight (kg)	9.6
Automatic programmes	No

TECHNICAL FEATURES

Power on indicator	No
Number of indicators	0
Type of regulation	Rapid
Type of lid	Without
Residual heat indicator	Without
Main on/off switch	No
Safety device	No
Timer	No

PERFORMANCES

Energy input	Gas
--------------	-----