

# PHVP 82F LT K

12NC: F163946

GTIN (EAN) code: 5054645639465

**Hotpoint**

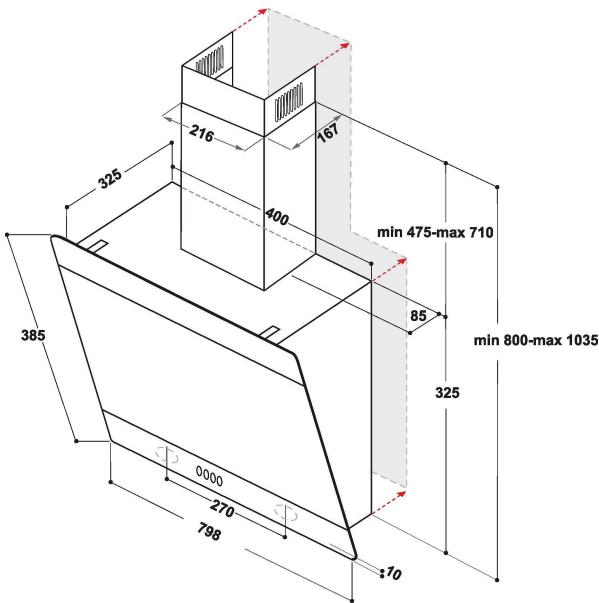

## MAIN FEATURES

Product group	Hood
Colour body	Black
Material body	Glass
Colour chimney	Black
Material chimney	Metal
Typology	Manual
Installation type	Free-standing
Type of control	Electronic
Type of control settings	-
Decor panel options	N/A
Motor location	Integrated motor in hood body
Operating Mode	Convertible
Electrical connection rating (W)	233
Current (A)	1,2
Voltage (V)	220-240
Frequency (Hz)	50
Length of Electrical Supply Cord (cm)	150
Plug type	UK
Chimney height (mm)	-
Height of product, without chimney (mm)	325
Height of the product	360
Width of the product	798
Depth of the product	326
Minimum niche height	0
Minimum niche width	0
Niche depth	0
Net weight (kg)	14

## TECHNICAL FEATURES

Type of manual control devices	Touch control
Type of automatic control devices	-
Number of motors	1
Total power of the motors (W)	230
Number of speed settings: boost option availability	4
Boost presence	Yes
Maximum output air extraction (m <sup>3</sup> /h)	495
Boost position air extraction (m <sup>3</sup> /h)	650
Maximum output recirculating air (m <sup>3</sup> /h)	470
Boost position output recirculating (m <sup>3</sup> /h)	580
Light Control Type	On/Off
Number of lights	2
Type of lamps used	LED
Total power of the lamps (W)	3
Diameter of air outlet (mm)	150
No-return airflow flap	Yes
Grease filter material	Washable aluminium
Odour filter	Yes

## PERFORMANCES

Sound power at min. speed (2010/30/EU)	52
Sound power at max. speed (2010/30/EU)	65
Noise level with boost position (dB(A) re 1 pW)	71