

# Hygena Alena Wooden Spacesaver

Assembly Instructions - Please keep for future reference

4259156

4284592

**hygena**

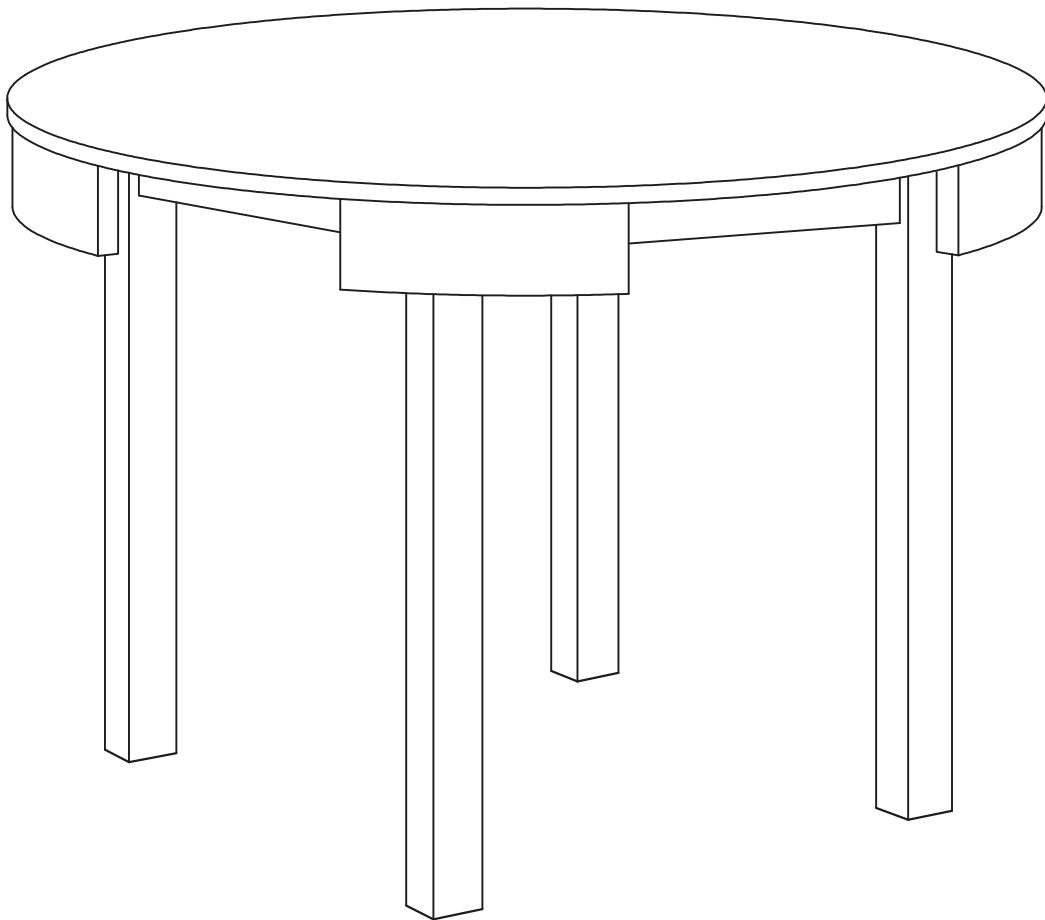

## Dimensions

Width - 105cm

Depth - 105cm

Height - 75.4cm

**Important - Please read these instructions fully before starting assembly**

If you need help or have damaged or missing parts, call the **Customer Helpline: 0345 640 0800**



# Safety and Care Advice

**Important** - Please read these instructions fully before starting assembly

- Check you have all the components and tools listed on the page 2.
- Remove all fittings from the plastic bags and separate them into their groups.
- Keep children and animals away from the work area, small parts could choke if swallowed.
- Make sure you have enough space to layout the parts before starting.
- During assembly do not stand or put weight on the product, this could cause damage.
- Assemble the item as close to its final position (in the same room) as possible.
- Assemble on a soft level surface to avoid damaging the unit or your floor.
- Parts of the assembly will be easier with 2 people.

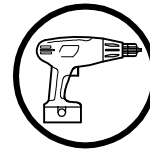

power drill is set on a low torque setting.

- To reduce the likelihood of damaging your product please ensure that your

## Care and maintenance

- Only clean using a damp cloth and mild detergent, do not use bleach or abrasive cleaners.
- From time to time check that there are no loose screws on this unit.
- This product should not be discarded with household waste. Take to your local authority waste disposal centre.

## Handy Hints

- Assemble all parts and bolts loosely during assembly, only once the product is complete should you fully tighten the bolts
- Regularly check and ensure that all bolts and fittings are tightened properly.

**Note:** if required the next page can be cut out and used as reference throughout the assembly. Keep this page with these instructions for future reference.

# Components - Panels

If you have damaged or missing components,  
call the Customer Helpline: 0345 640800

Please check you have all the fittings listed below

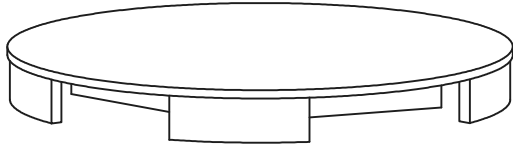

**1** Table Top  
(105 x 105)cm

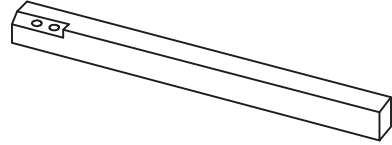



**2** Table Leg x 4  
(73.5 x 4.5)cm

# Components - Fittings

Please check you have all the fittings listed below

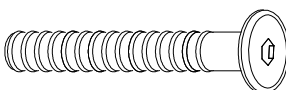
**Note:** The quantities below are the correct amount to complete the assembly for one table. In some cases more fittings may be supplied than are required.

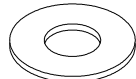
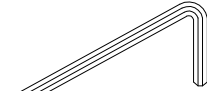
|  |  |  |
|--|--|--|
| <b>A</b><br><br>60mm Bolt x 8 | <b>B</b><br><br>Spring Washer x 8 | <b>C</b><br><br>Flat Washer x 8 |
| <b>D</b><br><br>Allen Key x 1 |  |  |

Tools required

Ruler - Use this ruler to help correctly identify screws.

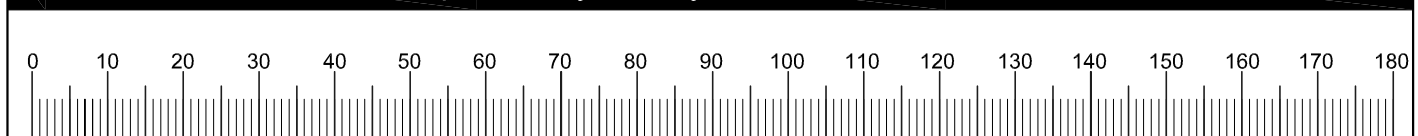

# Assembly Instructions

## Step 1

### Table Leg

Locate the table leg **2**  
at 4 corner of table top **1**

Assemble Bolt **A**, Spring Washers **B** and Flat Washer **C** through corner block using Allen key **D**.

Tighten the bolts, and repeat for all legs.

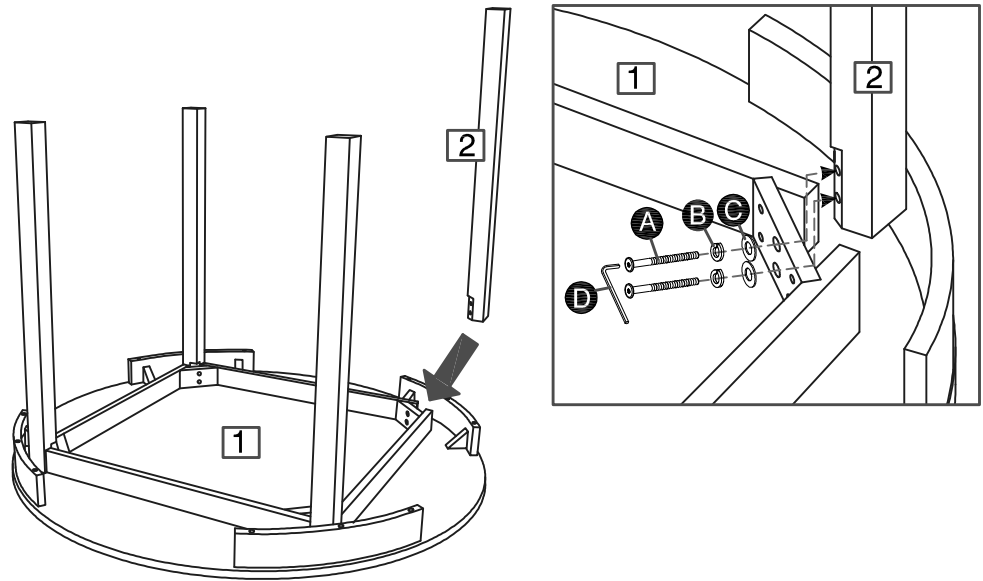

## Step 2

Carefully turn the table over, and put the table on the floor.

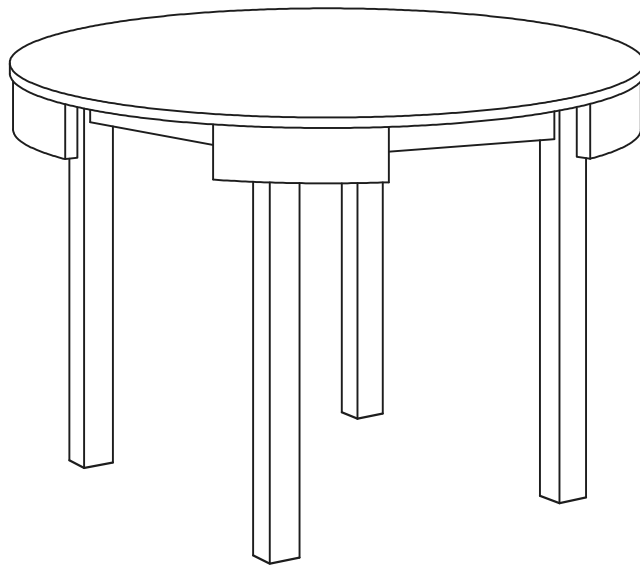

Assembly is complete.

If you need help or have damaged or missing parts, call the Customer Helpline: 0345 6400800