

# Heat Pump Dryer

User manual

DV\*\*CGC2\*\*\*\* / DV\*\*CGC0\*\*\*\*



**SAMSUNG**



# Contents

---

## Safety information 4

---

What you need to know about the safety instructions	4
Important safety symbols	4
Important safety precautions	5
Critical installation warnings	8
Critical usage warnings	9
Usage cautions	10
Critical cleaning warnings	11
Care for preventing freezing	11
Instructions about the WEEE	12

## Installation 13

---

What's included	13
Installation requirements	15
Step-by-step installation	16
Door reversal	20
Environment	24

## Operations 25

---

Control panel	25
Getting started	31
Special features	33

## Maintenance 37

---

Emptying the water tank (  )	37
Cleaning	38

## Troubleshooting 43

---

Checkpoints	43
Information codes	44





---

<b>Appendix</b>	<b>46</b>
Fabric care chart	46
Protecting the environment	47
Specification	48
Consumption data	49
Specification sheet	50
<b>Contact information</b>	<b>52</b>
QUESTIONS OR COMMENTS?	52





# Safety information

Congratulations on your new Samsung dryer. This manual contains important information on the installation, use, and care of your appliance. Please take the time to read this manual to take full advantage of your dryer's many benefits and features.

## What you need to know about the safety instructions

Warnings and Important Safety Instructions in this manual do not cover all possible conditions and situations that may occur. It is your responsibility to caution and care when installing, maintaining, or operating your dryer.

Always contact your manufacturer about problems or conditions you do not understand.

## Important safety symbols

What the icons and signs in this user manual mean:

### **WARNING**

Hazards or unsafe practices that may result in severe personal injury, death and/or property damage.

### **CAUTION**

Hazards or unsafe practices that may result in personal injury and/or property damage.

### **NOTE**

Indicates that a risk of personal injury or material damage exists.

### **Read the instructions**

**These warning signs are here to prevent injury to yourself and others.**

**Please follow them explicitly.**

**After reading this manual, store it in a safe place for future reference.**

Read all instructions before using the appliance.

As with any equipment that uses electricity and moving parts, potential hazards exist. To safely operate this appliance, familiarize yourself with its operation and exercise care when using it.

## **WARNING**

### **Risk of Fire**

- Clothes dryer installation must be performed by a qualified technician.
- Install the clothes dryer according to the manufacturer's instructions and local codes.
- To reduce the risk of severe injury or death, follow all installation instructions.







---

## Important safety precautions

---

### **WARNING**

**To reduce the risk of fire, electric shock, or injury to persons when using your appliance, follow basic precautions, including the following:**

1. This appliance is not to be used by persons (including children) with reduced physical, sensory or mental capabilities, or lack of experience and knowledge, unless they have been given supervision or instruction concerning use of the appliance by a person responsible for their safety.
2. **For use in Europe:** This appliance can be used by children aged from 8 years and above and persons with reduced physical, sensory or mental capabilities or lack of experience and knowledge if they have been given supervision or instruction concerning use of the appliance in a safe way and understand the hazards involved. Children shall not play with the appliance. Cleaning and user maintenance shall not be made by children without supervision.
3. Children should be supervised to ensure that they do not play with the appliance.
4. If the supply cord is damaged, it must be replaced by the manufacturer, its service agent or similarly qualified persons in order to avoid a hazard.
5. For appliances with ventilation openings at the base, make sure that items such as carpets or mats do not obstruct the openings.



## Safety information

---

6. **For use in Europe:** Children of less than 3 years should be kept away unless continuously supervised.
7. **CAUTION:** In order to avoid a hazard due to inadvertent resetting of the thermal cut-out, this appliance must not be electrical connected through an external switching device, such as a timer, or connected to a circuit that is regularly switched on and off by the utility.
8. The tumble dryer is not to be used if industrial chemicals have been used for cleaning.
9. The lint trap has to be cleaned frequently if applicable.
10. Lint must not to be allowed to accumulate around the tumble dryer. (not applicable for appliances intended to be vented to the exterior of the building)
11. Adequate ventilation has to be provided to avoid the back flow of gases into the room from appliances burning other fuels, including open fires.
12. Do not dry unwashed items in the tumble dryer.
13. Items that have been soiled with substances such as cooking oil, acetone, alcohol, petrol, kerosene, spot removers, turpentine, waxes and wax removers should be washed in hot water with an extra amount of detergent before being dried in the tumble dryer.
14. Items such as foam rubber (latex foam), shower caps, waterproof textiles, rubber backed articles and clothes or pillows fitted with foam rubber pads should not be dried in the tumble dryer.

- 
15. The final part of a tumble dryer cycle occurs without heat (cool down cycle) to ensure that the items are left at a temperature that ensures such items will not be damaged.
  16. Remove all objects from pockets such as lighters and matches.
  17. **WARNING:** Never stop a tumble dryer before the end of the drying cycle unless all items are quickly removed and spread out so that the heat is dissipated.
  18. Exhaust air must not be discharged into a flue which is used for exhausting fumes from appliances burning gas or other fuels.
  19. The appliance must not be installed behind a lockable door, a sliding door or a door with a hinge on the opposite side to that of the tumble dryer, in such a way that a full opening of the tumble dryer door is restricted.
  20. **WARNING:** The appliance must not be supplied through an external switching device, such as a timer, or connected to a circuit that is regularly switched on and off by a utility.
  21. Fabric softeners, or similar products, should be used as specified by the fabric softener instructions.
  22. **WARNING:** In the appliance enclosure or in the built-in structure, keep ventilation openings clear of obstruction.
  23. **WARNING:** Do not damage the refrigerant circuit.



# Safety information

---

## Critical installation warnings

---

### WARNING

The installation of this appliance must be performed by a qualified technician or service company.

- Failure to do so may result in electric shock, fire, an explosion, problems with the product, or injury.

Plug the power cord into a wall socket and use the socket for this appliance only. In addition, do not use an extension cord.

- Sharing a wall socket with other appliances using a power strip or extending the power cord may result in electric shock or fire.
- Ensure that the power voltage, frequency and current are the same as those of the product specifications. Failure to do so may result in electric shock or fire. Failure Plug the power plug into the wall socket firmly.

Remove all foreign substances such as dust or water from the power plug terminals and contact points using a dry cloth on a regular basis.

- Unplug the power plug and clean it with a dry cloth.
- Failure to do so may result in electric shock or fire.

Keep all packaging materials well out of the reach of children, as packaging materials can be dangerous to children.

- If a child places a bag over its head, it may result in suffocation.

This appliance must be properly grounded.

Do not ground the appliance to a gas pipe, plastic water pipe, or telephone line.

- This may result in electric shock, fire, an explosion, or problems with the product
- Never plug the power cord into a socket that is not grounded correctly and make sure that it is in accordance with local and national codes.

Do not install or keep the product exposed to the outdoor elements.

Do not use a damaged power plug, damaged power cord or loose wall socket.

- This may result in electric shock or fire.

If the plug (power supply cord) is damaged, it must be replaced by the manufacturer, its service agent or a similar qualified technician in order to avoid a hazard.

This appliance should be positioned to be accessible to the power plug after installation.

Do not pull or excessively bend the power cord.

Do not twist or tie the power cord.

Do not hook the power cord over a metal object, place a heavy object on the power cord, insert the power cord between objects, or push the power cord into the space behind the appliance.

- This may result in electric shock or fire.

Do not pull the power cord, when unplugging the power plug.

- Unplug the power plug by holding the plug.
- Failure to do so may result in electric shock or fire.



This appliance must be properly grounded. Never plug the power cord into a receptacle that is not grounded adequately and in accordance with local and national codes. See installation instructions for grounding this appliance.

Install this appliance in a location with solid, level floor.

- Failing to do so may result in abnormal vibrations, noise or problems with the product.

Since an ingredient in hair spray may degrade the hydrophile property of the heat exchanger so that dew may appear on the outer surface of the appliance when the cooling operation is running, do not install the appliance in a beauty salon.

This appliance should be positioned so that the power plug, the water supply taps, and the drain pipes are accessible.

## Critical usage warnings

### WARNING

Do not let children or pets on or into the product. In addition, when disposing of this product, disassemble the door lock (lever).

- This may result in children falling and injuring themselves.
- If children become locked in the product, there is a danger of suffocation.

Do not try to access the inside of the product when the drum is rotating.

Do not sit on the product or lean against the door.

- This may result in the product turning over and resulting in injury.

Dry the laundry only after it was spun by an appropriate washing machine.

Do not dry unwashed items in the tumble dryer.

Do not drink the condensed water.

Never stop a tumble dryer before the end of the drying cycle unless all items are quickly removed and spread out so that the heat is dissipated.

Do not dry laundry contaminated by inflammable materials such as gasoline, kerosene, benzene, thinner, alcohol, etc.

- This may result in electric shock, fire or explosion.

Do not let pets chew or play with the dryer.

- This may result in electric shock or injury.

When disposing of the product, separate the door and the power cord before disposing of the product.

- Failing to do so may result in damage to the power cord or an injury.

Do not touch the power plug with wet hands.

- This may result in electric shock.

When gas (city gas, propane gas, LP gas) leaks, do not touch this appliance or the power cord, ventilate immediately.

- Do not use an electric fan to ventilate.
- A spark may cause an explosion or fire.



# Safety information

---

Do not repair, replace, or attempt to service any part of the appliance unless specifically recommended in the user-repair instructions. You must also have the necessary skills to service this appliance.

Do not attempt to repair, disassemble, or modify the appliance yourself.

- Do not use any fuse (such as copper, steel wire, etc.) other than the standard fuse.
- When repairing or reinstalling the appliance is required, contact your nearest service center.
- Failure to do so may result in electric shock, fire, problems with the product, or injury.

The product you have purchased is designed for domestic use only.

The use for business purposes qualifies as product misuse. In this case, the product will not be covered by the standard warranty provided by Samsung and no responsibility can be attributed to Samsung for malfunctions or damages resulting from such misuse.

If the product generates strange noise, smells of something burning, or generates smoke, immediately cutoff the power and contact the service center.

- Otherwise, it may cause an electric shock or fire as a result.

Do not let children (or pets) play in or on your product. The product door does not open easily from the inside and children may be seriously injured if trapped inside.

## Usage cautions

---

### CAUTION

Do not stand on top of the appliance or place objects (such as laundry, lighted candles, lighted cigarettes, dishes, chemicals, metal objects, etc.) on the appliance.

- This may result in electric shock, fire, problems with the product, or injury.

Do not touch the glass door and inside of the drum during or just after drying as it is hot.

- This may result in burns.

The door glass becomes hot during drying. Therefore, do not touch the door glass.

Also, do not allow children to play around the dryer or touch the door glass.

- This may result in burns.

Do not press the buttons using sharp objects such as pins, knives, fingernails, etc.

- This may result in electric shock or injury.

Do not dry laundry containing forming rubber such as latex or similar rubber textures.

- If forming rubber is heated, it may deform or start a fire.

Do not dry laundry contaminated by vegetable oil or cooking oil as a large amount of the oil will not be removed when washing the laundry. In addition, use the unheated dry cycle so that the laundry is not heated.

- The oxidization heat of the oil may start a fire.

Do not dry laundry contaminated by foreign substances such as oil, cream, lotion, or other chemicals that are used in places such as skincare room, massage parlor, beauty salon, or hospital.

- This may result in electric shock, fire, malfunction, and injury.



Make sure that the pockets of all clothing to be dried are empty.

- Hard, sharp objects, such as coins, safety pins, nails, screws, or stones can cause extensive damage to the appliance.

Do not dry clothing with large buckles, buttons, or other heavy metal (zippers, hooks and eyelets, button-up covers).

If necessary, use the laundry net for small and lightweight laundry such as fabric tie belt, apron strings, and underwire bras which can dissolve or break during a cycle.

Dryer sheets are compatible with this model, and are recommended for better drying performance.

Dryer sheets are also beneficial in reducing the static electricity generated during a drying cycle. Static electricity could lead to damage of laundry items and potentially the appliance.

Do not use the dryer near dangerous powders such as coal dust, wheat flour, etc.

- This may result in electric shock, fire or an explosion.

Do not place inflammable materials near the product.

- This may result in toxic gases from the product, damage to parts, electric shock, fire or an explosion.
- The appliance should not be placed behind lockable doors etc.

Do not touch the rear side of the appliance during or immediately after drying is complete.

- The appliance remains hot and may cause burns.

## Critical cleaning warnings

### WARNING

Do not clean the appliance by spraying water directly onto it.

Do not use benzene, thinner or alcohol to clean the appliance.

- This may result in discoloration, deformation, damage, electric shock or fire.

Before cleaning or performing maintenance, unplug the appliance from the wall socket.

- Failure to do so may result in electric shock or fire.

Clean the filter case before and after using the dryer.

Clean the inside of the product on a regular basis by asking an authorized service engineer.

Clean the Heat Exchanger with a soft brush or vacuum cleaner once a month, Do not touch the heat exchanger with your hand, there is a danger it may cause an injury.

The interior of the dryer should be cleaned periodically by qualified service personnel.

## Care for preventing freezing

- Install the dryer in an area where the temperature does not drop below zero degree Celsius.
- If draining directly using a long drain hose, the water remaining inside the hose can freeze in winter. Make sure there is no water left inside the hose after every use.
- If the drain hose has frozen up, wrap the hose with a towel soaked in warm water for approximately ten minutes to thaw it.

# Safety information

## Instructions about the WEEE



### Correct Disposal of This Product (Waste Electrical & Electronic Equipment)

(Applicable in countries with separate collection systems)

This marking on the product, accessories or literature indicates that the product and its electronic accessories (e.g. charger, headset, USB cable) should not be disposed of with other household waste at the end of their working life. To prevent possible harm to the environment or human health from uncontrolled waste disposal, please separate these items from other types of waste and recycle them responsibly to promote the sustainable reuse of material resources.

Household users should contact either the retailer where they purchased this product, or their local government office, for details of where and how they can take these items for environmentally safe recycling.

Business users should contact their supplier and check the terms and conditions of the purchase contract. This product and its electronic accessories should not be mixed with other commercial wastes for disposal.

For information on Samsung's environmental commitments and product regulatory obligations, e.g. REACH, WEEE or Batteries, visit our sustainability page available via [www.samsung.com](http://www.samsung.com)



# Installation

## What's included

Carefully unpack the dryer. Keep all packaging materials away from children. The parts and location of parts shown below may differ from your dryer. Before installation, make sure the dryer has all the parts listed here. If the dryer and/or parts are damaged or missing, contact the nearest Samsung customer service center.

## Dryer at a glance

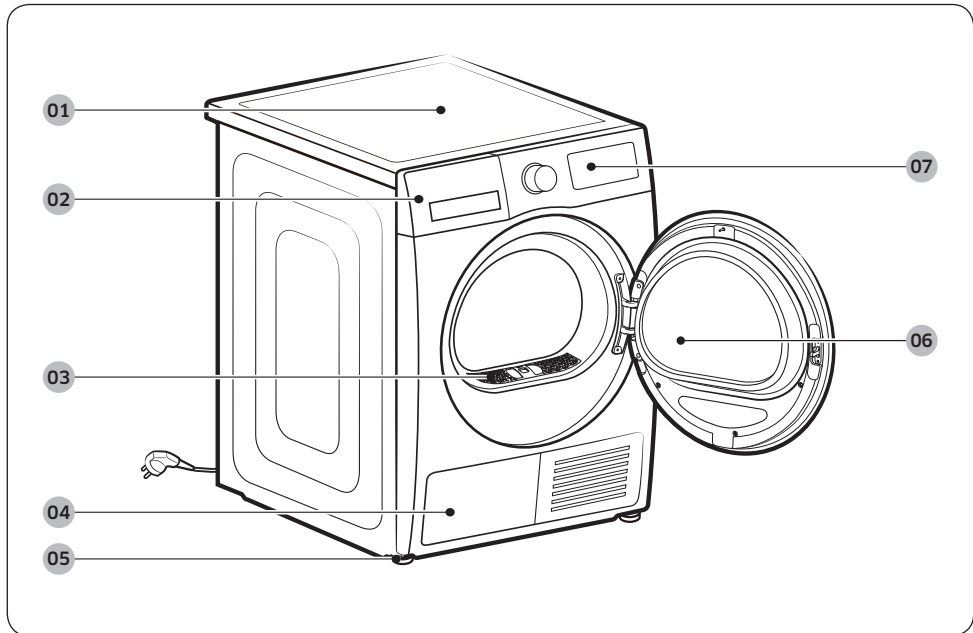

01 Top cover

02 Water Tank

03 Lint filter

04 Heat exchanger

05 Levelling Leg

06 Door

07 Control Panel

# Installation

## Accessories (supplied)

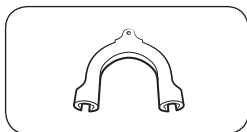

Hose guide

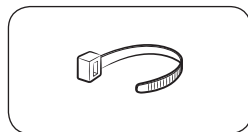

Cable tie

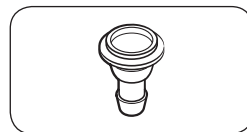

Hose connector

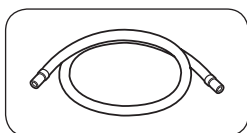

Long drain hose (2 m)

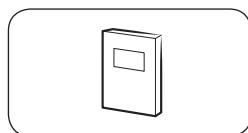

User manual

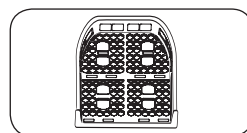

Rack Dry (applicable models only)

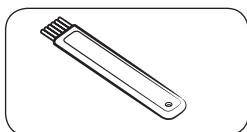

Cleaning brush

## Accessories (not supplied)

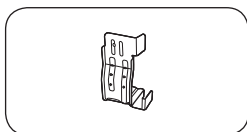

Bracket-Stacking kit  
(SK-DH, SK-DA, SKK-DF)

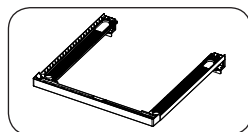

Stacking kit  
(SKK-5E\*)

### NOTE

- The stacking kit allows the dryer to be stacked on top of a washer. Please note that the stacking kit can only be used with Samsung washers and dryers. To purchase a bracket stacking kit (SK-DH, SK-DA, SKK-DF) or stacking kit (SKKDD, SKK-DDX), contact a Samsung service centre or local appliance retailer. The stacking kit differs with the washer model.
- For stacking instructions with the dryer, see the installation manual included in the stacking kit.
- For information about model-specific availability of the stacking kit, see the installation manual included in the stacking kit.

## Installation requirements

### NOTE

This dryer must be installed by a qualified installer. If service is required due to poor or faulty installation, it is considered the owner's responsibility and may void the warranty. Keep these instructions for future reference.

### WARNING

- Do not plug the power cord into a wall outlet before the dryer is completely installed.
- Have two or more persons help move the dryer.
- Do not let children or pets play in, on, or around the dryer. Proper supervision is necessary at all times.
- Keep all packaging materials away from children.
- Do not replace a damaged power cord or power plug yourself. Have Samsung or a qualified service technician replace a damaged power cord or power plug.
- Do not attempt to repair, disassemble, or modify the dryer. For any repairs, contact the nearest Samsung service center.
- Remove the door/lids from all discarded appliances to avoid children from suffocating.
- If the dryer generates a strange noise, burning smells, or smoke, unplug the power plug immediately and contact the nearest Samsung service center.
- Do not unplug the dryer while it is operating.
- Do not place flammable objects near the dryer.

### Electrical and grounding requirements

- The dryer must be properly grounded. If the dryer malfunctions or breaks down, grounding reduces the risk of electric shock by providing a path of least resistance for the electric current. The dryer comes with a power cord that has a 3-prong grounding plug. The plug must be plugged into an appropriate outlet that is properly installed and grounded in accordance with all local codes and ordinances.
- If you have any questions regarding the electrical or grounding requirements, please contact Samsung or a qualified electrician.

### WARNING

- Plug the power cord into a grounded, 3-prong outlet.
- Do not use a damaged power plug, cord, or loose or damaged wall outlet.
- Do not use an adapter or an extension cord.
- Improper connection of the equipment-grounding conductor may result in electric shock. If you are unsure if the dryer is properly grounded, check with a qualified electrician.
- Do not modify the power plug, power cord, or power outlet in any way.
- Do not connect the ground wire to plastic plumbing lines, gas lines, or hot water pipes.



# Installation

## Alcove or closet installation

For alcove or closet installation, the dryer requires the following minimum clearances:

Sides	Top	Front	Rear
25 mm	25 mm	490 mm	50 mm

If installing the dryer with a washing machine, the front of the alcove or closet must have an unobstructed air opening of at least 490 mm.

## Step-by-step installation

Before you install your dryer, make sure you have read **Installation requirements** on page 15.

### STEP 1 Select a location

#### Location requirements

Select a level, well-constructed surface that will withstand vibrations. Select a location where a grounded, 3-prong outlet is easily accessible.

For convenience, consider installing the dryer next to your washing machine.

#### WARNING

- Install the dryer indoors only.
- Do not install the dryer in areas exposed to the weather.
- The ambient temperature for installation is 5~35°C.
  - If the ambient temperature is low enough to freeze the condensed water in the dryer and hoses, the dryer may not operate, or can be damaged.
  - Make sure that the temperature where the dryer is installed is not outside the recommended temperature range. Drying performance may be reduced.
  - Make sure not to install the dryer in an enclosed environment or near any heat producing appliances.
- Do not install the dryer where gas may leak.
- Do not use in a poorly ventilated space or area.
- Use only a power source connected to the wall.



## STEP 2 Adjust the levelling feet

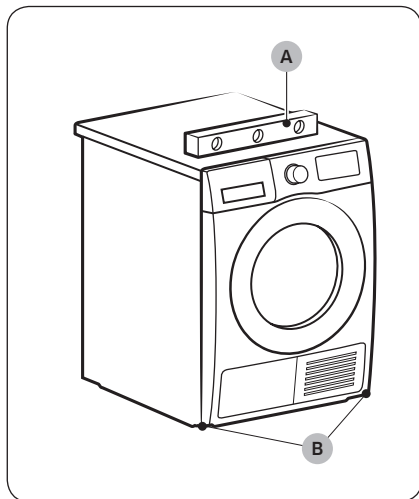

1. Gently slide the dryer into the desired location.
2. Use a **level (A)** and check the levelness of the dryer from side to side and front to back.
3. If the dryer is not level, turn the **levelling feet (B)** left or right to adjust the height.
4. Once the dryer is level, make sure the dryer stands firmly on the floor.
5. Plug in the dryer.

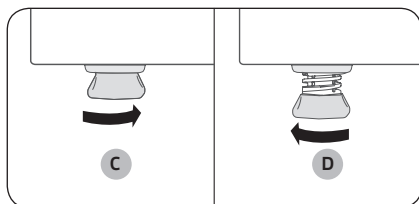

### NOTE

- To set the dryer to the same height as the washing machine, turn the levelling feet to the right until it fully **retracts (C)**. Then, turn the levelling feet to the left to **extend (D)** it until the dryer and the washing machine are the same height.
- Extend the levelling leg only as much as necessary. Extending the levelling leg more than necessary can cause the dryer to vibrate.

# Installation

## STEP 3 Connect the drain hose

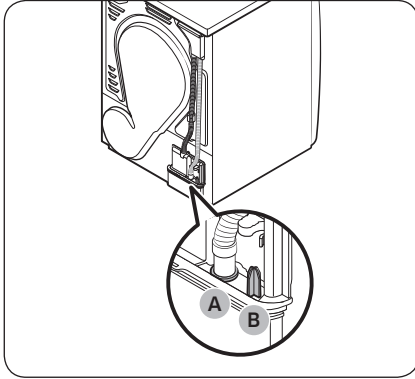

- We strongly recommend connecting the drain hose to your drainage system.
- If the drain hose connected on the dryer is too short to reach the drainage system, use the provided accessory hose (long drain hose).
- Use the built-in water tank only if you cannot connect the drain hose to a drainage system.

### NOTE

As a factory default, this dryer is set to use the built-in water tank to drain condensed water.

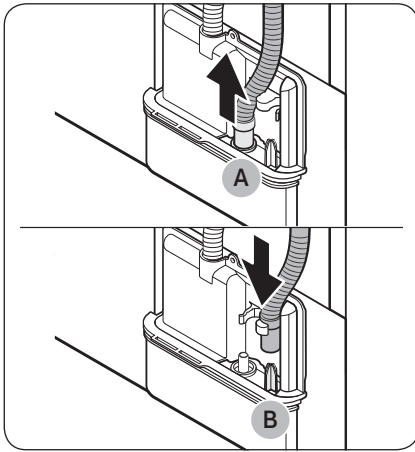

1. Remove the drain hose from **hole (A)**, and insert it into **part (B)**.

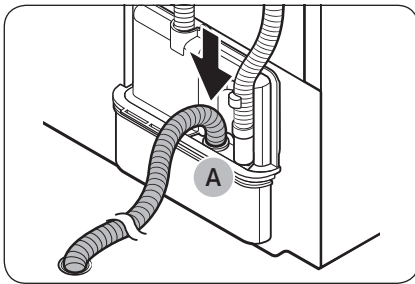

2. Insert one end of the accessory hose (long drain hose) into **hole (A)**.
3. Insert the other end (outlet) of the accessory hose to the drainage system in one of the following ways:

### Over a wash basin:

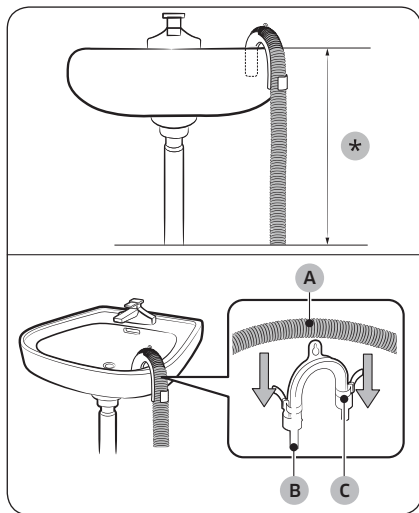

1. Make sure to place the end of the accessory hose lower than **90 cm (\*)** from the bottom of dryer.
2. To bend some point of the accessory hose, use the supplied plastic **hose guide (B)** and secure the guide to the wall with a hook or to the tap with a piece of string. Assemble the **drain hose (A)** and the **hose guide (B)** and fix them with the  **cable-tie (C)**.
3. You can drain the condensed water by connecting the accessory hose (long drain hose) to the drainoutlet directly.

#### ⚠ CAUTION

Do not extend the drain hose. Water may leak from the connected area. Use a long drain hose.

### By using the drain pipe of the wash basin:

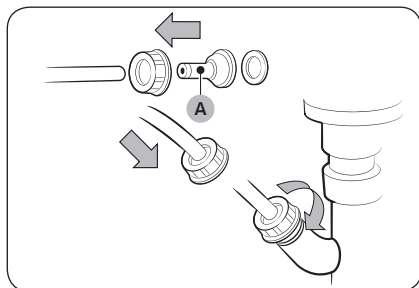

1. Assemble the **hose connector (A)**, and attach it to the end of the accessory hose as shown.

#### ⚠ CAUTION

To prevent water leak, make sure to connect the hose and the connector firmly.



2. Connect the hose adapter directly to the drain pipe of the wash basin.



# Installation

## STEP 4 Check the installation

- All packaging material is completely removed and properly disposed.
- The dryer is level and standing firmly on the floor.
- Make sure no accessory remains inside the drum.
- Do not block the air inlet hole of the cooling grill at the front of the dryer.
- Do not place inflammable objects near the dryer and keep the surroundings clean.
- Do not remove the adjustable levelling legs of the dryer. They are necessary to keep the dryer level with the ground.
- After installation, we recommend that you wait at least 1 hour before using the dryer.

## STEP 5 Power on

Plug the power cord into a wall socket protected by a fuse or circuit breaker. Then, tap  to turn on the dryer.

### NOTE

Run the Time Dry cycle for 20 minutes to make sure that it runs, heats, and shuts off. If the **HC** information code is displayed, contact a local service center.

## Door reversal

You might want to reverse the direction of the door, depending on your site conditions or to your needs.

### WARNING

Make sure door reversal is performed by a qualified technician.

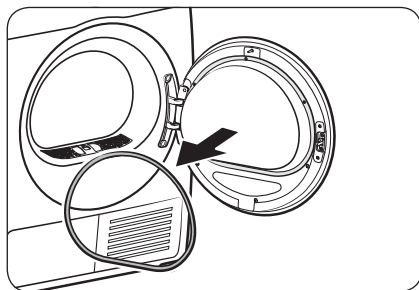

1. Remove the door packing from the door.





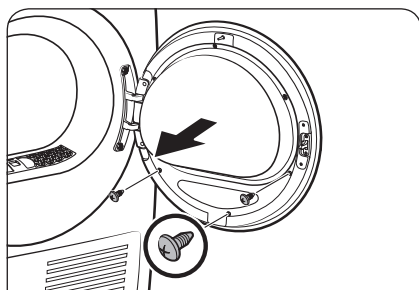

2. Remove the screws on the inner glass holder of the door.
- First, loosen and remove the 3 screws on the bottom. Then, loosen and remove the 3 screws on the top of the holder.

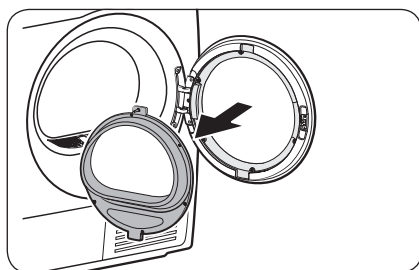
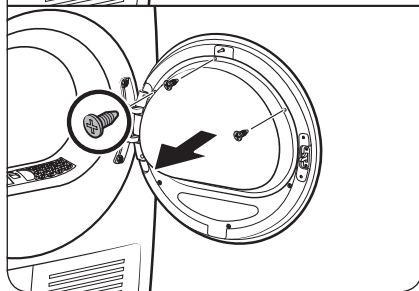

3. Detach the glass holder.

**⚠ CAUTION**

Use caution not to drop any part of the holder when detaching it. Property damage (cracks or breaks) or physical injury may occur.

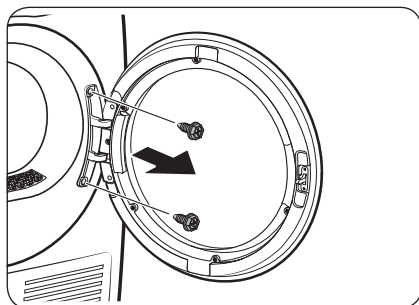

4. Remove the hinge screws, and then detach the door.
- Loosen and remove the 2 bolts on the door frame.
  - To prevent abrasion on the bolts, use a hex screwdriver.

# Installation

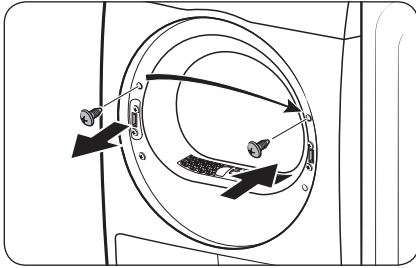

5. Remove the upper screw on the left of the door frame, and then insert it in the corresponding right hole of the door frame. Do not remove the lower bracket screws.

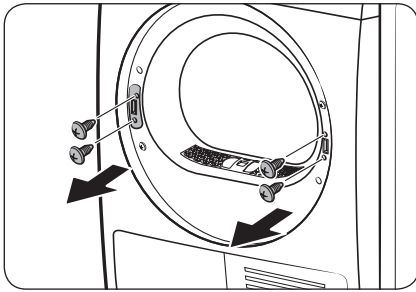

6. Remove the 2 bracket screws on the right frame, and then remove the 2 holder screws on the left frame.

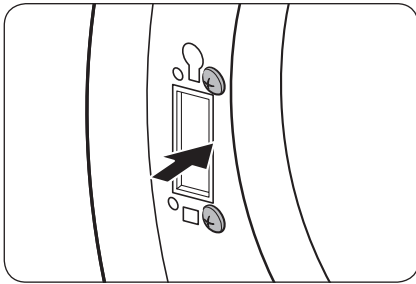

7. Insert the 2 removed bracket screws in the left frame as shown.
  - See the figure on the right for the correct position of the screws.

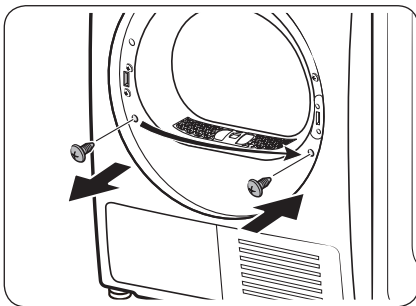

8. Remove the bottom screw on the left frame, and then insert it in the corresponding hole on the right frame.

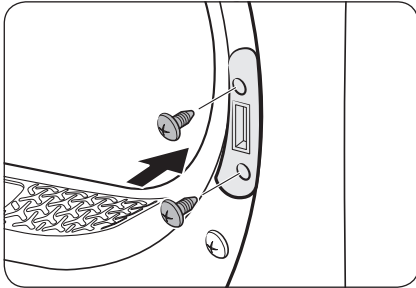

9. Insert the lever holder on the right frame, and then tighten the 2 holder screws.

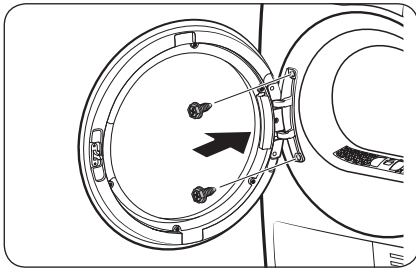

10. Insert the door hinge in the opposite position of the door frame, and then, tighten the 2 bolt screws.

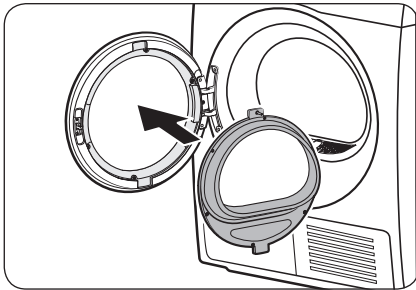

11. Insert the inner glass holder in the door cover that has been installed on the left frame.

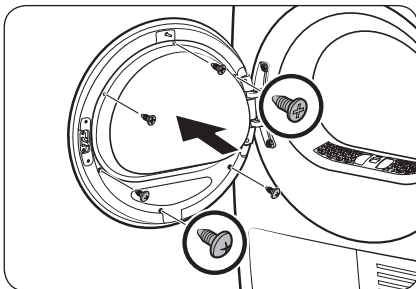

12. Tighten the 3 holder screws on the top. Then, tighten the 3 holder screws on the bottom.



# Installation

---

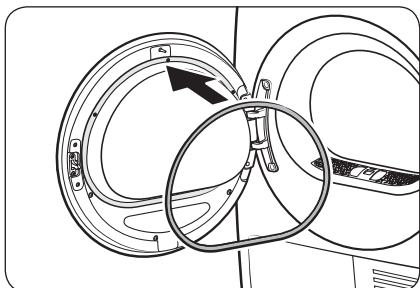

13. Attach the door packing to the door.

## NOTE

To return the door to the initial position, follow the steps again. Please note that the door, hinges, and other parts would be in the opposite orientation as listed in these steps.

## Environment

---

Please dispose of the packaging materials for this product in an “environmentally friendly” manner. For further detail, please contact your local area authority.



# Operations

## Control panel

DV\*\*CGC2\*\*\*\*

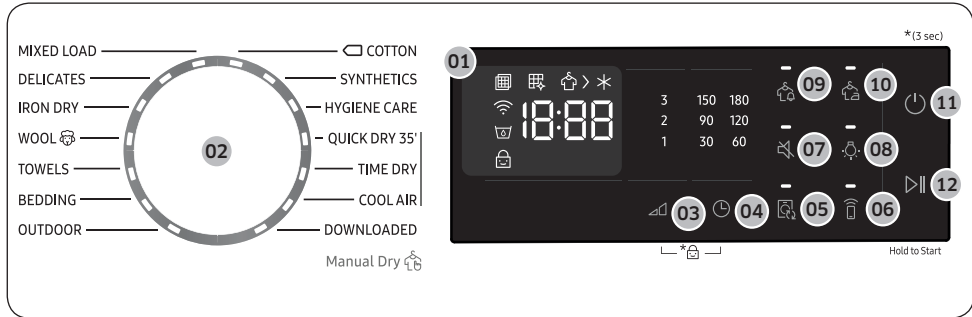



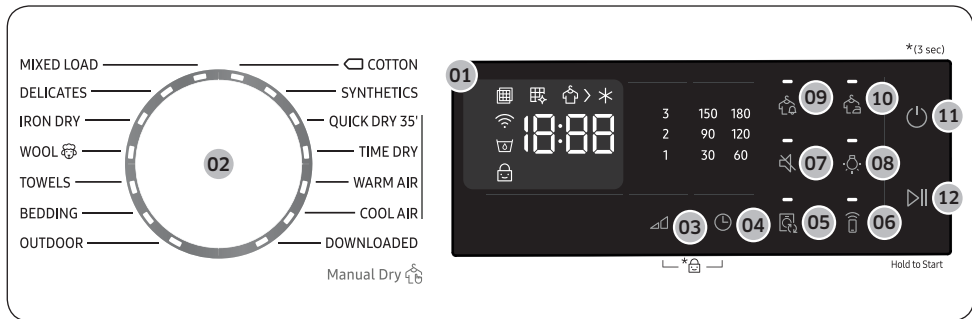







DV\*\*CGC0\*\*\*\*









<b>01 Digital Graphic Display</b>	Displays all cycle information, including cycle time, information codes, and dryer status.
<b>02 Cycle Selector</b>	Turn the dial to select a cycle. See the <b>Cycle overview</b> on page 27 for available cycles.
<b>03  Dry Level</b>	Press to select the dryness level in the <b>COTTON</b> , <b>MIXED LOAD</b> , and <b>SYNTHETICS</b> cycles. The dryness can be set in three levels (1-3). Level 1 is used to partially dry items that lay flat or hang to dry. Level 3 is the strongest and is used to dry larger or bulk loads.
<b>04  Time</b>	Press to adjust the cycle time for <b>TIME DRY</b> , <b>WARM AIR</b> and <b>COOL AIR</b> cycles. The following time options (unit: minute) are available: 30, 60, 90, 120, 150 and 180. <ul style="list-style-type: none"> <li>• 120, 150 and 180 minutes are not available for <b>WARM AIR</b> and <b>COOL AIR</b> cycle.</li> <li>• The exact drying time differs depending on the humidity of the load.</li> </ul>

# Operations

<p>05  <b>Auto Cycle Link</b></p>	<p>Depending on the cycle selected on the washer, the most suitable dryer cycle will be set when you touch this button.</p> <p>This function is only available when you turn on <b>Auto cycle Link</b> in SmartThings app in your smartphone.</p> <ul style="list-style-type: none"> <li>• <b>Auto Cycle Link is only available when both the washer and dryer have Wi-Fi connected.</b></li> </ul>
<p>06  <b>Smart Control</b></p>	<p>Tap to activate or deactivate the Smart Control function.</p> <ul style="list-style-type: none"> <li>• When the Smart Control function is activated, you can control your dryer remotely using the SmartThings app in your smartphone.</li> </ul>
<p>07  <b>Sound On/Off</b></p>	<p>Press to turn on or turn off the sound from the dryer. The sound setting is retained when you turn the dryer off and turn it on again.</p>
<p>08  <b>Drum Light</b></p>	<p>Press to turn on or off the interior lamp. The lamp stays lit for 2 minutes after it has turned on, and then turns off automatically.</p>
<p>09  <b>Damp Alert</b></p>	<p>This alarm is available only with <b>COTTON, MIXED LOAD, and SYNTHETICS</b> cycle. If a load contains mixed fabrics, the Damp Alert indicator () blinks when the average dryness of the item is 80 % dry. This lets you take items that you don't want fully dried or that dry quickly out of the dryer early while letting others continue to dry.</p>
<p>10  <b>Wrinkle Prevent</b></p>	<p>Adds approximately 3 hours of intermittent tumbling at the end of the selected cycle to reduce wrinkles. A large circle appears in display panel, and the drum rotates intermittently. To activate, press  <b>Wrinkle Prevent</b>. The corresponding indicator blinks.</p>
<p>11  <b>Power</b></p>	<p>Press to turn the dryer on/off. If the dryer turns on for 10 minutes without any button being pressed, the dryer automatically turns off.</p>
<p>12  <b>Start/Pause</b></p>	<p>Press to start or pause a cycle. If the dryer is running, press the button once to pause the dryer. Press again to resume.</p>



## Icon description

	<p><b>Check Filter</b></p>	<ul style="list-style-type: none"> <li>• The filter needs cleaning. (After Power on and for few seconds you can always see this alarm on the display.)</li> </ul>
	<p><b>Clean Heat Exchanger</b></p>	<ul style="list-style-type: none"> <li>• The heat exchanger needs cleaning.</li> </ul>
	<p><b>Drying</b></p>	<ul style="list-style-type: none"> <li>• The drying process is in progress.</li> </ul>
	<p><b>Cooling</b></p>	<ul style="list-style-type: none"> <li>• The cooling process is in progress.</li> </ul>
	<p><b>Wi-Fi</b></p>	<ul style="list-style-type: none"> <li>• This icon indicates that the dryer is connected to Wi-Fi.</li> </ul>

	<b>Water Tank Full</b>	<ul style="list-style-type: none"> <li>The water tank is full.</li> </ul>
	<b>Child Lock</b>	<ul style="list-style-type: none"> <li>The Child Lock function is on.</li> </ul>

## Cycle overview

### Optimal Dry

Cycle	Description	Max load (kg)
<b>MIXED LOAD</b>	For mixed loads consisting of cotton and synthetic fabrics.	MAX
<b>DELICATES</b>	For items to be handled with care such as lingerie.	2
<b>IRON DRY</b>	This cycle finishes the drying process in a moist state, which facilitates ironing.	MAX
<b>WOOL</b> 	For machine washable and tumble dryable wool only. For best results, turn laundry inside out before drying.	1
<b>TOWELS</b>	Use to dry loads such as bath towels.	4
<b>BEDDING</b>	For bulky items such as blankets, sheets, comforters, and light duvets.	2
<b>OUTDOOR</b>	For outdoor wear such as skiwear and mountain clothing, and also for fabrics such as spandex, stretch, and microfiber. It is recommended to use this cycle after you have washed your laundry using the <b>OUTDOOR</b> cycle with your washing machine.	2
 <b>COTTON</b>	For lightly cottons, bed linen, table linen, underwear, towels, and shirts.	MAX
<b>SYNTHETICS</b>	For lightly soiled blouses, and shirts that are made of polyester (Diolen, Trevira), polyamide (Perlon, nylon), or other similar blends.	4
<b>HYGIENE CARE</b>	For sanitizing wet and dry clothes and linen fabric to eliminate bacteria. DV**CGC2**** models only.	2
<b>DOWNLOADED</b>	Select to choose from more cycles available on the SmartThings app on your smartphone. <ul style="list-style-type: none"> <li>Factory setting: SHIRTS</li> </ul>	2

# Operations

## Manual Dry

Cycle	Description	Max load (kg)
QUICK DRY 35'	For drying light cotton synthetics or items that needs quick drying. The default Time is 35 minutes.	1
TIME DRY	Use to set a desired Time. <ol style="list-style-type: none"><li>1. Turn the <b>Cycle Selector</b> to select <b>TIME DRY</b>.</li><li>2. Press <b>Time</b> to set the drying time between 30 minutes and 180 minutes. Keep pressing <b>Time</b> cycles through the available time options in 30-minute increments.</li></ol> <p><b>NOTE</b> The actual cycle time may differ depending on the dryness of items.</p>	-
WARM AIR	For small, pre-dried items. The Time defaults to 30 minutes. Timed cycle for all types of fabric except for wool and silk. Dry laundry that is still slightly damp or has already been pre-dried. Also suitable for the subsequent drying of multi-layered, thick laundry that does not dry readily. <p><b>NOTE</b> This cycle is suitable for drying individual woollen fabrics, sports shoes and soft toys. Only dry these using the basket for woollens. DV**CGC0**** models only.</p>	-
COOL AIR	All types of fabric. For freshening up or airing items of laundry that have not been worn for long.	-





## Cycle chart

### NOTE

For best results, follow the load size recommendations for each dry cycle.

- Large load: Fill the drum to about  $\frac{3}{4}$  full. Do not add items over this level as they need to tumble freely.
- Medium load : Fill the drum to about  $\frac{1}{2}$  full.
- Small load : Fill the drum with 3-5 items, not more than  $\frac{1}{4}$  full.

Cycle	Recommended items	Load size	Dry Level
MIXED LOAD	Mixed load consisting of cotton and synthetic fabrics	MAX	Available
DELICATES	Silk, fine fabrics and lingerie.	2 ●	Unavailable
IRON DRY	This cycle finishes the drying process in a moist state, which facilitates ironing.	MAX	Unavailable
WOOL 	For machine washable and tumble dryable wool only.	1 ●	Unavailable
TOWELS	Use to dry loads such as bath towels.	4 ●	Unavailable
BEDDING	For bulky items such as blankets, sheets, comforters, and light duvets.	2 ●	Unavailable
OUTDOOR	For outdoor wear such as skiwear and mountain clothing, and also for fabrics such as spandex, stretch, and microfiber.	2 ●	Unavailable
 COTTON	For lightly cottons, bed linen, table linen, underwear, towels, and shirts.	MAX	Available
SYNTHETICS	Synthetic or blended fabrics.	4 ●	Available
HYGIENE CARE (DV**CGC2****)	Use to sterilize cotton items such as towels, diapers, and handkerchiefs.	2 ●	Unavailable
QUICK DRY 35'	Synthetics and light cottons	1 ●	Unavailable
TIME DRY	All types of fabric; time programme.	-	Unavailable
WARM AIR (DV**CGC0****)	Small Items & damp clothing Everyday items suitable for heat drying	-	Unavailable
COOL AIR	All types of fabric. For freshening up or airing items of laundry that have not been worn for long.	-	Unavailable







# Operations

English

Cycle	Recommended items		Load size	Dry Level
↓ DOWNLOADED	SHIRTS	Non-iron shirts or blouses made of cotton, linen, synthetic fibres or blended fabrics.	2 	Unavailable
	DENIM	For drying items made out of denim, such as jeans.	3 	Unavailable
	AIR REFRESH	Use this cycle to disinfect clothes and make them feel fresher and cleaner.	1 	Unavailable
	AIR BEDDING	For dusting off clothes, bed spreads, bed sheets and bedding covers, etc.	2 	Unavailable
	WARM AIR (DV**CGC2****)	Small Items & damp clothing Everyday items suitable for heat drying	-	Unavailable

## Getting started



### Simple steps to start

1. Press  **Power** to turn the dryer on.
2. Make sure the lint filter is installed.
3. Load the dryer and close the door.
4. Turn the **Cycle Selector** to select a cycle.
5. Change the cycle settings ( **Dry Level**, and  **Time**) as necessary.
6. Select necessary settings and options to your preference. ( **Wrinkle Prevent**,  **Drum Light**, and/or  **Damp Alert**).
7. Press  **Start/Pause**. The dryer indicator lights up, and the estimated cycle time appears on the display.

### NOTE

- When you turn on the power, the Check Filter  indicator blinks for few seconds and then turns off. It is normal.
- The number of available settings and options differs with the cycle.

### To change the cycle during operation

1. Press  **Start/Pause** to stop operation.
2. Select a different cycle.
3. Press  **Start/Pause** to start new cycle.

### Sorting and loading

- Put only one wash load in the dryer at a time.
- Avoid mixing heavy and lightweight items together.
- To increase drying efficiency when drying one or two items, add a dry towel to the load.
- For best results, untangle items before inserting into the dryer.
- Overloading restricts the tumbling process, resulting in uneven drying and wrinkling.
- Unless recommended on the care label, avoid drying woollens or fibreglass items.
- Avoid drying unwashed items.
- Do not dry items soiled with oil, alcohol, gasoline, etc.



# Operations

## Cycle guide

Always follow the care label when drying. If care label instructions are not available, refer to the following table.

<b>Bedspreads and comforters</b>	<ul style="list-style-type: none"> <li>Use the High temperature settings.</li> </ul>
<b>Blankets</b>	<ul style="list-style-type: none"> <li>For best results, dry only one blanket at a time.</li> </ul>
<b>Cloth diapers</b>	<ul style="list-style-type: none"> <li>Use the High temperature settings.</li> </ul>
<b>Down-filled items</b>	<ul style="list-style-type: none"> <li>Do not dry on a heat setting. Doing so may cause a fire hazard. Only use the <b>COOL AIR</b> cycle.</li> </ul>
<b>Foam rubber (rug backs, stuffed toys, etc.)</b>	<ul style="list-style-type: none"> <li>Do not dry on a heat setting. Doing so may cause a fire hazard. Only use the <b>COOL AIR</b> cycle.</li> </ul>
<b>Pillows</b>	<ul style="list-style-type: none"> <li>Add a few dry towels to help tumble and fluff items.</li> <li>Do not dry kapok or foam pillows with heat. Use only the <b>COOL AIR</b> cycle.</li> </ul>
<b>Plastics (shower curtains, outdoor furniture covers, etc.)</b>	<ul style="list-style-type: none"> <li>Use <b>COOL AIR</b> or <b>TIME DRY</b>.</li> <li>Set the dry level to lower or the lowest.</li> </ul>

### CAUTION

Do not use the dryer to dry items that are not listed above.



## Special features

### Child Lock

Child Lock prevents children from playing with the dryer. When Child Lock is activated, all buttons except for the  Power button are disabled.

To activate/deactivate Child Lock, simultaneously press and hold  Dry Level and  Time for 3 seconds.



#### NOTE

If Child Lock is activated, and the dryer is turned off and then on again, Child Lock remains activated.



### Smart Control

You can connect to the SmartThings app and control your dryer remotely.

#### Connecting your dryer



- Download and open the SmartThings app on your mobile device
- Tap and hold  to turn on the dryer.
- Tap and hold  on the dryer.
  - a. The dryer enters AP mode and connects to your mobile device.
  - b. Tap  to authenticate your dryer on your mobile device.
  - c. Once the authentication process is complete, your dryer is successfully connected to the app. Use various features available in the SmartThings app.

#### NOTE

- If your dryer fails to connect with the SmartThings app, try again.
- Check your router if you experience any Internet connection problem after connecting your dryer with the SmartThings app.
- Wi-Fi On, Off can be set by pressing  Time +  Smart Control for 3 seconds.
- Turning the dryer's Wi-Fi on allows you connect to the dryer via SmartThings app on your smartphone regardless of the power status of the dryer. However, the dryer appears offline on the SmartThings app if the dryer's Wi-Fi is off.
- Close the door before starting the Smart Control function.
- If you use the dryer 20 times without being connected to SmartThings, the next time you turn the dryer on, a pop-up about Smart Control connection will appear for 3 seconds.
- If the dryer's Wi-Fi is not connected to an AP (access point), the Wi-Fi will turn off when you turn of the power.

#### Stay Connect

Set up the Stay Connect function in your SmartThings app. Your dryer stays connected to the app so you can use the dryer when you are away from home.

1. If you turn on the Stay Connect function on the SmartThings app, the dryer will stay in standby power saving mode after completing a cycle.
  - The Stay Connect function will remain active for up to 24 hours if the door remains closed.
2. When the Stay Connect function is active, the Smart Control  and Wi-Fi  turn on your dryer display.
3. Conveniently control your dryer using the SmartThings app.

#### NOTE

The dryer switches to standby power saving mode when operation is paused even if the machine is not connected to the SmartThings app.



# Operations

---

## SmartThings

### Wi-Fi connection

On your smartphone, go to **Settings** and turn on the wireless connection and select an AP (Access Point).

- This appliance supports the Wi-Fi 2.4 GHz protocols.

### Download

On an app market (Google Play Store, Apple App Store, Samsung Galaxy Apps), find the SmartThings app with a search term of “SmartThings”. Download and install the app on your device.

#### NOTE

The app is subject to change without notice for improved performance.

In addition, the further updates on app or the function in the app may stop due to usability and security reasons, even if updates are currently supported on your OS.

### Log in

You must first log into SmartThings with your Samsung account. To create a new Samsung account, follow the instructions on the app. You don't need a separate app to create your account.

#### NOTE

If you have a Samsung account, use the account to log in. A registered Samsung smartphone user automatically logs in.

### To register your appliance to SmartThings

1. Make sure your smartphone is connected to a wireless network. If not, go to **Settings** and turn on the wireless connection and select an AP (Access Point).
2. Open **SmartThings** on your smartphone.
3. If a message of “A new device is found.”, select **Add**.
4. If no message appears, select **+** and select your appliance in a list of devices available. If your appliance is not listed, select **Device Type > Specific Device Model**, and then add your appliance manually.
5. Register your appliance to the SmartThings app as follows.
  - a. Add your appliance to SmartThings. Make sure your appliance is connected to SmartThings.
  - b. When registration is complete, your appliance appears on your smartphone.



## Open Source Announcement

The software included in this product contains open source software. You may obtain the complete corresponding source code for a period of three years after the last shipment of this product by contacting our support team via <http://opensource.samsung.com> (Please use the "Inquiry" menu.)

It is also possible to obtain the complete corresponding source code in a physical medium such as a CD-ROM; a minimal charge will be required.

The following URL [http://opensource.samsung.com/opensource/SMART\\_AT\\_051/seq/0](http://opensource.samsung.com/opensource/SMART_AT_051/seq/0) leads to the open source license information as related to this product. This offer is valid to anyone in receipt of this information.



### NOTE

Hereby, Samsung declares that this radio equipment is in compliance with Directive 2014/53/EU and with the relevant statutory requirements in the UK. The full text of the EU declaration of conformity and the UK declaration of conformity is available at the following internet address: The official Declaration of conformity may be found at <http://www.samsung.com>, go to Support > Support home and enter the model name.

Wi-Fi max transmitter power : 20 dBm at 2.412 GHz – 2.472 GHz

# Operations

## Using the drying rack (applicable models only)

Set the drying time up to 180 minutes according to the moisture and weight of the items to dry. When drying laundry using the drying rack, the Time Dry cycle is recommended.

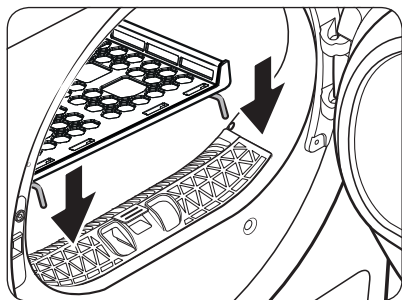

1. Position the drying rack in the drum, inserting the front lips of the rack into the holes of the door diaphragm.

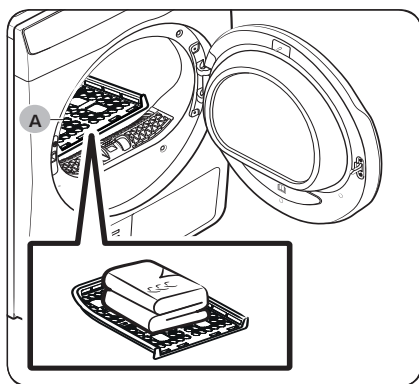

2. Place items on the rack, leaving enough space where air can circulate. For clothing items, fold and place flat on the rack.
3. Close the door and press **Power**. Turn the Cycle Selector to select **TIME DRY**, and then press **Time** to select the drying time.
4. Press **Start/Pause**.

A. Drying rack

## Drying suggestions

Items (max 1.5 kg)	Description
Washable sweaters (block to shape and lay flat on rack)	When drying the laundry using the rack, fold and place the clothes on the rack to prevent the clothing from becoming wrinkled.
Stuffed toys (cotton or polyester fiber filled)	

### ⚠ CAUTION

- Drying foam rubber, plastic, or rubber on a heat setting may cause damage to the items and lead to a fire hazard.



# Maintenance

## Emptying the water tank (☒)

Empty the water tank after each use to prevent leaks.

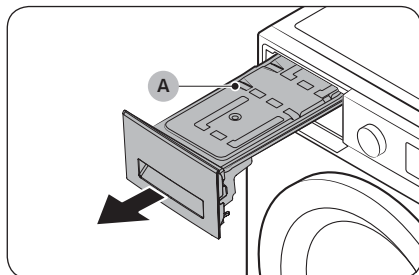

1. Remove the **water tank (A)** from the dryer.
  - Pull the water tank handle with one hand until the tank is halfway out.
  - Once the water tank is halfway out, support the bottom of the tank with the other hand and pull it slowly with both hands.

### ⚠ CAUTION

- The water tank is heavy. Slowly remove the water tank using both hands while keeping the tank at a level.
  - Be careful when removing the full water tank. It is very heavy and can cause injury if you drop it.
2. Empty the water through the **drain hole (B)**, and then clean inside the water tank.
    - Mix some neutral detergent in lukewarm water. Fill the water tank with the mixture through the **drain hole (B)** and leave it for 30 minutes. Then, rinse the tank with clean water and completely dry it.
  3. Place the water tank back into place.

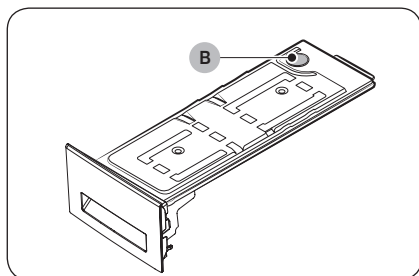

### 📖 NOTE

If the dryer displays the “5C” information code and stops while drying is in progress, empty the water tank and press ▶|| **Start/Pause**. The “5C” information code will disappear, and the dryer will resume drying.

# Maintenance

---

## Cleaning

---

### WARNING

- Do not clean the dryer by directly spraying water onto the dryer.
- Do not clean the dryer with benzene, thinner, alcohol, or acetone. This may cause discoloration, deformation, damage, electric shock, or fire.
- Before cleaning the dryer, be sure to unplug the power cord.

### Exterior

Clean with a soft, damp cloth. Do not use abrasive cleaners. Avoid using or placing sharp or heavy objects near/on the dryer. Keep detergent and laundry supplies on the pedestal (sold separately) or in a separate storage container.

### Control panel

Clean with a soft, damp cloth. Do not use abrasive cleaners. Do not spray cleaners directly on the panel. Immediately wipe up any spills or liquids from the control panel.

### Drum

Clean with a damp cloth with a mild, non-abrasive cleaner suitable for stainless steel. Wipe remaining residue with a clean, dry cloth.

### Door

Foreign substances can contaminate or build up on the inside of the door. Clean the inside of the door using a soft piece of cloth or brush.

### CAUTION

Do not detach the door's rubber sealing.

## Lint filter

Clean the lint filter after each use.

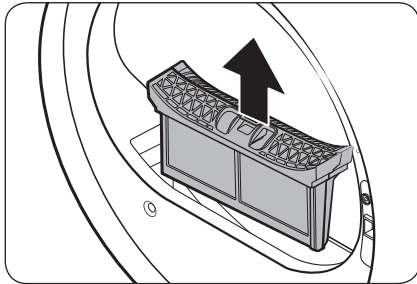

1. Open the dryer door, grab the top of the lint filter, and pull to remove the filter.
  - Do not detach the rubber sealing after removing the filter.

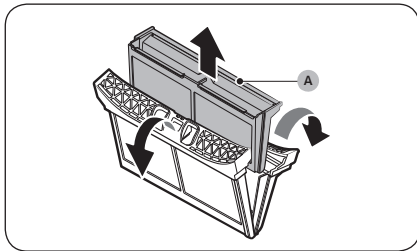

2. Open the outer filter and remove the **inner filter (A)**.

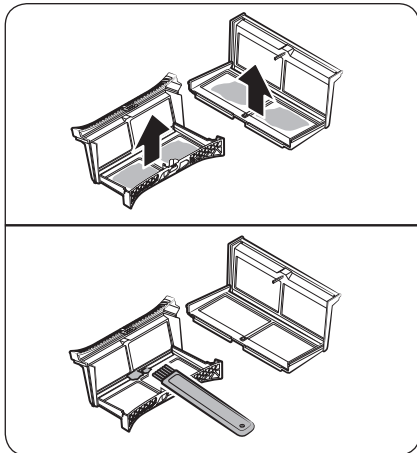

3. Spread open the outer filter and the inner filter.
4. Remove the lint from both filters, and then clean the filters with the cleaning brush.



# Maintenance

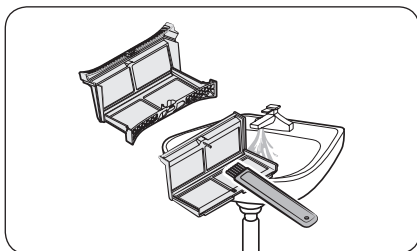

## NOTE

To clean the filters thoroughly, clean the filters in running water, and then dry them completely.

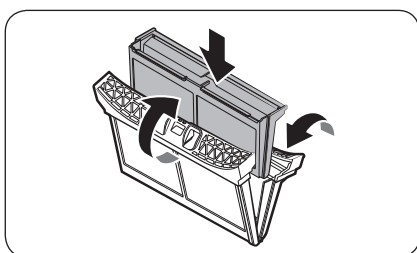

- Put the inner filter into the outer filter, and then reinsert the lint filter into the original position.

## CAUTION

- Clean the lint filter after each load. Otherwise, the drying performance may decrease.
- If the filter surface is wet, allow it to completely dry before use.
  - Inserting the filter while it is wet can cause mold and/or odor to form and/or result in less drying.
- When cleaning or removing the lint filter, do not shake or tap on the filter. Doing so can damage the filter.
- Opening the outer and inner filters carelessly and with excessive force can damage the filters.

## Heat exchanger

When it is time to clean the heat exchanger, the Clean Heat Exchanger  indicator lights up and the alert sounds.

A dirty heat exchanger may reduce the drying performance and should be cleaned regularly. Clean the heat exchanger at least once a month.

A dirty heat exchanger will hinder the product's performance and should be cleaned regularly.

## NOTE

- Water droplets can form around the heat exchanger due to condensation caused by a temperature difference. This is normal and is not a sign of a leak.
- If you are not planning on using the dryer for a long period of time, open the heat exchanger cover and ventilate.



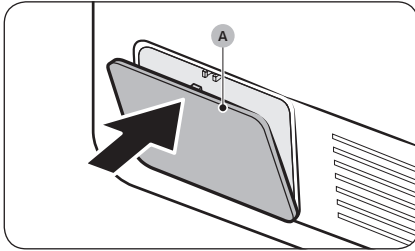

1. Gently press the top part of the **outer cover (A)** to open.

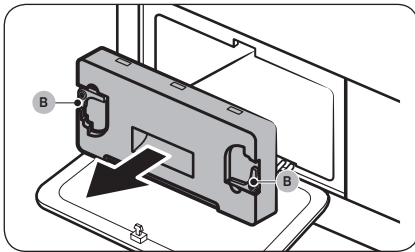

2. Unlock the inner cover **fixers (B)**, and then pull the inner cover to remove.
  - A small amount of leaked refrigerant may remain around the heat exchanger. Before cleaning, open the heat exchanger cover and ventilate for about 10 minutes.

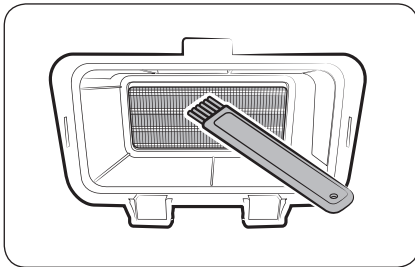

3. Clean the dust on the heat exchanger using the provided brush.
  - After cleaning with the brush, wipe off the remaining dust using a smooth, damp cloth.

**⚠ CAUTION**

- To avoid physical injury and burns, do not touch or clean the heat exchanger with bare hands and steel tools.
- When cleaning the heat exchanger, be careful not to damage the fins.

**📖 NOTE**

If the heat exchanger is completely dry and therefore hard to clean, spray some water on the heat exchanger and clean using a brush.

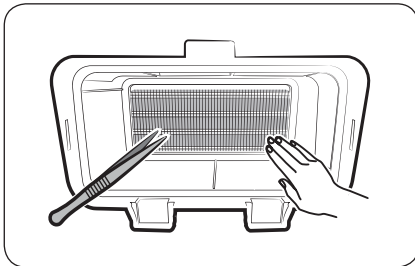



# Maintenance

---

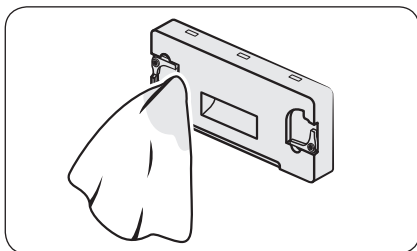

4. Clean the inner cover with a smooth, damp cloth.
  - There may be moisture and/or foreign substances around the inner cover.

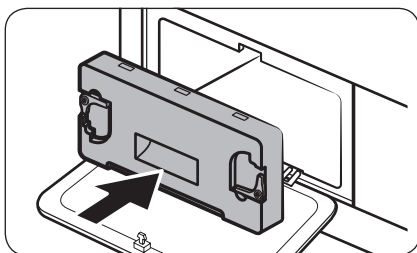

5. Reinsert the inner cover to its original position, and then lock the fixers.
6. Close the heat exchanger's outer cover.

## NOTE

- After cleaning the heat exchanger, make sure the fixers are locked.
- If the alarm continues after you have dismissed it, unplug and then plug in the power cord or remove and reinsert the heat exchanger's inner cover.



# Troubleshooting

## Checkpoints

If you encounter an issue with the dryer, first check the table below and try the suggestions.

Symptom	Action
Door is open	<p>Operating the dryer with the door open.</p> <ul style="list-style-type: none"><li>• Make sure the door is properly closed.</li><li>• Make sure laundry is not caught in the door.</li></ul>
Dryer does not run	<ul style="list-style-type: none"><li>• Make sure the door is completely closed.</li><li>• Make sure the power cord is plugged in.</li><li>• Check the home's circuit breaker and fuses.</li><li>• Empty the water tank.</li><li>• Clean the lint filter.</li></ul>
Dryer does not heat	<ul style="list-style-type: none"><li>• Check the home's circuit breaker and fuses.</li><li>• Select a heat setting other than <b>COOL AIR</b>.</li><li>• Check the lint filter and heat exchanger. Clean them if necessary.</li><li>• Dryer may be in the cool-down phase of the cycle.</li></ul>
Dryer does not dry	<p>Check the above, plus...</p> <ul style="list-style-type: none"><li>• Make sure the dryer is not overloaded.</li><li>• Sort light and heavy items separately.</li><li>• Reposition large, bulky items to ensure even drying.</li><li>• Check that the dryer is draining properly.</li><li>• For small loads, add a few dry towels.</li><li>• Clean the lint filter and heat exchanger.</li></ul>
Dryer is noisy	<ul style="list-style-type: none"><li>• Check for coins, buttons, lighters, etc.</li><li>• Make sure the dryer is level and standing firmly on the floor.</li><li>• The dryer may hum due to air moving through the drum and fan. This is normal.</li></ul>
Dries unevenly	<ul style="list-style-type: none"><li>• Seams, pockets, and other parts of clothing are harder to dry than others. This is normal.</li><li>• Sort heavy and light items separately.</li></ul>
Dryer emits an odour	<ul style="list-style-type: none"><li>• The dryer may draw household odours in from the surrounding air and then exhaust them. This is normal.</li></ul>
Dryer turns off before the load is dry	<ul style="list-style-type: none"><li>• Dryer load is too small. Add more items and restart the cycle.</li><li>• Dryer load is too large. Remove items and restart the cycle.</li></ul>



# Maintenance

Symptom	Action
Lint on clothes	<ul style="list-style-type: none"> <li>• Make sure the lint filter is clean before every load.</li> <li>• Dry lint-producing items (fuzzy towels) separate from lint trappers, such as black linen pants.</li> <li>• Divide larger loads into smaller loads.</li> </ul>
Items still wrinkled after  Wrinkle Prevent	<ul style="list-style-type: none"> <li>• Small loads of 1-4 items work best.</li> <li>• Load fewer items. Load similar type items.</li> </ul>
Odours remain in items after COOL AIR	<ul style="list-style-type: none"> <li>• Make sure to thoroughly wash items with strong odours.</li> </ul>

## Information codes

If the dryer fails to operate, you may see an information code on the display. Check the table below and try the suggestions.

Information code	Meaning	Action
tC	Air temperature sensor issue	Clean the lint filter and/or heat exchanger. If this continues, call for service.
tC5	Compressor temperature sensor issue	Wait 2-3 minutes. Turn the power on and restart.
AC6	Check communications between the main and the inverter PBAs.	<ul style="list-style-type: none"> <li>• Depending on the state, the dryer may automatically returns to normal operation.</li> <li>• Turn the dryer off and turn it on again. Then, restart the cycle.</li> <li>• If the information code continues to appear, call for service.</li> </ul>
3C	Check the motor for operation.	<ul style="list-style-type: none"> <li>• Try restarting the cycle.</li> <li>• If the information code continues to appear, call for service.</li> </ul>
FIL+tEr (Alert sounds)	Heat exchanger needs to be cleaned	Clean the heat exchanger.
dC	Dryer operation with the door open	<ul style="list-style-type: none"> <li>• Close the door and start again.</li> <li>• If this continues, call for service.</li> <li>• Check if Child Lock is on. If Child Lock is on, you may get this message when you open the door even though the dryer is not operating.</li> </ul>





Information code	Meaning	Action
CL	Child Lock is on. Open the door and check inside the drum.	<ul style="list-style-type: none"> <li>• If Child Lock is on, turn off Child Lock or the power.</li> </ul>
nC	Lint filter problem	<ul style="list-style-type: none"> <li>• Check the lint filter assembly.</li> <li>• If this continues, call for service.</li> </ul>
nC2	Internal heat exchanger cover problem	<ul style="list-style-type: none"> <li>• Check the internal heat exchanger cover assembly.</li> <li>• If this continues, call for service.</li> </ul>
5C	Draining malfunction Draining pump malfunction Frozen draining hose Water tank full	<ul style="list-style-type: none"> <li>• Make sure the draining hose is not bent or damaged.</li> <li>• If the hose is frozen, wrap the hose with a towel soaked in warm water for approximately ten minutes to thaw the hose.</li> <li>• Empty the water tank, turn on the dryer, and start again.</li> <li>• If this continues, call for service.</li> </ul>
HC	Compressor overheating	<ul style="list-style-type: none"> <li>• If this continues, call for service.</li> </ul> Please check the cleaning condition of heat exchanger and lint filter.

For any codes not listed above, or if the information code continues to appear, call for service.



# Appendix

## Fabric care chart

The following symbols provide garment care direction. The Clothing care labels include symbols for drying, bleaching, drying and ironing, or dry cleaning when necessary. The use of symbols ensures consistency among garment manufacturers of domestic and imported items. Follow care label directions to maximize garment life and reduce laundering problems.

### Washing

	95 °C boil wash.
	60 °C coloured wash.
	60 °C coloured wash. ("Easy care" coloured wash)
	40 °C coloured wash.
	40 °C mild wash.
	40 °C very mild wash.
	30 °C fine wash.
	30 °C mild fine wash.
	30 °C very mild fine wash.
	Hand wash.
	Do not wash.

### NOTE

The numbers in the wash tub specify the maximum washing temperatures in degrees celsius which must not be exceeded.

### Bleaching

	Any bleach allowed.
	Only oxygen bleach allowed.
	Do not bleach.

### Drying





	Tumble drying / Drying at a temperature of 80 °C with a normal drying process.
	Tumble drying / Drying at a temperature of 60 °C with a mild drying process.
	Do not tumble dry
	Line drying.
	Drip line drying.
	Flat drying.
	Drip flat drying.
	Line drying in the shade.
	Drip line drying in the shade.
	Flat drying in the shade.
	Drip flat drying in the shade.

### NOTE

- The dots indicate the drying level of the dryer.
- The lines indicate the type and place of the drying.





## Ironing







	Iron at maximum sole plate temperature of 200 °C.
	Iron at maximum sole plate temperature of 150 °C.
	Iron at maximum sole plate temperature of 110 °C. Caution when using steam irons (work without steam).
	Do not iron.

### NOTE

The dots indicate the temperature ranges for ironing (regulator, steam, travel irons and ironing machines).

## Professional care

	Professional dry-cleaning in perchloroethylene and/or hydrocarbons (heavy benzines) with normal process.
	Professional dry-cleaning in perchloroethylene and/or hydrocarbons (heavy benzines) with gentle process.

	Professional dry-cleaning in hydrocarbons (heavy benzines) with normal process.
	Professional dry-cleaning in hydrocarbons (heavy benzines) with gentle process.
	Do not dry-clean.
	Professional wet-cleaning.
	Mild professional wet-cleaning.
	Very mild professional wet-cleaning.
	Do not wet-clean.

### NOTE

- The letters in a circle indicate the solvents (P, F) used in dry cleaning or wet cleaning (W).
- Generally, the line under the symbol indicates a milder treatment (e.g. gentle cycle for easy-care items). The double line indicates care levels with particularly gentle treatment.

## Protecting the environment

- This appliance is manufactured from recyclable materials. If you decide to dispose of this appliance, please observe local waste disposal regulations. Cut off the power cord so that the appliance cannot be connected to a power source. Remove the door so that animals and small children cannot get trapped inside the appliance.

Contains fluorinated greenhouse gases.

Hermetically sealed equipment.

Do not vent gases into the atmosphere.

Refrigerant (Type): R-134a (GWP = 1430)

Refrigerant (Charging)

- DV\*\*CGC2\*\*\*\* : 0.43kg, 0.615tCO<sub>2</sub>e
- DV\*\*CGC0\*\*\*\* : 0.37kg, 0.529tCO<sub>2</sub>e

# Appendix

English

## Specification

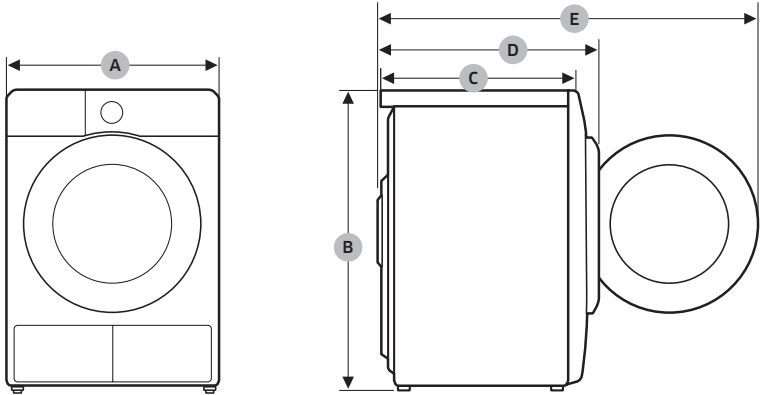

TYPE		FRONT LOADING DRYER	
MODEL NAME		DV**CGC2****	DV**CGC0****
DIMENSIONS	A	600 mm	600 mm
	B	850 mm	850 mm
	C	600 mm	600 mm
	D	650 mm	650 mm
	E	1100 mm	1100 mm
WEIGHT		49.0 kg	48.0 kg
ELECTRICAL REQUIREMENTS	220-240 V / 50 Hz	550-600 W	600-650 W
ALLOWABLE TEMPERATURE		5-35 °C	5-35 °C

## Consumption data

Model	Program	Load (kg) <sup>(1)</sup>	Energy (kWh)	Max. Duration (Minutes)
DV9*CGC2****	COTTON <sup>(2)</sup>	9.0	1.54	220
		4.5	0.89	140
	IRON DRY <sup>(2)</sup>	9.0	0.95	140
	SYNTHETICS	4.0	0.60	90
DV8*CGC2****	COTTON <sup>(2)</sup>	8.0	1.41	200
		4.0	0.80	130
	IRON DRY <sup>(2)</sup>	8.0	0.90	130
	SYNTHETICS	4.0	0.60	90

<sup>(1)</sup> : Weight of dry laundry

<sup>(2)</sup> : EN 61121:2013 test program

All data without a "star" against it was calculated using EN 61121:2013

Consumption data can vary from the nominal values given above depending in the size of the load, types of textiles, residual moisture levels after spinning, fluctuations in the electricity supply and any extra options selected.

Model	Program	Load (kg) <sup>(1)</sup>	Energy (kWh)	Max. Duration (Minutes)
DV9*CGC0****	COTTON <sup>(2)</sup>	9.0	2.15	210
		4.5	1.12	145
	IRON DRY <sup>(2)</sup>	9.0	1.05	130
	SYNTHETICS	4.0	0.70	85
DV8*CGC0****	COTTON <sup>(2)</sup>	8.0	1.85	190
		4.0	1.10	135
	IRON DRY <sup>(2)</sup>	8.0	0.95	120
	SYNTHETICS	4.0	0.70	85

<sup>(1)</sup> : Weight of dry laundry

<sup>(2)</sup> : EN 61121:2013 test program

All data without a "star" against it was calculated using EN 61121:2013

Consumption data can vary from the nominal values given above depending in the size of the load, types of textiles, residual moisture levels after spinning, fluctuations in the electricity supply and any extra options selected.





# Appendix

## Specification sheet



In accordance with applicable energy labelling regulations.

### NOTE

“ \* ” Asterisk(s) means variant model and can be varied (0-9) or (A-Z).

Samsung			
Model Name		DV8*CGC0****	DV9*CGC0****
Capacity	kg	8.0	9.0
Type		Condenser	Condenser
Energy Efficiency			
A+++ (highest efficiency) to D (least efficient)		A++	A++
Energy Consumption			
Annual Energy Consumption (AE_C) (Energy consumption is based on 160 drying cycles of the standard cotton programme at full and partial load, and the consumption of the lowpower modes. Actual energy consumption per cycle will depend on how the appliance is used.)	kWh/yr	235.0	258.0
Automatic tumble drier	kWh	Yes	Yes
Energy consumption (E_dry) standard cotton programme at full load	kWh	1.85	2.15
Energy consumption (E_dry,1/2) standard cotton programme at partial load	kWh	1.10	1.12
off mode and left-on mode			
The power consumption off-mode (P_o) at full load	W	0.50	0.50
The power consumption in left-on mode (P_l) at full load	W	5.00	5.00
Duration of the left-on mode	min	10	10
Programme to which the information on the label and the Sheet relate ('standard cotton programme' used at full and partial load is the standard drying programme to which the information in the label and the fiche relates. This programme is suitable for drying normal wet cotton laundry and it is the most efficient programme in terms of energy consumption for cotton. Consumption data can vary from the nominal values given above depending on the size of the load, types of textiles, residual moisture levels after spinning, fluctuations in the electricity supply and any extra options selected.)		 Cotton +  Dry Level 2 + (Wrinkle Prevent off)	
programme duration of the standard program			
Weighted Programme time standard cotton programme at full load and partial load	min	159	173
Programme Time (T_dry) standard cotton programme at full load	min	190	210
Programme Time (T_dry,1/2) standard cotton programme at partial load	min	135	145
condensation efficiency class			
A (most efficient) to G (least efficient)		B	B
Average condensation efficiency at full load	%	86	86
Average condensation efficiency at partial load	%	86	86
Weighted condensation efficiency	%	86	86
Airborne noise emissions			
Dry at full load	dB (A) re1 pW	65	65



Samsung				
Model Name		DV8*CGC2****	DV9*CGC2****	
Capacity	kg	8.0	9.0	
Type		Condenser	Condenser	
Energy Efficiency				
A+++ (highest efficiency) to D (least efficient)		A+++	A+++	
Energy Consumption				
Annual Energy Consumption (AE_C) (Energy consumption is based on 160 drying cycles of the standard cotton programme at full and partial load, and the consumption of the lowpower modes. Actual energy consumption per cycle will depend on how the appliance is used.)		kWh/yr	176.0	194.0
Automatic tumble drier		kWh	Yes	Yes
Energy consumption (E_dry) standard cotton programme at full load		kWh	1.41	1.54
Energy consumption (E_dry,1/2) standard cotton programme at partial load		kWh	0.80	0.89
off mode and left-on mode				
The power consumption off-mode (P_o) at full load		W	0.50	0.50
The power consumption in left-on mode (P_l) at full load		W	5.00	5.00
Duration of the left-on mode		min	10	10
Programme to which the information on the label and the Sheet relate ('standard cotton programme' used at full and partial load is the standard drying programme to which the information in the label and the fiche relates. This programme is suitable for drying normal wet cotton laundry and it is the most efficient programme in terms of energy consumption for cotton. Consumption data can vary from the nominal values given above depending on the size of the load, types of textiles, residual moisture levels after spinning, fluctuations in the electricity supply and any extra options selected.)		 Cotton +  Dry Level 2 + (Wrinkle Prevent off)		
programme duration of the standard program				
Weighted Programme time standard cotton programme at full load and partial load		min	160	174
Programme Time (T_dry) standard cotton programme at full load		min	200	220
Programme Time (T_dry,1/2) standard cotton programme at partial load		min	130	140
condensation efficiency class				
A (most efficient) to G (least efficient)			B	B
Average condensation efficiency at full load		%	87	87
Average condensation efficiency at partial load		%	87	87
Weighted condensation efficiency		%	87	87
Airborne noise emissions				
Dry at full load		dB (A) re 1 pW	65	65

# Contact information

## QUESTIONS OR COMMENTS?

COUNTRY	CALL	OR VISIT US ONLINE AT
UK	0333 000 0333	<a href="http://www.samsung.com/uk/support">www.samsung.com/uk/support</a>
IRELAND (EIRE)	0818 717100	<a href="http://www.samsung.com/ie/support">www.samsung.com/ie/support</a>
GERMANY	06196 77 555 77	<a href="http://www.samsung.com/de/support">www.samsung.com/de/support</a>
FRANCE	01 48 63 00 00	<a href="http://www.samsung.com/fr/support">www.samsung.com/fr/support</a>
SPAIN	91 175 00 15	<a href="http://www.samsung.com/es/support">www.samsung.com/es/support</a>
PORTUGAL	210 608 098 Chamada para a rede fixa nacional Dias úteis das 9h às 20h	<a href="http://www.samsung.com/pt/support">www.samsung.com/pt/support</a>
LUXEMBURG	261 03 710	<a href="http://www.samsung.com/be_fr/support">www.samsung.com/be_fr/support</a>
NETHERLANDS	088 90 90100	<a href="http://www.samsung.com/nl/support">www.samsung.com/nl/support</a>
BELGIUM	02-201-24-18	<a href="http://www.samsung.com/be/support">www.samsung.com/be/support</a> (Dutch) <a href="http://www.samsung.com/be_fr/support">www.samsung.com/be_fr/support</a> (French)
NORWAY	21629099	<a href="http://www.samsung.com/no/support">www.samsung.com/no/support</a>
DENMARK	707 019 70	<a href="http://www.samsung.com/dk/support">www.samsung.com/dk/support</a>
FINLAND	030-6227 515	<a href="http://www.samsung.com/fi/support">www.samsung.com/fi/support</a>
SWEDEN	0771-400 300	<a href="http://www.samsung.com/se/support">www.samsung.com/se/support</a>
AUSTRIA	0800 72 67 864 (0800-SAMSUNG)	<a href="http://www.samsung.com/at/support">www.samsung.com/at/support</a>
SWITZERLAND	0800 726 786	<a href="http://www.samsung.com/ch/support">www.samsung.com/ch/support</a> (German) <a href="http://www.samsung.com/ch_fr/support">www.samsung.com/ch_fr/support</a> (French)
HUNGARY	0680SAMSUNG (0680-726-7864)	<a href="http://www.samsung.com/hu/support">www.samsung.com/hu/support</a>
CZECH	800 - SAMSUNG (800-726786)	<a href="http://www.samsung.com/cz/support">www.samsung.com/cz/support</a>
SLOVAKIA	0800 - SAMSUNG (0800-726 786)	<a href="http://www.samsung.com/sk/support">www.samsung.com/sk/support</a>
CROATIA	072 726 786	<a href="http://www.samsung.com/hr/support">www.samsung.com/hr/support</a>
BOSNIA	055 233 999	<a href="http://www.samsung.com/ba/support">www.samsung.com/ba/support</a>
North Macedonia	023 207 777	<a href="http://www.samsung.com/mk/support">www.samsung.com/mk/support</a>
MONTENEGRO	020 405 888	<a href="http://www.samsung.com/support">www.samsung.com/support</a>
SLOVENIA	080 697 267 (brezplačna številka)	<a href="http://www.samsung.com/si/support">www.samsung.com/si/support</a>
SERBIA	011 321 6899	<a href="http://www.samsung.com/rs/support">www.samsung.com/rs/support</a>



COUNTRY	CALL	OR VISIT US ONLINE AT
Kosovo	038 40 30 90	<a href="http://www.samsung.com/support">www.samsung.com/support</a>
ALBANIA	045 620 202	<a href="http://www.samsung.com/al/support">www.samsung.com/al/support</a>
BULGARIA	0800 111 31 - Безплатен за всички оператори *3000 - Цена на един градски разговор или според тарифата на мобилният оператор 09:00 до 18:00 - Понеделник до Петък	<a href="http://www.samsung.com/bg/support">www.samsung.com/bg/support</a>
ROMANIA	0800872678 - Apel gratuit *8000 - Apel tarifat în rețea	<a href="http://www.samsung.com/ro/support">www.samsung.com/ro/support</a>
ITALIA	800-SAMSUNG (800.7267864)	<a href="http://www.samsung.com/it/support">www.samsung.com/it/support</a>
CYPRUS	8009 4000 only from landline, toll free	<a href="http://www.samsung.com/gr/support">www.samsung.com/gr/support</a>
GREECE	80111-SAMSUNG (80111 726 7864) only from land line (+30) 210 6897691 from mobile and land line	
POLAND	801-172-678* lub +48 22 607-93-33* * (opłata według taryfy operatora)	<a href="http://www.samsung.com/pl/support/">http://www.samsung.com/pl/support/</a>
LITHUANIA	8-800-77777	<a href="http://www.samsung.com/lt/support">www.samsung.com/lt/support</a>
LATVIA	8000-7267	<a href="http://www.samsung.com/lv/support">www.samsung.com/lv/support</a>
ESTONIA	800-7267	<a href="http://www.samsung.com/ee/support">www.samsung.com/ee/support</a>

**SAMSUNG**