

# Chequer Corner TV Unit

Assembly Instructions - Please keep for future reference

399/9015

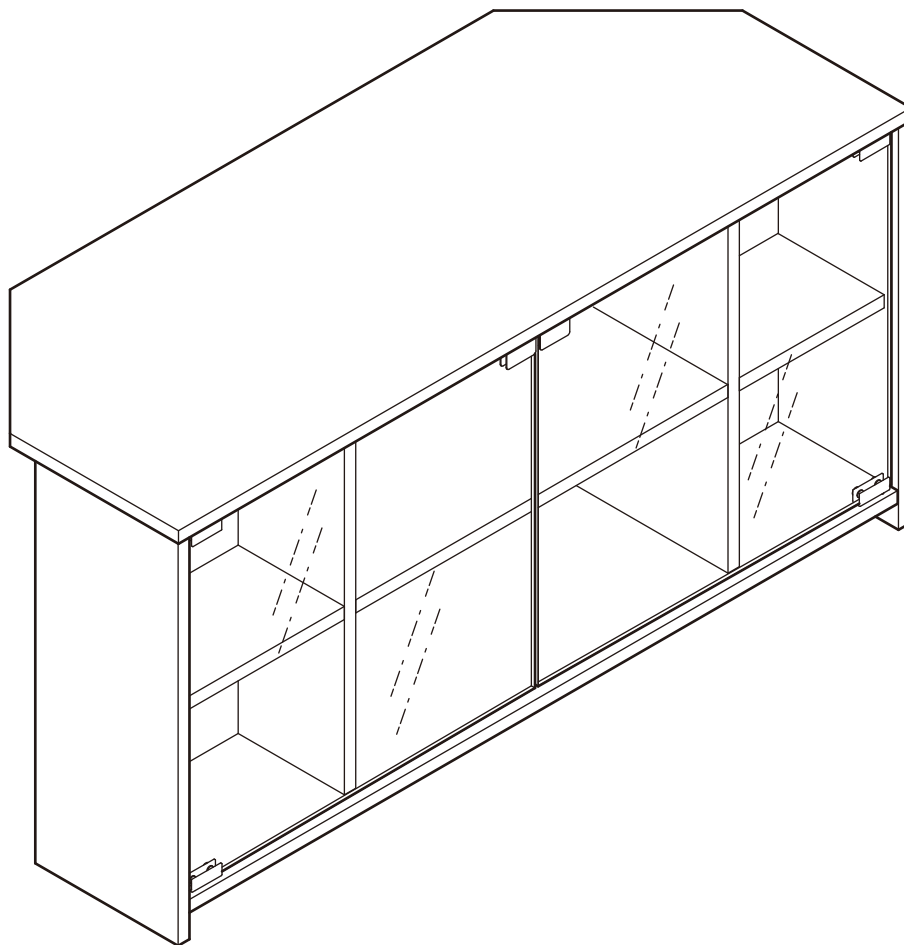

## Dimensions

Width - 100cm

Depth - 40.5cm

Height - 49.5cm

**Important** - Please read these instructions fully before starting assembly

If you need help or have damaged or missing parts, call the **Customer Helpline:**  
**Argos = 0345 6400800**



# Safety and Care Advice

## Important – Please read these instructions fully before starting assembly

- Check you have all the components and tools listed on the following pages.
- Remove all fittings from the plastic bags and separate them into their groups.
- Keep children and animals away from the work area, small parts could choke if swallowed.
- Make sure you have enough space to layout the parts before starting.

- During assembly do not stand or put weight on the product, this could cause damage.
- Assemble the item as close to its final position (in the same room) as possible.
- Assemble on a soft level surface to avoid damaging the unit or your floor.
- Parts of the assembly will be easier with 2 people.



- To reduce the likelihood of damaging your product please ensure that your power drill is set on a low torque setting.

## Care and maintenance

- Only clean using a damp cloth and mild detergent, do not use bleach or abrasive cleaners.
- From time to time check that there are no loose screws on this unit.
- This product should not be discarded with household waste. Take to your local authority waste disposal centre.

## Handy Hints

- Regularly check and ensure that all bolts and fittings are tightend properly.

## Glass safety

- Keep these instruction for future reference.
- Imported by:  
Argos Ltd.  
489-499 Avebury Boulevard.  
Saxon Gate West.  
Central Milton Keynes.  
MK9 2NW
- If the glass is chipped or broken, stop using product and consult the Manufacturer or Supplier.
- Batch No. & Date of manufacturer: Please refer to the label stick on product back panel.
- Type of glass used: 5mm toughened glass

## Warnings

- (a) Do not place very hot or very cold items on the glass surface(s) unless adequately thick table mats are used to prevent such items from coming into contact with the glass.
- (b) Do not sit or stand upon the glass surface(s).
- (c) Do not use the glass as a chopping surface. Do not strike the glass with hard or pointed items.
- (d) When cleaning glass panels use a damp cloth or leather with washing up liquid or soft soap if necessary, do not use washing powders or any other substance containing abrasives since these substances scratch glass.

# Components - Panels

If you have damaged or missing components, call the Customer Helpline: Argos = 0345 6400800

Please check you have all the panels listed below

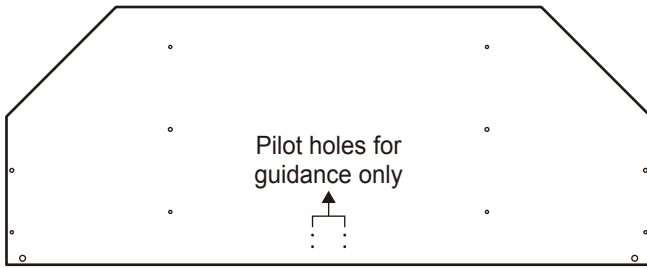

**1** Top panel (100 x 40cm)

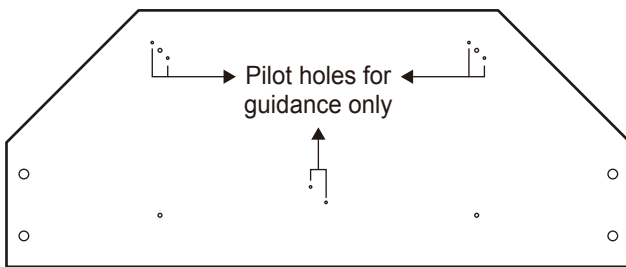

**2** Bottom panel (96.8 x 39.8cm)

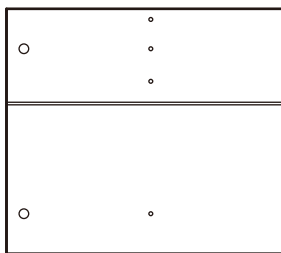

**3** Middle Left panel (43 x 38cm)

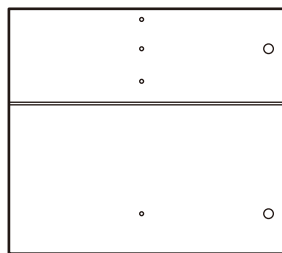

**4** Middle right panel (43 x 38cm)

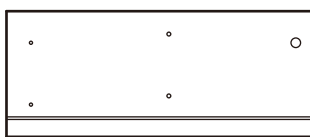

**5** Left panel (47.6 x 19.5cm)

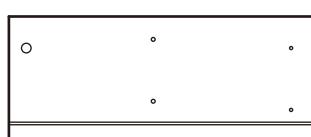

**6** Right panel (47.6 x 19.5cm)



**7** Middle shelf panel (47.6 x 37.9cm)



**8** Shelf panel x 2 (23 x 14.5cm)

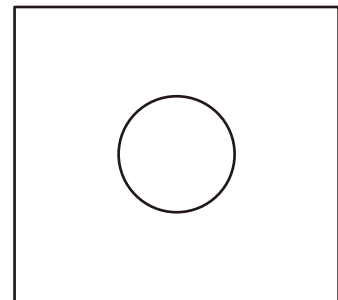

**9** Large back panel (50.3 x 45.7cm)



**10** Small back panel x 2 (23.7 x 43cm)

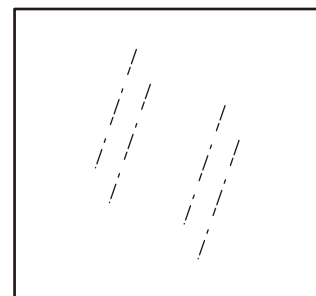













**11** Door x 2 (47.9 x 42.1cm)

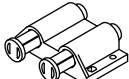

# Components - Fittings

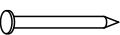
Please check you have all the fittings listed below

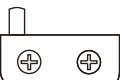
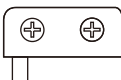
**Note:** The quantities below are the correct amount to complete the assembly. In some cases more fittings may be supplied than are required.

<b>A</b>  30mm Dowel x 12	<b>B</b>  50mm Screw x 8	<b>C</b>  39mm Locking pin x 10
<b>D</b>  14mm Screw x 6	<b>E</b>  (This screw is included in the door magnet bag) 15mm Screw x 4	<b>F</b>  15mm Locking nut x 10
<b>G</b>  Foot x 3	<b>H</b>  Door magnet x 1	<b>I</b>  Hinge plug x 4
<b>J</b>  Nail x 14	<b>K</b>  Foam pad x 2	<b>L</b>  Small foam pad x 4
<b>M</b>  Top hinge x 2	<b>N</b>  Bottom hinge x 2	<b>O</b>  Door push x 2

## Tools required

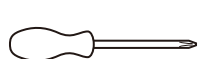

Phillips screwdriver  
(medium & large)

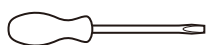

Flatblade screwdriver  
(medium)



7mm Suitable drill bit  
(for use with wall plug)

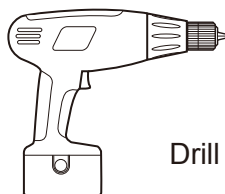

Drill



Small  
hammer



Ruler/tape  
measure



Eye protection  
(when using a  
hammer or glue)

## Ruler - Use this ruler to help correctly identify the screws

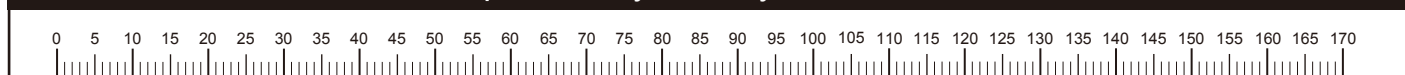

The screws length is measured from the head to the point (30mm screw shown).

# Assembly Instructions

## Step 1

### Attaching the middle shelf panel

**a:** Insert Dowels **A** into the Middle right panel **4** and Middle left panel **3**.

Use Screws **B** to fix the Middle right panel **4** and Middle left panel **3** onto the Middle shelf panel **7**.

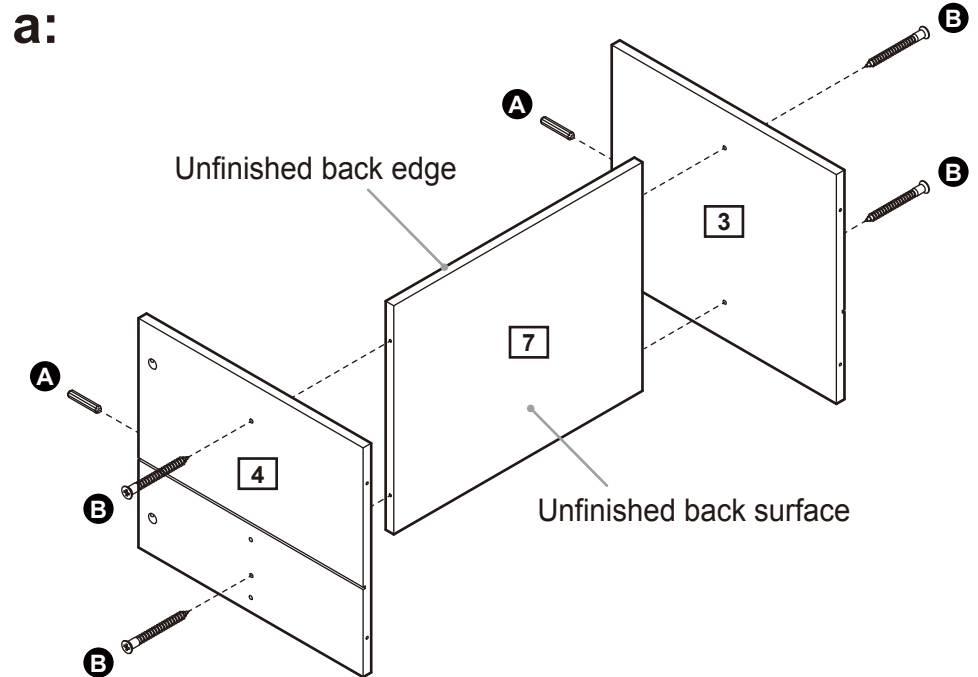

**b:** Insert Dowels **A** into Shelf panel **8**.

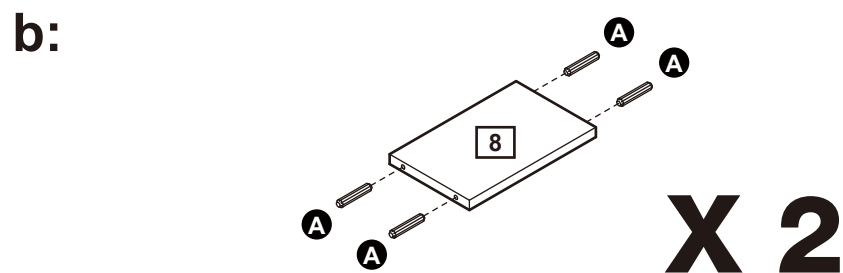

**c:** Position Shelf panels **8** onto the Middle right panel **4** and Middle left panel **3**.

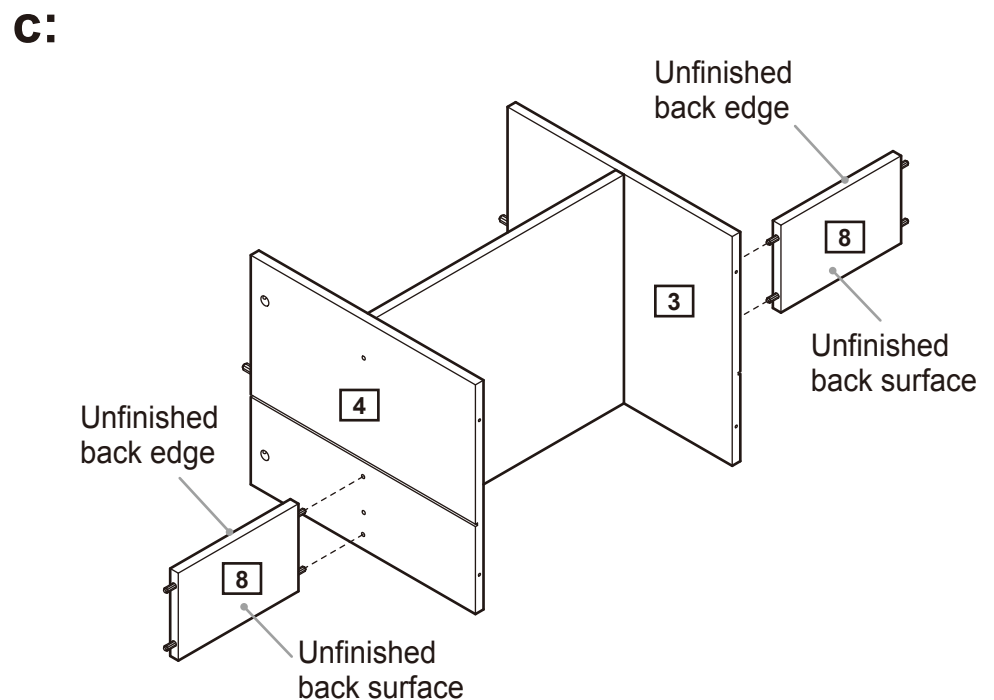

# Assembly Instructions

## Step 2

### Attaching bottom panel

Use Screws **B** to fix Bottom panel **2** onto the Middle right panel **4** and Middle left panel **3**.

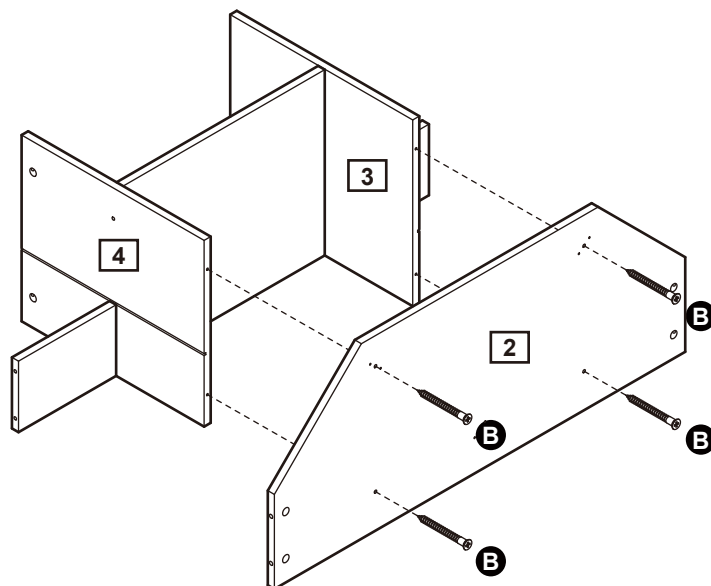

## Step 3

### Attaching right panel and left panel

**a:** Insert Dowels **A** and Screw Locking pins **C** into the Right panel **6** and Left panel **5**.

**Note:** Insert Locking pins as far as shown. **Do not over tighten.**

**a:**

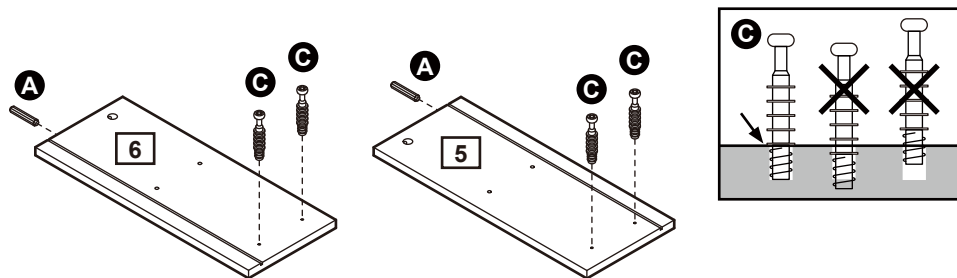

**b:** Position the Right panel **6** and Left panel **5** onto the unit.

Insert 4 Locking nuts **F** into the unit.

Use a screwdriver to turn Locking nuts **F** clockwise to lock.

Use Screws **D** to fix Foot **G** onto the unit.

**b:**

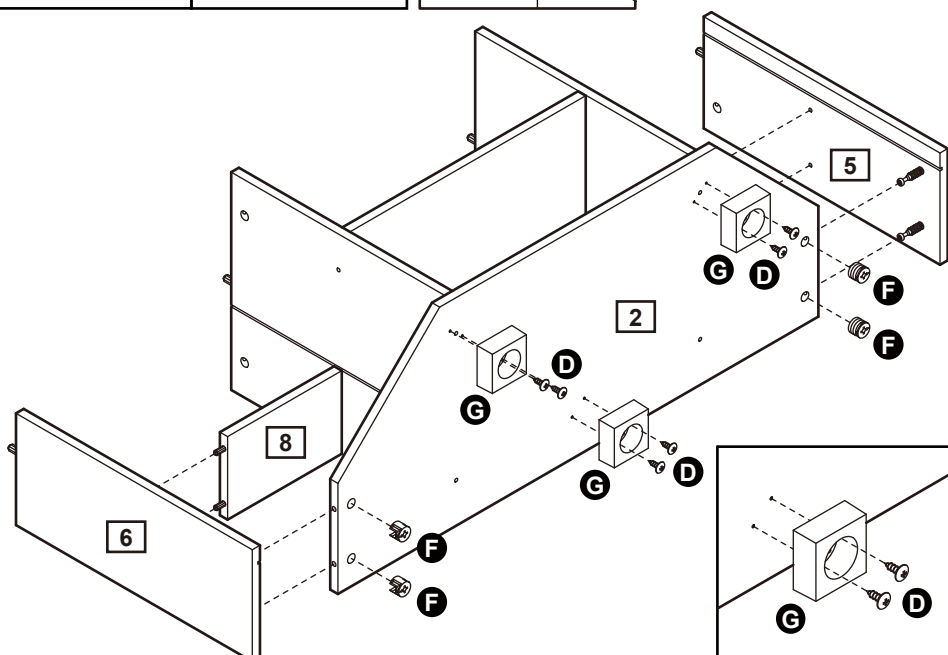
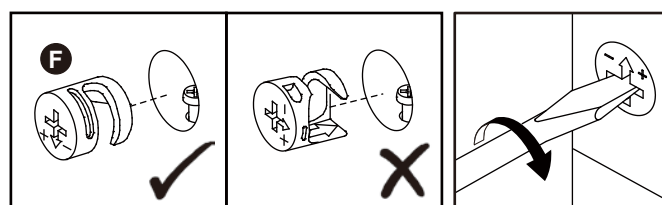

# Assembly Instructions

## Step 4

### Attaching small back panels

Slide small back panels **10** into the unit.

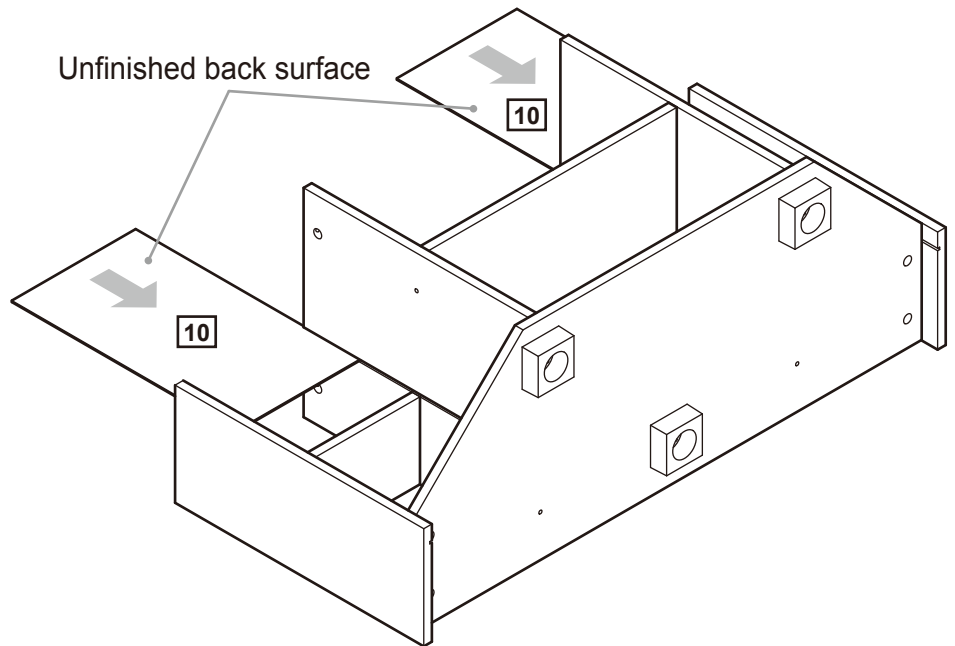

## Step 5

### Attaching top panel

**a:** Use Screws **E** to fix the Door magnet **H** onto the Top panel **1**.

Insert Hinge plugs **I** into the Top panel **1**.

Screw Locking pins (6 pcs) **C** into the Top panel **1**.

**Note:** Insert Locking pins as far as shown.

**Do not over tighten.**

**a:**

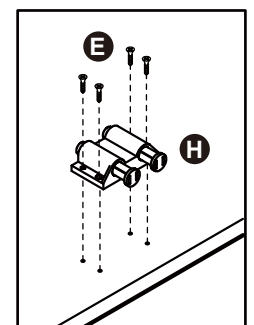
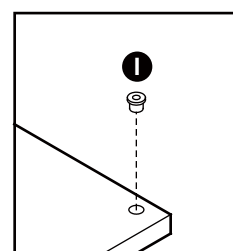
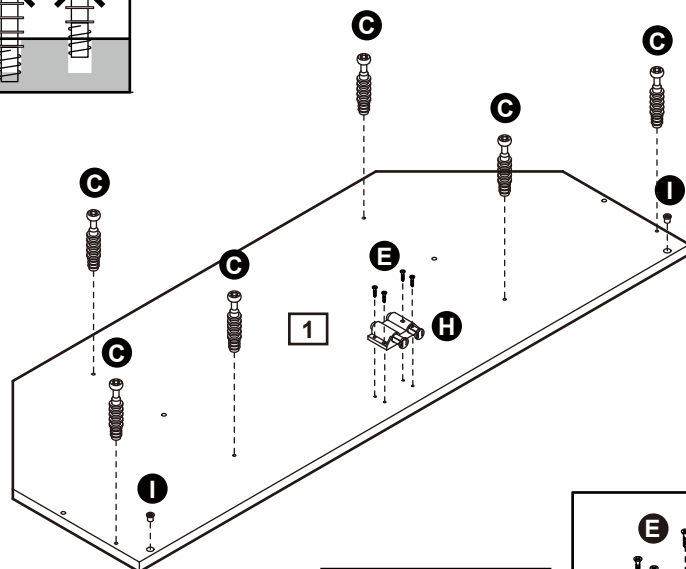
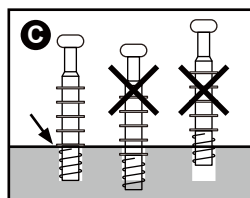

Continued on next page.

# Assembly Instructions

## Step 5 - continued

**b:** Carefully locate the Top panel **1** onto the unit.

Insert 6 Locking nuts **F** into the unit.

Use a screwdriver to turn Locking nuts **F** clockwise to lock.

Insert Hinge plugs **I** into the Bottom panel **2**.

**b:**

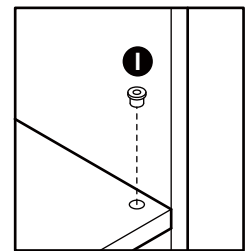
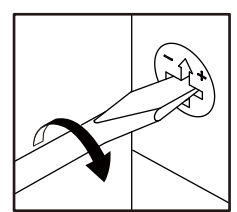
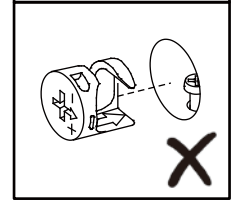
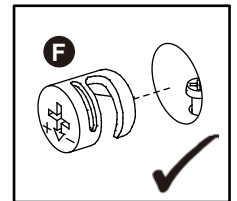
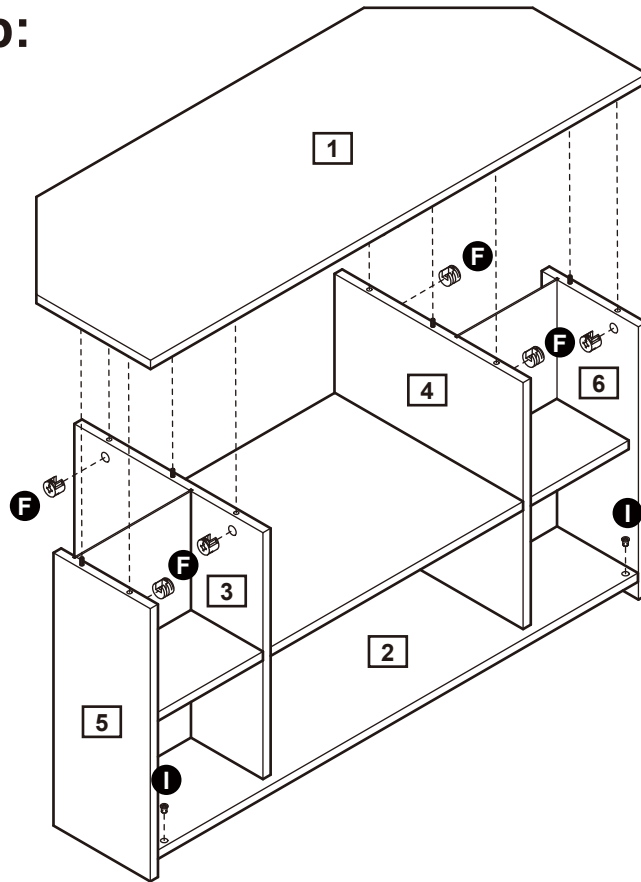

## Step 6

### Fixing large back panel

Attach large back panel **9** using nails **J**.



**Important:**  
The unit **MUST** be 'square' when back is attached.

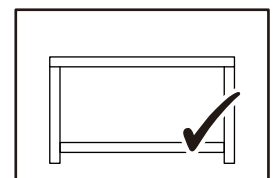
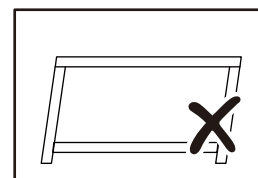
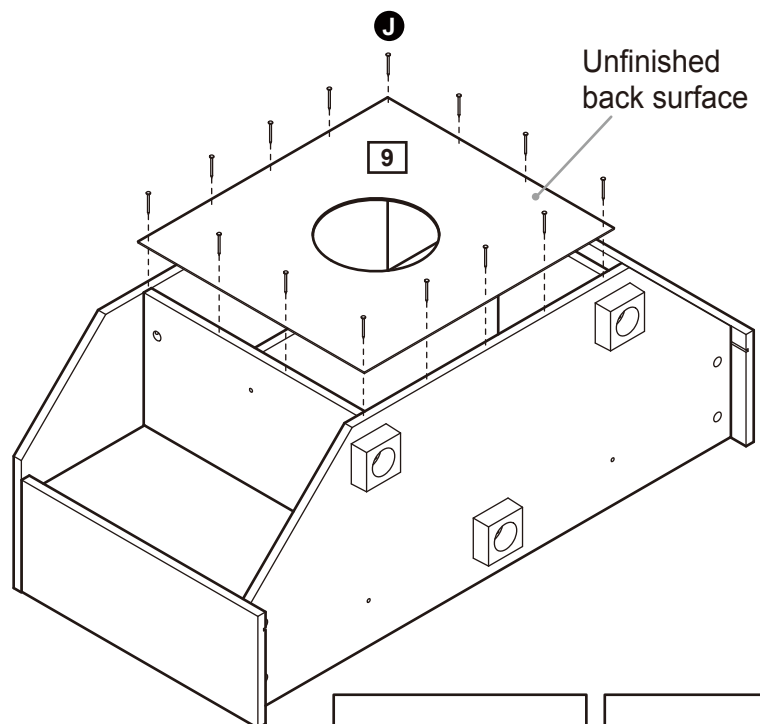



# Assembly Instructions

## Step 7

### Fitting the glass doors

**a:** Tear off the protective backing from the Foam pad **K** and Small foam pad **L**.

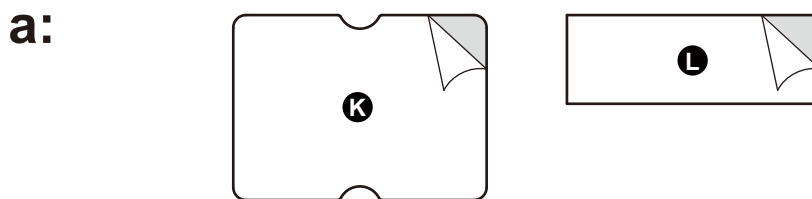

**b:** Carefully stick the Foam pad **K** onto the Glass door **11** so that it wraps over Glass door. Locate the Door push **O** over the top of the Foam pad and Glass door.

Carefully stick the Small foam pads **L** onto the Glass door **11**. Then slide the Bottom hinge **N** onto the Glass door **11**, and tighten the screws to fix position.

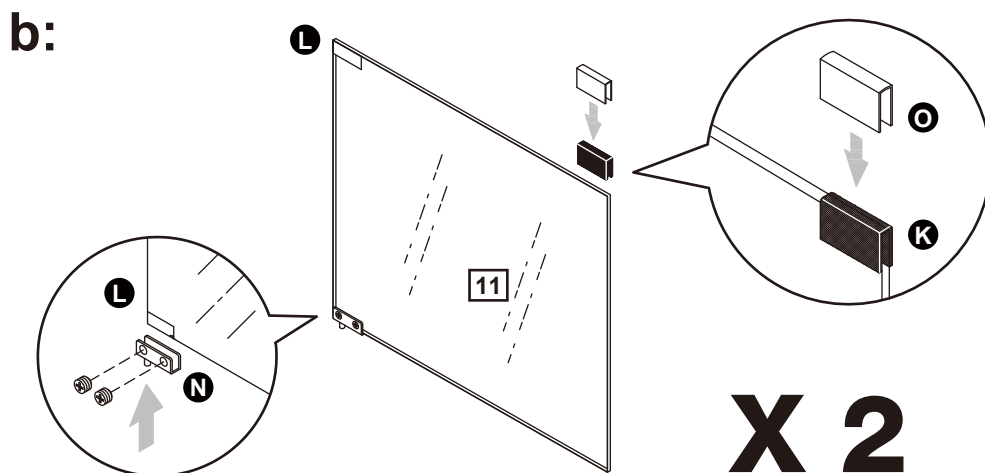

**c:** Insert the Top hinges **M** into the Hinge plug **I**.

Carefully locate the Bottom hinges **N** into the Hinge plugs **I**.

Carefully slide the Glass doors **11** into the Top hinges **M**, ensuring they are parallel with they unit. Then tighten the screws to fix in position.

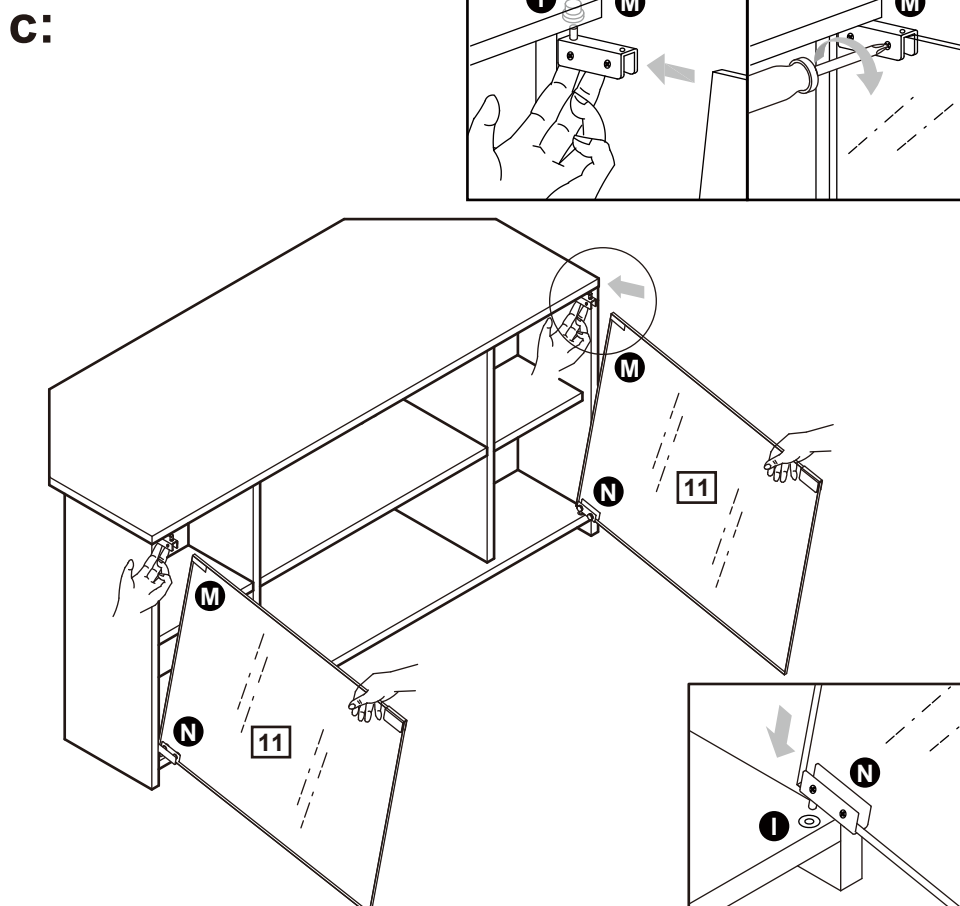

# Assembly Instructions

## Step 8

### Finishing the unit

**Note:** It would be useful to ask someone to help you at this stage.

With help, place the unit in the intended position.

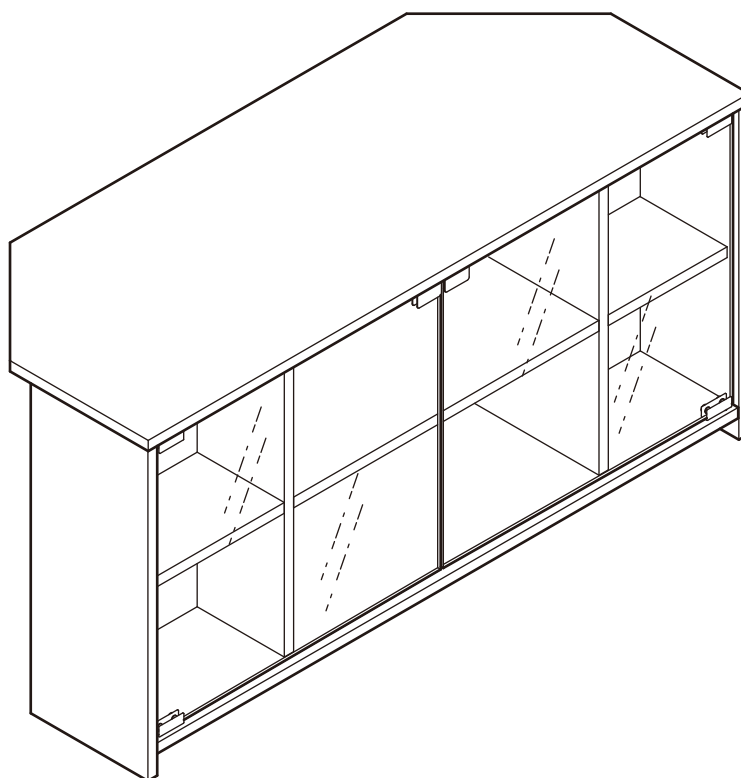

**Assembly is complete.**

If you need help or have damaged or missing parts, call the **Customer Helpline:**  
**Argos = 0345 6400800**