



## Spare Parts

 [www.argos-support.co.uk](http://www.argos-support.co.uk)

 [Help@ClickSpares.co.uk](mailto:Help@ClickSpares.co.uk)

 0370 112 1928

## Customer Support

 0345 640 2020



# Safety and Care Advice

---

## Product Details

3262797, 3442342 (table)

## IMPORTANT, RETAIN FOR FUTURE REFERENCE: READ CAREFULLY.

- Keep children and animals away from the work area, small parts could choke if swallowed.
- Assemble the item as close to its final position (in the same room) as possible.
- Assemble on a soft level surface to avoid damaging the unit or your floor.
- We do not recommend the use of power drill/drivers for inserting screws as this could damage the unit. Only use hand screwdrivers.
- Parts of the assembly will be easier with 2 people.
- Dispose of all packaging carefully and responsibly.

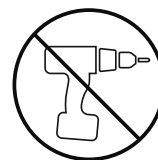

## Care and maintenance

---

- Only clean using a damp cloth and mild detergent. Do not use abrasive cleaners.
- From time to time check that there are no loose screws, nuts or bolts. If there are please re-tighten.
- This product should not be discarded with household waste. Take to your local authority waste disposal centre.
- Use a dry cloth to clean the product, furniture polish is not recommended.

## Additional Guidance

---

- Assemble all parts and bolts loosely during assembly, only once the product is complete should you fully tighten the bolts.
- Regularly check and ensure that all bolts and fittings are tightend properly.
- Maximum user weight 25kg
- This product is compliant BS 4875-7, EN 12521

# Fittings (Shown to scale)

## Bag 1

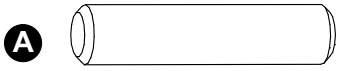

**A**  $\varnothing 8 \times 35$  Wooden Dowel x 48



**B**  $\varnothing 3 \times 20$  mm Screw x 12



**C** Cam Lock Cap x 4



**D** Cam Lock x 28

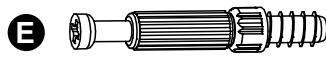

**E** Metal Cam Screw x 28



**F**  $\varnothing 5 \times 13$  mm Screw x 8



**G** bumper x 4

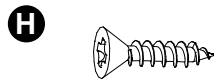

**H**  $\varnothing 3 \times 16$  mm Screw x 15

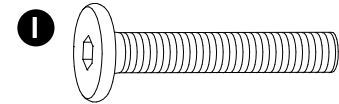

**I** M6x35 mm Screw x 4



**J**  $\varnothing 20 \times 2$  mm Felt pad x 4

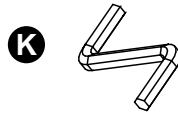

**K** Allen Key x 1



**L** Plastic Wedge x 2

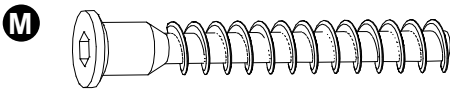

**M**  $\varnothing 7 \times 50$  mm hexagon bolt x 12

# Hardware

---

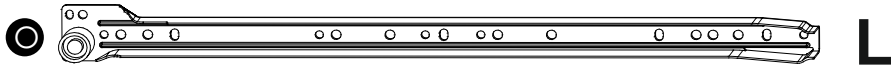

Drawer guide (panel side) x 2

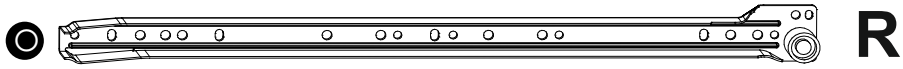

Drawer guide (panel side) x 2



Drawer guide (drawer side) x 2

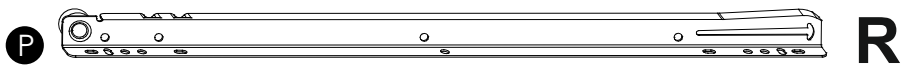

Drawer guide (drawer side) x2



L 200- mm Wooden Leg x 4

# Tools required

---

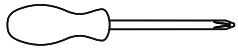

Phillips screwdriver  
(small & medium)

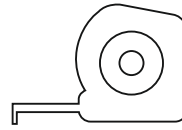

Ruler/tape  
measure



Phillips screwdriver  
(small & medium)

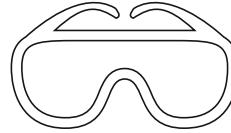

Eye protection  
(when using a  
hammer or glue)



Small  
hammer

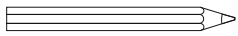

Pencil

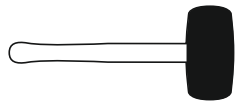

Mallet



Spirit Level

# Panels

---

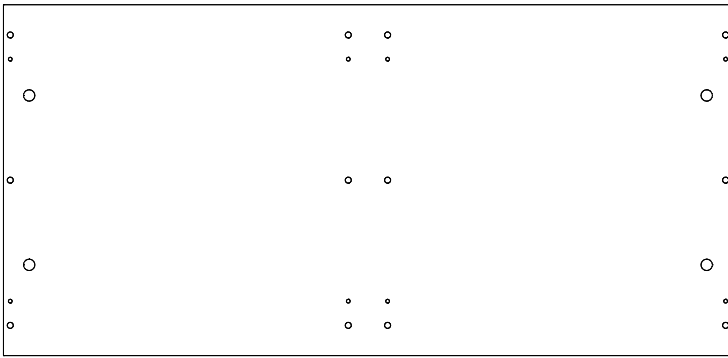

**1** Top panel x 1 (96x46cm)

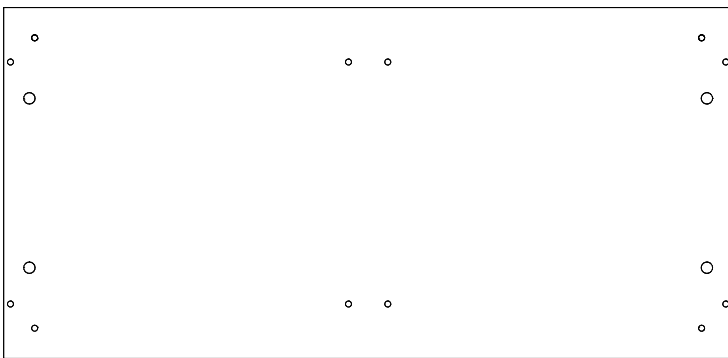

**2** Bottom panel x 1 (96x46cm)



**6** Decorative panel x 2 (50x21cm)

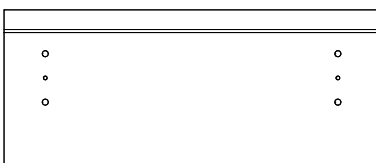

**7** Drawer front x 2 (50x21cm)



**8** Drawer right side x 2 (45x12cm)



**9** Drawer left side x 2 (45x12cm)



**10** Drawer back x 2 (37x12cm)

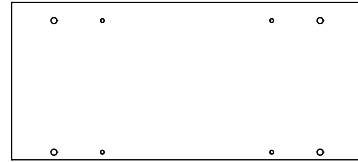

**3** Side panel x 2 (21x46cm)

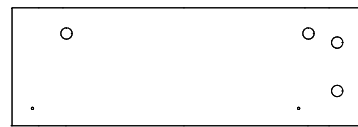

**4** Outside partition panel x 2 (16x46cm)

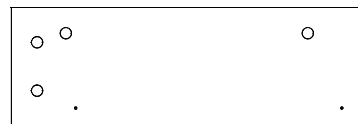

**5** Inside partition panel x 2 (16x46cm)

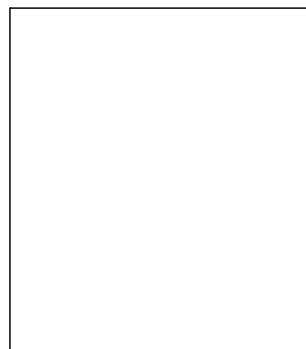

**11** Drawer bottom x 2 (40x46cm)

# 1

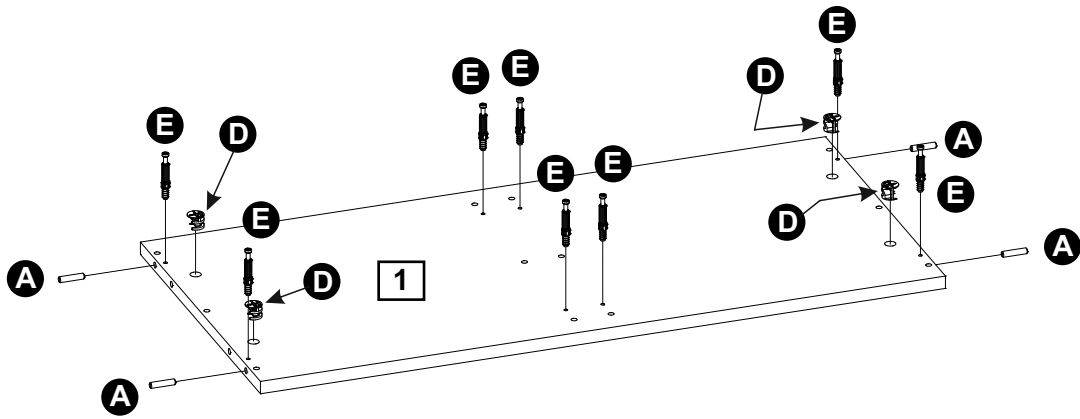
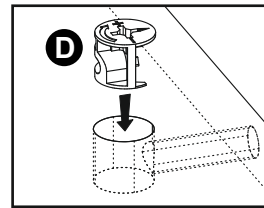
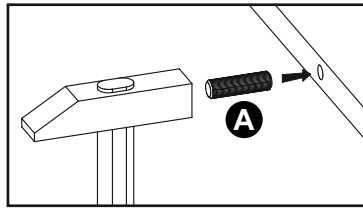
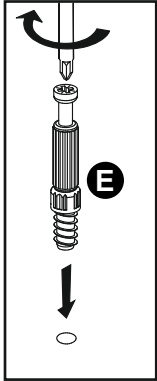
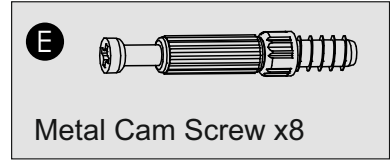
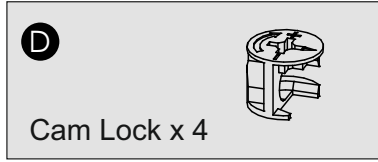
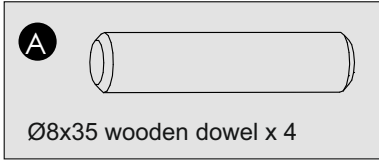

# 2

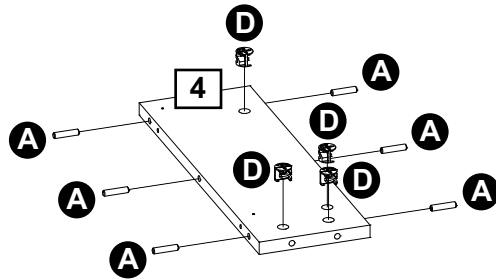
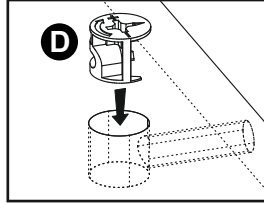
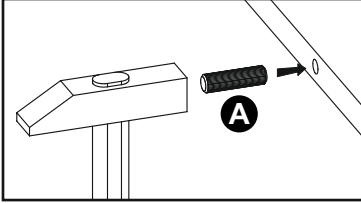
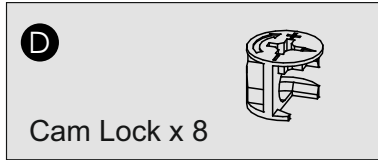
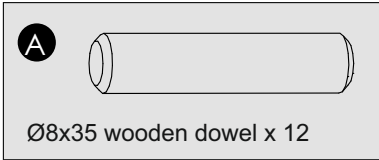

 Repeat  
x2

# 3

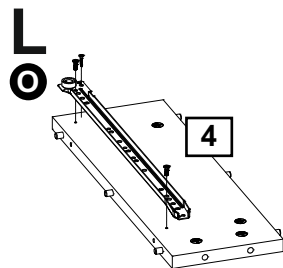
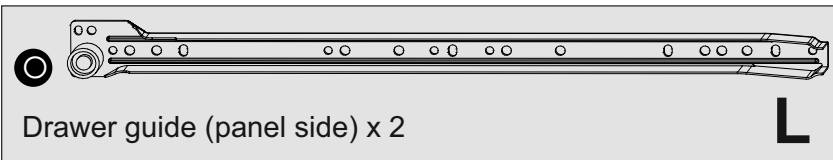
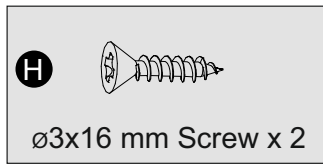

 Repeat  
x2

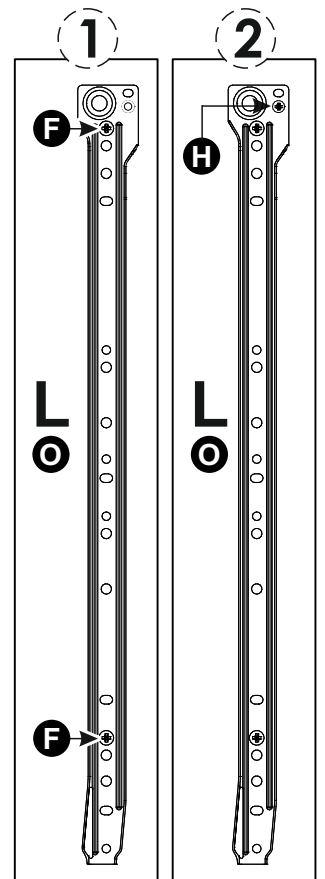



# 4

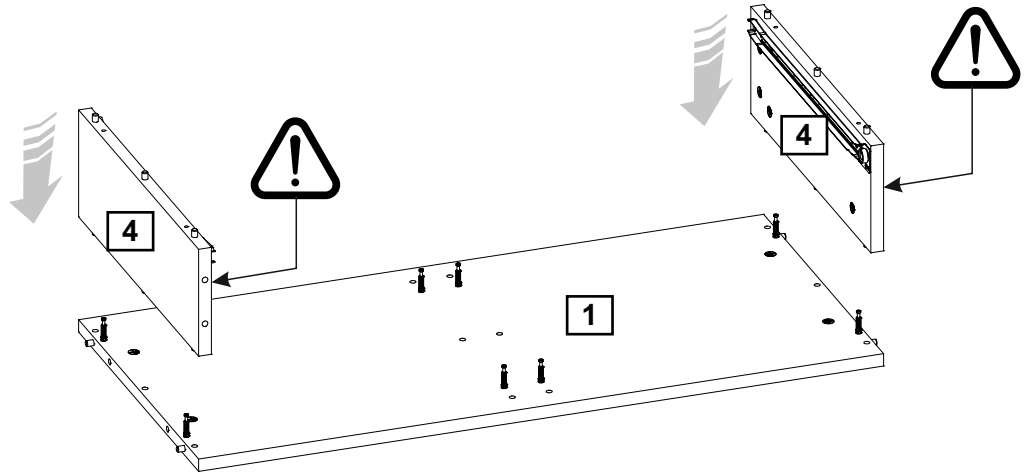
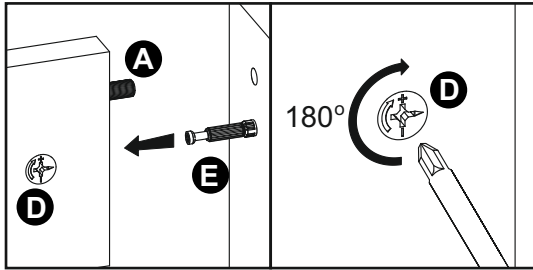

# 5

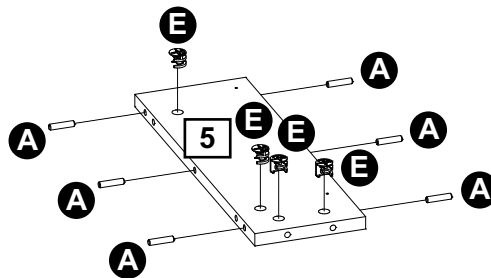
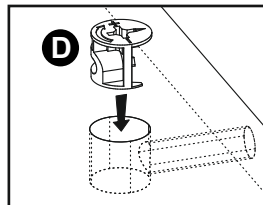
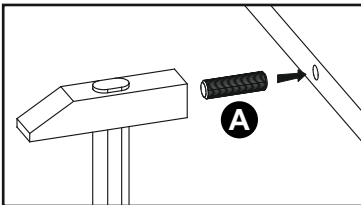
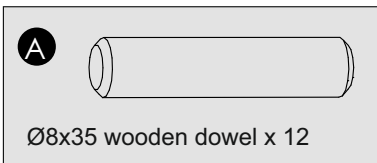

 Repeat  
x2

# 6

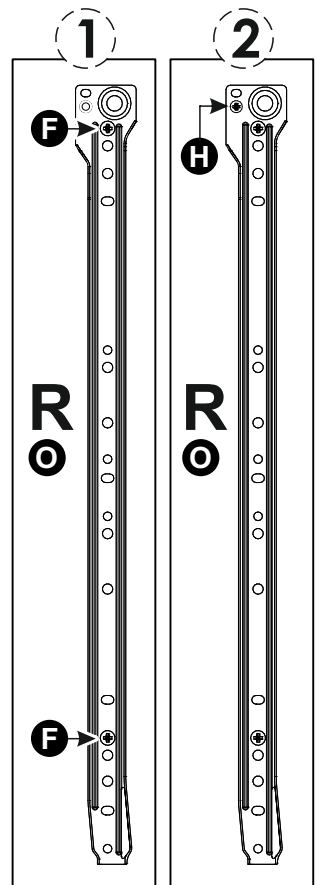
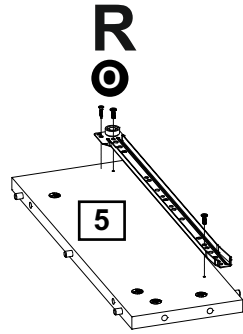
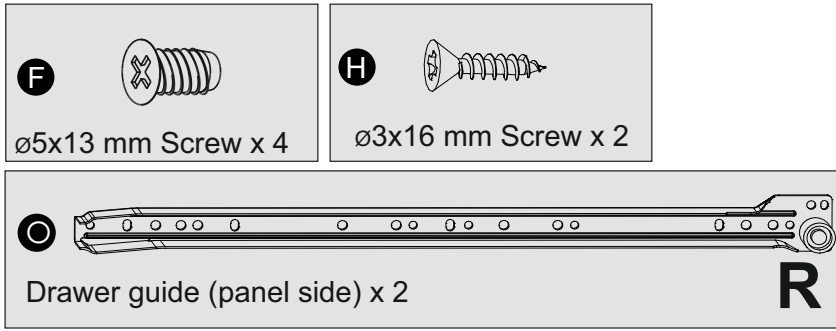

# 7

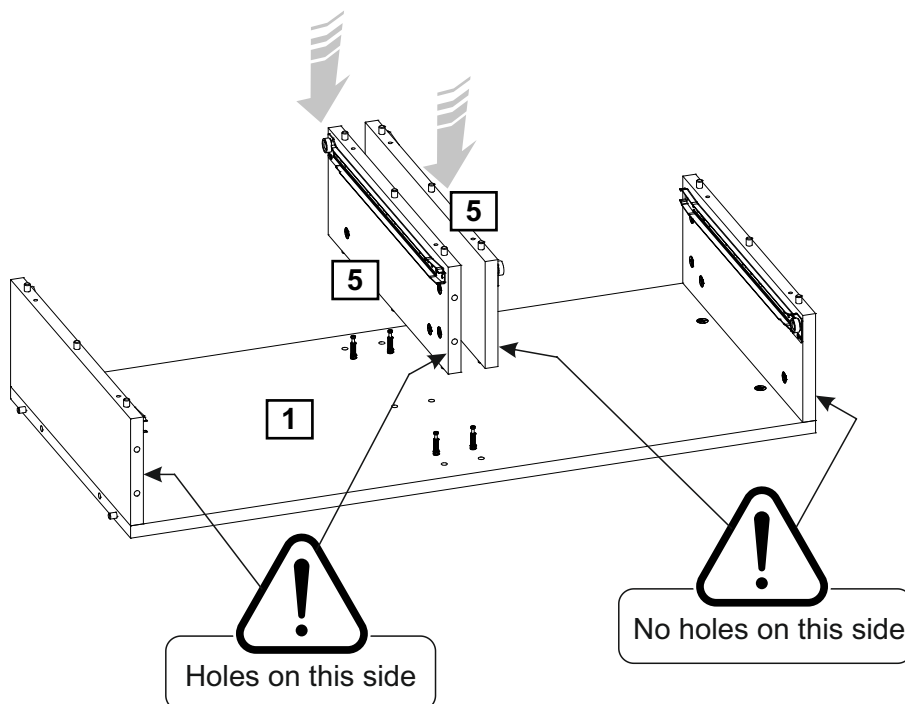
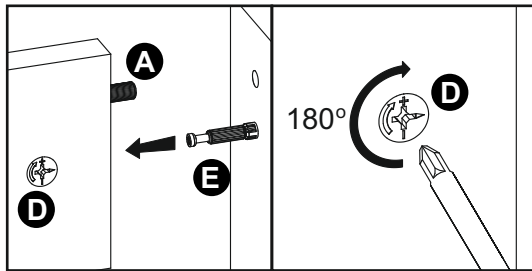

# 8

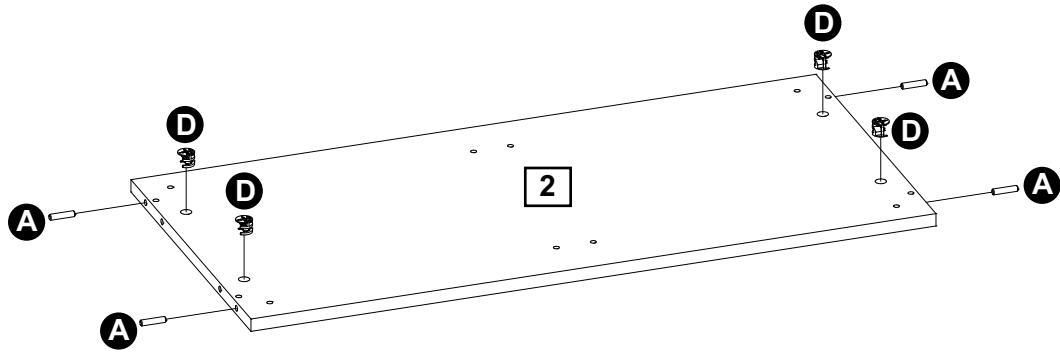
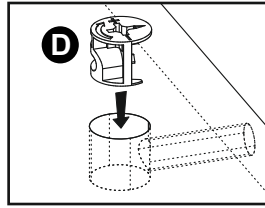
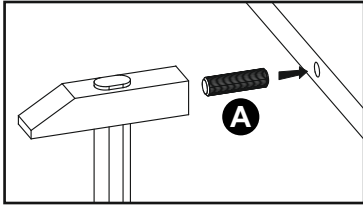
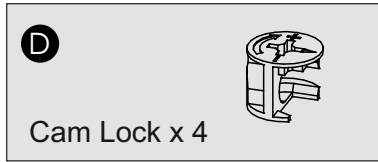
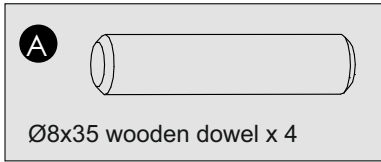

# 9

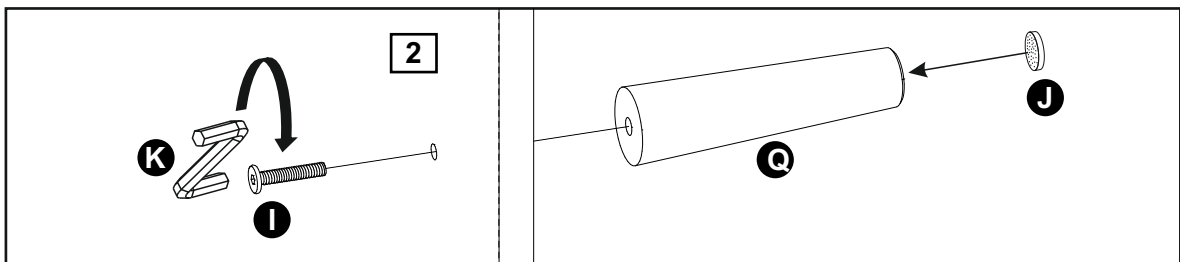
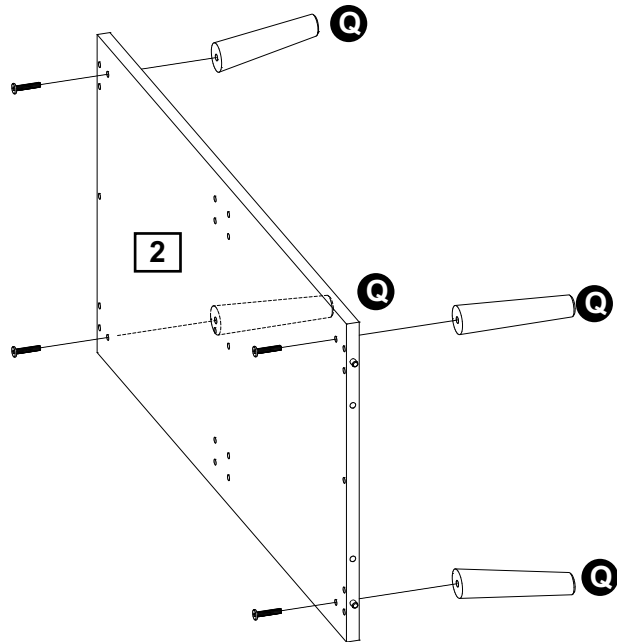
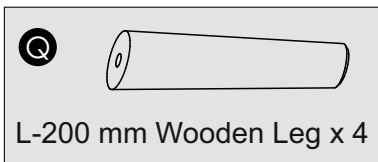
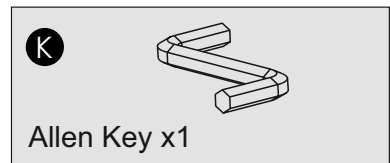
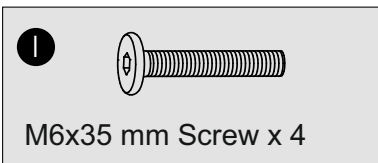

# 10

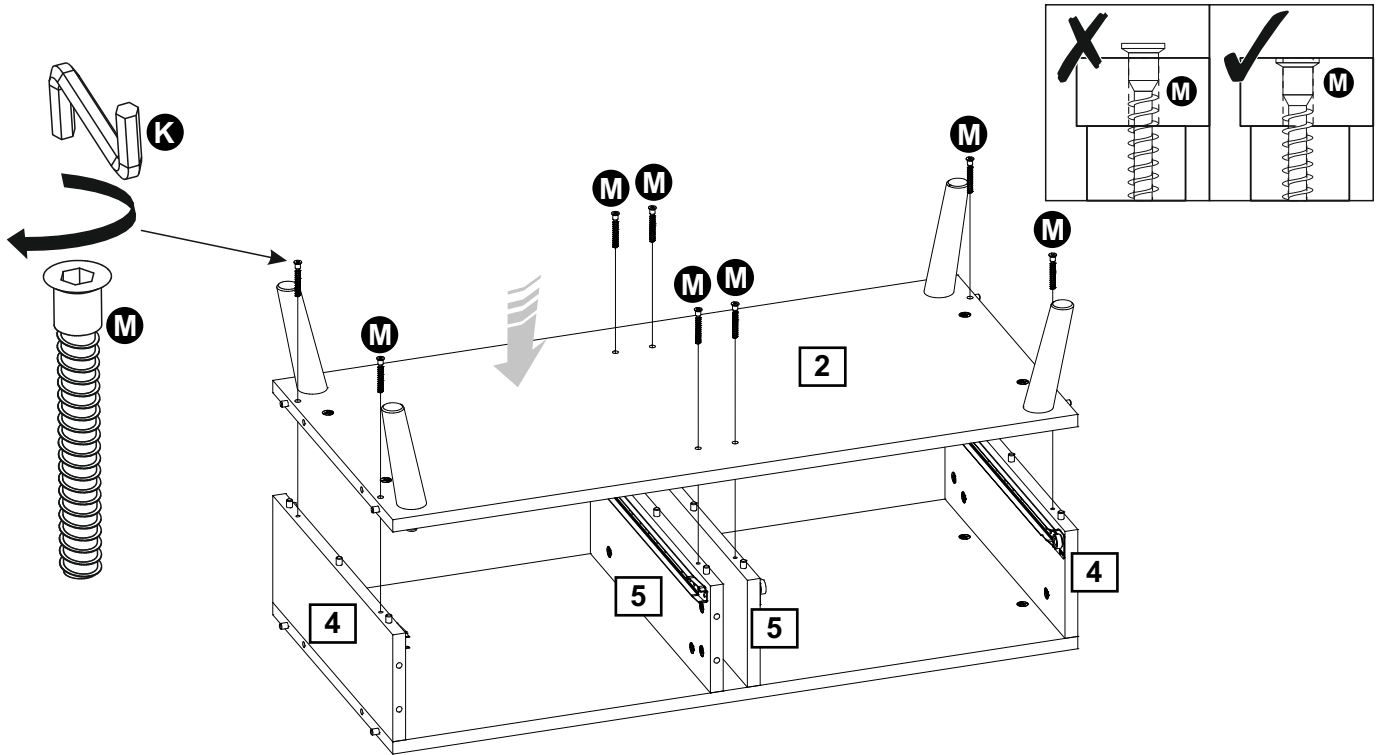
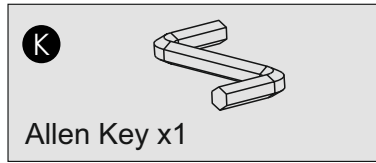
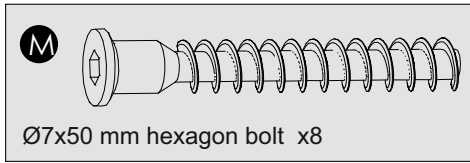

# 11

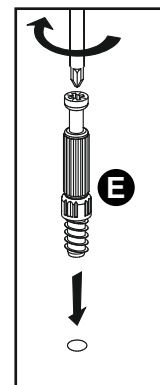
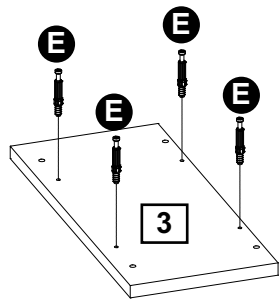
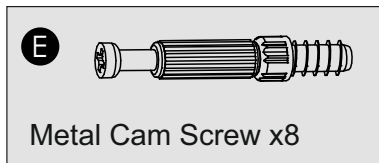

 Repeat x2

# 12

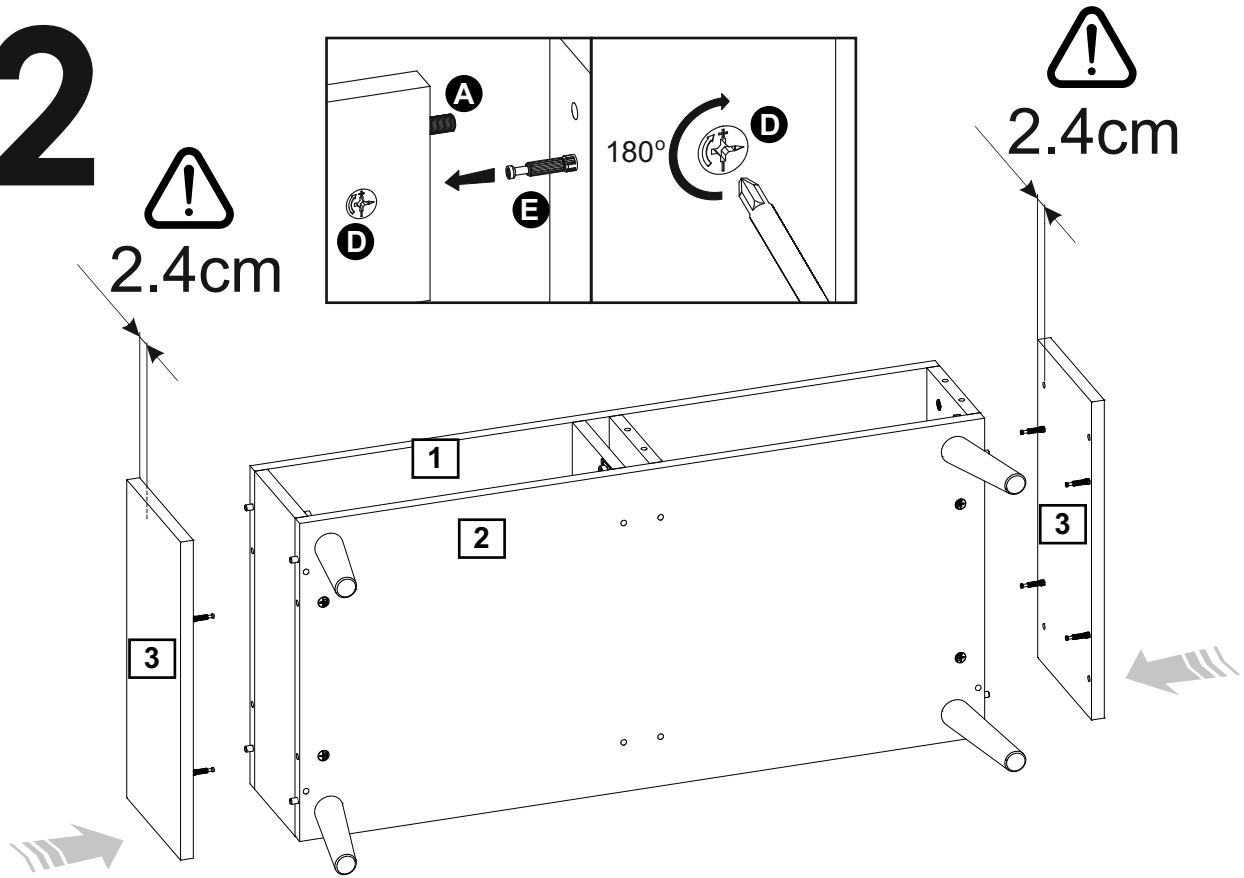

# 13

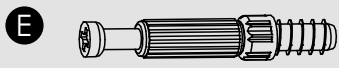

Metal Cam Screw x8

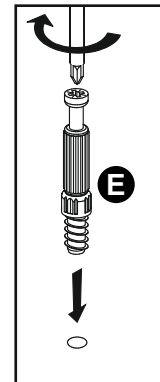
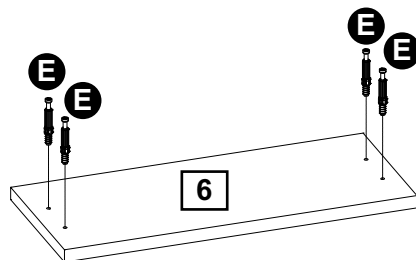

Repeat  
x2

# 14

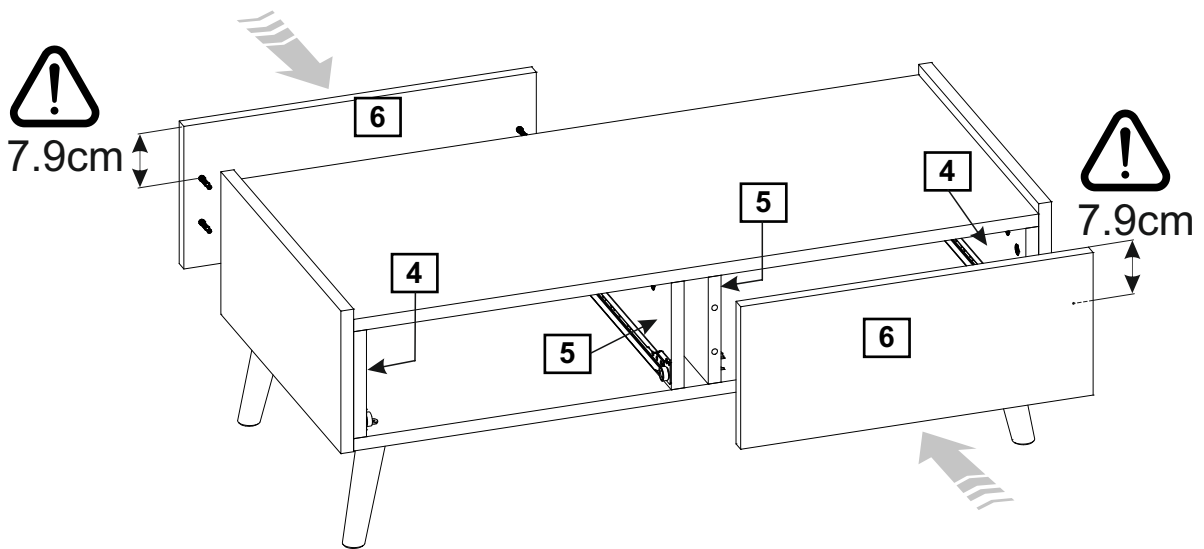
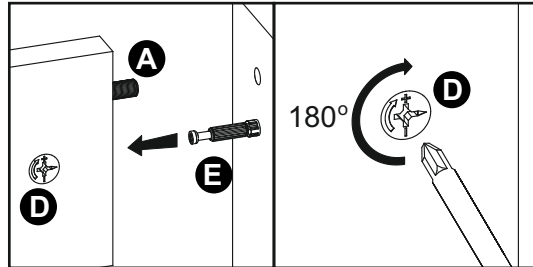

# 15

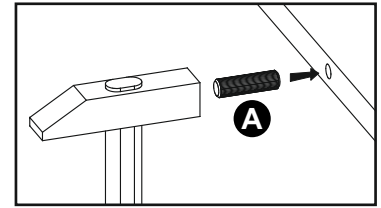
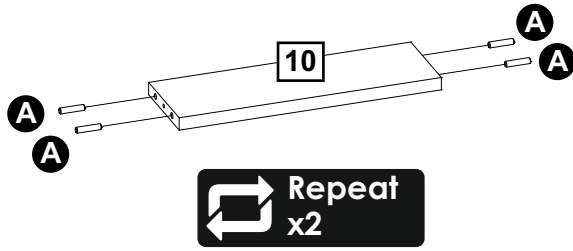
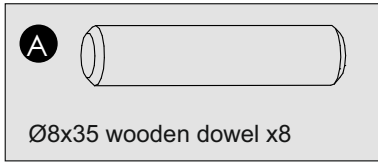

# 16

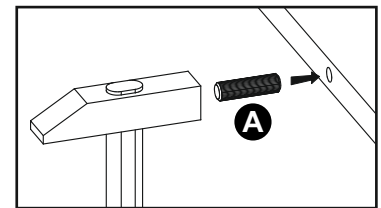
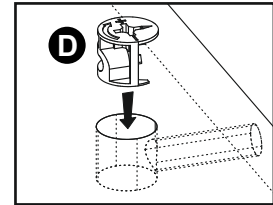
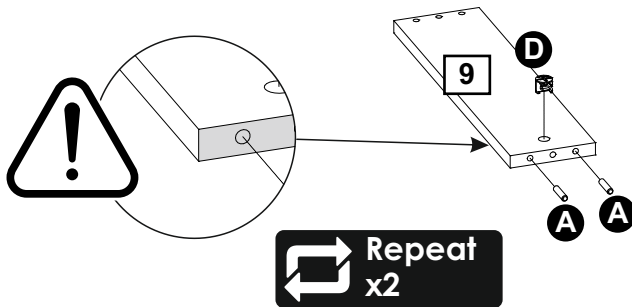
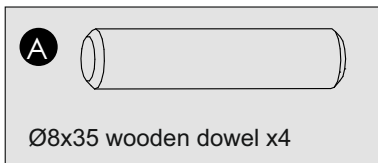

# 17

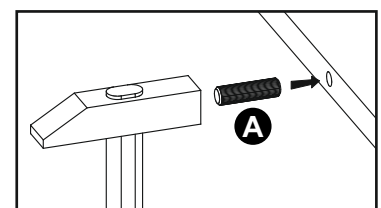
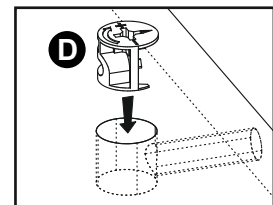
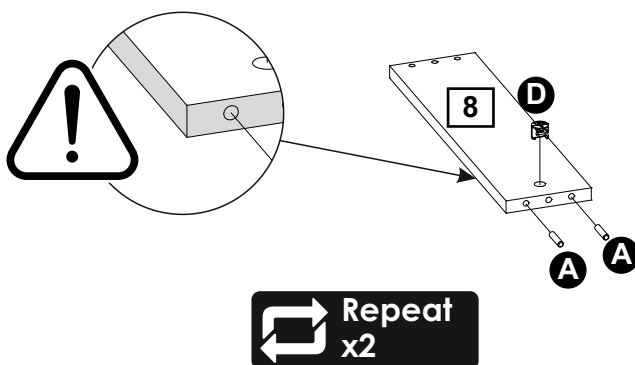
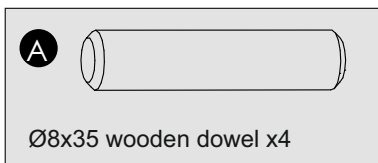

# 18

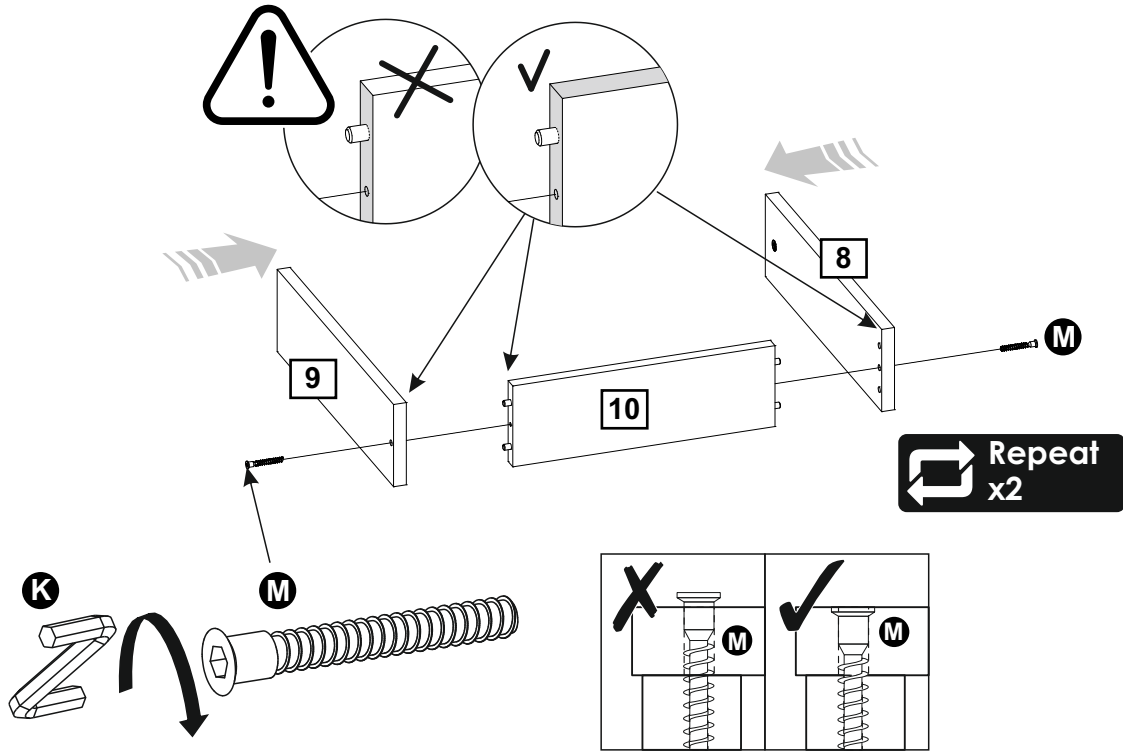
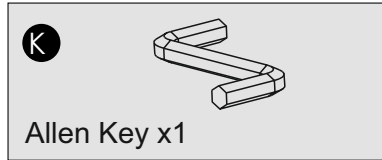
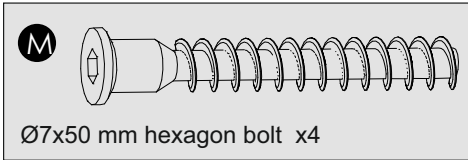

# 19

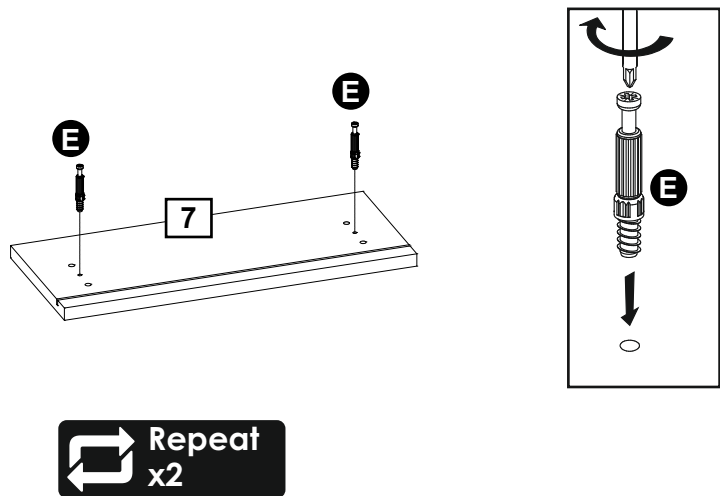
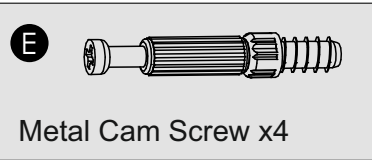



# 20

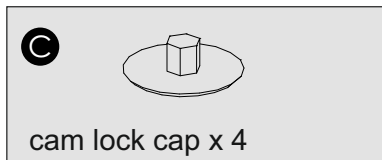

Repeat  
x2

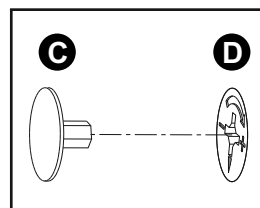
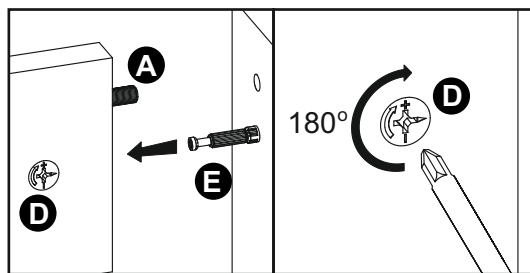
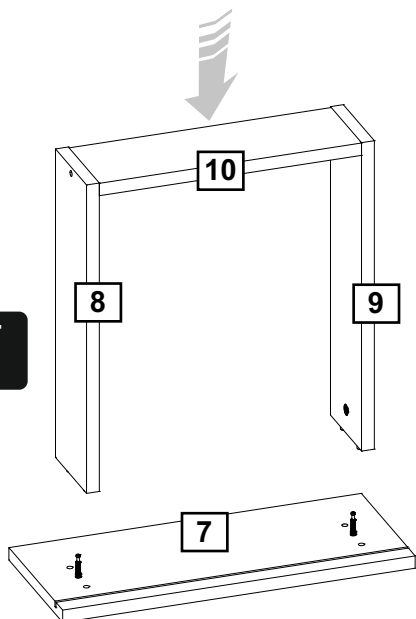

# 21

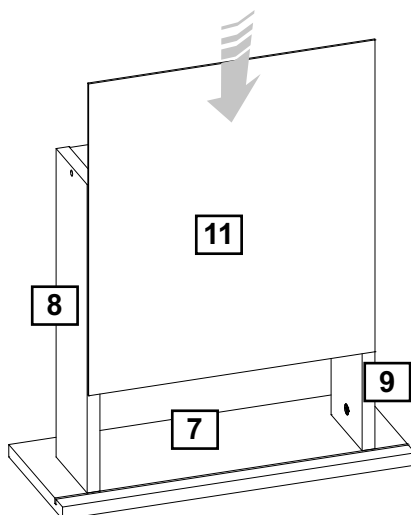

Repeat  
x2

# 22

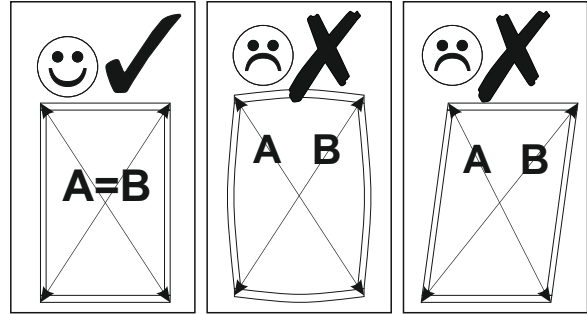
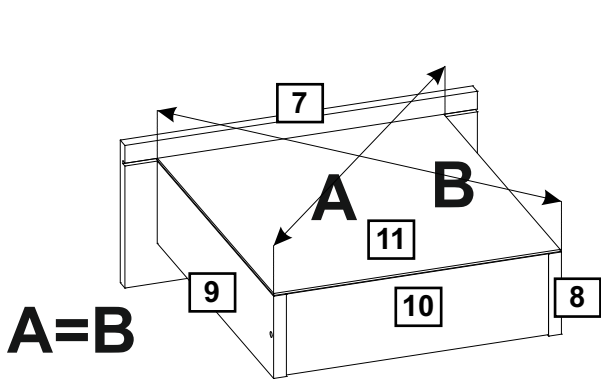

 Repeat  
x2

# 23

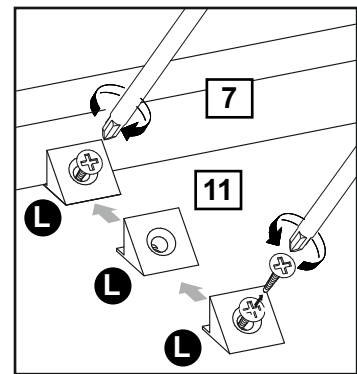
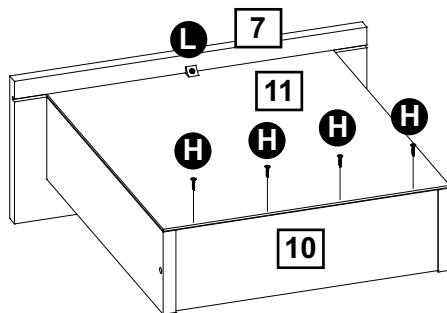
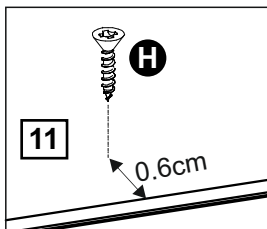
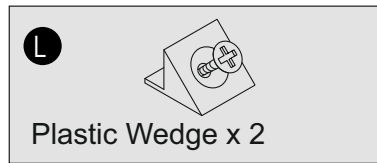
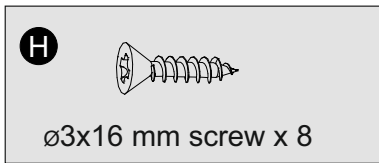



 Repeat  
x2

# 24

**B**   
ø3x20 mm Screw x12

**G**   
Bumper x 4

**P**   
Drawer guide (drawer side) x 2 **L**

**P**   
Drawer guide (drawer side) x 2 **R**

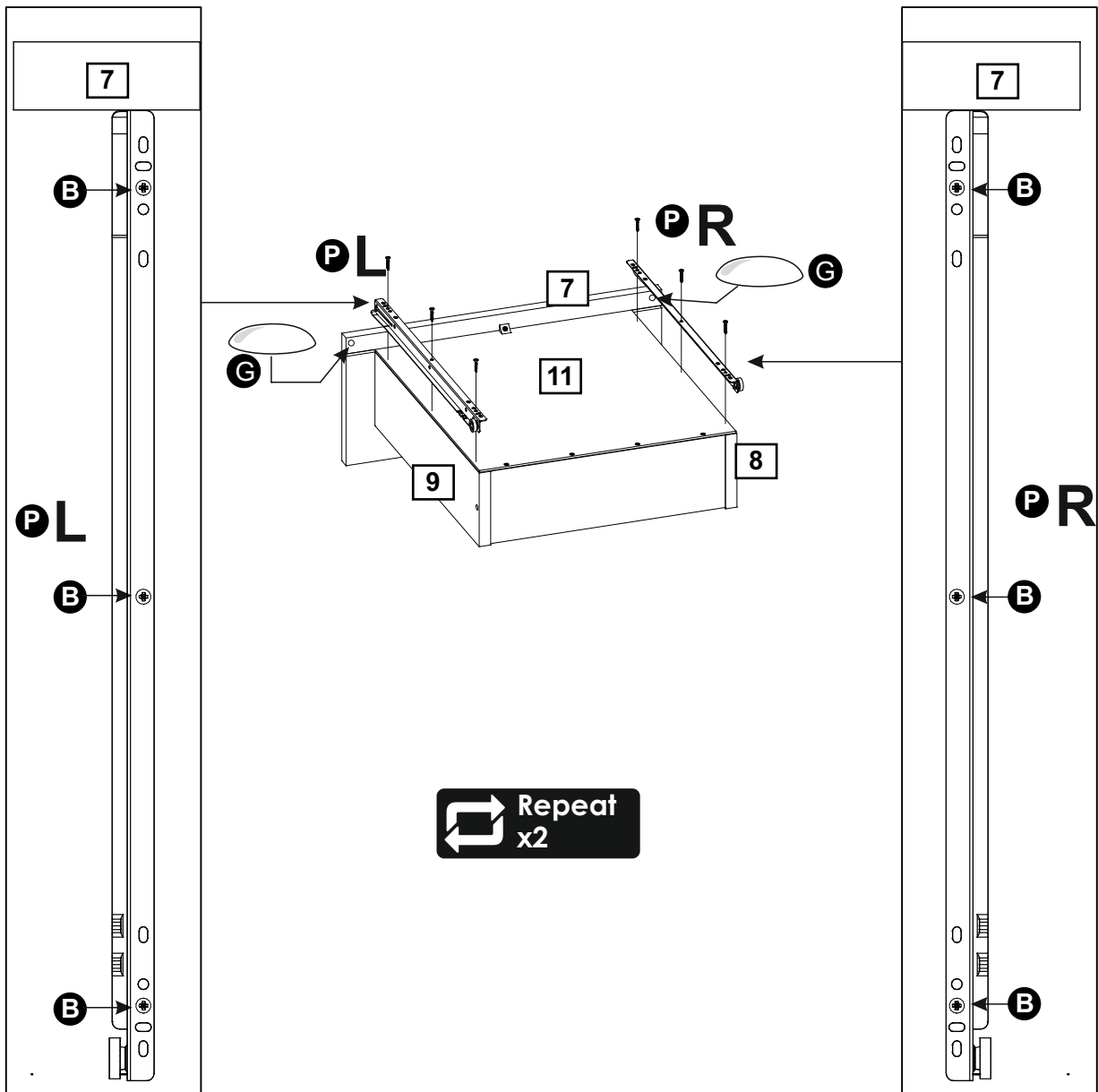

# 25

