

8 X Interlocking White Shoe Storage

Assembly Instructions - Please keep for future reference

343/3980

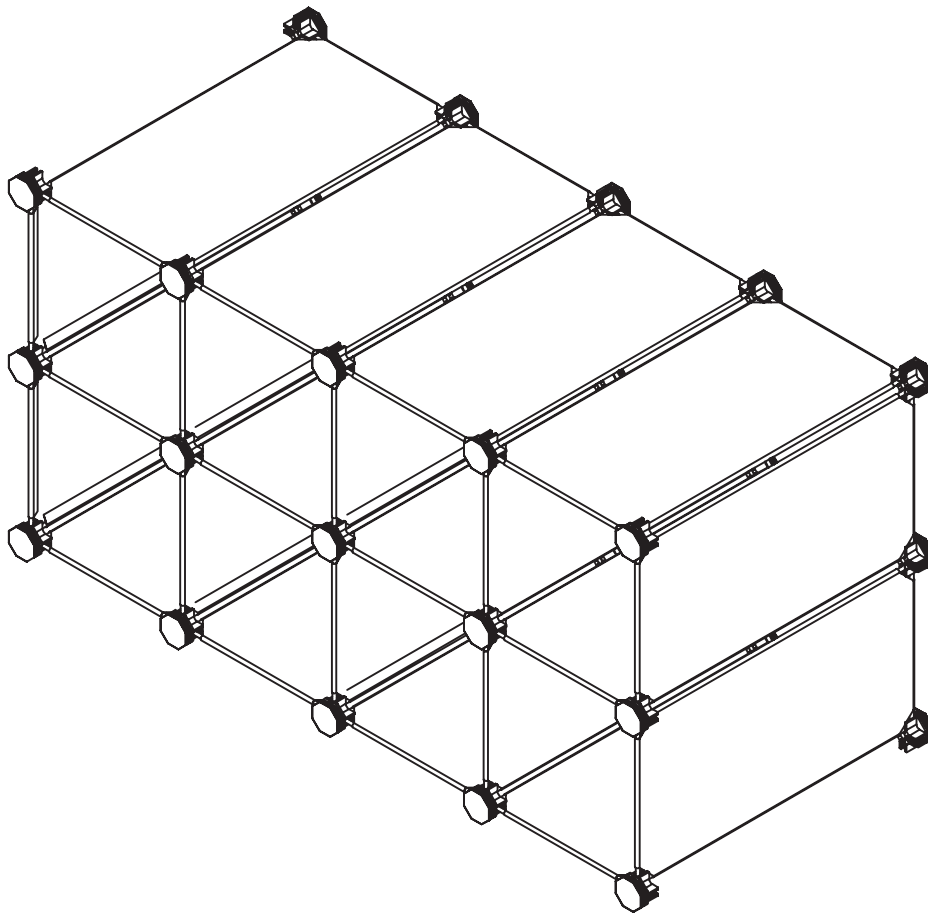

Dimensions

Width - 81cm
Depth - 37.5cm
Height - 42cm

Important – Please read these instructions fully before starting assembly

If you need help or have damaged or missing parts, call the **Customer Helpline: 03456 400800**



Safety and Care Advice

Important – Please read these instructions fully before starting assembly

- Check you have all the components and tools listed on the following pages.
- Remove all fittings from the plastic bags and separate them into their groups.
- Keep children and animals away from the work area, small parts could choke if swallowed.
- Make sure you have enough space to layout the parts before starting.

- During assembly do not stand or put weight on the product, this could cause damage.
- Assemble the item as close to its final position (in the same room) as possible.
- Assemble on a soft level surface to avoid damaging the unit or your floor.
- Parts of the assembly will be easier with 2 people.



- To reduce the likelihood of damaging your product please ensure that your power drill is set on a low torque setting.

Care and maintenance

- Only clean using a damp cloth and mild detergent, do not use bleach or abrasive cleaners.
- From time to time check that there are no loose screws on this unit.
- This product should not be discarded with household waste. Take to your local authority waste disposal centre.

Handy Hints

- To ensure that each PP board is well connected with connector, Please use the hammer for help.

Components - Parts

If you have damaged or missing components, call the **Customer Helpline: 03456 400800**

Please check you have all the fittings listed below

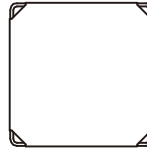

1 Rectangle PP board x 22

2 Square PP board x 8

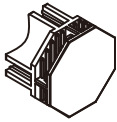

3 Connector x 30

Components - Fittings

Tools required

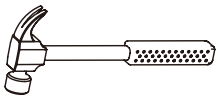

Hammer

Assembly Instructions

Step 1

Important Note: Please follow the step 1 to make one cube first and you can easily finish the rest of cubes.

Connect Connector **3** with Rectangle PP Board **1**.

See Fig 1.

Connect Rectangle PP Board **1** along with Square PP Board **2**.

Connect Connector **3**.

Connect Rectangle PP Board **1**.

Connect Connector **3**.

Finally, you made the complete cube.

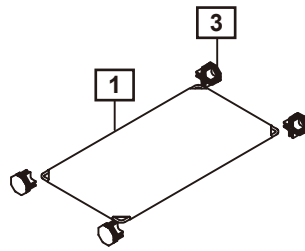

Fig 1.

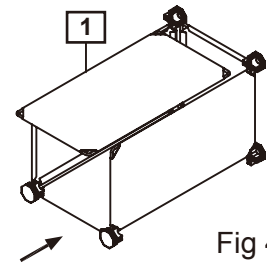

Fig 4.

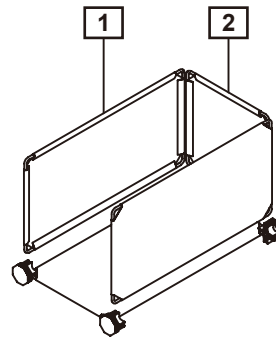

Fig 2.

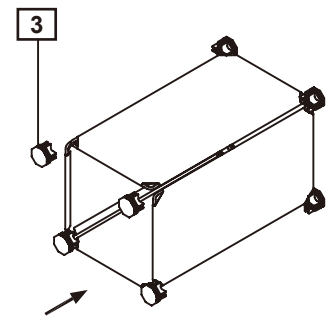

Fig 5.

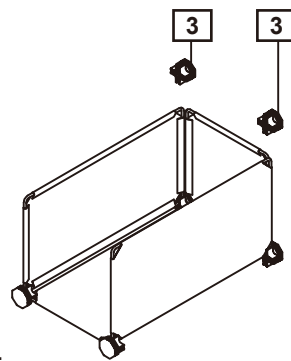
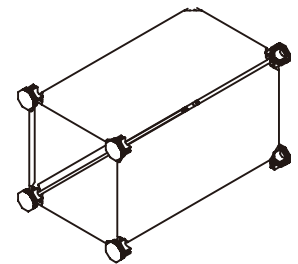

Fig 3.



Step 2

Please refer to step 1 fig 2 to fig 5 for the rest of cubes.

See Fig.6.

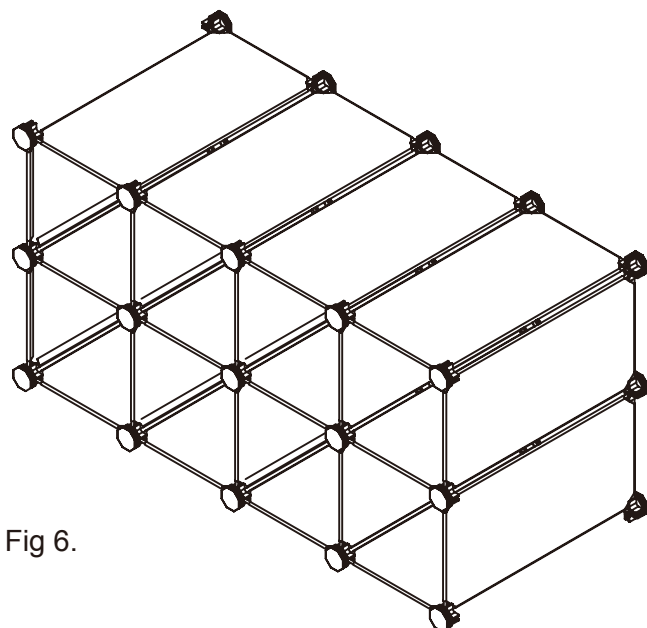

Fig 6.