

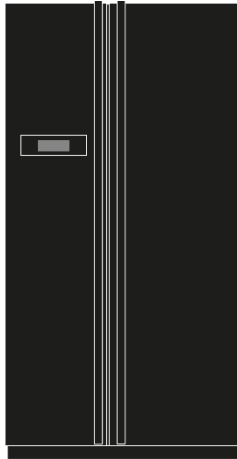

Russell Hobbs

**Freestanding 90cm Wide 176cm
High Fridge Freezer
User Guide**



**Model number:
RH90FF176(B)(R)(SS)(W)**

For Customer Services & Spare Parts please call **0345 208 8750**
Opening times: Monday - Friday 8am – 8pm & Saturday 9am – 1pm
or visit us at www.productcare.co.uk

**IMPORTANT:
RETAIN FOR FUTURE REFERENCE**

Contents

Safety Instructions	3 - 4
Before Switching On	4
Installing and Switching on Your Appliance	5
Your Appliance and the Compartments	6
Unit & Spare Parts	7
Transportation and Handling	8
Where to Put Your Appliance	8
Installation	9 - 10
Usage Information	11 - 18
Cleaning and Maintenance	19
Bulb Replacement	20
Reversing the Door	20
Troubleshooting	21- 22
Important Notes	23
Product Specification	23
Connection to the Mains Supply	24
Guarantee	25
Notes	26 – 27



Russell Hobbs

For Customer Services & Spare Parts please call **0345 208 8750**
Opening times: Monday - Friday 8am – 8pm & Saturday 9am – 1pm
or visit us at www.productcare.co.uk

Before Using the Appliance

Safety Instructions

- The model contains R600a (the coolant, Isobutene), a natural refrigerant gas that is environmentally friendly but also combustible. When transporting and installing the unit, care must be taken to ensure that none of the refrigeration circuit components are damaged. In the event of damage avoid naked flames or ignition sources and ventilate the room in which the unit is placed for a few minutes. Contact a local service engineer.

Warning: Keep ventilation openings in the appliance enclosure or structure clear of obstruction.

- The appliance must not be placed or rested on the power cord.
- Do not use mechanical devices or other artificial means to accelerate the defrosting process.
- Do not use electrical appliances in the refrigerator compartment of the appliance.
- If this appliance is to replace an old refrigerator with a lock, the lock must be removed as a safety measure before storing it or disposing of it. This is to protect children from locking themselves inside the appliance.
- Old refrigerators and freezers contain insulation gases and refrigerant, they must be disposed of properly. Entrust the disposal of the scrap unit categorically to the competence of your local waste disposal service. Contact your local authority or your dealer if you have any questions. Please ensure that you do not damaged the scrap unit prior to being picked-up by the relevant waste disposal service.

Important Note:

Please read this booklet before installing and switching on this appliance. The manufacturer assumes no responsibility for incorrect installation and usage as described in this booklet.



Russell Hobbs

For Customer Services & Spare Parts please call **0345 208 8750**
Opening times: Monday - Friday 8am – 8pm & Saturday 9am – 1pm
or visit us at www.productcare.co.uk

Safety Instructions

Warning:

- This appliance can be used by children aged from 8 years and above and persons with reduced physical, sensory or mental capabilities or lack of experience and knowledge if they have been given supervision or instruction concerning use of the appliance in a safe way and understand the hazards involved. Children should not play with the appliance.
- Do not use adaptors, multiple receptacles or extension leads.
- Do not plug in damaged plugs.
- Do not pull, twist or damage the power cable.
- Do not put the appliance or any other objects on the power cord.
- This appliance is designed to be used by adults, do not allow children to play with the appliance or let them hang over the door.
- Do not plug-in or un-plug the appliance with wet hands to prevent electrical shock.
- Do not place explosive or flammable material in your fridge for your own safety.
- Bottles containing a high percentage of alcohol must be sealed well and placed vertically in the refrigerator.
- Do not cover the body or the top of the appliance with lace. This affects the performance of your fridge.
- Fix down the accessories in the fridge during transportation to prevent damage to them.

Before Switching On:

- **Let the appliance rest for 3 hours before plugging into the main power to ensure proper performance.**
- **There may be an odour when you first switch on the appliance, this is normal and should disappear when the appliance starts to cool.**
- **Before using your appliance, add a teaspoon of bicarbonate of soda to warm water and with a damp cloth wipe down all parts of the new appliance, then repeat the process with a clean damp cloth and dry.**
- **ENSURE THE APPLIANCE IS NOT CONNECTED TO THE POWER WHEN PERFORMING THIS TASK**



Russell Hobbs

For Customer Services & Spare Parts please call **0345 208 8750**
Opening times: Monday - Friday 8am – 8pm & Saturday 9am – 1pm
or visit us at www.productcare.co.uk

Installing and Switching on Your Appliance

- Operating voltage for your fridge is 220-240V at 50Hz.
- If you need help or are unsure how to install the unit, please contact Customer Services on 0345 208 8750 or visit www.productcare.co.uk.
- Before plugging in the power supply, ensure that the voltage on the rating label corresponds to the working voltage of your electrical system in your home.
- Insert the plug into an efficient Ground (Earth) connection. If the socket has no Ground (Earth) contact or the plug does not match, we suggest you call an authorised electrician for assistance.
- We do not take responsibility for damages that occur due to Ungrounded (Un-earthed) usage.
- Place your appliance in an area that is not exposed to direct sunlight.
- Your appliance should be placed at least 10cm away from stoves, ovens and other heating cores.
- It should never be used outdoors or left in the rain.
- When your appliance is placed next to a chest freezer or freezer, there should be at least 10cms between them to prevent humidity on the outer surface.
- Do not place anything on your appliance and install the unit in a suitable place so that there is at least 30cm clearance above the appliance.
- If placing your appliance next to kitchen cabinets, leave 10cm between them.
- The rear of the appliance should be at least 10cm away from the back wall.
- The appliance must be used in the vertical position and on a flat surface.
- To level the appliance, use the adjustable feet on the front of the appliance.
- Do not place your appliance on a carpeted surface as this will prevent adequate ventilation.
- Do not place hot food or containers in the fridge as this can cause damage your appliance.



Russell Hobbs

For Customer Services & Spare Parts please call **0345 208 8750**
Opening times: Monday - Friday 8am – 8pm & Saturday 9am – 1pm
or visit us at www.productcare.co.uk

Your Appliance and the Compartments

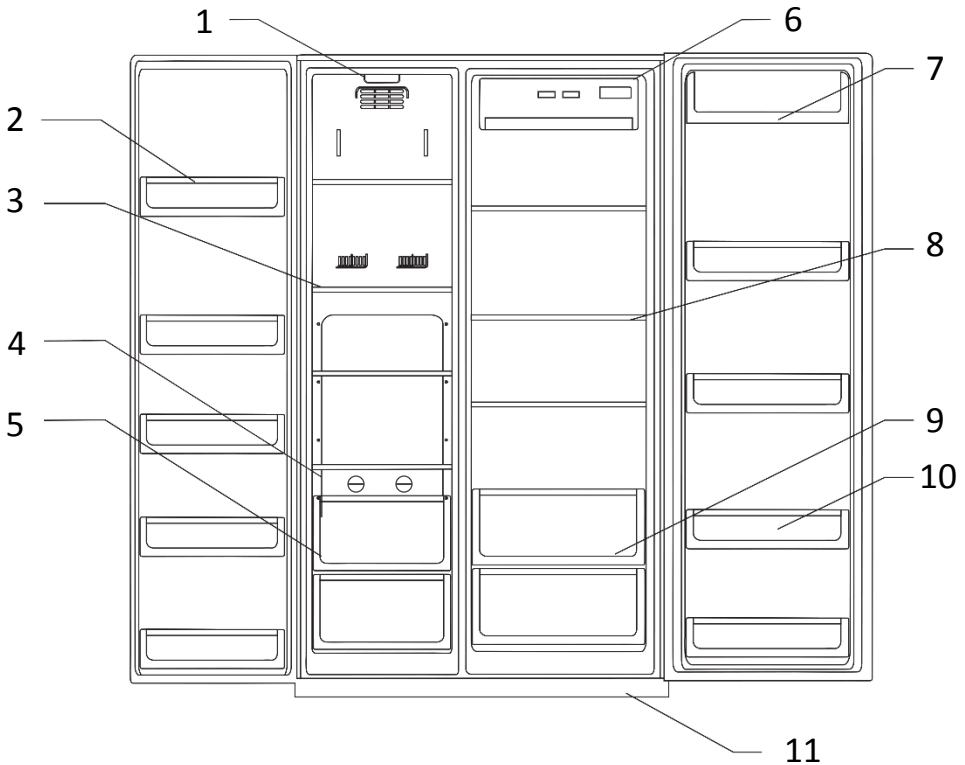

- | | | | |
|----|-----------------------|-----|-------------------------|
| 1. | Freezer light | 6. | Fridge light |
| 2. | Freezer door rack | 7. | Dairy compartment |
| 3. | Glass shelf (freezer) | 8. | Glass shelf (fridge) |
| 4. | Ice cube drawer | 9. | Fridge drawer / crisper |
| 5. | Freezer drawer | 10. | Fridge door rack |
| | | 11. | Lower cover |

The lower cover is fitted by 3 screws, you will need a crosshead screwdriver for this.

Parts may vary according to the appliance model.



Russell Hobbs

For Customer Services & Spare Parts please call **0345 208 8750**
Opening times: Monday - Friday 8am – 8pm & Saturday 9am – 1pm
or visit us at www.productcare.co.uk

Unit & Spare Parts

For the following spares please contact customer service on
0345 208 8750 or visit www.productcare.co.uk

Item	Quantity
Freezer light/bulb	1
Freezer door rack	5
Freezer glass shelf	3
Ice cube drawer	1
Freezer drawer	2
Fridge light/bulb	1
Fridge door rack	4
Fridge glass shelf	4
Wine rack	1
Fridge drawer	2
Lower cover & screws	1
Instruction booklet	1
Screws	3



Russell Hobbs

For Customer Services & Spare Parts please call **0345 208 8750**
Opening times: Monday - Friday 8am – 8pm & Saturday 9am – 1pm
or visit us at www.productcare.co.uk

Transportation and Handling

For safe lifting, tilt the appliance backwards by no more than 45 degrees, hold the base and rear corners of cabinet. Lift the refrigerator carefully. Never use the door handles for lifting. To move the refrigerator on a flat level surface, tilt it slightly backwards onto the two rear moulded feet and push backwards.

This unit is heavy and could cause injury – We recommend 2 person handling

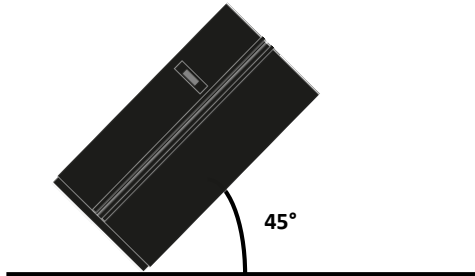

Where to put your appliance

1. This appliance should only be placed on a flat, solid surface.
2. Do not place your appliance on a carpeted surface as this will prevent adequate ventilation.
3. Choose a dry and well-ventilated space. No less than 10cms must be left around the sides to allow sufficient cooling.
4. Choose a location away from a heat source, e.g. direct sunlight, a radiator or oven, etc.
5. The appliance should be positioned so that the plug is easily accessible.
6. The appliance should not be on top of the power cord.

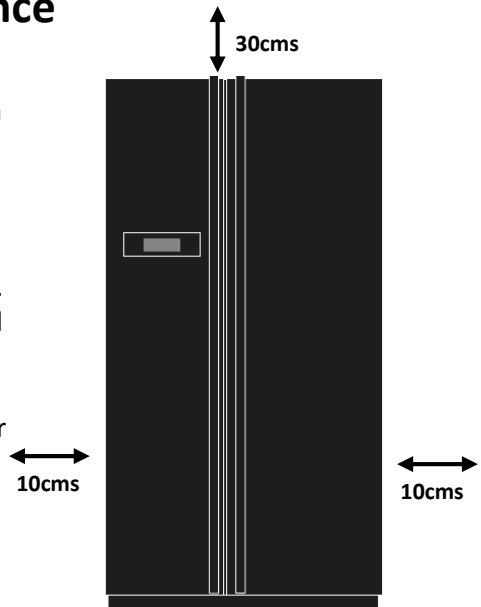

 Russell Hobbs

For Customer Services & Spare Parts please call **0345 208 8750**
Opening times: Monday - Friday 8am – 8pm & Saturday 9am – 1pm
or visit us at www.productcare.co.uk

Installation

- After installation, do not switch the power to the refrigerator on for at least 3 hours. The coolant within the product needs time to settle after it has been transported and put in to position, failure to do this will affect the cooling performance of your appliance.
- The unit should be kept away from direct sunlight.
- Remove all transport tapes and foam protection pieces . Clean the interior of the appliance with a cloth dampened in lukewarm soap and water. Wipe with clear water and wipe dry.
- When the appliance has been positioned, adjust the two front feet to ensure the unit is stable. This is essential to ensure quiet running and proper door opening /closing. See figure below.

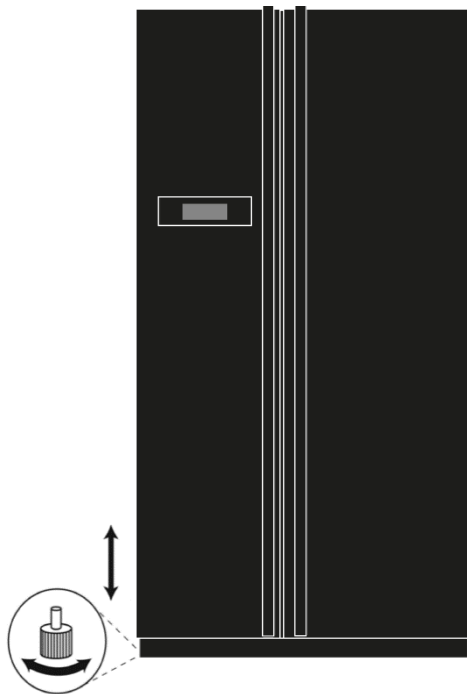

 Russell Hobbs

For Customer Services & Spare Parts please call **0345 208 8750**
Opening times: Monday - Friday 8am – 8pm & Saturday 9am – 1pm
or visit us at www.productcare.co.uk

Installation

- Open the fridge door and take out the lower cover and the 3 screws that are packaged with the instruction manual. Then line the 3 holes in the lower cover with the 3 holes at the bottom of the refrigerator and tighten the screws.

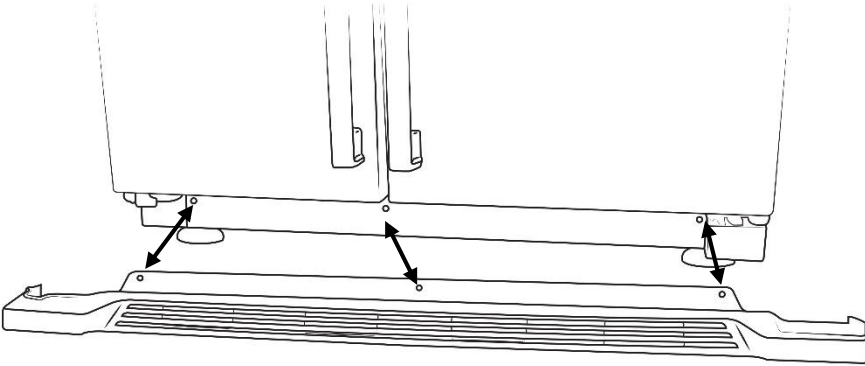

- Once the appliance has been standing for 3 hours, plug in the refrigerator, switch on the electricity and set the required fridge and freezer temperatures (please see page 16). The compressor will begin to work.
- Leave the appliance for a minimum of 3 hours for the correct temperature to be reached before placing food inside.



Russell Hobbs

For Customer Services & Spare Parts please call **0345 208 8750**
Opening times: Monday - Friday 8am – 8pm & Saturday 9am – 1pm
or visit us at www.productcare.co.uk

Usage Information

Control panel

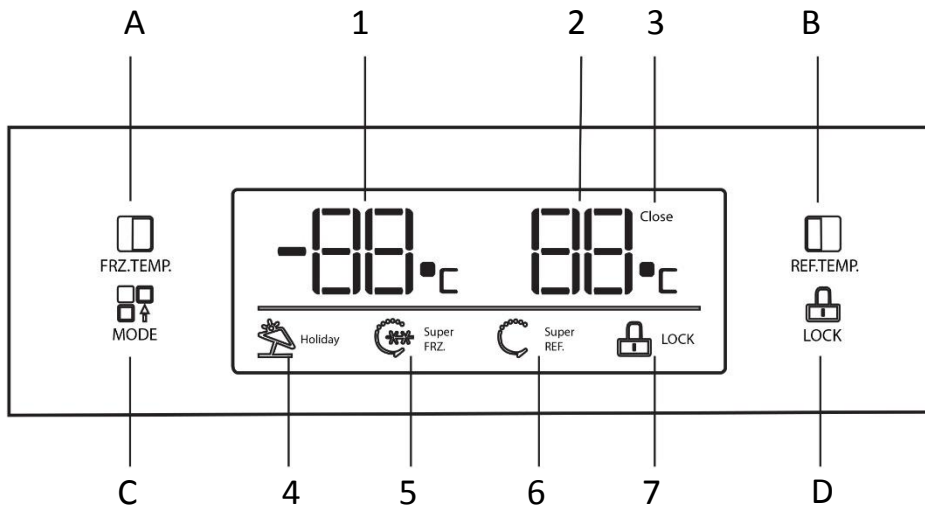

Display

- | | | | |
|----|---------------------------------|----|--------------|
| 1. | Freezer compartment temperature | 5. | Super freeze |
| 2. | Fridge compartment temperature | 6. | Super cool |
| 3. | Close icon | 7. | Lock |
| 4. | Holiday icon | | |

Button operation

- | | | | |
|----|--|----|--------------|
| A. | Freezer compartment temperature adjustment | C. | Mode setting |
| B. | Fridge compartment temperature adjustment | D. | Lock/unlock |



Russell Hobbs

For Customer Services & Spare Parts please call **0345 208 8750**
Opening times: Monday - Friday 8am – 8pm & Saturday 9am – 1pm
or visit us at www.productcare.co.uk

Usage Information

Important note: The display will only be illuminated when a button is pressed or a compartment door opened, at all other times the display will be in a standby state.

Important note: The control panel will automatically lock itself. Before adjusting the temperature or selecting any model the panel must be unlocked by pressing and holding the lock button for 4 seconds until the lock symbol disappears from the display.

Freezer compartment temperature adjustment FRZ.TEMP.

To change the temperature of the freezer compartment, press the freezer temperature button. The temperature of the freezer can be set between -16°C and -24°C.

Press the freezer temperature icon until the required temperature is shown on the display. Please note that during the temperature setting process and for sometime after the freezer temperature on the display will flash. It will then stop flashing and the display will be automatically locked (it will stop flashing before the required temperature has been reached).

Freezer compartment temperature

The freezer compartment temperature will be shown on the display when a compartment door is opened or a button is pressed.

Fridge compartment temperature adjustment REF.TEMP.

To change the temperature of the fridge compartment, press the fridge temperature button. The temperature of the fridge can be set between 2°C and 8°C.



Russell Hobbs

For Customer Services & Spare Parts please call **0345 208 8750**
Opening times: Monday - Friday 8am – 8pm & Saturday 9am – 1pm
or visit us at www.productcare.co.uk

Usage Information

Press the fridge temperature icon until the required temperature is shown on the display. Please note that during the temperature setting process and for sometime after the freezer temperature on the display will flash. It will then stop flashing and the display will be automatically locked (it will stop flashing before the required temperature has been reached).

Fridge compartment temperature

The freezer compartment temperature will be shown on the display when a compartment door is opened or a button is pressed.

Mode settings

The appliance has 4 pre-set modes that can be selected and these are:

- **Holiday**
- **Super freeze**
- **Super freeze & cool**
- **Super cool**

Holiday mode

This mode is designed to prevent your appliance from wasting energy during times when it's not in regular use (when you are on holiday for example). By selecting this function the temperature of the freezer compartment will automatically be set to -18°C and the fridge compartment will be turned off (the close icon will be shown on the display).

To use the holiday mode you must press the mode button until the holiday icon is lit on the display. To exit the holiday mode press the mode button until no model icon is lit on the display.

Important note: If this mode is selected then all food and drinks must be removed from the fridge compartment



For Customer Services & Spare Parts please call **0345 208 8750**
Opening times: Monday - Friday 8am – 8pm & Saturday 9am – 1pm
or visit us at www.productcare.co.uk

Usage Information

Super freeze



This mode is designed for when freezing items that are not already pre-frozen. If you are placing fresh food inside the freezer then ideally you should have lowered the temperature beforehand ready to accommodate it and facilitate as quick a freeze as possible. You may need to pre select the super freeze mode as early as 12 hours before. By selecting this function the temperature of the freezer compartment will automatically be set to -24°C for a maximum of 26 hours (after this time the temperature will revert to what it was previously set at). If the temperature of freezer goes below -24°C during the 26 hours then the appliance will exit the super freeze mode automatically.

To use the super freeze mode you must press the mode button until the super freeze icon is lit on the display. To exit the super freeze mode press the mode button until no mode icon is lit on the display.

Super freezer & cool



This mode is designed for times when the refrigerator warms past the point of cooling, such as when the weather is extremely warm, the refrigerator doors are opened frequently, or a large batch of food is placed inside the refrigerator. In order to restore a colder temperature in the refrigerator, put the super cool setting on to set the unit to the coolest temperature. By selecting this function the temperature of the freezer and fridge compartments will automatically be set to -24°C and 2°C for a maximum of 26 hours for the freezer setting and 2 hours 30 minutes for the fridge setting (after this time the temperature will revert to what it was previously set at). If the temperature of freezer goes below -24°C during the 26 hours then the appliance will exit the super freeze mode automatically.



Russell Hobbs

For Customer Services & Spare Parts please call **0345 208 8750**
Opening times: Monday - Friday 8am – 8pm & Saturday 9am – 1pm
or visit us at www.productcare.co.uk

Usage Information

To use the super freeze and cool modes together you must press the mode button until the super freeze and cool icons are lit on the display. To exit the super freeze and cool mode press the mode button until no mode icon is lit on the display.

Super cool Super REF.

This mode is designed for times when the refrigerator warms past the point of cooling, such as when the weather is extremely warm, the refrigerator door is opened frequently, or a large batch of warm food is placed inside the refrigerator. In order to restore a colder temperature in the refrigerator, put the super cool setting on to set the unit to the coolest temperature. By selecting this function the temperature of the fridge compartment will automatically be set to 2°C for a maximum of 2 hours and 30 minutes (after this time the temperature will revert to what it was previously set at).

To use the super cool mode you must press the mode button until the super cool icon is lit on the display. To exit the super cool mode press the mode button until no mode icon is lit on the display.

Lock/unlock LOCK

To use the lock function you must press the lock button (the symbol on the display will be lit). This will cause all actions to be ignored, until the lock is removed.

To unlock the display and functions, hold the lock button for 4 seconds (the symbol on the display will be disappear).

Close icon Close

When lit it indicates that the fridge compartment as been turned off (this is automatically done in holiday mode).



Russell Hobbs

For Customer Services & Spare Parts please call **0345 208 8750**
Opening times: Monday - Friday 8am – 8pm & Saturday 9am – 1pm
or visit us at www.productcare.co.uk

Usage Information

Holiday icon  Holiday

When lit it indicates that the holiday mode has been activated

Lock icon  LOCK

When lit it indicates that the lock has been activated, no actions can be carried out until the child lock is de-activated



Russell Hobbs

For Customer Services & Spare Parts please call **0345 208 8750**
Opening times: Monday - Friday 8am – 8pm & Saturday 9am – 1pm
or visit us at www.productcare.co.uk

Usage Information

Temperature setting

- The temperature of the refrigerator is controlled electronically by control panel.
- To change the temperature of the fridge compartment, press the fridge temperature button. The temperature of the fridge can be set between 2°C and 8°C.
- To change the temperature of the freezer compartment, press the freezer temperature button. The temperature of the freezer compartment can be set between -16°C and -24°C.
- Setting the temperature of the fridge and the freezer can be done manually by pressing the fridge compartment temperature adjustment button and the freezer compartment temperature adjustment button until the required temperatures are shown on the display.
- Alternatively the temperatures of the fridge compartment, freezer compartment or both can be set by using the super cool, super freeze or super cool and freeze modes.
- For short-term storage of food, you can set the temperatures to between 2°C and 4°C (fridge) and -24°C and -21°C.
- For long-term storage of food, you can set the temperatures to between 5°C and 8°C (fridge) and -20°C and -16°C.
- **Note: The temperature of the freshly stored food and how often the door is opened affects the temperature in the refrigerator compartment. If required, change the temperature setting.**
- When you first switch on the appliance, to enable suitable cooling, the appliance should work 24 hours continuously until it cools down to sufficient temperature.
- During this time do not open the door frequently or place a lot of food inside the appliance.
- If the unit is switched off or unplugged, you must allow at least 5 minutes before restarting or re-plugging the unit in order not to damage the compressor.
- Your appliance is designed to operate in the ambient temperature intervals stated in the associated standards, according to the climate class stated on the information label. We do not recommend operating your fridge out of the stated temperatures, as the appliance may not operate to its optimum level
- The ambient temperature range for this appliance is 10°C to 43°C.



Russell Hobbs

For Customer Services & Spare Parts please call **0345 208 8750**
Opening times: Monday - Friday 8am – 8pm & Saturday 9am – 1pm
or visit us at www.produccare.co.uk

Usage Information

Shelving and rack adjustment

Important note: all food and drink should be removed from all shelves and racks before adjusting or removing them

You can adjust the shelving in the fridge compartment to your required configuration. To remove a shelf, lift it up slightly so the plastic stabilisers that on either side of the shelf are above the shelf rails and then pull it towards you.

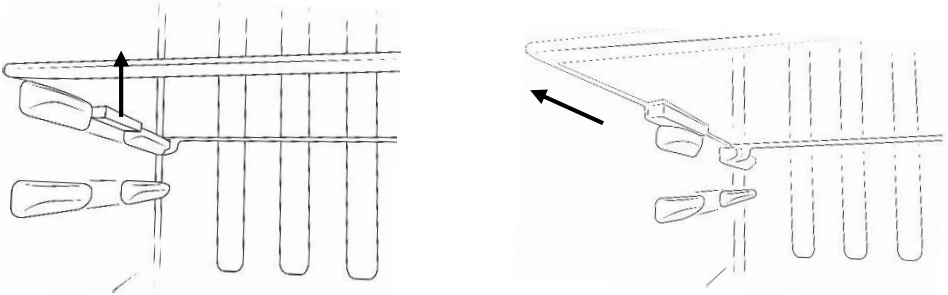

You can adjust the racks in the fridge and freezer compartments to your required configuration. To remove a rack hold both sides of the rack, lift it upwards (1) and then pull it towards you (2).

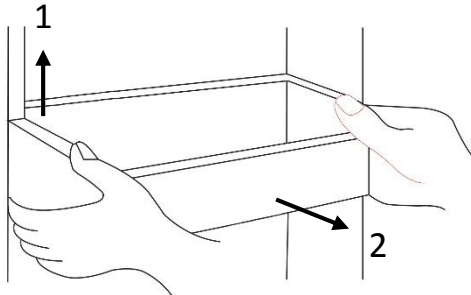

 Russell Hobbs

For Customer Services & Spare Parts please call **0345 208 8750**
Opening times: Monday - Friday 8am – 8pm & Saturday 9am – 1pm
or visit us at www.productcare.co.uk

Cleaning and Maintenance

- Disconnect the appliance from the power supply before cleaning.
- Do not pour water directly over or on the appliance.
- The refrigerator compartment should be cleaned periodically using a solution of bicarbonate of soda and lukewarm water.
- Do not use abrasive products, detergents or soaps. After cleaning wipe down with a damp clean cloth.
- **Note:** Reconnect to the power after you have dried your hands.

Defrosting your freezer

- The appliance is frost free, so there shouldn't be any requirement to defrost the freezer. However, in the unlikely event the appliance does need defrosting please follow the below steps:
 - Try to use as much as possible of the food in the freezer, before defrosting. However, any food that is left, wrap in newspaper and place aside until ready to place back after cleaning.
 - Switch the appliance off at the wall socket and remove the plug.
 - Open the freezer door.
 - Place a suitable container to collect the water created from the defrosted ice.
 - After defrosting, clean and dry the interior.
 - Switch the appliance on and replace any frozen food.

Defrosting can be accelerated by putting bowls of hot (not boiling) water in the freezer and loosening the frost with a suitable plastic scraper.

Do not use sharp metal tools as it may damage the appliance.

Do not use an electrical heater, this may cause an electric shock.



For Customer Services & Spare Parts please call **0345 208 8750**
Opening times: Monday - Friday 8am – 8pm & Saturday 9am – 1pm
or visit us at www.productcare.co.uk

Bulb Replacement

The fridge and freezer lights are energy efficient, long life LEDs. Therefore, they should not need replacing throughout the life of the product.

Reversing the Door

The doors cannot be reversed



Russell Hobbs

For Customer Services & Spare Parts please call **0345 208 8750**
Opening times: Monday - Friday 8am – 8pm & Saturday 9am – 1pm
or visit us at **www.productcare.co.uk**

Troubleshooting

Problem	Solution
The fridge/freezer doesn't work	Check that the appliance is switched on.
	Check that there has not been a power cut.
	Check that the plug is not faulty.
	Check that the fuse has not blown.
The temperature inside the appliance is not cold enough	Check that the voltage is correct for the appliance.
	Check that there is not too much food in the appliance.
	Check that the thermostat is set to a suitable temperature.
	Check that the appliance is not placed in direct sunlight, or too near to a heating source.
	Check that the ambient temperature is within the operation limits of the appliance.
The temperature within the appliance is too cold.	Opening the doors frequently will also reduce the temperature within the fridge.
	Increase the working temperature by adjusting the thermostat to a lower setting.
The inner surfaces of the appliance are wet	Caused by condensation - dry the inside of the appliance.
The outer surfaces of the appliance are wet	Caused by condensation - dry the outer of the appliance carefully.
Excess ice or frost has built up inside the appliance	Check that the door has not been left open.
	Check that the door gasket is clean and undamaged.
Unusual noises	Check that the appliance is on a flat, level surface and is stable.
	Check the spacing's around the appliance and ensure it is not touching other items.



Russell Hobbs

For Customer Services & Spare Parts please call **0345 208 8750**
 Opening times: Monday - Friday 8am – 8pm & Saturday 9am – 1pm
 or visit us at www.productcare.co.uk

Troubleshooting

Problem	Solution
Smell/odour	<p>Check all the food and drink that is in the fridge is in date and correctly packaged. If it isn't then it should be removed immediately or repackaged.</p> <p>Check for spillages on each shelf, rack and drawer. You may need to remove the drawers to check that no spillages have settle underneath them. As spillages that have not been cleaned and have been left can cause smells and unwanted odours.</p>



Russell Hobbs

For Customer Services & Spare Parts please call **0345 208 8750**
Opening times: Monday - Friday 8am – 8pm & Saturday 9am – 1pm
or visit us at www.productcare.co.uk

Important Notes:

The cooling gas which circulates in the refrigerator circuit may make a slight noise (bubbling sound) even when the compressor is not running. This is quite normal. If these sounds are different check that ;

- The appliance is level.
- Nothing is touching the rear of the appliance.

If the problem persists after you have followed all the instructions above, please consult Product Care on 0345 208 8750.

- The compressor protection function will be activated after sudden power breakdowns or after unplugging the appliance, because the gas in the cooling system will not have stabilised sufficiently. Your fridge will start after a short period of time, this is quite normal.
- If you do not use your appliance for a long period of time (e.g. when on summer holidays) unplug it. Clean and leave the door open to prevent humidity and bad odours.

Product Specification

- Energy efficiency performance rating: A+
- Star freezer rating: 4
- Net fridge capacity: 345 litres/12.18 cubic feet
- Net freezer capacity: 192 litres/6.78 cubic feet
- Noise level: 43dB
- Fridge: 4 door racks, 1 dairy compartment, 1 egg tray, 4 glass shelves, wine rack, 2 drawers
- Freezer: 5 door racks, 3 shelves, 2 drawers, ice cube drawer
- Dimensions (CMs): (H)176.0 x (W)90.2 x (D)75.0

Climate Class Ambient Temperature (°C)

SN Between 10 and 32 (°C)

N Between 16 and 32 (°C)

ST Between 16 and 38 (°C)

T Between 18 and 43 (°C)



Russell Hobbs

For Customer Services & Spare Parts please call **0345 208 8750**
Opening times: Monday - Friday 8am – 8pm & Saturday 9am – 1pm
or visit us at www.productcare.co.uk

Connection to the mains supply

For UK use only – Plug fitting details (where applicable):

As the colours of the wires in the mains lead of this appliance may not correspond with the coloured markings identifying the terminals in your plug, proceed as follows:

The GREEN/YELLOW wire is the EARTH and must be connected to the terminal which is marked with the letter E or by the earth symbol or coloured GREEN or GREEN/YELLOW.

The BLUE wire is the NEUTRAL and must be connected to the terminal marked with the letter N or coloured BLACK. The BROWN wire is the LIVE wire and must be connected to the terminal marked with the letter L or coloured RED.

Always ensure that the plug cord grip is fastened correctly.

If a 13A (BS1363) fused plug is used it must be fitted with a 13amp fuse conforming to BS1362 and be BSI or ASTA approved.



DANGER
Electric
Shock Risk

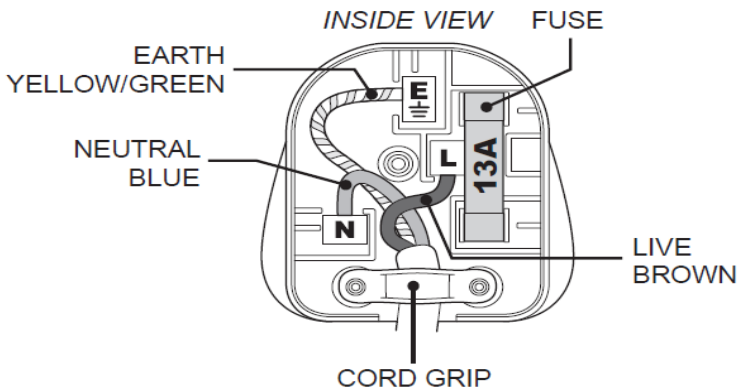

 Russell Hobbs

For Customer Services & Spare Parts please call **0345 208 8750**
Opening times: Monday - Friday 8am – 8pm & Saturday 9am – 1pm
or visit us at www.productcare.co.uk

Guarantee

This product is guaranteed for 12 months from the date of the original purchase. If any defect arises due to faulty materials or workmanship the faulty product must be returned to the place of purchase.

Refund or replacement is at the discretion of the retailer.

The following conditions apply:

- The product must be returned to the retailer with the original proof of purchase.
- The product must be installed and used in accordance with the instructions contained in this instruction guide and any other instructions for use which have been supplied.
- It must be used for domestic purposes only and for its intended use.
- This warranty does not cover wear and tear, damage, misuse or consumable parts.

This does not affect your statutory rights.

Produced for:

G2S Limited

Wigan

WN2 4AY



Russell Hobbs

For Customer Services & Spare Parts please call **0345 208 8750**
Opening times: Monday - Friday 8am – 8pm & Saturday 9am – 1pm
or visit us at www.productcare.co.uk

Notes:



Russell Hobbs

For Customer Services & Spare Parts please call **0345 208 8750**
Opening times: Monday - Friday 8am – 8pm & Saturday 9am – 1pm
or visit us at www.productcare.co.uk

Notes:



Russell Hobbs

For Customer Services & Spare Parts please call **0345 208 8750**
Opening times: Monday - Friday 8am – 8pm & Saturday 9am – 1pm
or visit us at **www.productcare.co.uk**

For Customer Services &
Spare Parts please call

0345 208 8750

Opening times:
Monday – Friday

8am – 8pm

&

Saturday

9am – 1pm

or visit us at

www.productcare.co.uk



This symbol is known as the 'Crossed-out wheelee bin Symbol'. When this symbol is marked on a product/batteries, it means that the product/batteries should not be disposed of with your general household waste. Only discard electrical/electronic/battery items in separate collection schemes, which cater for the recovery and recycling of materials contained within. Your co-operation is vital to make sure the success of these schemes and for the protection of the environment. For your nearest disposal facility, visit www.recycle-more.co.uk or ask in store for details.

We reserve the right due to possible changes to design to alter the instruction manual without prior notice.

 Russell Hobbs

Revision 2