



# SONIC™

THE HEDGEHOG

76995





LEGO® Builder



[LEGO.com/sustainable-packaging](https://LEGO.com/sustainable-packaging)



 <sup>FR</sup> **DONNEZ**  
OU  
**RECYCLEZ**

 OU  OU 

ASSOCIATION    MAGASIN    DÉCHÈTERIE

Adresses sur [quefairedemesdechets.fr](https://quefairedemesdechets.fr)

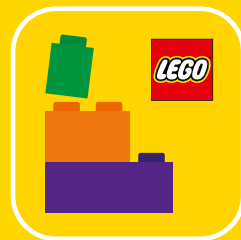

# BUILDER



Apple and the Apple logo are trademarks of Apple Inc., registered in the U.S. and other countries and regions. App Store is a service mark of Apple Inc. Google Play and the Google Play logo are trademarks of Google LLC. Tencent and the Tencent logo are trademarks of Tencent Inc.

[LEGO.com/devicecheck](https://www.lego.com/devicecheck)

**EN** Ask parents' permission before going online | **DE** Eltern um Erlaubnis bitten, bevor du online gehst | **FR** Demande l'autorisation d'un parent avant d'aller en ligne | **IT** Chiedi il permesso ai tuoi genitori prima di andare online | **ES** Pídeles permiso a tus papás antes de conectarte a Internet | **PT** Pede autorização aos pais antes de acederes online | **ZH** 上网前应先征得父母的同意 | **PL** Poproś rodziców o zgodę, zanim wejdiesz do Internetu | **CS** Než půjdeš na internet, požádej rodiče o svolení | **SK** Skôr než pôjdeš na internet, vypýtaj si povolenie od rodičov | **HU** Kérj szülői engedélyt, mielőtt online csatlakoznál! | **RO** Cere permisiunea părinților înainte de a te conecta online | **BG** Поискайте разрешение от родител, преди да влезете онлайн | **LV** Pirms došanās tiešsaistē palūdz atļauju vecākiem | **ET** Enne Interneti kasutamist küsi vanematelt luba | **LT** Prieš prisijungdami prie interneto, atsiklauskite tėvų



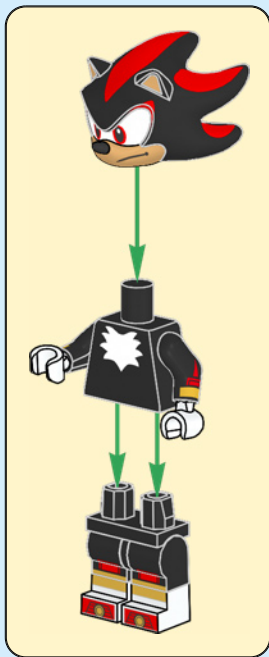

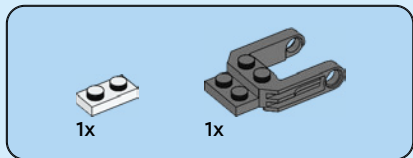
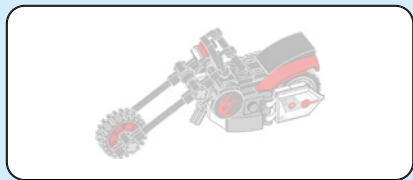

1

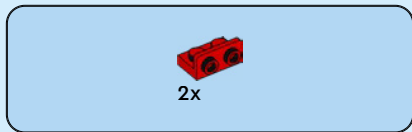
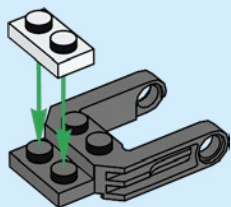

2

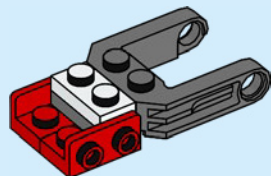



1x



1x

3

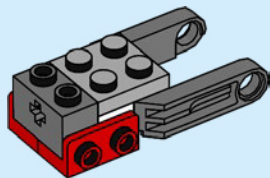

2x

4

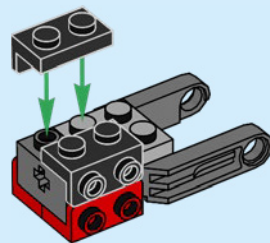

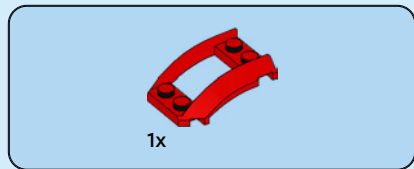

5

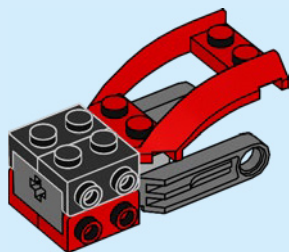

6

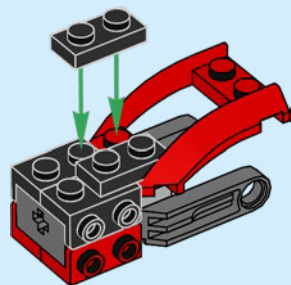





2x



2x

7

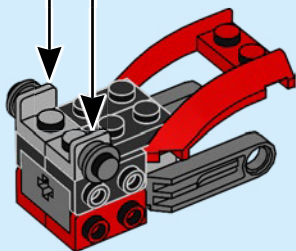
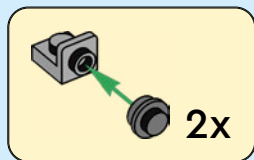

1x



1x

8

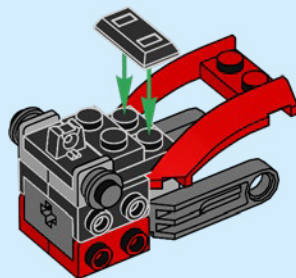



1x

9

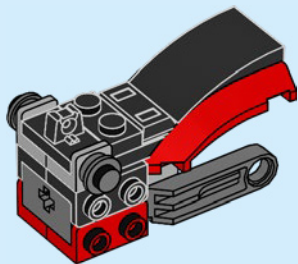

1x



1x

10

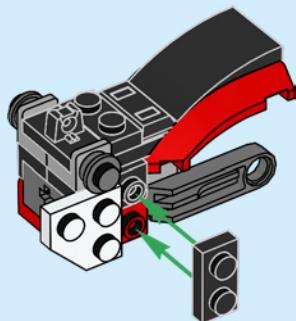



1x

11

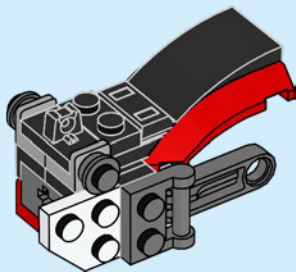

1x



1x

12

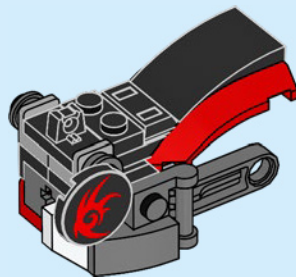



1x

13

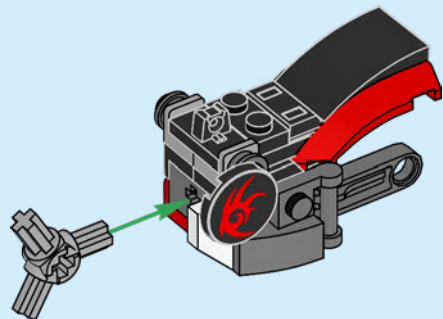

12



1x

14

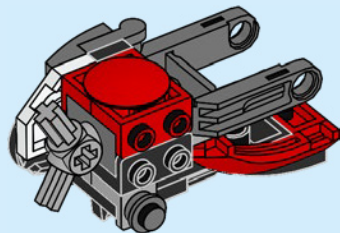
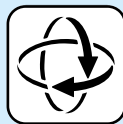



1x



1x

15

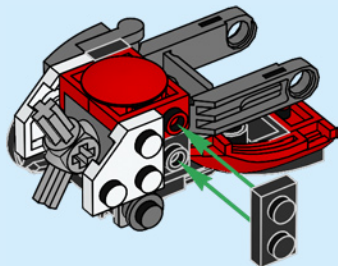

1x

16

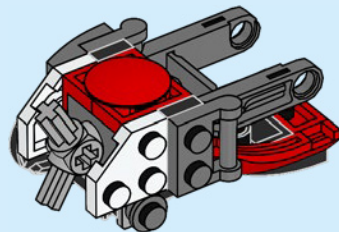



1x



1x

17

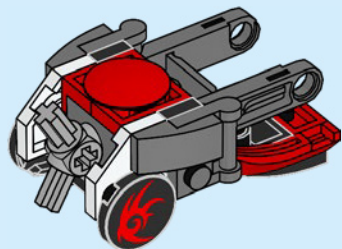

1x

18

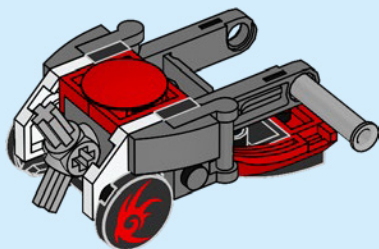

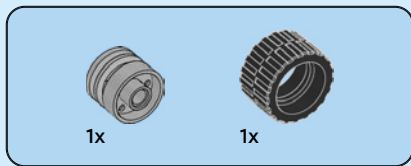

19

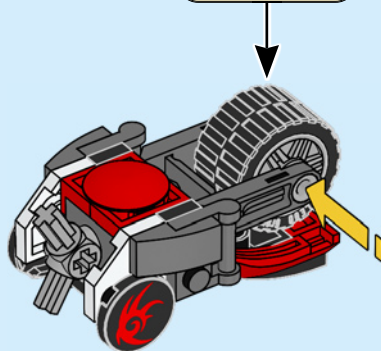
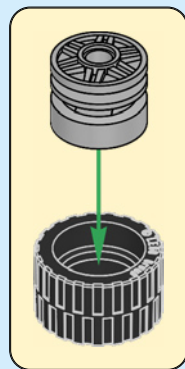



2x



2x



2x

# 20

1

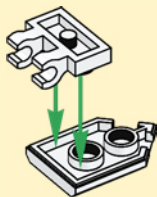

2

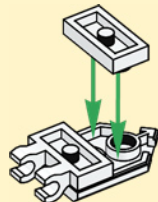

3



2x

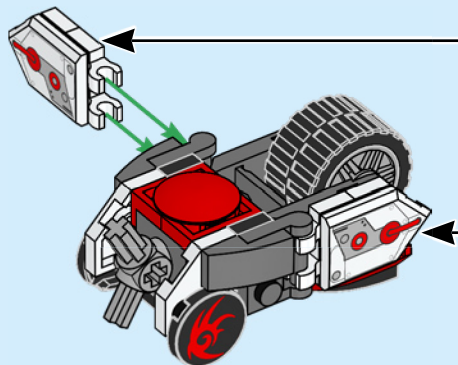





21

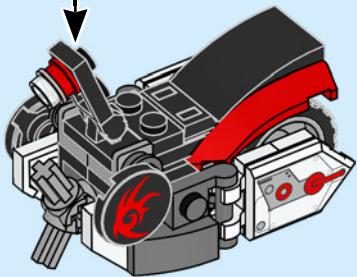
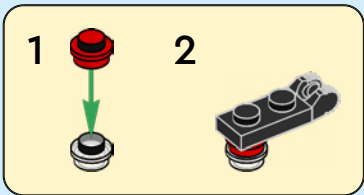

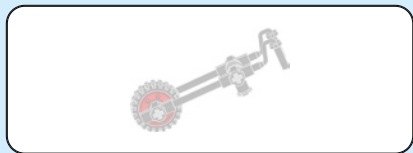

22

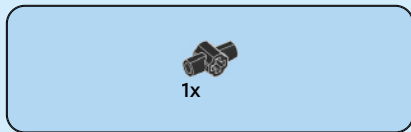
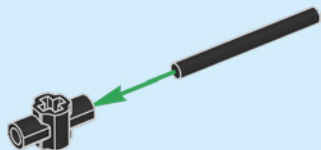

23

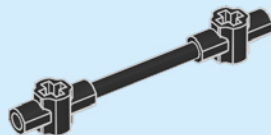

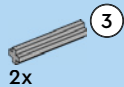

24

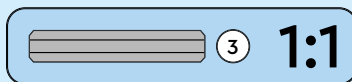
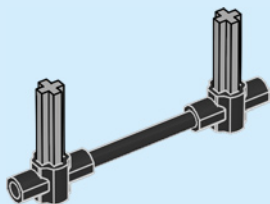

25

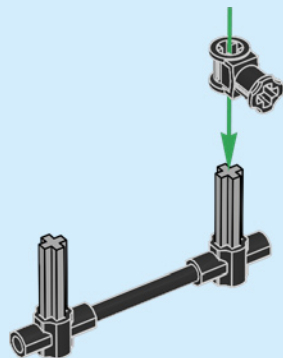

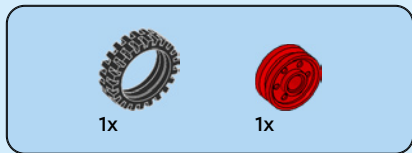

26

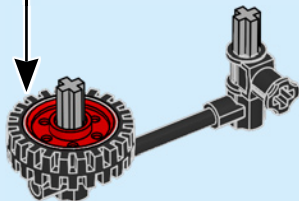
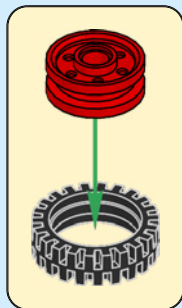



27

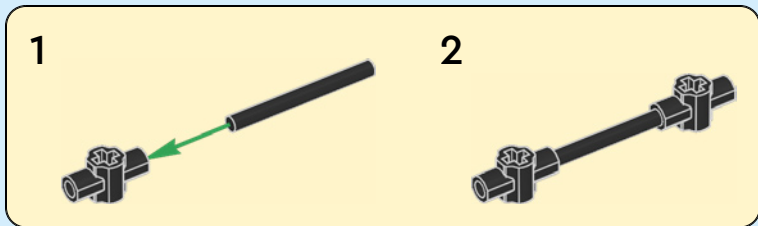

2

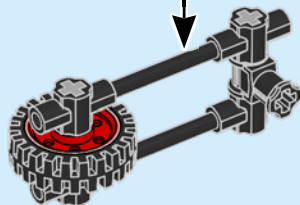
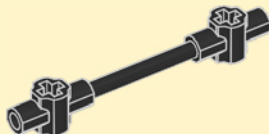



2x

28

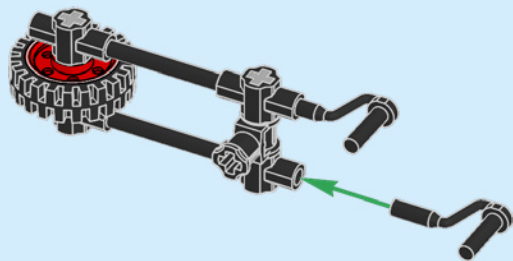

29

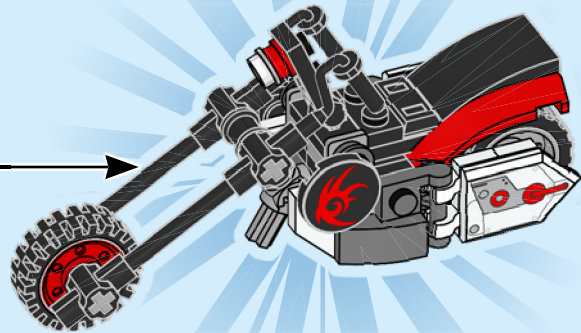

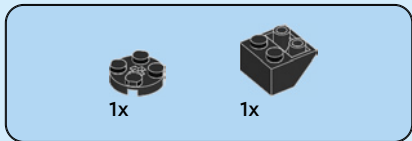
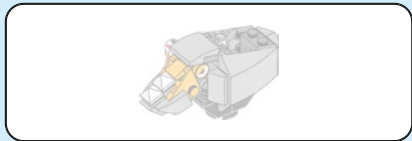

1

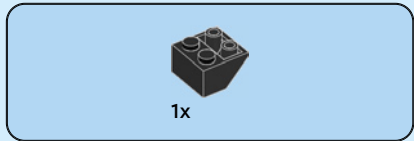
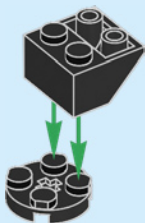

2

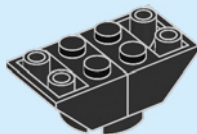







1x

5

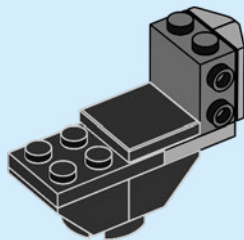

2x



1x



1x



2x

6

1

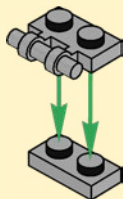

2

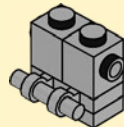

3

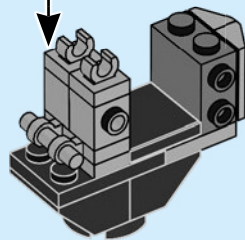
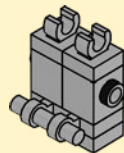

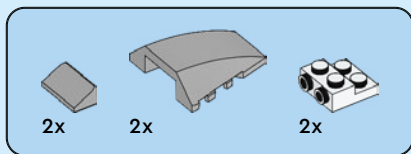

7

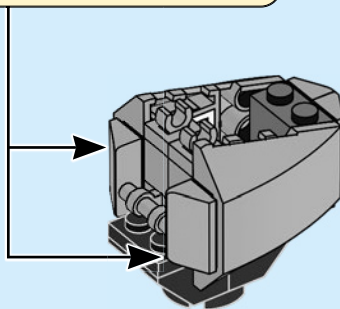
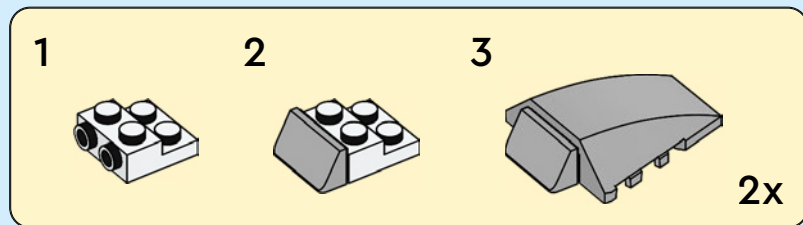



1x



1x

8

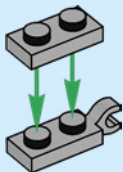

1x

9

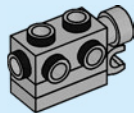

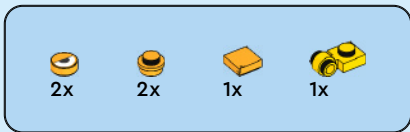

10

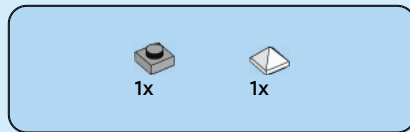
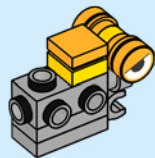
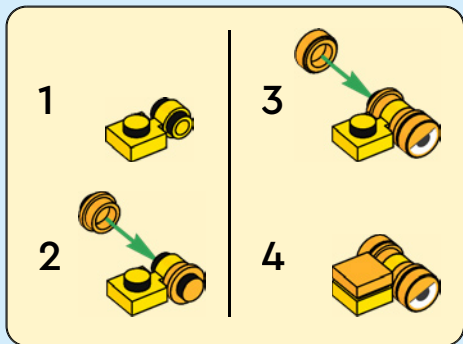

11

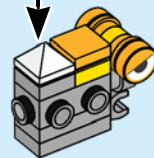
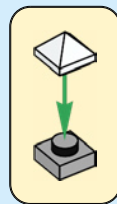

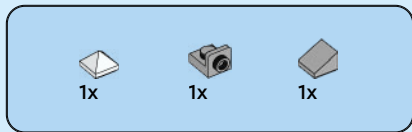

12

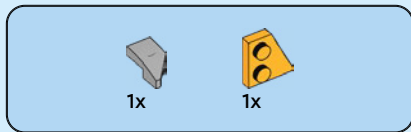
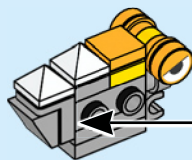
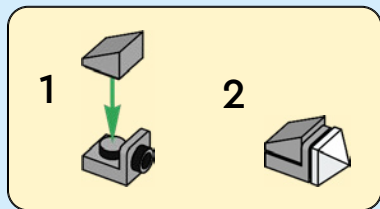

13

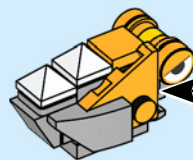
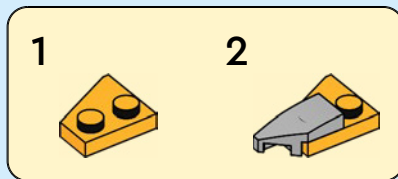

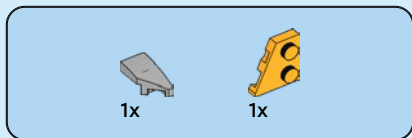

14

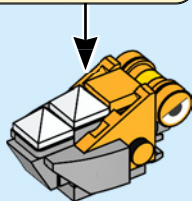
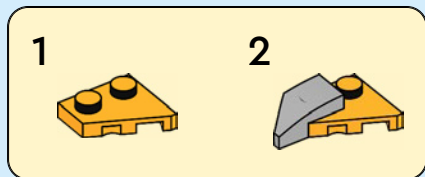

15

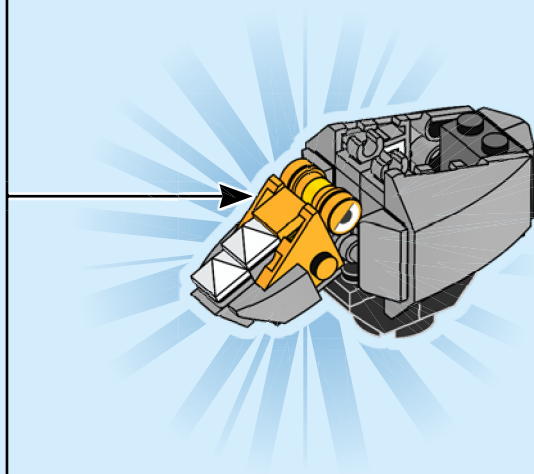

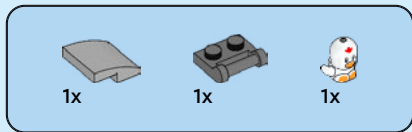

16

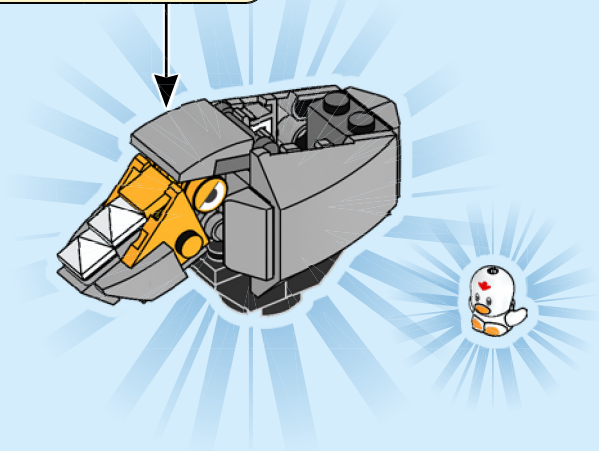
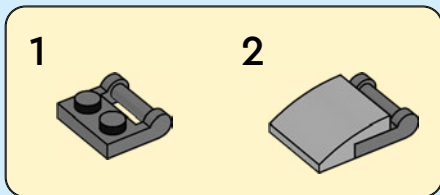





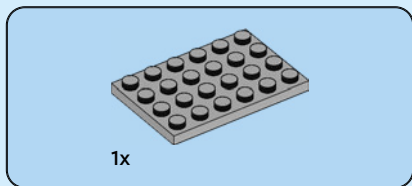
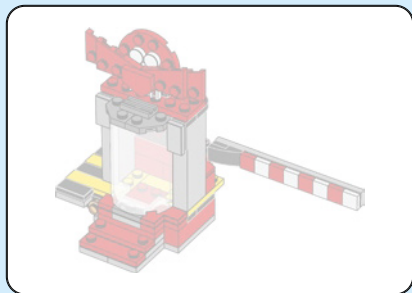

1

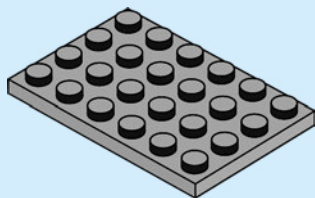

1x



1x

2

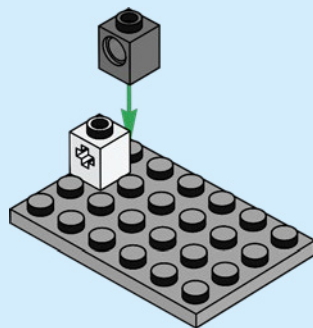



1x

3

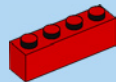
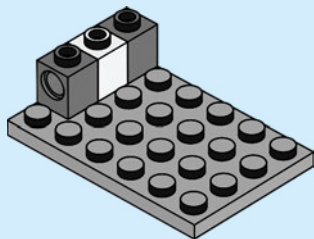

2x

4

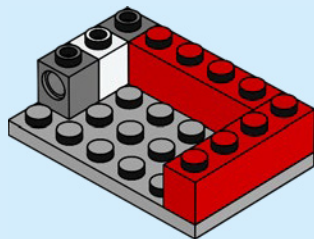

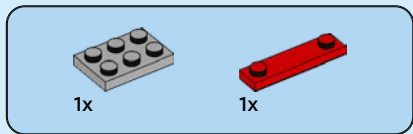
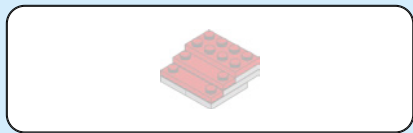

5

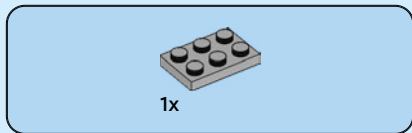
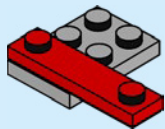

6

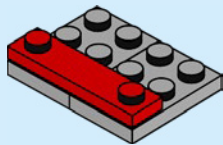

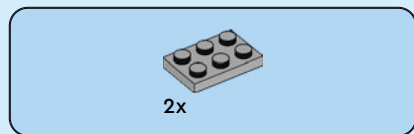

7

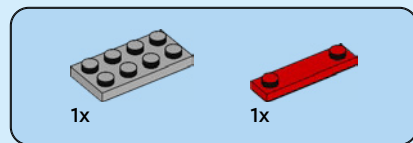
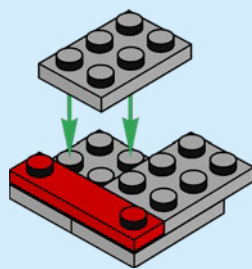

8

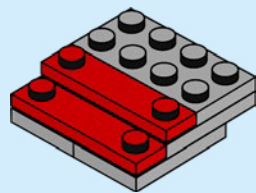

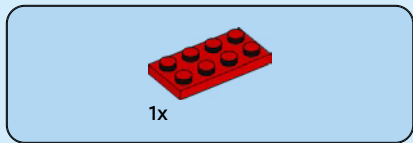

9

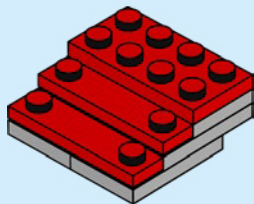

10

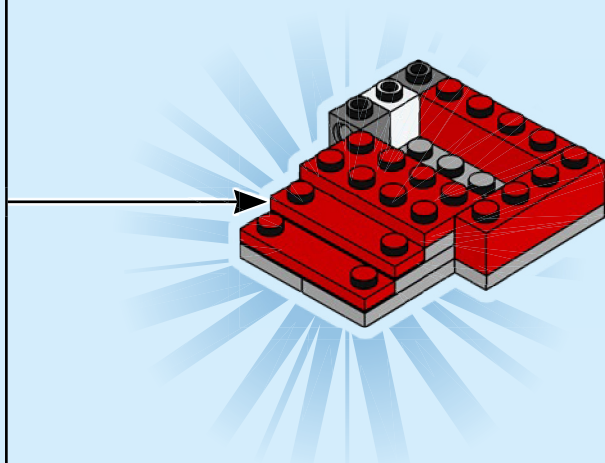

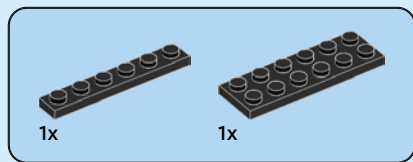

11

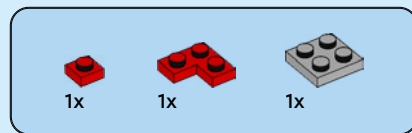
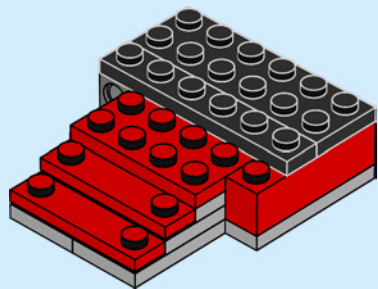

12

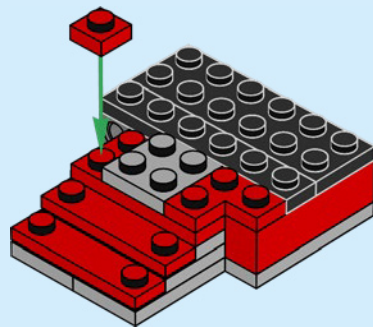

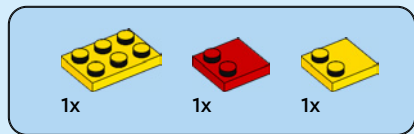

13

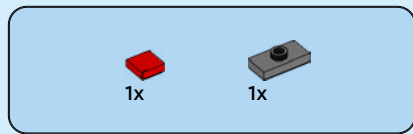
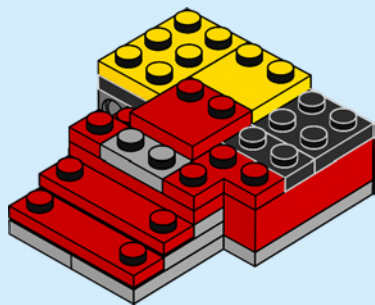

14

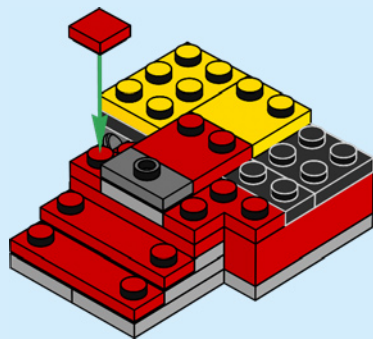



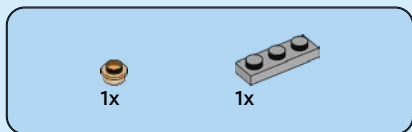
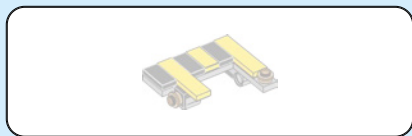

15

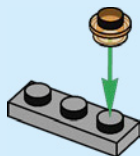

1x

1x

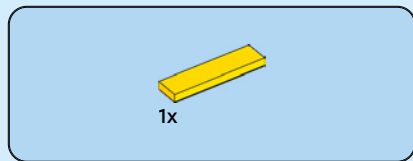

1x

16

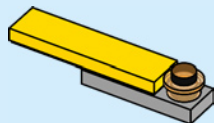

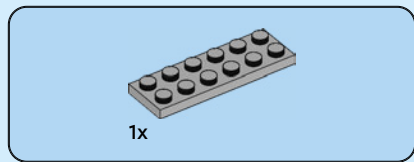

17

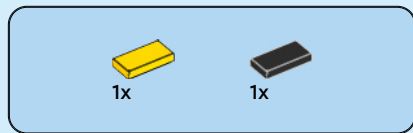
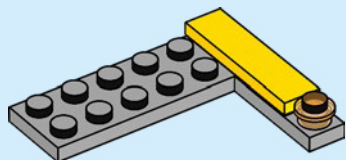

18

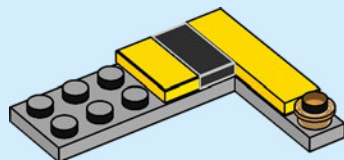

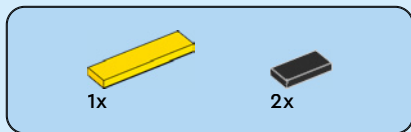

19

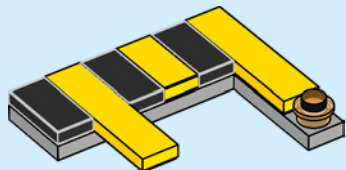

20

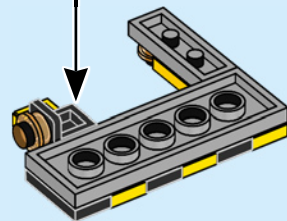
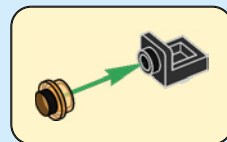



2x



2x

21

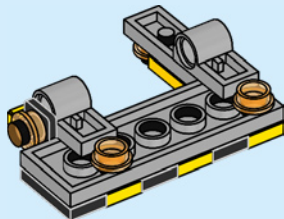

2x

22

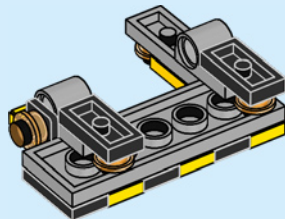

23

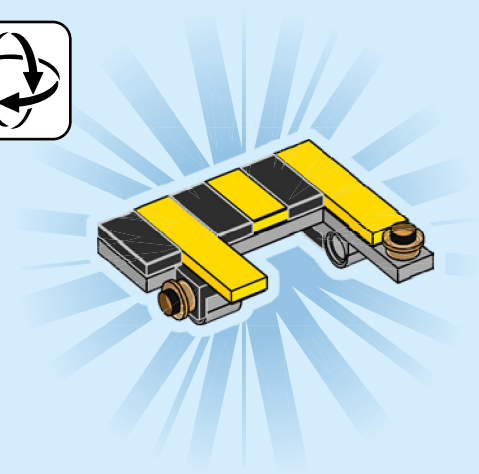

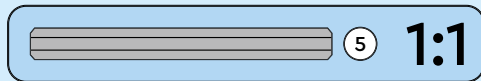
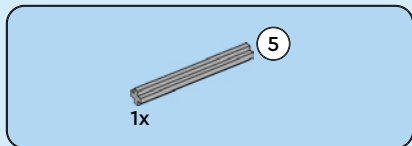

24

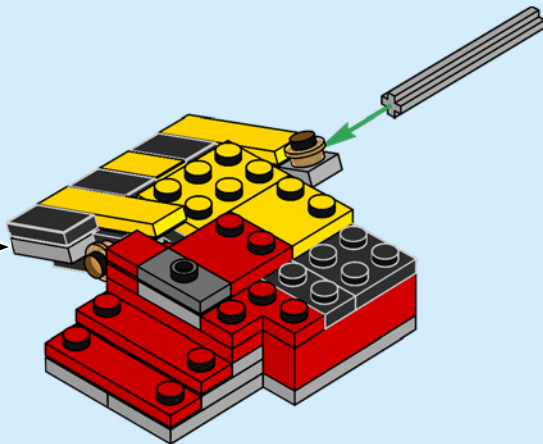



25

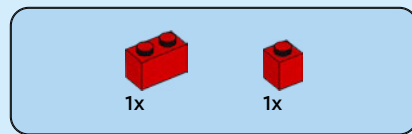
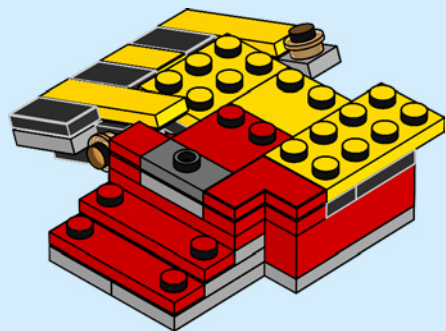

26

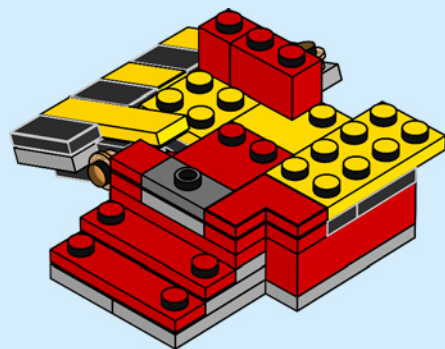



1x



1x

27

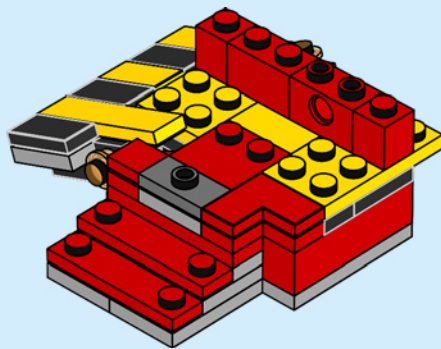



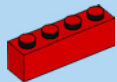

1x



2x

# 28

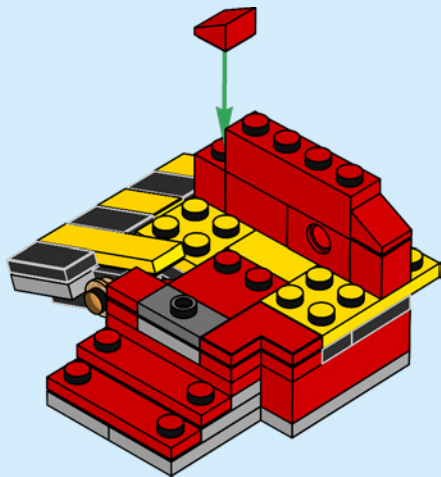



1x

29

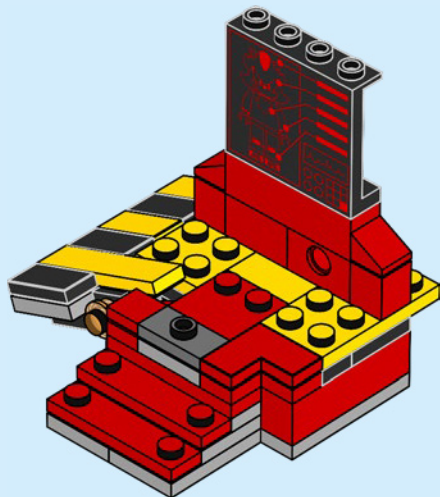

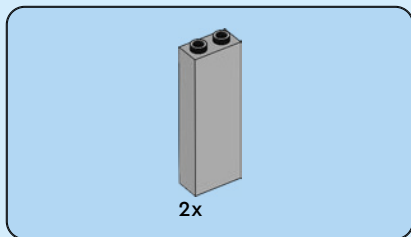

30

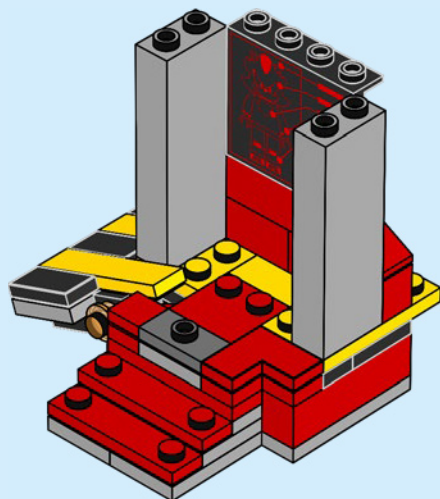



1x



2x

# 31

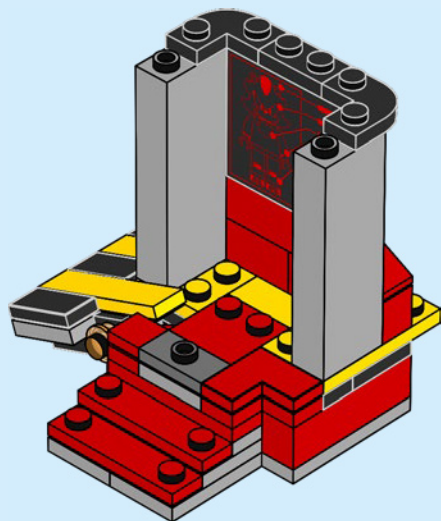

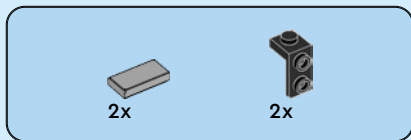

32

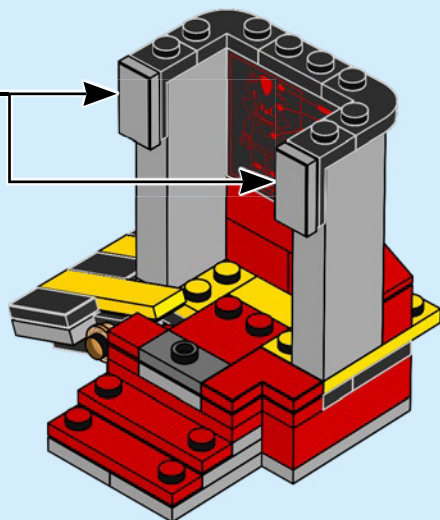
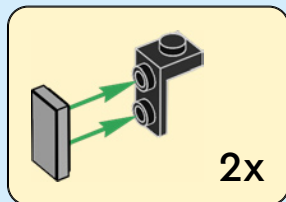

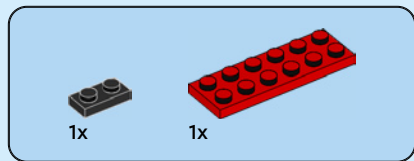

33

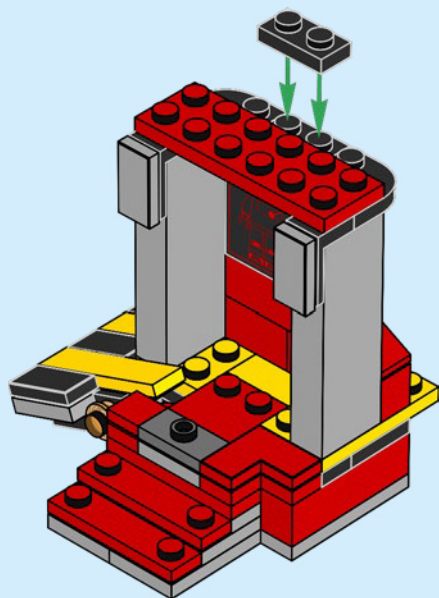



1x



1x

# 34

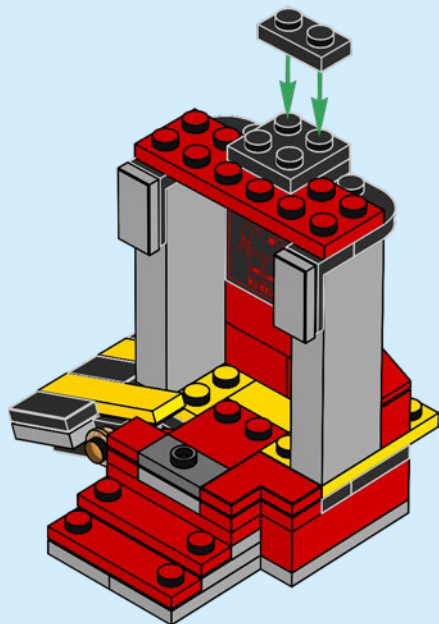



1x



35



2x

36







2x

37



1x



1x

38

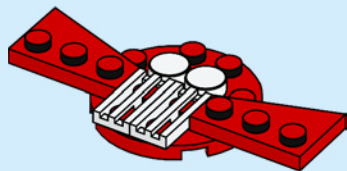



1x



1x

39

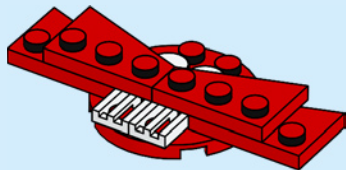

1x

40

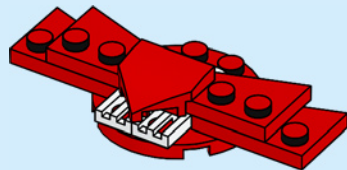



1x

41

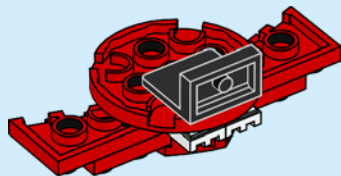

42

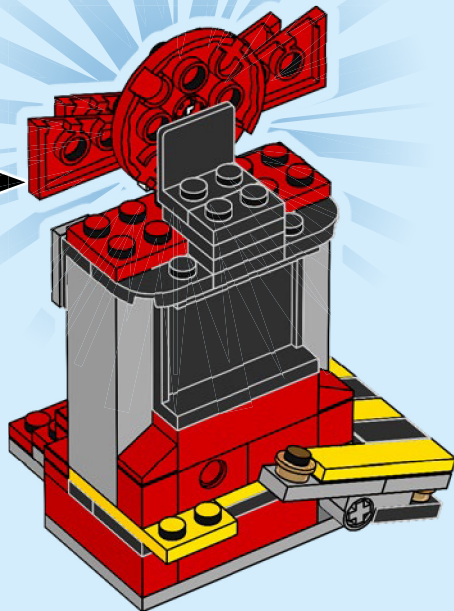



1x

43

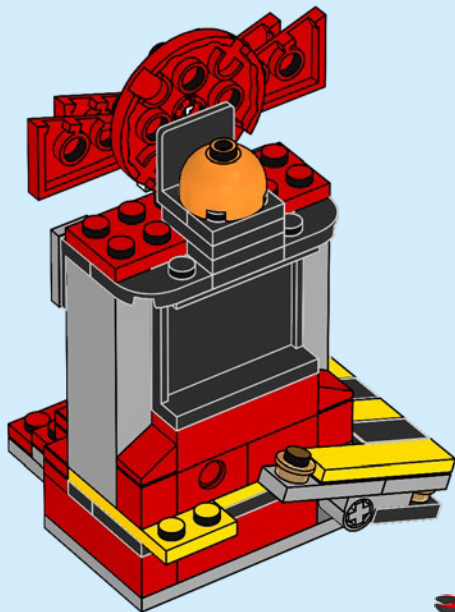

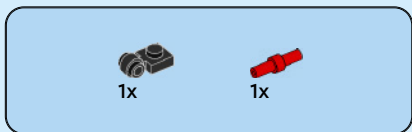
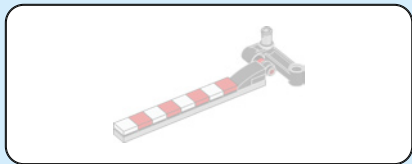

44

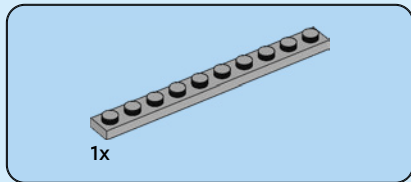
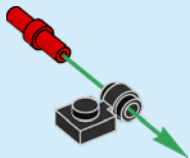

45

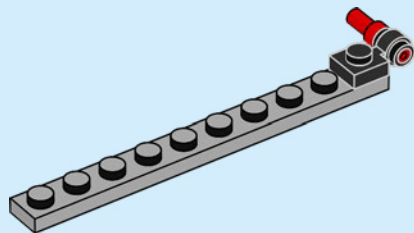



1x

46

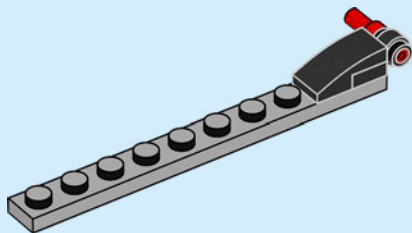

4x



4x

47

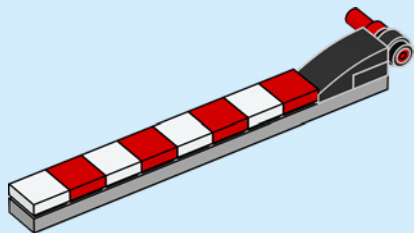

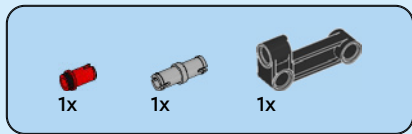

48

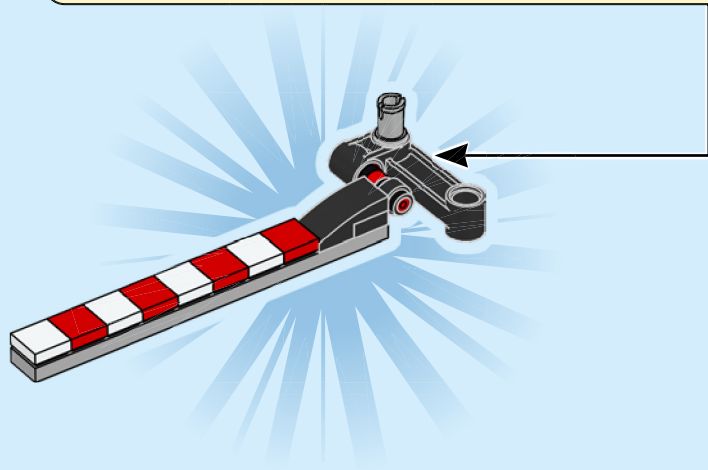
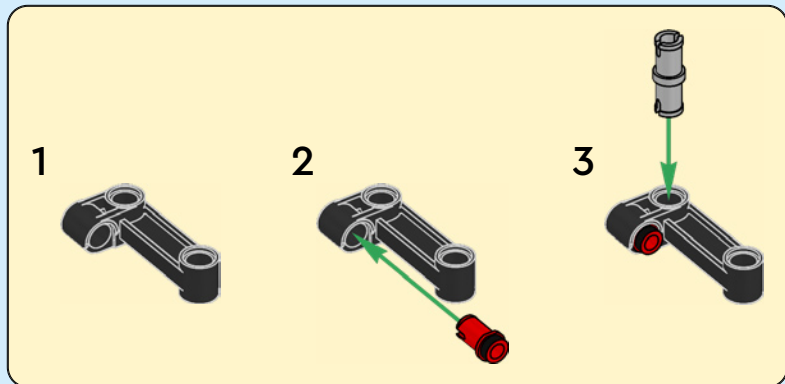



49

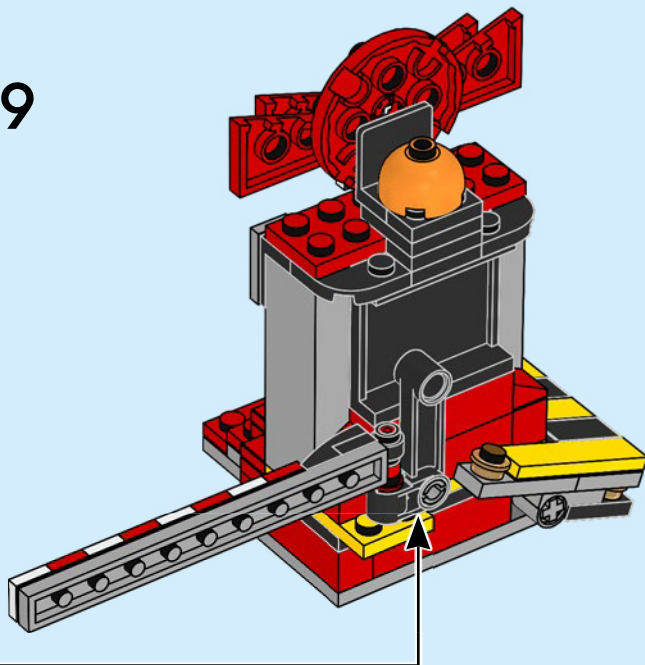

50

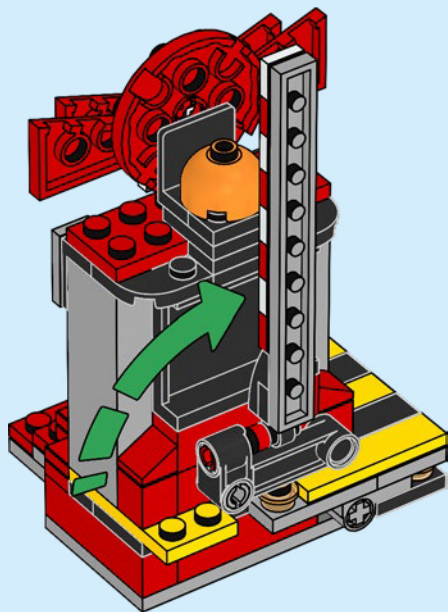

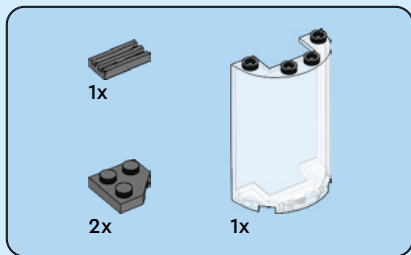

51

1

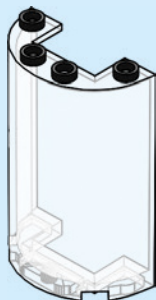

2

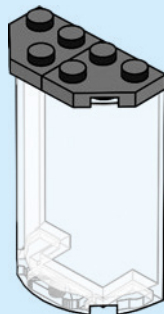

3

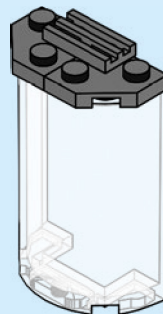

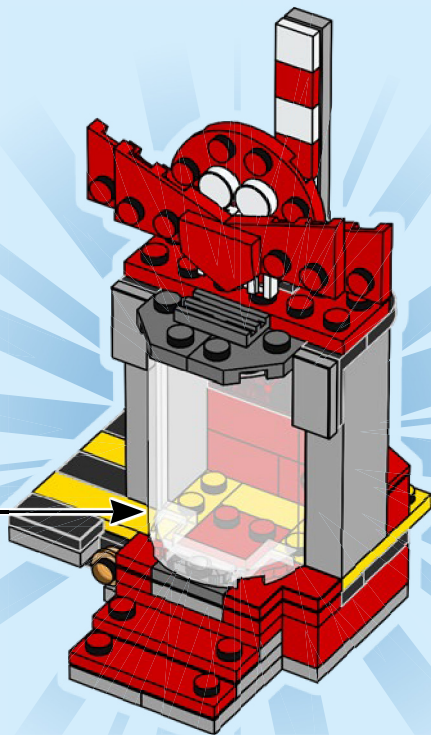

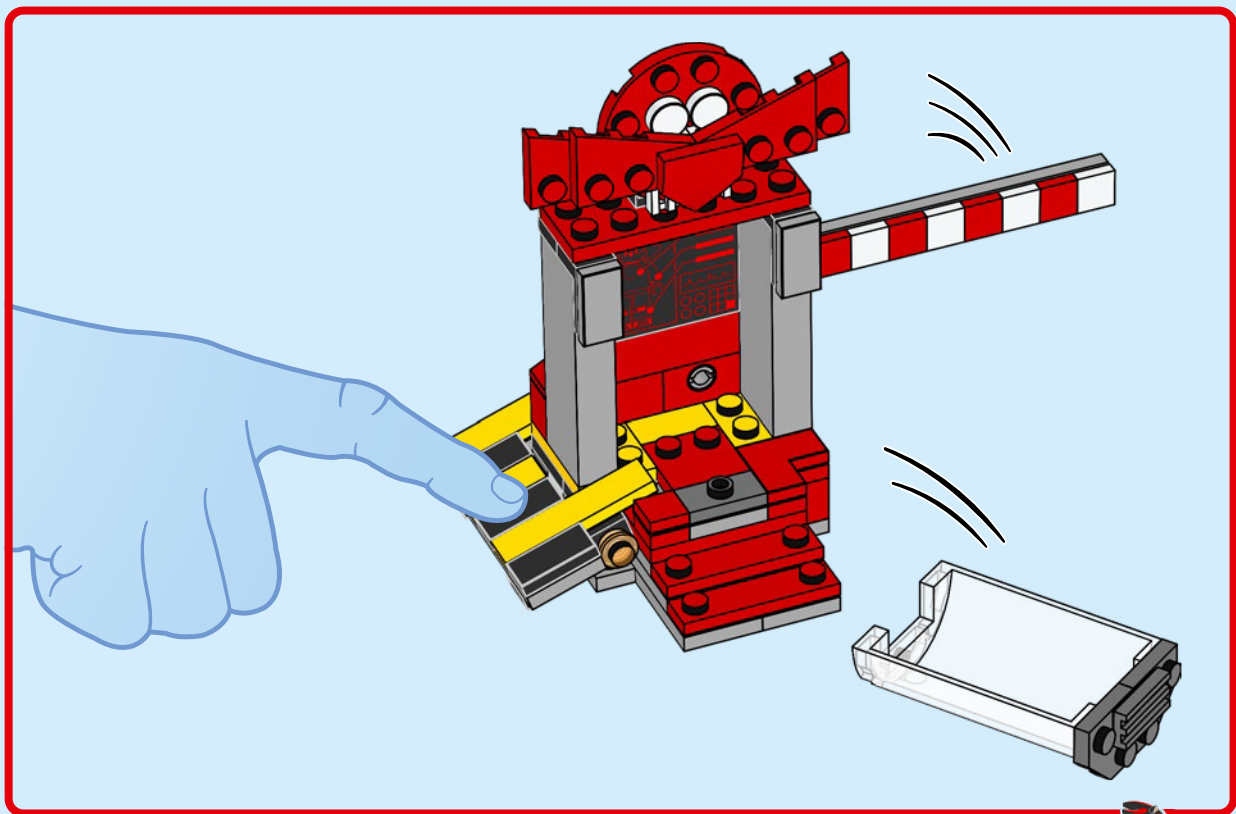

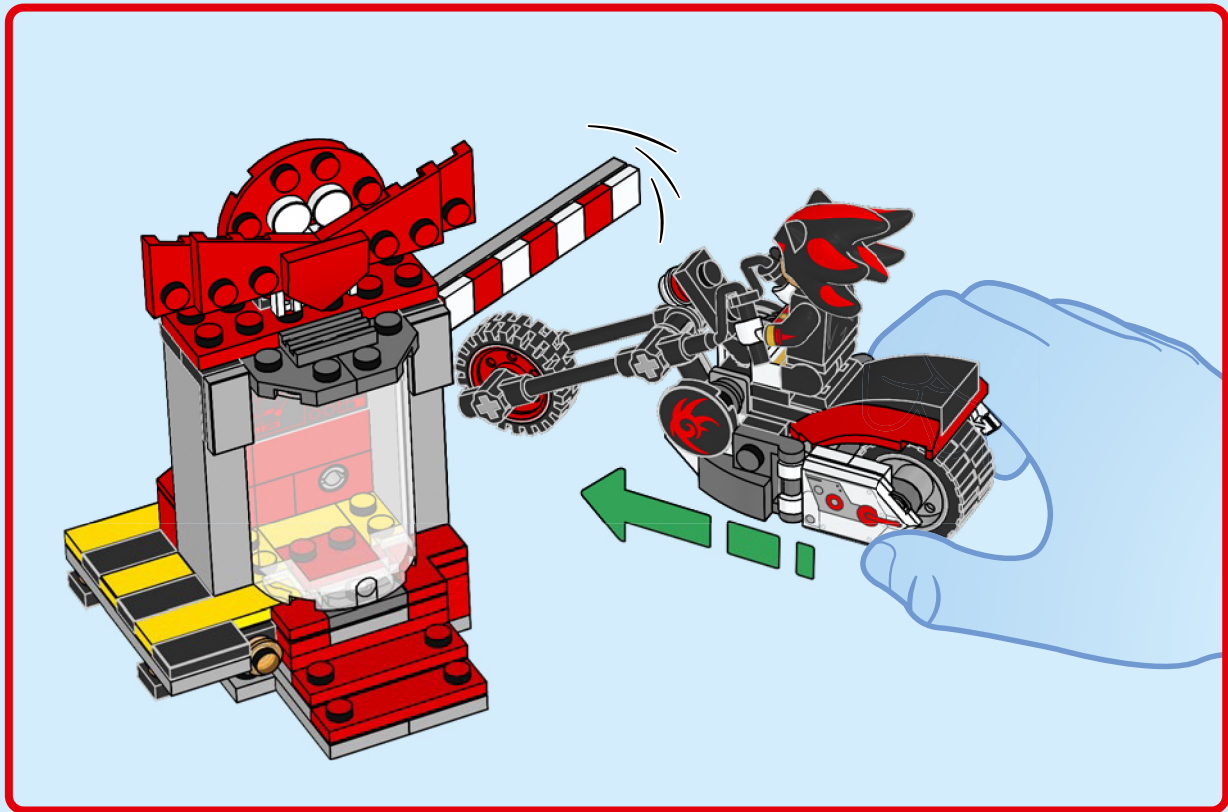

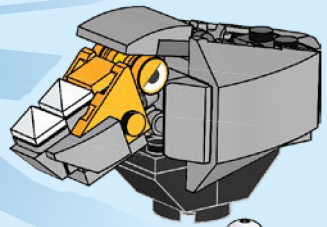
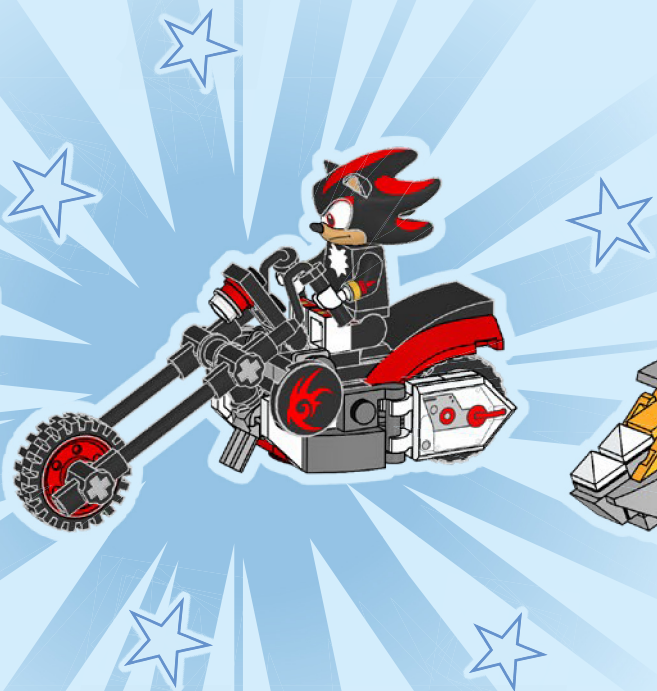
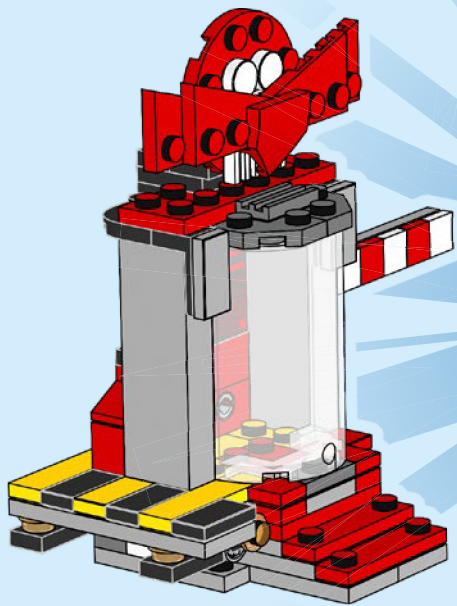



# SONIC™

## THE HEDGEHOG

Explore more  
Mehr entdecken  
En savoir plus  
Esplora di più  
Explora más  
Explorar mais  
了解更多  
Zobacz więcej

Objev více  
Objav viac  
Tudj meg többet!  
Descoperă mai multe  
Разгледайте още  
Izpēti vairāk  
Uuri lähemalt  
Atraskite daugiau

EXPLORE MORE



 [LEGO.com/sonic](https://LEGO.com/sonic)



©SEGA. All rights reserved. SEGA is registered in the U.S. Patent and Trademark Office. SEGA and SONIC THE HEDGEHOG are either registered trademarks or trademarks of SEGA CORPORATION.





76990



76991



76992



76993



76994

2x 6284572	1x 614121	1x 370021	2x 6256923	2x 243124	1x 6474304	1x 302226	1x 6172966
1x 6443188	1x 6378120	1x 300421	1x 4515348	1x 302024	9x 302326	2x 6430580	1x 6474293
2x 6314487	2x 4504379	1x 300421	1x 302021	2x 6380236	1x 6156991	1x 6267045	1x 6474293
1x 6345886	5x 307021	1x 6305047	1x 302021	1x 6299338	3x 306926	1x 4541455	1x 366626
4x 307001	1x 302421	2x 6089698	1x 6133554	1x 6299338	1x 6047276	1x 4541455	1x 379526
3x 302301	1x 6399645	1x 6048859	1x 379521	2x 6192778	2x 6016172	1x 6474420	1x 6472019
2x 6176240	1x 4278275	1x 6219819	1x 6281992	1x 403226	1x 6000650	1x 6132299	1x 6240227
2x 241201	2x 300521	1x 242021	1x 306924	2x 6474295	2x 6425507	2x 6116604	4x 6240030
2x 6347287	2x 4180533	1x 6078641	1x 6224666	1x 6281993	1x 306826	1x 302126	1x 6240030
2x 6469441	2x 4180504	3x 301021	1x 302124	4x 6280097	1x 6265730	1x 6147790	1x 6246876
2x 6474294				1x 6331716			



1x  
6225139



1x  
4211399



2x  
4558953



3x  
6335328



1x  
4521921



1x  
6225142



4x  
4568637



1x  
4211807



2x  
4211398



2x  
4211414



2x  
6168633



1x  
4502595



1x  
4211632



2x  
6308012



1x  
6319336



1x  
6102357



2x  
6335830



2x  
4211363



4x  
4211396



3x  
4211397



1x  
4211395



2x  
4211815



1x  
4211639



1x  
4211452



1x  
4211404



1x  
4251149



1x  
6109684



1x  
6338962



1x  
4211502



1x  
4211429



2x  
6331261



2x  
6474296



1x  
6065504



1x  
6296241



1x  
6328059



2x  
4210633



2x  
4210639



1x  
6178919



2x  
6029948



1x  
6092572



2x  
6164073



1x  
4210631



1x  
6314192



3x  
6146321



1x  
6338470



1x  
6474303



 [LEGO.com/service](https://www.LEGO.com/service)

YOU COULD  
**WIN**



Scan this QR code or go to  
**LEGO.COM/PRODUCTFEEDBACK** and give  
us your short feedback about this LEGO® set  
for a chance to win a cool LEGO prize.

Terms and Conditions apply\*



**EN: YOU COULD WIN.** Terms and Conditions apply\* **DE: Du könntest GEWINNEN.** Es gelten die Teilnahmebedingungen\* **FR: Tu pourrais GAGNER.** Des conditions s'appliquent\* **IT: Potresti VINCERE tu.** Termini e condizioni sono applicabili\* **ES: Puedes GANAR.** Aplican términos y condiciones\* **PT: Poderá GANHAR.** Aplicam-se termos e condições\* **ZH: 轻松获奖. 条款和条件适用\*** **PL: Szansa na WYGRANĄ.** Obowiązują warunki korzystania\* **CS: Máte šanci VYHRÁT.** Platí všeobecné smluvní podmínky\* **SK: Máte šancu VYHRAŤ.** Platia všeobecné zmluvné podmienky\* **HU: TE IS NYERHETSZ.** Felhasználási feltételek érvényesek\* **RO: Ai putea CÂȘTIGA.** Se aplică termeni și condiții\* **BG: Можете да СПЕЧЕЛИТЕ.** Има определени правила и условия\* **LV: Tu vari LAIMĒT.** Ir spēkā noteikumi un nosacījumi.\* **ET: Sul on võimalus VÕITA.** Kehtivad tingimused\* **LT: Jūs galite LAIMĖTI.** Taikomos sąlygos\*

\*[LEGO.com/productfeedback/terms](https://www.lego.com/productfeedback/terms)

LEGO and the LEGO logo are trademarks of the LEGO Group. ©2024 The LEGO Group.

©SEGA. All rights reserved. SEGA is registered in the U.S. Patent and Trademark Office.

SEGA and SONIC THE HEDGEHOG are either registered trademarks or trademarks of SEGA CORPORATION.

6494373