

Nomad

 habitat

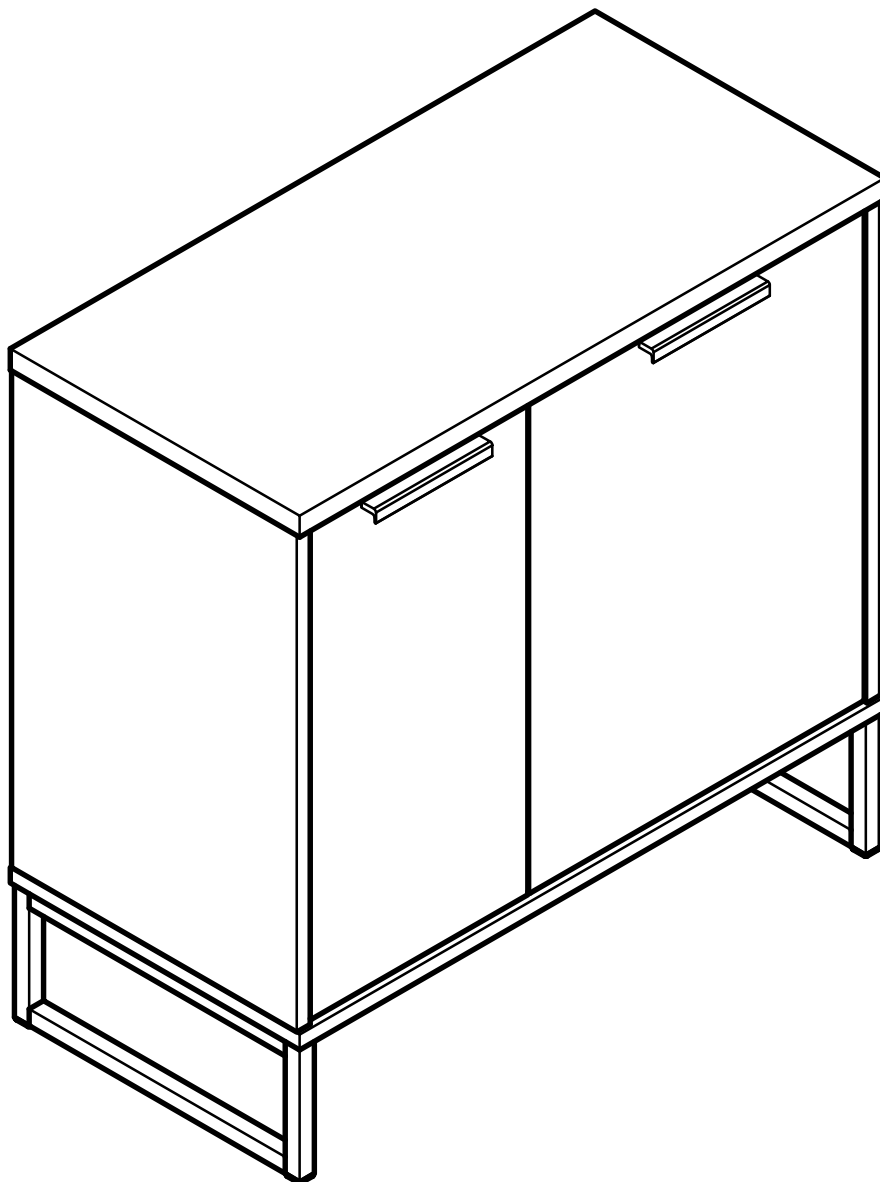

Spare Parts

-  www.argos-support.co.uk
-  Help@ClickSpares.co.uk
-  0370 112 1928

Customer Support

 0345 640 2020



Safety and Care Advice

Product Details

Drinks Cabinet Oak 3930579

Drinks Cabinet Anthracite 3365625

IMPORTANT, RETAIN FOR FUTURE REFERENCE: READ CAREFULLY.

- Keep children and animals away from the work area, small parts could choke if swallowed.
- Make sure you have enough space to layout the parts before starting.
- This product has been constructed to be used in the domestic environment only and not for commercial purposes.

- Assemble the item as close to its final position (in the same room) as possible.
- Assemble on a soft level surface to avoid damaging the unit or your floor.

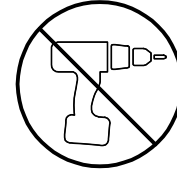

- We do not recommend the use of power drill/drivers for inserting screws as this could damage the unit. Only use hand screwdrivers.
- Parts of the assembly will be easier with 2 people.
- Dispose of all packaging carefully and responsibly.

Care and maintenance

- Only clean using a damp cloth and mild detergent. Do not use abrasive cleaners.
- Use a dry cloth to clean the product, furniture polish is not recommended.
- From time to time check that there are no loose screws, nuts or bolts. If there are please re-tighten.
- This product should not be discarded with household waste. Take to your local authority waste disposal centre.

WARNING

In order to prevent overturning this product must be used with the wall attachment device provided.

Additional Guidance

- Assemble all parts and bolts loosely during assembly, only once the product is complete should you fully tighten the bolts.
- Regularly check and ensure that all bolts and fittings are tightened properly.
- This product is compliant BS4875-7 level 2, EN 14749

Fittings (Shown to scale)

Bag 1

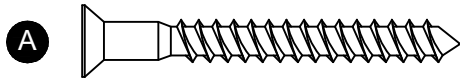

A
5 x 50mm Screw x 10
SCR05050

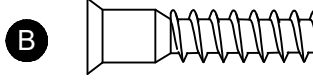

B
7 x 30mm Screw x 6
SCR07030

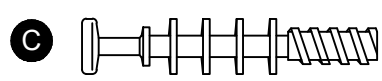

C
7 x 39mm Locking Pin x 22
SCR07039

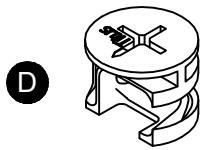

D
15 x 12mm Locking Nut x 22
FIT1512000

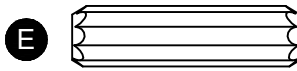

E
8 x 30mm Dowel x 8
PGW0830

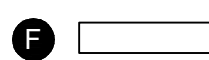

F
4 x 18mm Shelf Support x 4
PGM0418

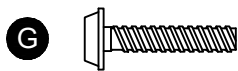

G
4 x 20mm Screw x 4
SCR040209



H
4 x 15mm Screw x 16
SCR04015M (With extra few pieces for spare)

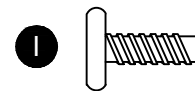

I
6x15mm Screw x 2
SCR06015-L



J
4 x 14.5mm Screw x 2
SCR04014

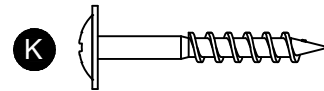

K
4 x 33mm Screw x 2
SCR04033

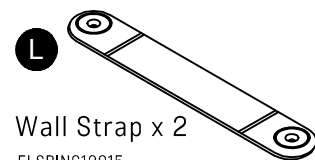

L
Wall Strap x 2
ELSRING10015



M
Wall Plug x 2
CAP070350



N
Allen Key x 1
PAR250704-L



O
7 x 1.5mm Door Pad x 2
PAD0701502

Hardware

P

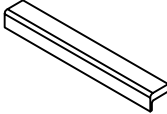

160 x 20mm Handle x 2
HUM16160207

Q

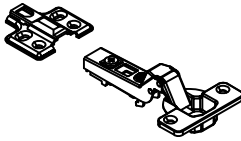

Door Hinge x 4
HIG0900048354F

R

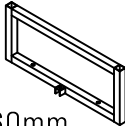

392 x 160mm
Side post x 2
PNM01602003921S

S

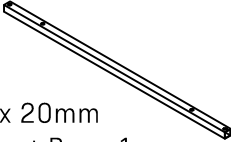

758 x 20mm
Support Bar x 1
PRM202007582A

Tools required

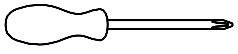

Phillips screwdriver
(small & medium)

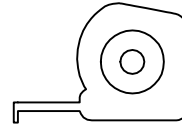

Ruler/tape
measure

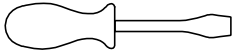

Flat-head screwdriver
(small & medium)

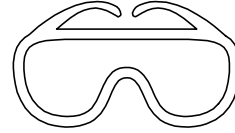

Eye protection
(when using a
hammer or glue)



Small
hammer

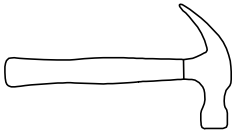

Large hammer

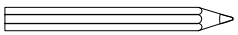

Pencil



Mallet

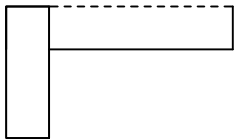

Set Square



Spirit Level

Panels

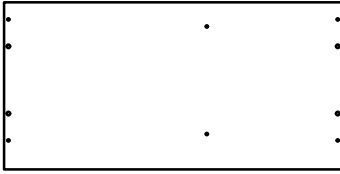

1 Top (803 x 397mm)

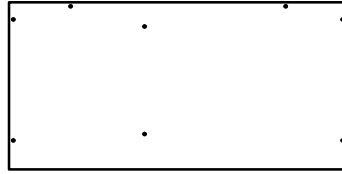

2 Bottom (803 x 397mm)



3 Right Shelf (454 x 353mm)

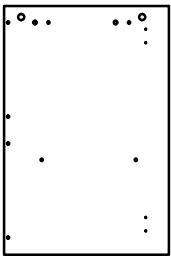

4 Right Side (592 x 391mm)

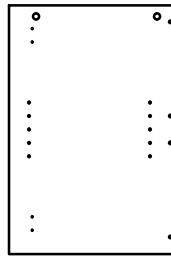

5 Left Side (592 x 391mm)

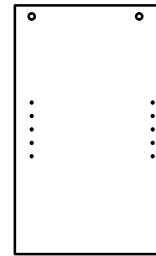

6 Center (592 x 354mm)



7 Wine Glass Holder (454 x 80mm) (x2)

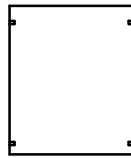

8 Shelf (295 x 353mm)

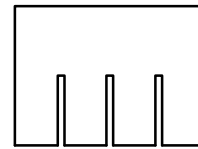

9 Wine Shelf (452 x 330mm)



10 Wine Partition (330 x 216mm) (x3)

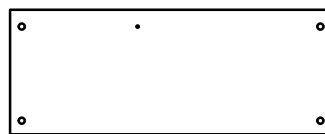

11 Upper Back (765 x 296mm)

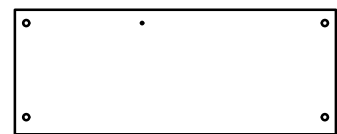

12 Lower Back (765 x 296mm)

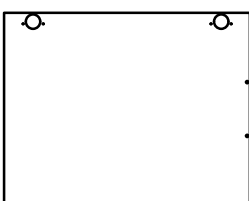

13 Right Door (584 x 458mm)

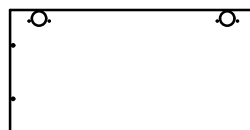

14 Left Door (584 x 296mm)

1

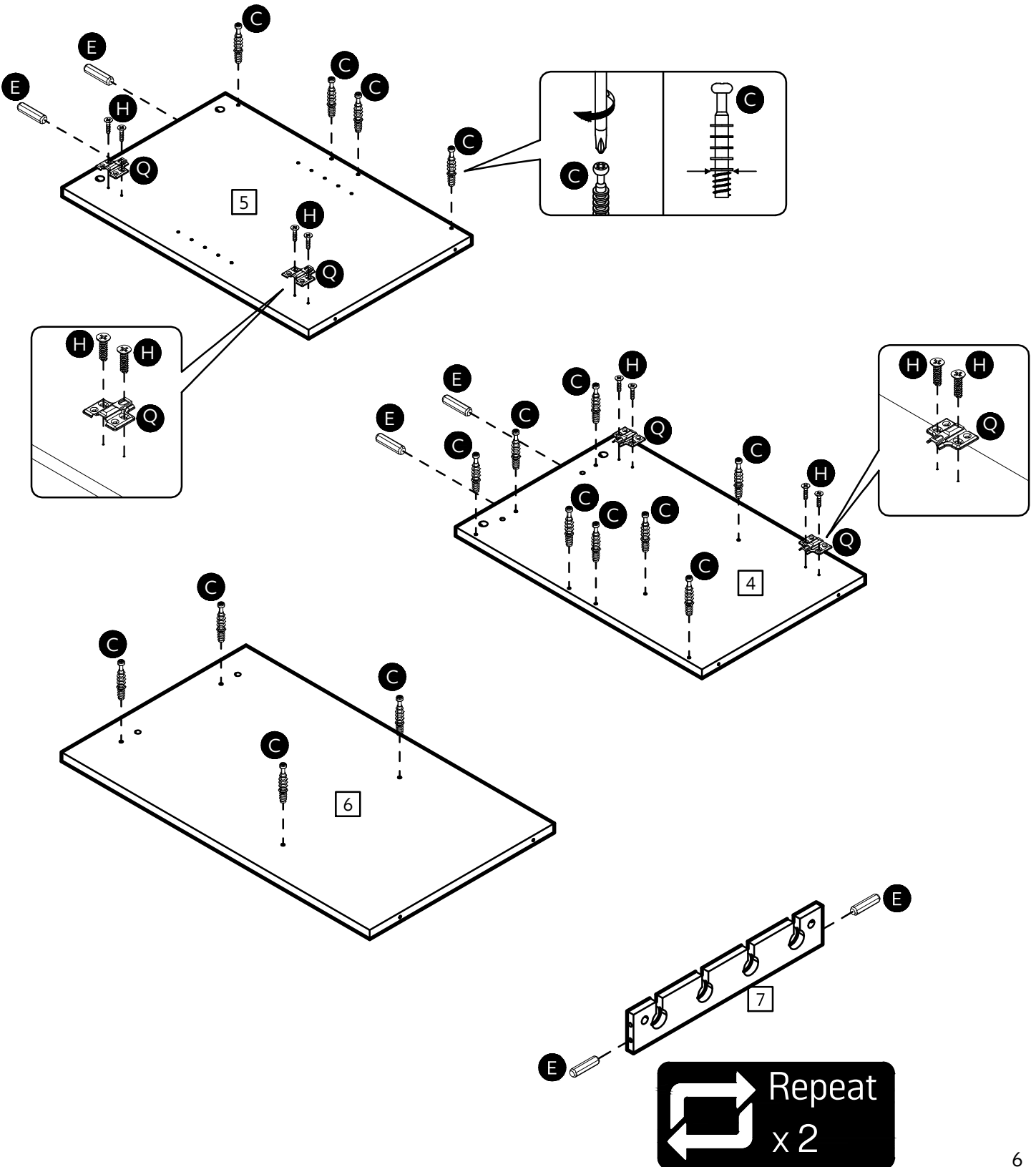
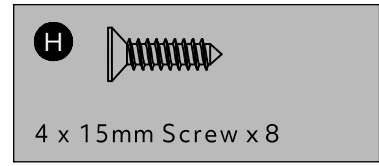
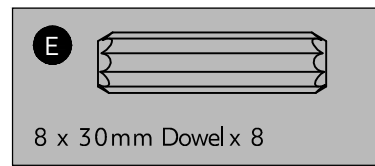
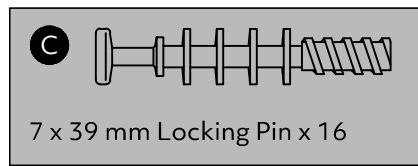
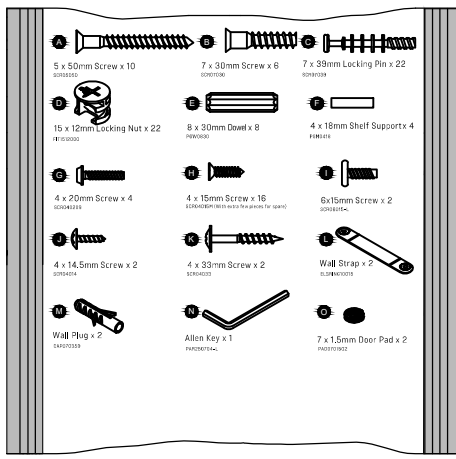

Repeat
x 2

2

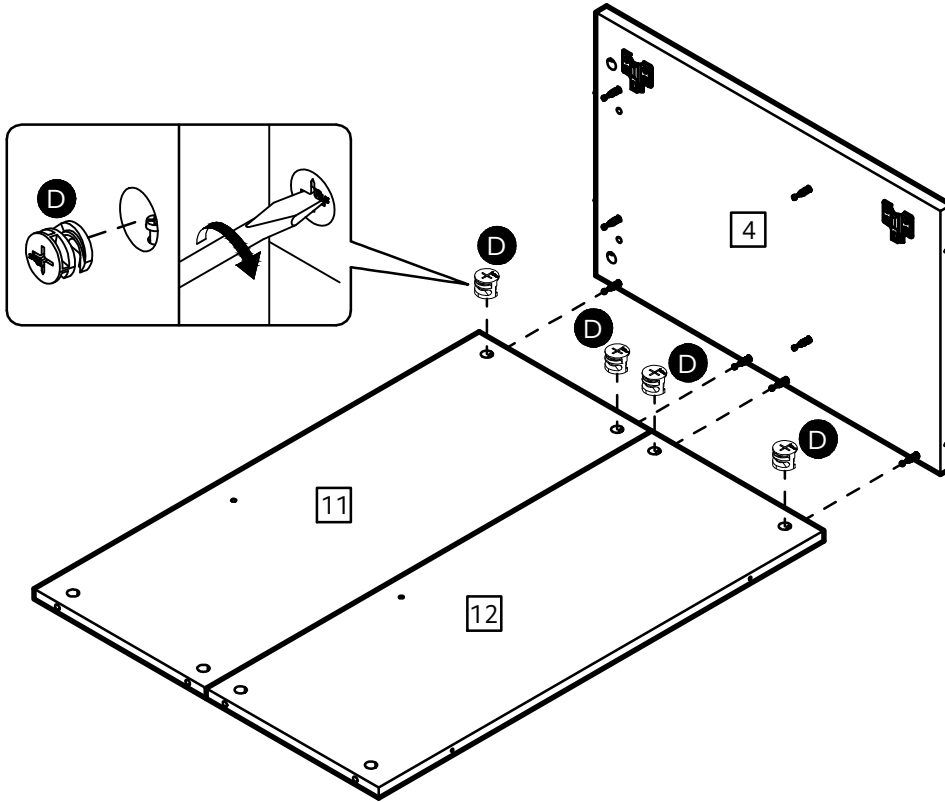
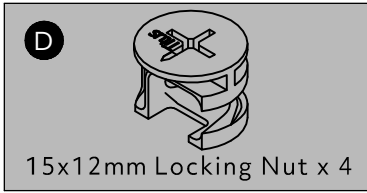

3

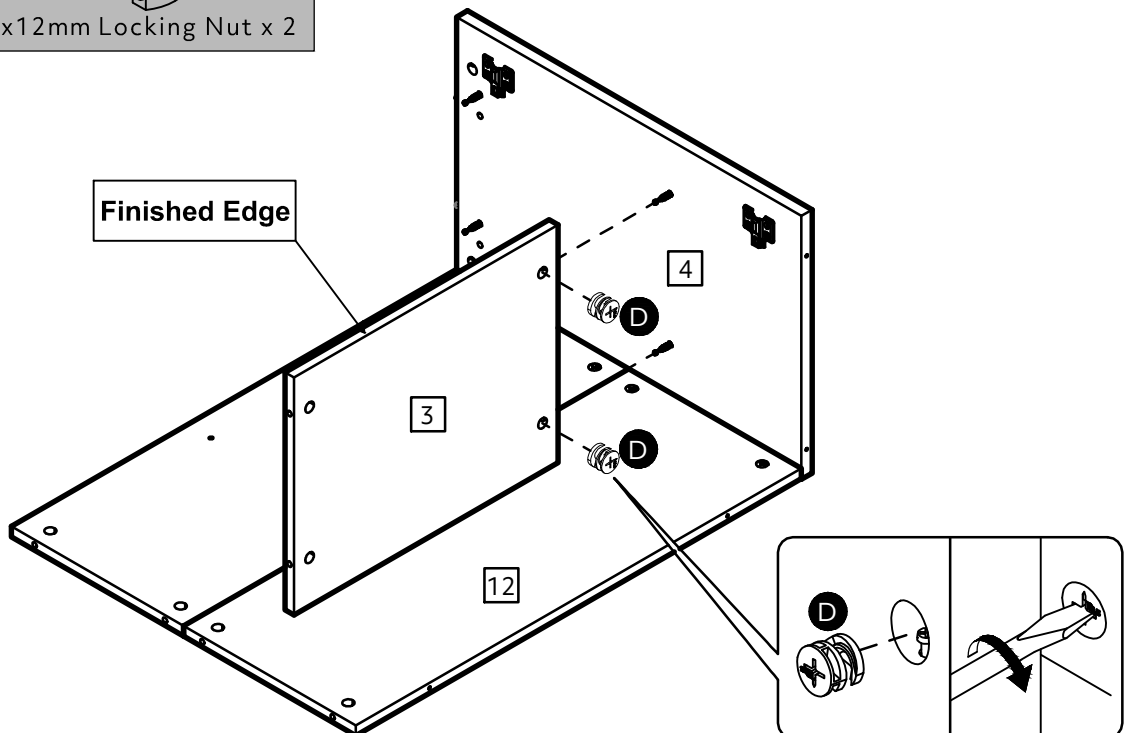
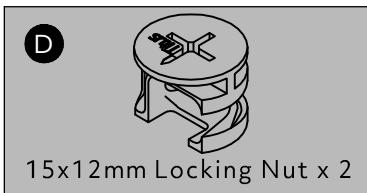

4

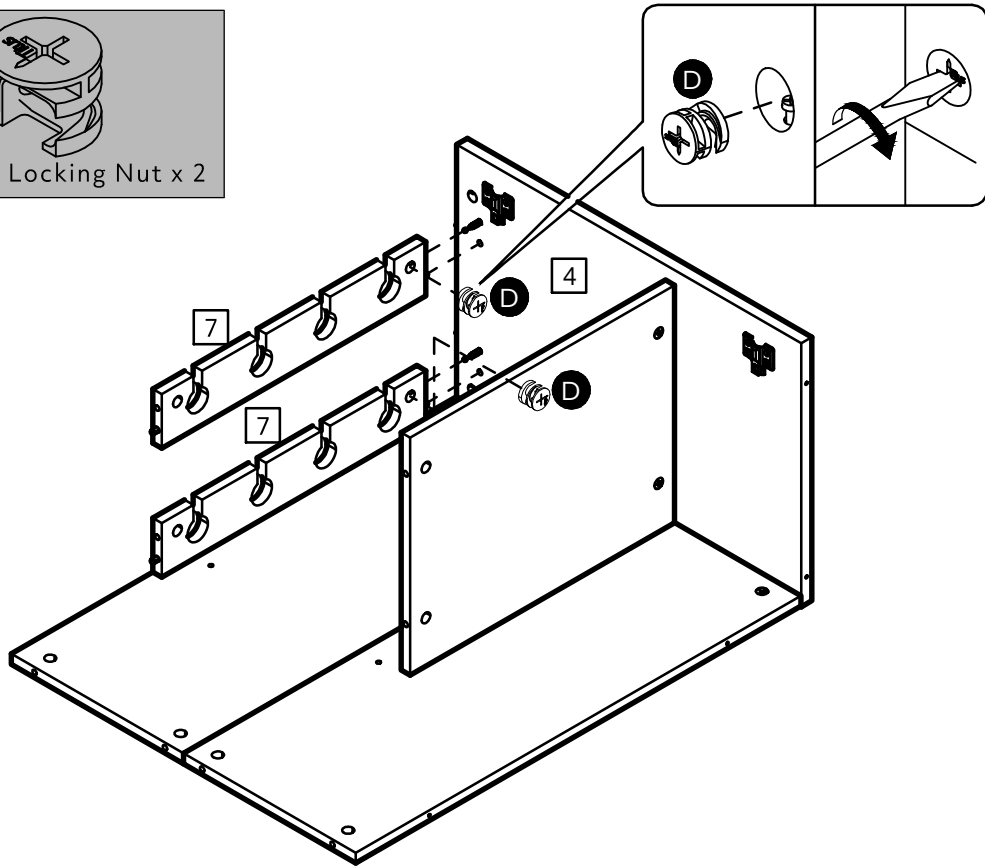
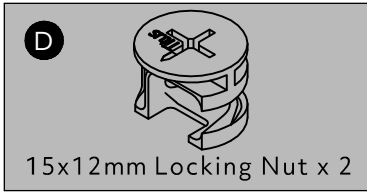

5

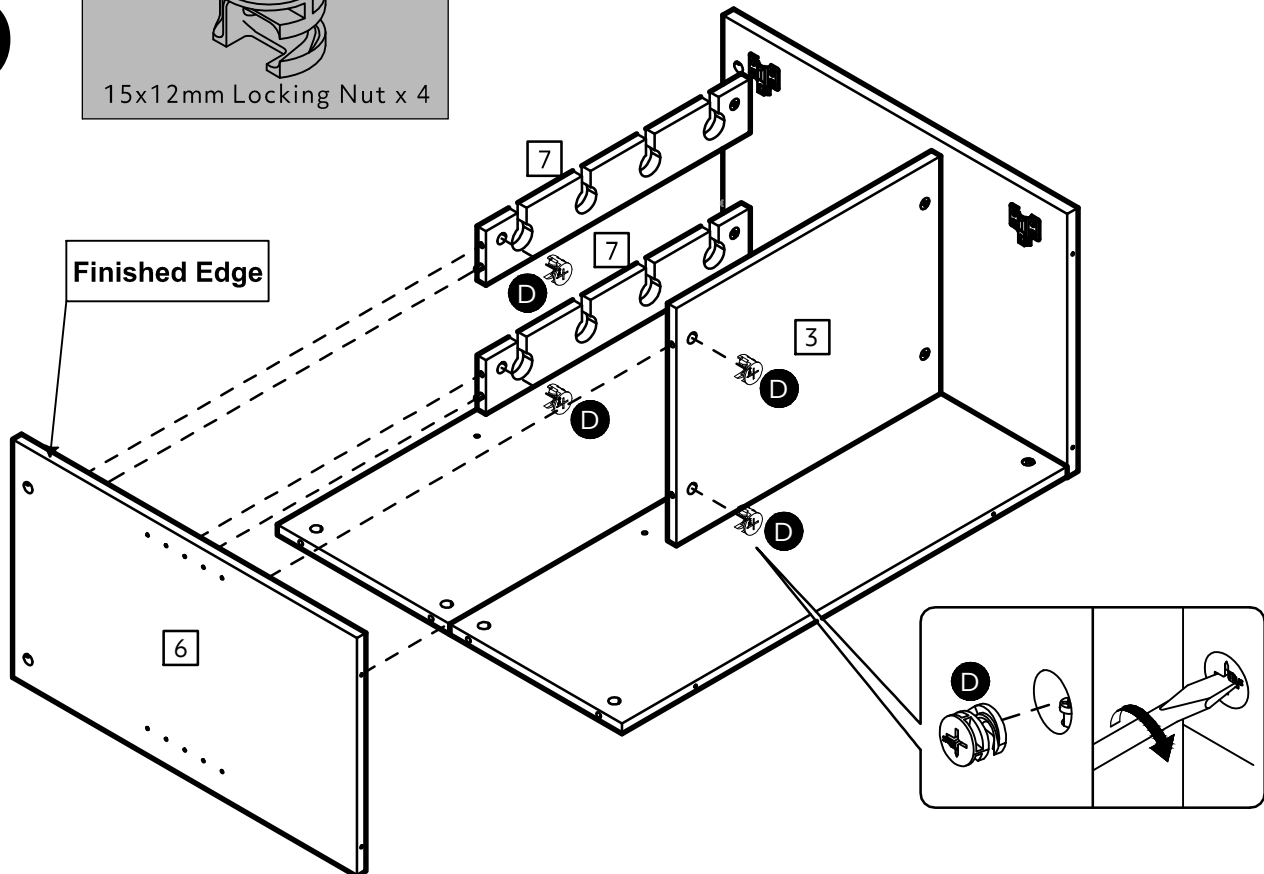
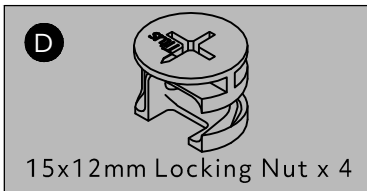

6

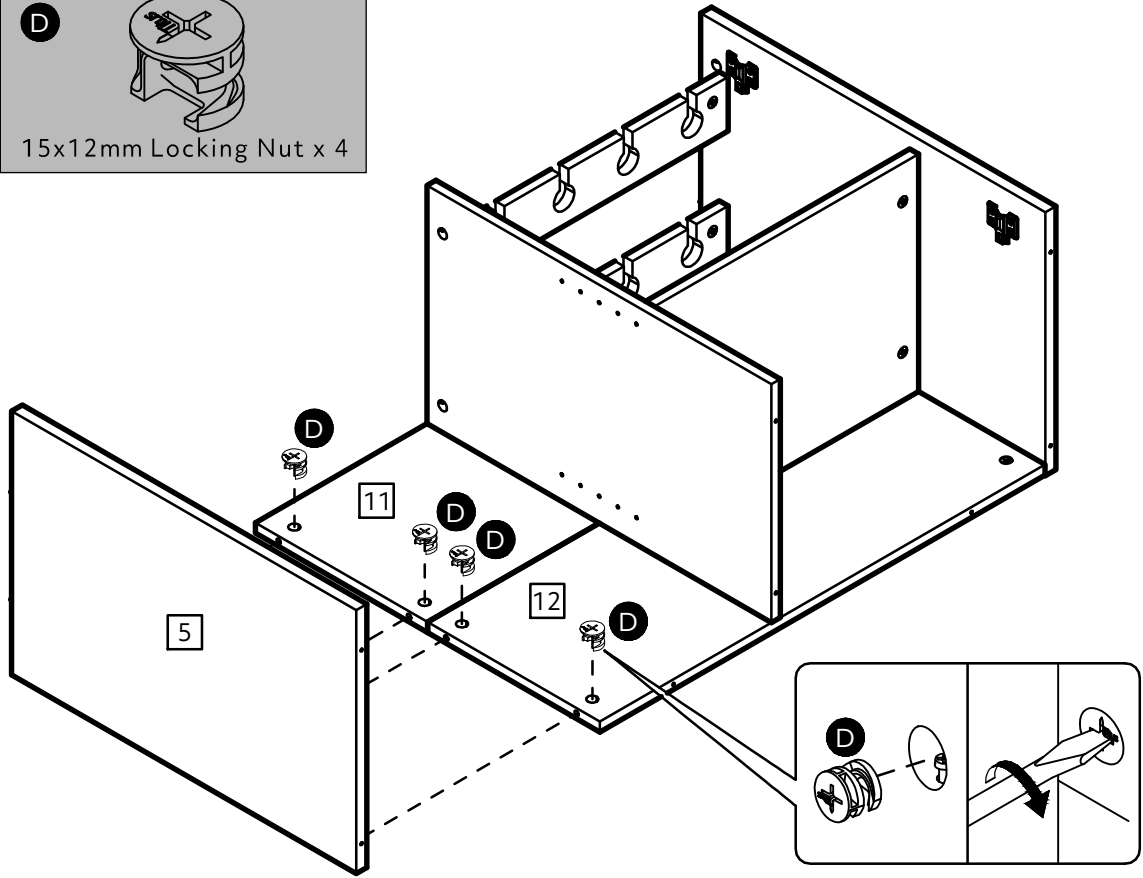
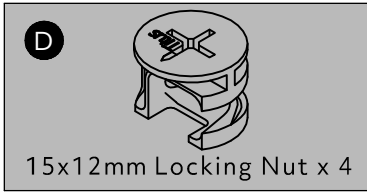

7

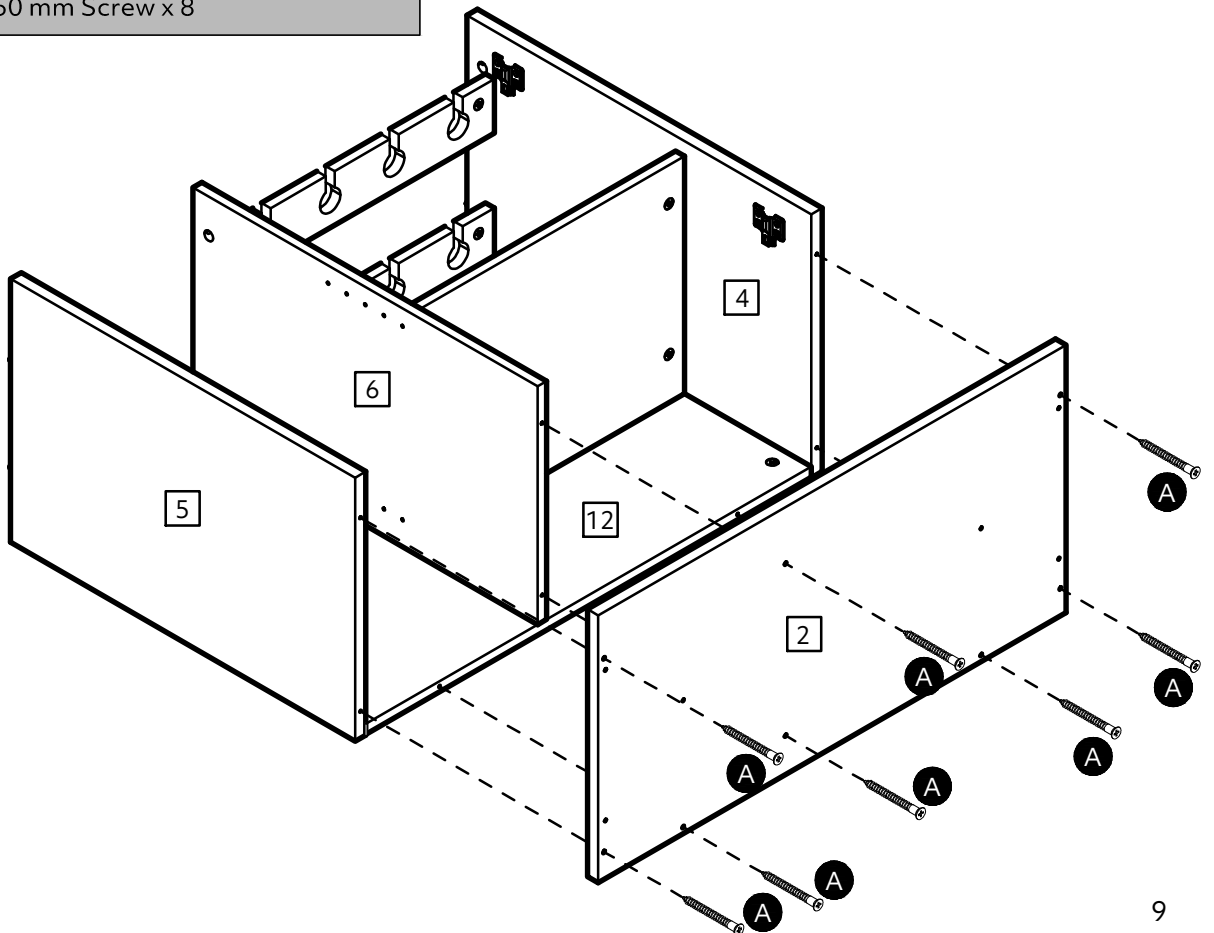
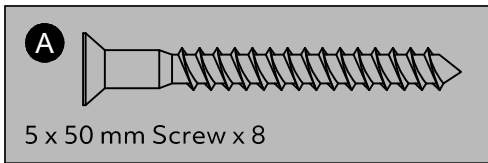

8

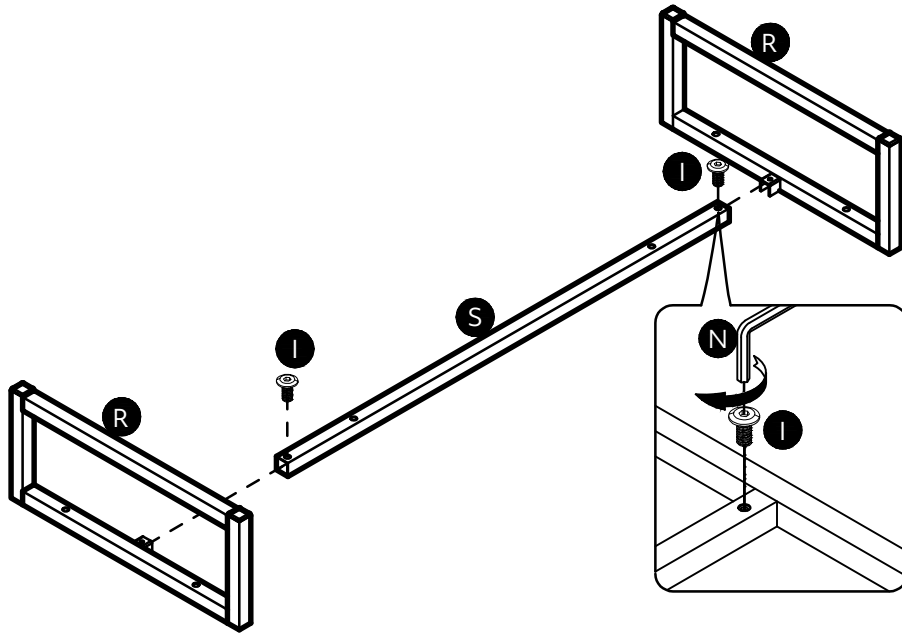
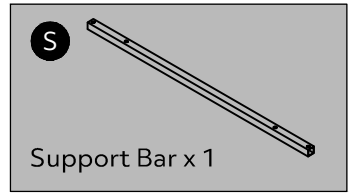
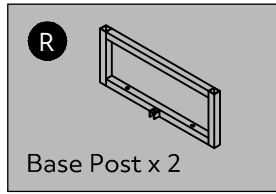
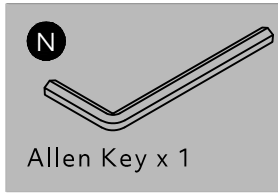
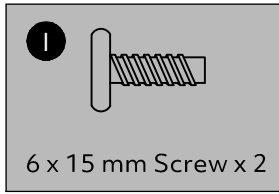

9

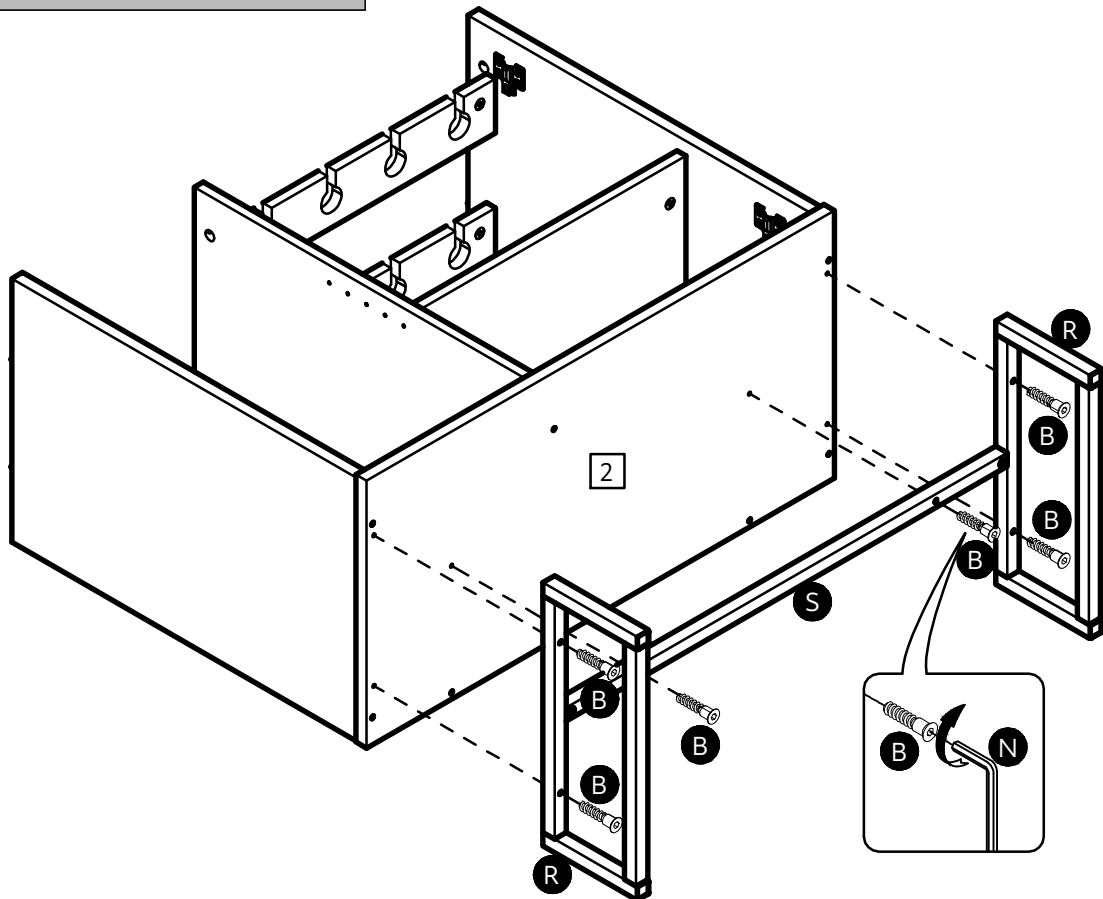
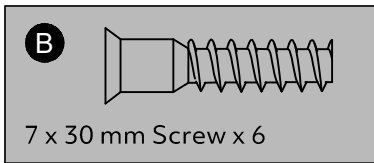

10

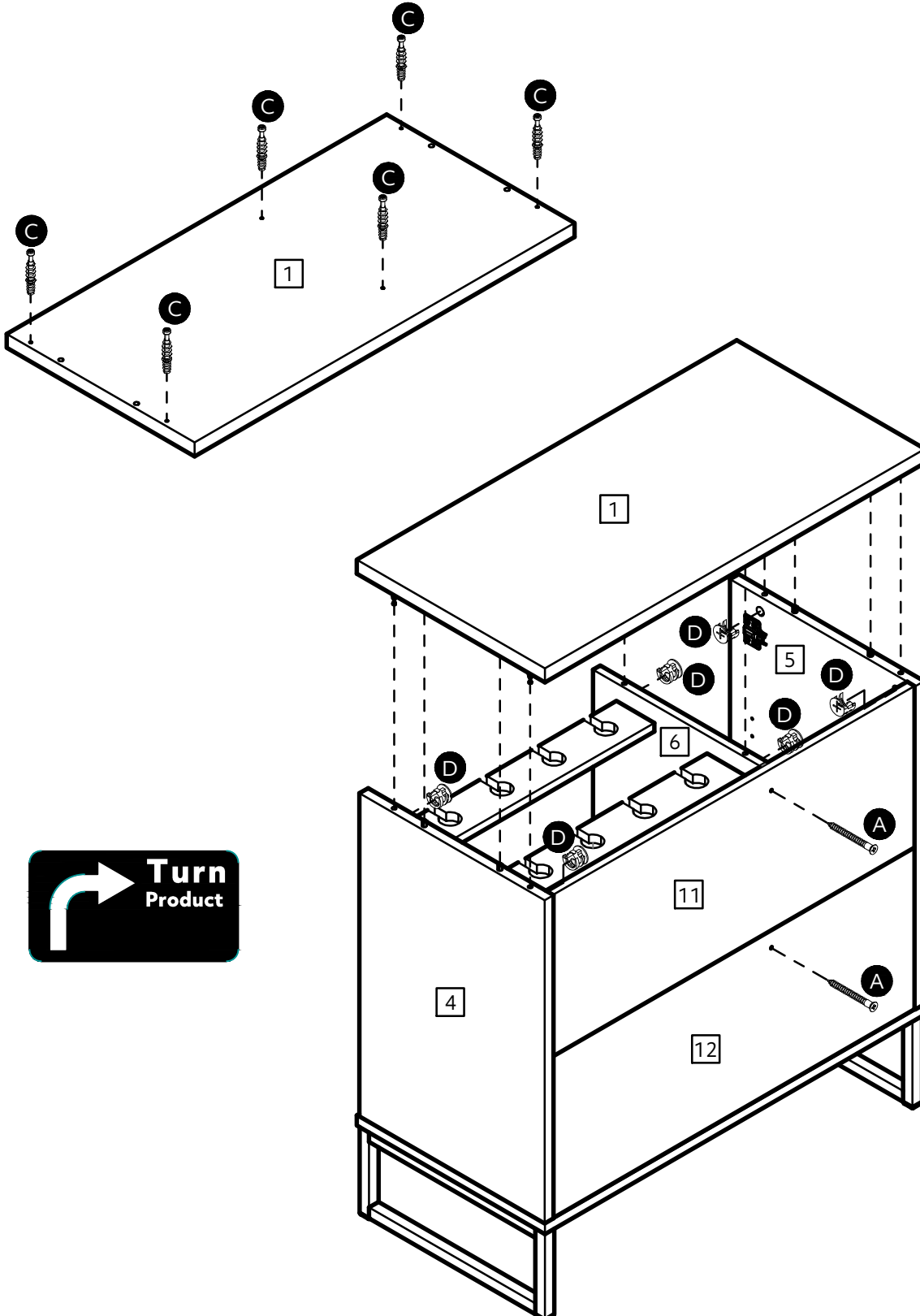
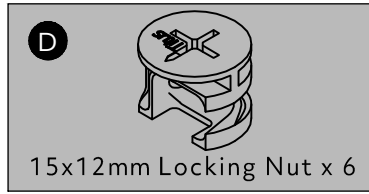
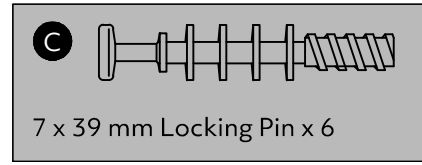
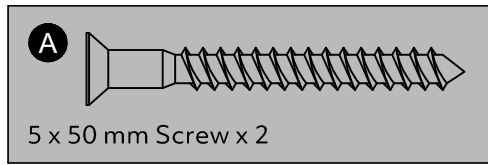

11

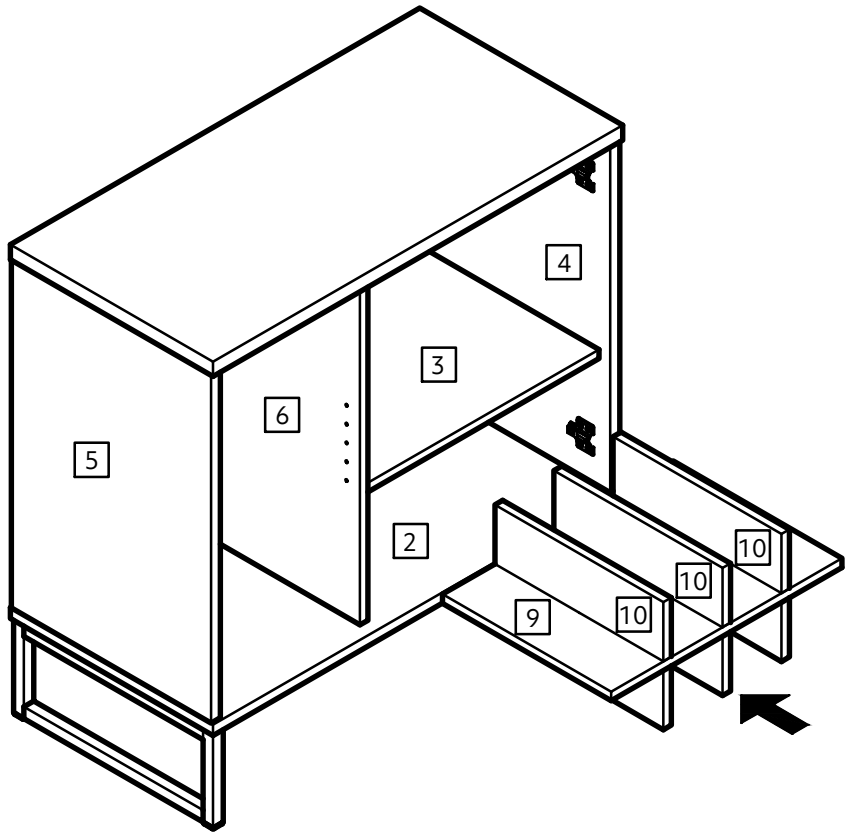
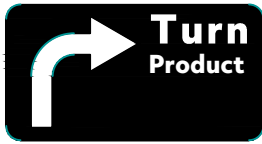
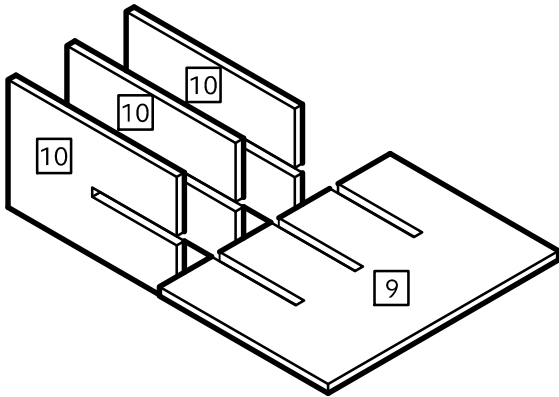

12

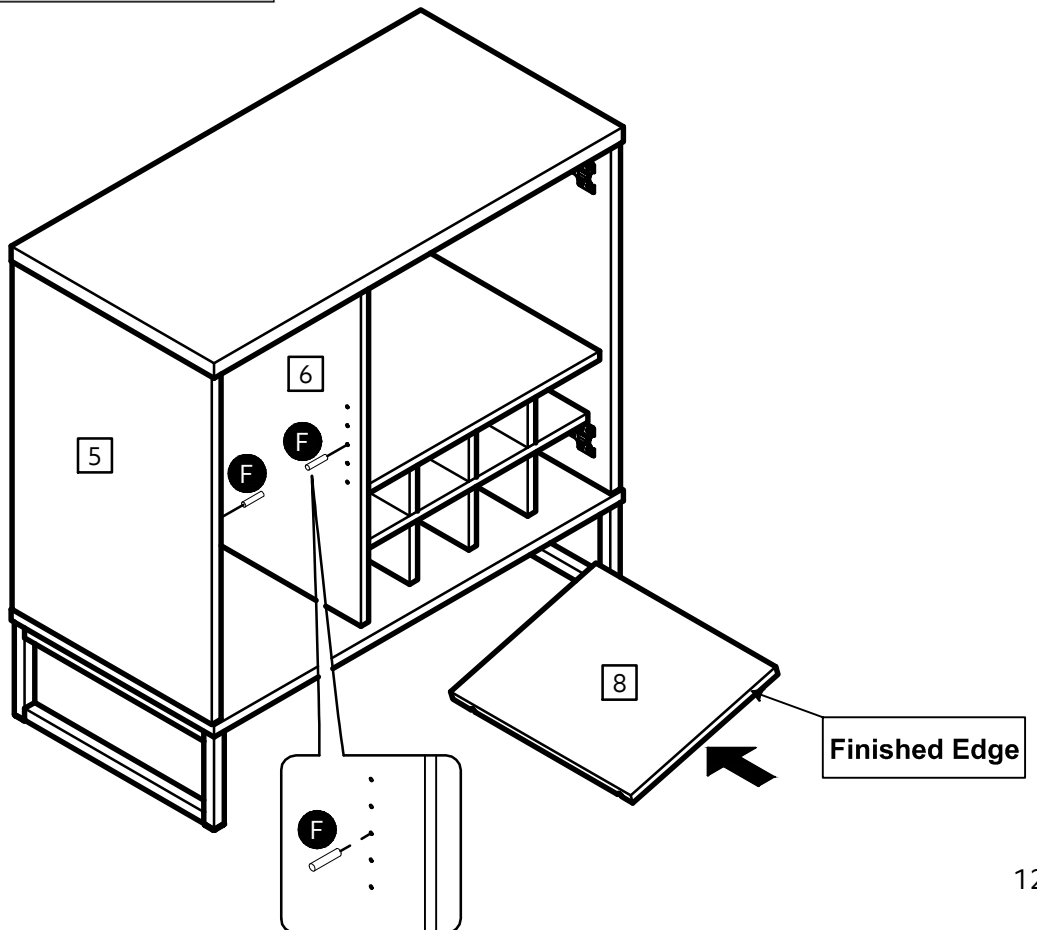
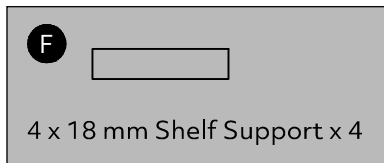

13

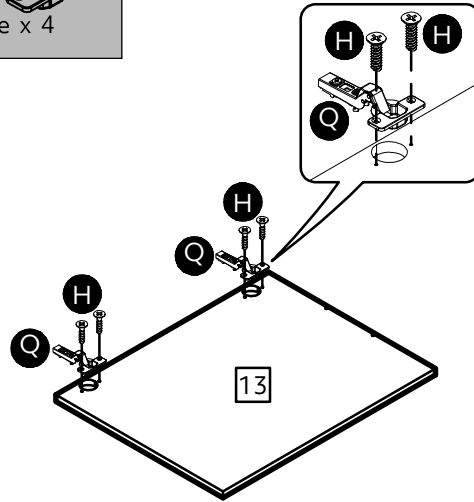
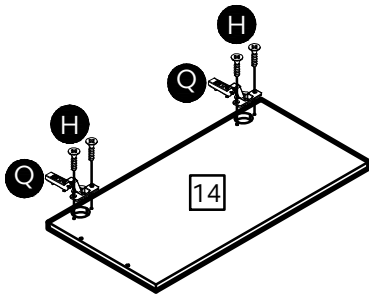
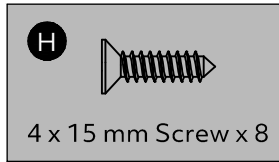

14

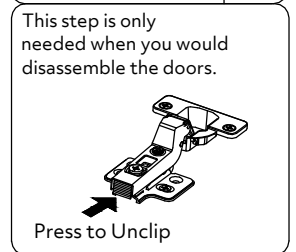
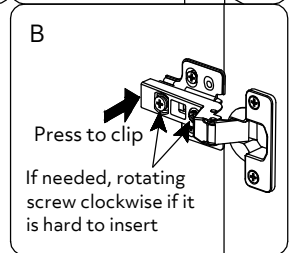
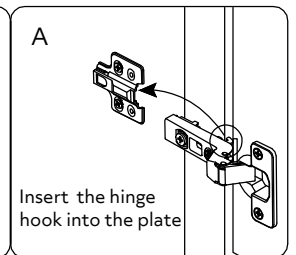
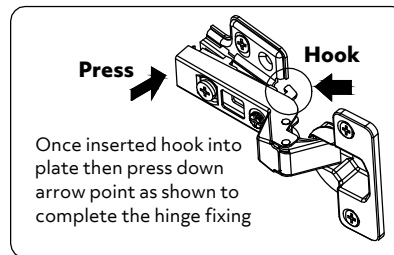
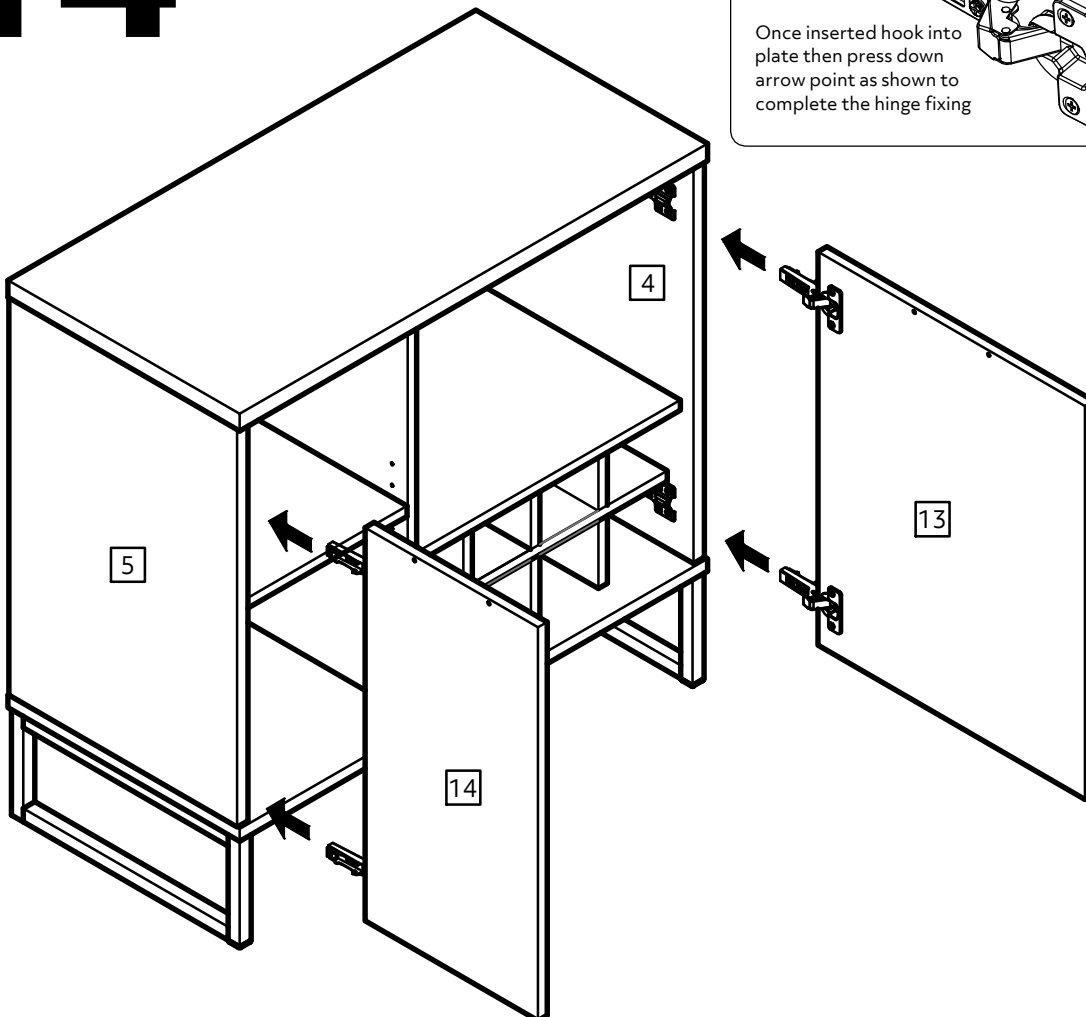

15

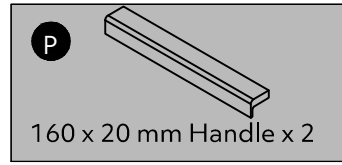
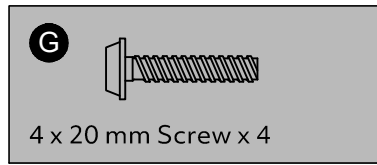

Hinges Adjustment

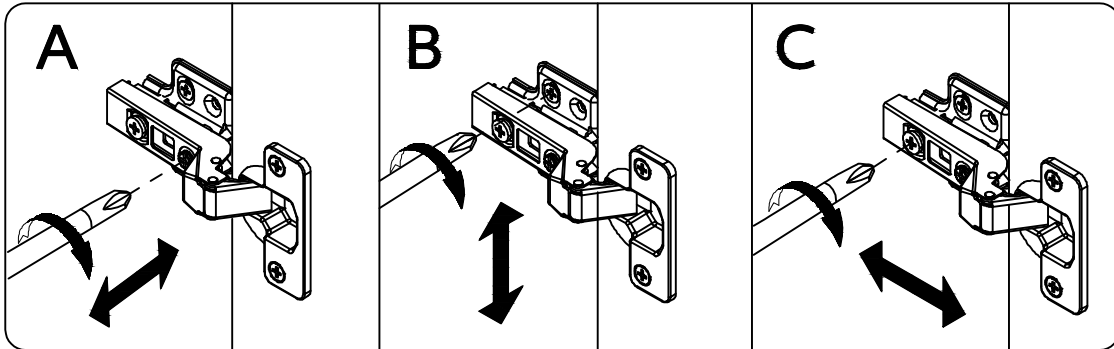

A. Side to side adjustment by clockwise or anticlockwise adjustment .

B. Up and down adjustment by adjusting mounting plate slot .

C. Front to back adjustment by rotating screw clockwise or anticlockwise.

NOTE

LOCK THE HINGE AFTER ADJUSTMENT!
IF NEEDED, ADD 2 SCREWS ON EACH MOUNTING PLATE
TO STRENGTHEN IT (WITH SPARE SCREWS INCLUDED).

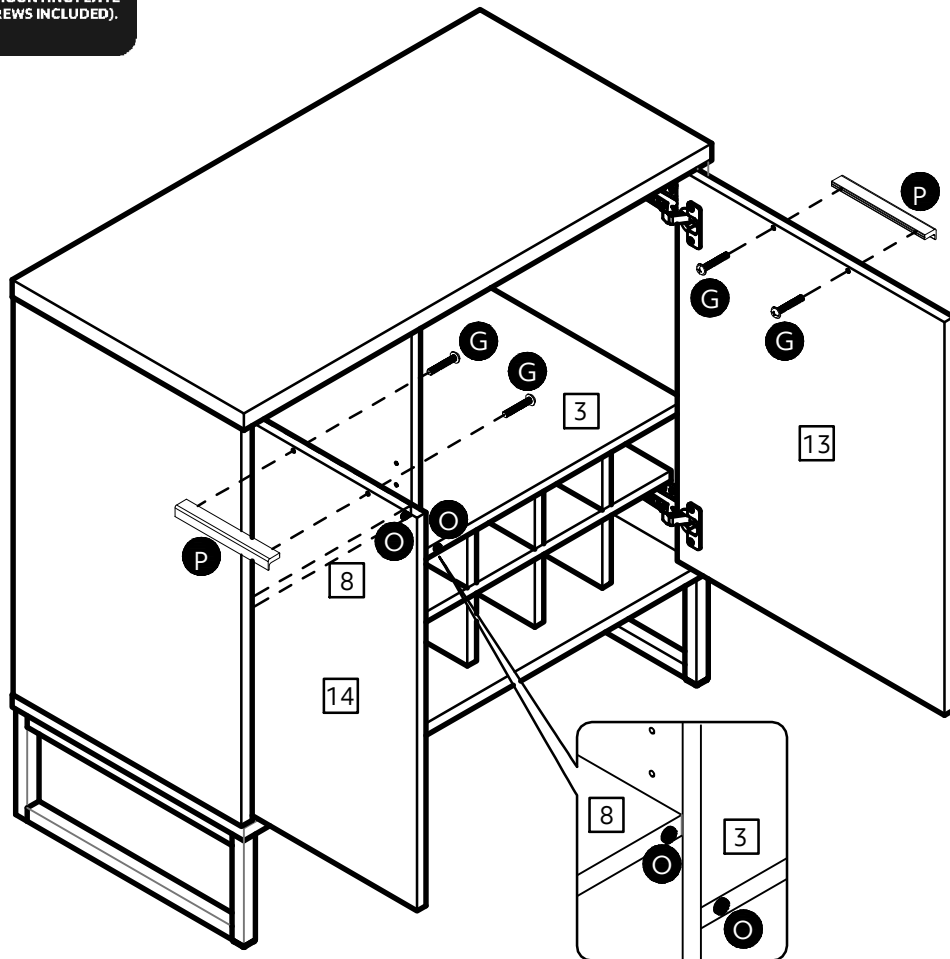

16

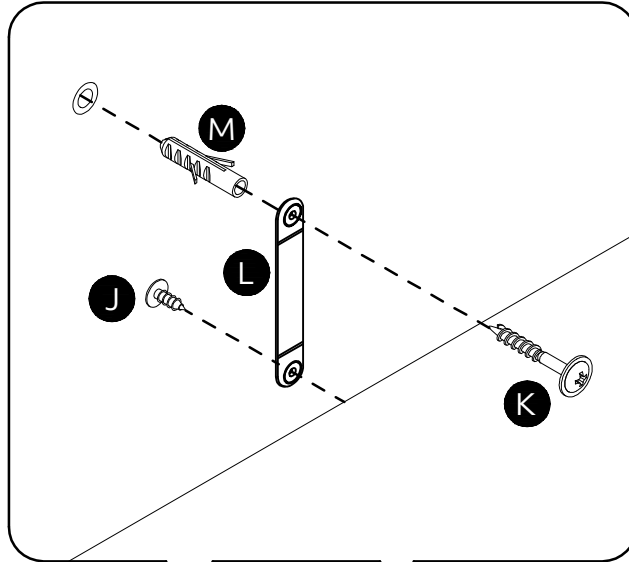
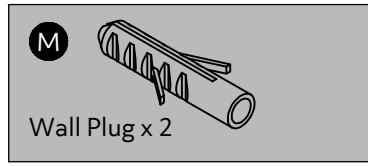
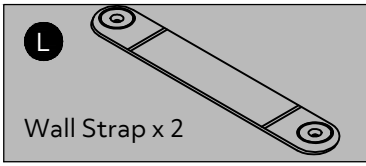
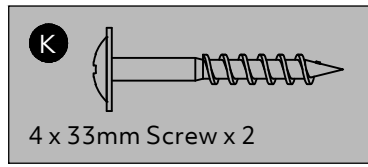
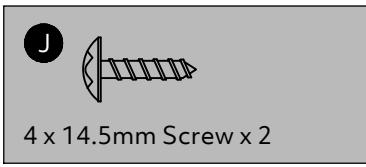

WARNING!
IN ORDER TO PREVENT OVERTURNING
THIS PRODUCT MUST BE USED WITH
THE WALL ATTACHMENT DEVICE
PROVIDED

NOTE
PLEASE REFER TO THE WALL MOUNTING &
FIXINGS GUIDE FOR WALL FIXING.

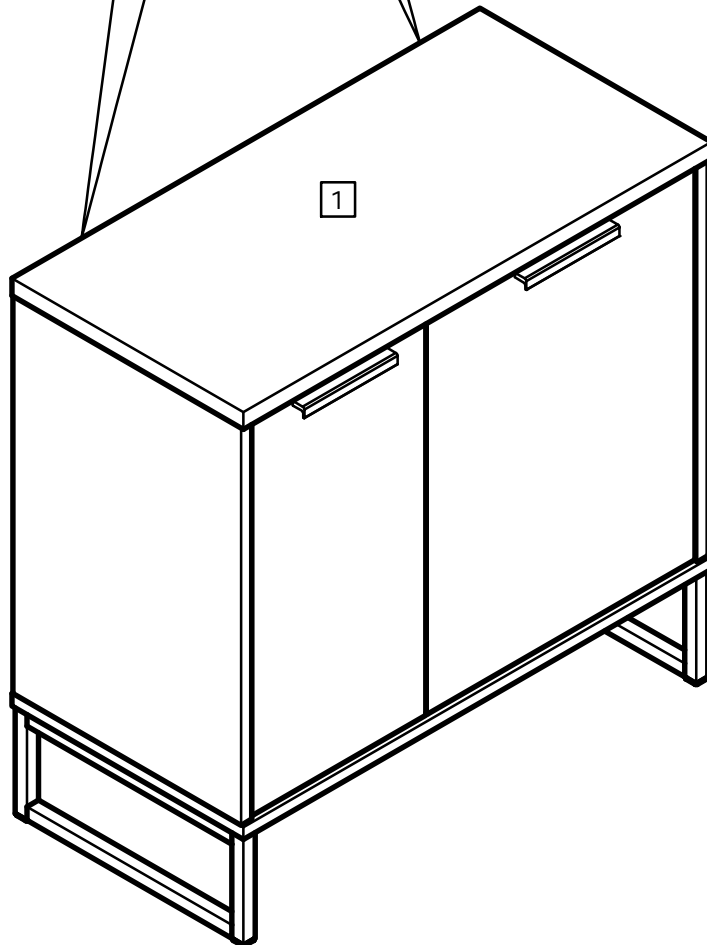

A Guide to - Wall Mounting & Fixings

Important note:

If plastic wall plugs are supplied with your product:



- these are only suitable for use in masonry walls.

If you are in any doubt about the correct wall plugs for your wall, seek professional advice.

Failure of the product due to using incorrect fixings is the responsibility of the installer.



Important: When drilling into walls always check that there are no hidden wires or pipes etc.

Make sure that the screws and wall plugs being used are suitable for supporting your unit. Consult a qualified tradesperson if you are unsure.

Hints:

- 1: General rule:**  Always use a larger screw and wall plug if you are not sure.
- 2:** Ensure you use the recommended drill bit to match the wall plug and hole size.
- 3:** Ensure you drill the hole horizontally, do not force the drill or enlarge the hole.
- 4:** Take extra care when drilling high walls, ceilings and ceramic tiles. Ensure wall plugs are inserted beyond the thickness of the ceramic tiles to avoid the tiles splitting or cracking.
- 5:** Ensure wall plugs are well fitted and are a tight fit in the drilled hole.

Types of walls

You can use one of the following types of wall plug if your walls are made of brick, breeze block, concrete, stone or wood.

No.1 "General Purpose" wall plug

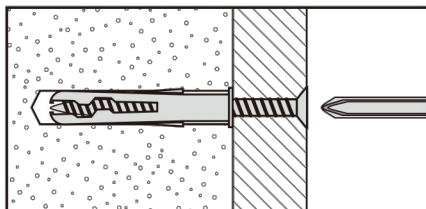

Generally aerated blocks should not be used to support heavy loads, use a specialist fitting in this case. For light loads, general purpose wall plugs can be used.

No.2 "Plasterboard" wall plug

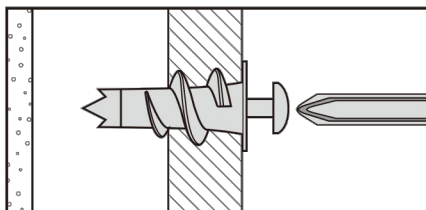

For use when attaching light loads on to plasterboard partitions.

No.3 "Cavity Fixing" wall plug

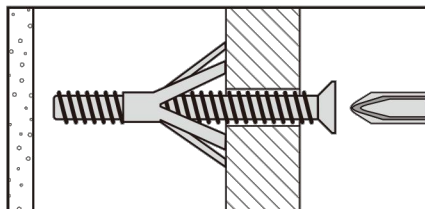

For use with plasterboard partitions or hollow wooden doors.

No.4 "Cavity Fixing-Heavy Duty" wall plug

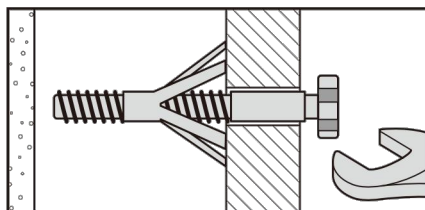

For use when fitting or supporting heavy loads such as shelving, wall cabinets and coat racks.

No.5 "Hammer Fixing" wall plug

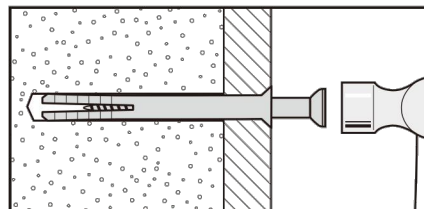

For use with walls stuck with plasterboard. The hammer fixing allows it to be fixed to the wall rather than the plasterboard. Always check the fixing is secure to the retaining wall.

No.6 "Shield Anchor" wall plug Heavy loads

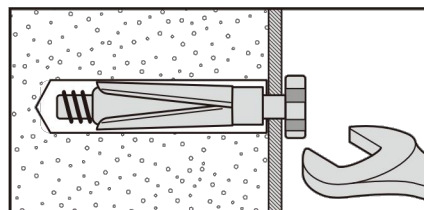

For use with heavier loads such as TV & HiFi speakers and satellite dishes etc.



Care & Maintenance

Safety: Always check the fitting and location to ensure your safety in and around the home.

Fitting: From time to time check the fitting to ensure the wall plugs or screws do not become loose.