

**Hisense**

life reimagined

EN

GB

IE

# **INSTRUCTIONS FOR USE**

## **COMBINED MICROWAVE OVEN**

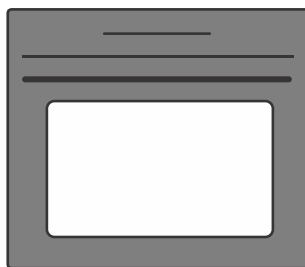

We thank you for your trust and the purchase of our appliance.

This detailed instruction manual is supplied to make the use of this product easier. The instructions should allow you to learn about your new appliance as quickly as possible.

Make sure you have received an undamaged appliance. If you do find transport damage, please contact the seller from which you purchased the appliance, or the regional warehouse from which it was supplied. The telephone number can be found on the invoice or on the delivery note.

Instructions for installation and connection are supplied on a separate sheet.

The following symbols are used throughout the manual and they have the following meanings:



**INFORMATION!**

Information, advice, tip, or recommendation



**WARNING!**

Warning – general danger



It is important that you carefully read the instructions.

# Contents

<b>1. Safety precautions</b> .....	<b>4</b>
1.1 Safe use of the microwave oven .....	5
<b>2. Other important safety warnings</b> .....	<b>7</b>
<b>3. Appliance description</b> .....	<b>10</b>
3.1 Appliance equipment .....	10
3.2 Control panel .....	11
<b>4. Before first use</b> .....	<b>12</b>
4.1 Switching on for the first time .....	12
<b>5. Microwave function</b> .....	<b>13</b>
<b>6. Using the oven – selecting the baking settings</b> .....	<b>14</b>
6.1 Professional baking mode .....	15
6.2 Time functions .....	18
6.3 Baking by steps .....	19
6.4 Automatic cooking mode .....	20
6.5 Automatic programs .....	21
6.6 Additional functions .....	22
<b>7. Starting the cooking process</b> .....	<b>23</b>
7.1 Additional browning – au gratin .....	23
<b>8. End of cooking by touching</b> .....	<b>24</b>
<b>9. General settings</b> .....	<b>25</b>
9.1 Locking keys .....	26
<b>10. General tips and advice for baking</b> .....	<b>27</b>
10.1 Cooking table .....	28
<b>11. Cleaning and maintenance</b> .....	<b>32</b>
11.1 Cleaning the oven (Steam Clean) .....	33
11.2 Removing and cleaning the wire guides .....	33
11.3 Replacing the bulb .....	34
<b>12. Troubleshooting</b> .....	<b>35</b>
12.1 Troubleshooting table .....	35
12.2 Label – appliance information .....	35
<b>13. Cooking test</b> .....	<b>36</b>

# 1. Safety precautions

## **IMPORTANT SAFETY PRECAUTIONS – CAREFULLY READ THE INSTRUCTIONS AND SAVE THEM FOR FUTURE REFERENCE.**

Appliance must be connected to fixed wiring which has incorporated means of disconnection. Fixed wiring must be made in accordance with the wiring rules.

Means for disconnection must be incorporated in the fixed wiring in accordance with the wiring rules.

The appliance must not be installed behind a decorative door in order to avoid overheating.

If the supply cord is damaged, it must be replaced by the manufacturer, its service agent or similarly qualified persons in order to avoid a hazard (only for appliances supplied with connection cord).

This appliance can be used by children aged 8 years and above, and by persons with reduced physical, sensory or mental capabilities or lack of experience and knowledge, if they have been given supervision or instruction concerning the use of the appliance in a safe way, and if they understand the hazards involved. Children shall not play with the appliance. Cleaning and user maintenance shall not be done by children without supervision.

**WARNING:** Accessible parts may become hot during use. Young children should be kept away.

**WARNING:** The appliance and some of its accessible parts may become very hot during use. Care should be taken to avoid touching heating elements. Children less than 8 years of age shall be kept away unless continuously supervised.

The appliance is not intended to be controlled by external timers or separate remote control system.

Do not use harsh abrasive cleaners or sharp metal scrapers to clean the oven door glass/ the glass of hinged lids of the hob (as appropriate), since they can scratch the surface, which may result in shattering of the glass.

Do not use steam cleaners or high-pressure cleaners to clean the appliance as this may result in an electric shock.

**WARNING:** Before replacing the light bulb, make sure the appliance has been disconnected from the mains power, in order to prevent the hazard of an electric shock.

Never pour water directly on the bottom of the oven cavity. Temperature differences could result in damage to the enamel coating.

### **1.1 Safe use of the microwave oven**

**WARNING:** Due to the extremely high temperatures generated when the appliance is used in combination mode, it is recommended that children only use the oven under adult supervision.

**WARNING:** If the door or door seals are damaged, the oven must not be operated until it has been repaired by a competent person.

**WARNING:** It is extremely hazardous for anyone other than a competent person to carry out any service or repair operation that involves the removal of covers protecting against exposure to microwave energy.

**WARNING:** Liquids and other foods must not be heated in sealed containers since they are liable to explode.

The appliance is intended for use in households and similar environments, such as:

- staff pantries in stores and other working environments;
- family farms;
- accommodation units for guests at hotels, motels, and other accommodation or lodging establishments;
- bed and breakfast establishments.

Only use utensils suitable for use in microwave ovens.

When cooking with microwaves, do not use metal containers for food or beverages.

When heating food in plastic or paper containers, keep an eye on the oven, as such packaging may ignite.

Microwave heating of beverages can result in delayed eruptive boiling. Therefore, take care when handling the container with the heated beverage. To prevent this, place a non-metal object (e.g., a wooden, glass, or plastic spoon) into the container during the heating-up process.

To avoid burns, the contents of baby bottles and baby food jars should be shaken or stirred, and their temperature checked before feeding.

Eggs in their shell should not be heated in microwave ovens since they may explode even after microwave heating has ended.

If you observe smoke, switch off or unplug the appliance and keep the oven door closed to stifle any flames.

The microwave oven is intended for heating food and beverages. Drying food or clothing and heating of hot packs or pads, slippers, sponges, moist cloths etc. may result in injury, ignition, or fire.

The oven should be cleaned regularly, and any food deposits should be removed.

Failure to maintain the oven in a clean condition could lead to deterioration of the surface that could adversely affect the life of the appliance and possibly result in a hazardous situation.

If the appliance is integrated into a kitchen cupboard with a door, the cupboard door should be open while the appliance is in use.

## **2. Other important safety warnings**

The appliance is intended for household use. Do not use it for any other purpose, such as room heating, drying of pets or other animals, paper, fabrics, herbs etc. As this may lead to injury or fire hazard.

Appliance must be connected to fixed wiring which has incorporated means of disconnection. Fixed wiring must be made in accordance with the wiring rules.

We recommend that (due to appliance weight) at least two persons carry and install the appliance.

Do not lift the appliance by holding it by the door handle.

Oven door hinges may be damaged when under excessive load. Do not stand or sit on the open oven door, and do not lean against it. Also, do not place any heavy objects onto the oven door.

If the power cords of other appliances located in the vicinity of the oven become entangled in the oven door, they may get damaged, which may cause a short circuit. Therefore, make sure that the power cords of other appliances are at a safe distance.

Make sure the vents are never covered or obstructed in any other way.

Do not line the oven walls with aluminium foil and do not place baking trays or other containers on the bottom of the oven. This would reduce air circulation in the oven, obstruct and slow down the baking process and destroy the enamel coating.

We recommend you avoid opening the oven door during baking, as this increases power consumption and increases condensate accumulation.

At the end of the baking process, and during baking, be careful when opening the oven door, as there is danger of scalding.

To prevent limescale accumulation, leave the oven door open after baking or using the oven, to allow the oven cavity to cool down to room temperature.

Clean the oven when it has completely cooled down.

Eventual mismatches in colour shades between different appliances or components within a single design line may occur due to various factors, such as different angles under which the appliances are observed, different coloured backgrounds, materials, and room illumination.

Do not use the appliance if it is damaged. Unplug the appliance from the power mains and call an authorized service centre.

The oven can be safely used with or without baking pan guides.

Do not store items in the oven, which could cause danger when the oven is switched on.

**Heed** the minimum distance between the upper edge of the oven and the closest object above it.

The microwave oven is intended for heating food and beverages. Drying food or clothing and heating of hot packs or pads, slippers, sponges, moist cloths etc. may result in injury, ignition, or fire.

**Always use oven mitts** to remove dishes from the oven. Some pots, pans, or trays may absorb the heat from the food and thus become very hot.

Make sure to **only use the cookware** that is suitable for use in a microwave oven. Do not use steel cookware or cookware with golden or silver decorative edges or ornaments.

**Do not leave any accessories or utensils** in your oven when it is off. Do not switch on an empty oven to avoid damaging it.

**Do not use** porcelain, ceramic, or earthenware cookware if such materials are porous or if such cookware is not glazed on the inside. Once heated up, the moisture that would penetrate these pores could cause cracking. Only use cookware intended for use in a microwave oven.

**Always read** and observe the instructions for heating in a microwave oven, specified on the food packaging.

**Be careful** when heating alcohol-containing food, as a combustible mixture of alcohol and air may form inside the oven. Be careful when opening the door.

Use of metal cookware, forks, spoons, knives or staples or fasteners on frozen food packages is not recommended when **cooking or heating with microwaves** or a combination of microwaves and convection baking. After heating, stir the food or leave it to rest until the heat is evenly distributed.



Do not connect the appliance to power supply if an ELCB (earth-leakage circuit breaker) is installed in the power supply circuit.



**WARNING!**

**Carefully read the instructions for use before connecting the appliance. Repair or any warranty claim resulting from incorrect connection or use of the appliance shall not be covered by the warranty.**

## 3. Appliance description



### WARNING!

Appliance functions and equipment depend on the model.

Basic equipment of your appliance includes wire guides, shallow baking tray, and a wire rack.

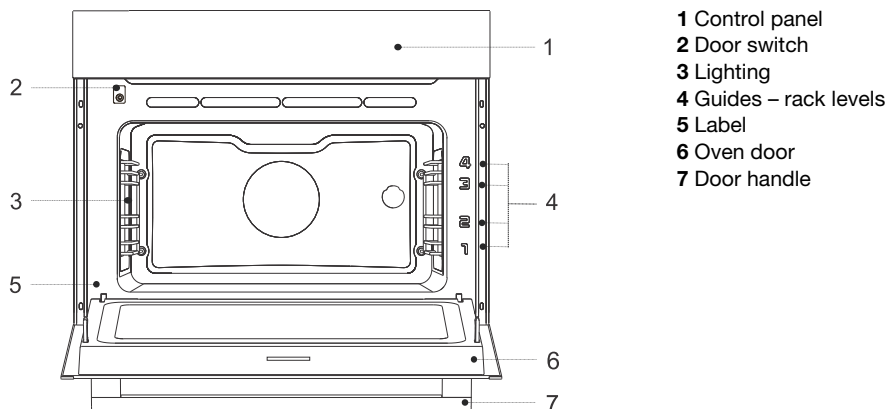

### 3.1 Appliance equipment

#### Oven door switch

If the oven door is opened during oven operation, the switch turns off the heaters, microwaves, and fan in the oven cavity. When the door is closed, the switch turns the appliance operation back on.

#### Guides

**Wire guides** – always insert the wire rack and baking tray into the guide.

**Fixed pull-out guides** – place the equipment on the guide. On the same guide, you can place the rack together with the drip pan.

NOTE: Equipment insertion guides are counted from the bottom up.

#### Oven equipment and accessories



### WARNING!

**Never use the wire rack, the shallow baking tray or the deep baking tray or any other metal part or accessory when operating a system with microwaves.**

1. **Wire rack** – used for grilling/broiling or as support for a pan, baking tray or baking dish.

NOTE: When inserting the wire rack into the guide, always make sure its elevated part is at the back and on the top side.

There is a safety latch on the wire rack. Therefore, the wire rack has to be lifted slightly at the front when pulling it out from the oven.

2. **Shallow baking tray** – used for flatbreads and small cakes. It can also be used as a drip tray.

NOTE: A shallow baking tray may become deformed when heated in the oven. When it cools down, it returns to its original state. The deformation does not affect its functionality.

3. **Glass baking tray** – is intended for cooking with all oven systems and for cooking with microwaves. It can also be used as a serving tray.

4. **Deep all-purpose baking tray** – used for baking vegetables and moist pastries. It can also be used as a drip tray.

NOTE: Never insert the deep all-purpose (or universal) baking tray into the first guide when baking.

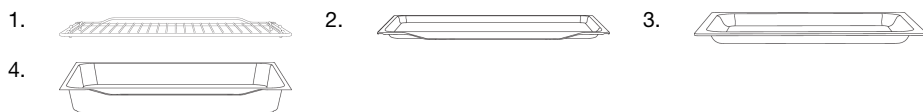

## 3.2 Control panel

(depending on the model)



Key		Use
1	ⓘ	Switching the oven on and off
2	▼▼▼ 250°	Additional browning – au gratin
3	°C W	Setting the temperature and power level.
4	▶ ◻	Starting and stopping Confirming a setting
5		Display of current settings in the oven.



Briefly touch the – key  
to select settings



Press the – key for 5 secs  
for additional settings or quick changes



### INFORMATION!

For better key responsiveness, touch them with a large area of your fingertip. Each time you press a key, this will be acknowledged by an acoustic signal (when this function is available).





## 4. Before first use

1.	Remove oven accessories and any packaging (cardboard, polystyrene foam) from the oven.
2.	Wipe the oven accessories and interior with a damp cloth. Do not use abrasive or aggressive cloths or cleaners.
3.	Turn on the oven (see chap. 4.1 <i>Switching on for the first time</i> )
4.	Preheat the oven to 250 °C for approximately one hour using the top and bottom heater system (see chapter Professional baking mode).
NOTE: During heating, the characteristic "new smell" is released, so ventilate the room thoroughly during this time.	

### 4.1 Switching on for the first time

After connecting your appliance or after an extended power outage, 12:00 will flash on the display.

First select and confirm the basic settings below (exact time, beep volume and display illumination).

1.		With the key < or > set the exact time of day. Confirm your selection with  .
2.		The display will show <b>VoL</b> . With the key < or > increase or decrease the volume of beeps.
3.		When you touch > the display will show <b>brht</b> . With the key < or > increase or decrease the intensity of the display illumination.
4.		To exit the basic settings, touch > .

# 5. Microwave function

Microwaves are used for **cooking, roasting, and defrosting of food**. They allow quick and efficient cooking without changing the colour or shape of the food.

Microwaves are a type of electromagnetic radiation. Such radiation is commonly found in our environment in the form of radio-electric waves, light or infrared rays. Microwave frequency is in the 2,450 MHz range.



### WARNING!

**Never use or activate a microwave system if the oven is empty.**

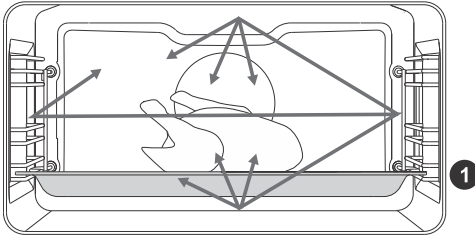

Following are their characteristics:

- microwaves are reflected by metals,
- microwaves travel through other materials,
- microwaves are absorbed by water, fat, and sugar molecules.

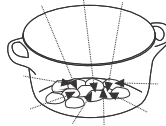
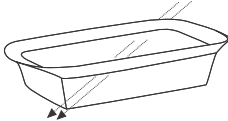
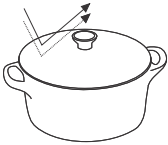

When food is exposed to microwaves, the molecules begin to move rapidly, thereby generating heat. The microwaves penetrate approximately 2.5 cm deep into the food. If the food is thicker, the core of the food will be cooked by conduction, as in conventional cooking.

# 6. Using the oven – selecting the baking settings

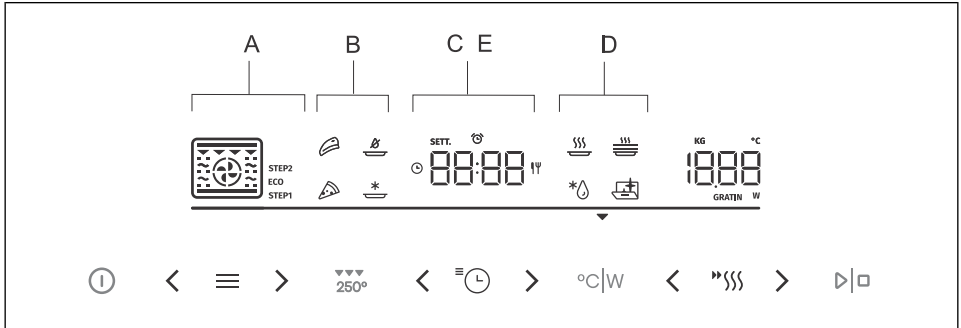

Key	Use
<	Left selection key
≡	Baking selection key. By touching the key, you can select: <b>A</b> Professional mode <b>Pro</b> – allows you to set the baking parameters (baking system, temperature, quick preheating, and baking time) at your discretion. <b>B</b> Automatic mode <b>Auto</b> – special preset programmes which you can also change. <b>C</b> Automatic programmes <b>ProG</b> (Pr01 to Pr22) <b>D</b> Additional functions <b>Othr</b> <b>E</b> General settings <b>SEtt</b>
>	Right selection key
≡⌚	Key for setting time functions and general settings
»»»	Key for setting the quick preheat function and gratin function

NOTE: The display only illuminates the keys that can be used to set and confirm the selected setting.

Symbol	Meaning
	Baking systems
STEP1	Baking by steps (STEP1, STEP2)
⌚	Time function – baking time
⌚	Time function – delayed end
⌚	Minute minder
»»»	Fast preheat
GRATIN	GRATIN function for extra top crust at the end of baking.

NOTE: Some symbols on the display appear as slightly illuminated (the function is in standby mode). If you press the key to select a symbol and confirm it, the symbol's intensity will increase. This is when the function is active.

## 6.1 Professional baking mode

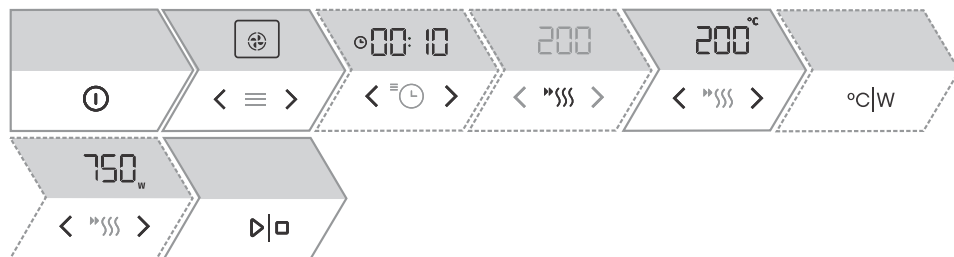

1.	Plug in the appliance. <b>Pro</b> will appear on the display unit for a few seconds. Then, the oven's default settings will appear.
2.	With the key < or > set the baking system (see table Selection of baking systems) and temperature. NOTE: If you select a system with microwaves, touch °C W and then use the < or > key to set the power level (W). Touch °C W again to set the temperature (°C).
3.	Use quick preheating to bring the oven to the desired temperature as quickly as possible. When you touch »»»» , the symbol lights up. When the set temperature is reached, an acoustic signal sounds. The display will show <b>door</b> . Open the door and insert the dish. The programme automatically resumes baking with the selected settings.
4.	Additionally, you can set: - time functions (see chapter 6.2 <i>Time functions</i> ) - baking by steps (see chapter 6.3 <i>Baking by steps</i> ) - gratin function (see chapter 7.1 <i>Additional browning – au gratin</i> )
5.	To start cooking, touch ▷ ◻ .

### Choosing the baking system

Symbol	Use
	<b>HOT AIR</b> Hot air allows for better air circulation around the dish. In this way, it dries its surface more and creates a thicker crust. For roasting meat, baking cakes and vegetables and for drying food at one or more levels at the same time.
	<b>PIZZA SYSTEM</b> This system is optimal for baking homemade pizza and pastry with higher water content. Use it to bake on a single rack, when you want the food to be done faster and to be crunchy.
	<b>AIR FRY (INTENSIVE BAKING)</b> This cooking method results in a crunchy crust without added fat. This is a healthy version of fast-food frying, resulting in lower calorie content. Suitable for smaller cuts of meat, fish, vegetables, and frozen products ready for frying (French fries, chicken nuggets).

Table continued from last page















Symbol	Use
	<p><b>GRILL WITH HOT AIR</b></p> <p>Hot air allows better flow of hot air around the food. This will dry out the surface. In combination with the grill heater/broiler, this will also result in a more intensive colour.</p> <p>For faster baking of meat and vegetables.</p>
	<p><b>TURBO BAKE</b></p> <p>For dishes where even crispiness from all sides is desirable. The system is also suitable as the first step in the step baking mode, as it allows quick browning of the surface in the first stage and slow baking in the second stage. The meat will be juicy with a nicely browned crust.</p>
	<p><b>LARGE GRILL</b></p> <p>For baking large quantities of flat foods (toasted bread, canapees, sausages for grilling, steaks, fish, skewers, etc.), for cooking au gratin and for achieving a nice crispy crust. The heaters mounted on the top of the oven cavity heat the entire surface evenly.</p> <p>Maximum permitted temperature is 240 °C.</p>
	<p><b>TOP AND BOTTOM HEATER</b></p> <p>Use this system for conventional baking on a single rack, making soufflés, and baking at low temperatures (slow cooking).</p>
	<p><b>GENTLE BAKING</b></p> <p>For gentle and controlled slow cooking of delicate food (soft cuts of meat) and baking pastry with a crunchy bottom.</p>
	<p><b>TOP AND BOTTOM HEATER WITH FAN</b></p> <p>For even baking of food on a single rack, and for making soufflés.</p>
	<p><b>LARGE GRILL WITH FAN</b></p> <p>For roasting poultry and larger cuts of meat under a broiler.</p>
	<p><b>LARGE GRILL AND BOTTOM HEATER</b></p> <p>For faster baking on a single rack and for crisply browning the top of your pastry.</p>
	<p><b>GRILL WITH BOTTOM HEATER AND FAN</b></p> <p>For optimum baking of yeast-leavened dough, all types of bread, and for preservation.</p>
	<p><b>MICROWAVES</b></p> <p>These are used for fast reheating, defrosting, and cooking of food.</p>
	<p><b>HOT AIR AND MICROWAVES</b></p> <p>In this system, the flow of hot air around the food is improved to dry out the surface and create a thicker crust. Microwaves support and speed up the cooking process. Intended for faster cooking or roasting of meat, pastry, and vegetables.</p>
	<p><b>LARGE GRILL WITH FAN AND MICROWAVES</b></p> <p>For faster roasting of poultry, fish, and larger cuts of meat under a broiler. Microwaves support and speed up the cooking process.</p>
	<p><b>CONVENTIONAL COOKING WITH FAN AND MICROWAVES</b></p> <p>For faster cooking of dishes au gratin. Microwaves support and speed up the cooking process.</p>



Table continued from last page



Symbol	Use
	<p><b>AIR FRY (INTENSIVE BAKING) WITH MICROWAVES</b></p> <p>This cooking method results in a crunchy crust, without added fat. This is a healthy version of fast-food frying, with fewer calories in the cooked food. Intended for smaller cuts of meat, fish, and vegetables.</p> <p>Microwaves support and speed up the cooking process.</p>
 <b>ECO</b>	<p><b>ECO (SLOW COOKING)</b> <sup>1)</sup></p> <p>For gentle, slow and even cooking of meat, fish and pastries on one level. This way of cooking retains a higher proportion of water in the meat, which leaves it juicier and softer, while the pastry becomes evenly browned/baked. It is used for temperatures ranging between 140 °C and 220 °C.</p>
<p>NOTE: In these systems, except for the system with microwaves and ECO, it is possible to use the gratin function (see chapter 7.1 <i>Additional browning – au gratin</i>).</p>	

<sup>1)</sup> This function is used to determine the energy efficiency class according to EN 60350-1.

### Microwave power level

Power	Use
1000 W	Quickly reheating beverages, water and dishes containing a large volume of liquid.
750 W	Cooking fresh or frozen vegetables.
600 W	Melting chocolate. Cooking meat and seafood. Cooking side dishes.
360 W	Reheating and cooking of delicate egg-based dishes.
180 W	Defrosting other food, softening butter, softening ice cream.
90 W	Defrosting cream pastry, fruit, vegetables, and ground/minced meat.

## 6.2 Time functions

Symbol	Description	Use
	<b>Baking time</b>	In this mode, you can specify the duration of operation for the oven.
	<b>Minute minder</b>	The minute minder operates independently of the oven operation. After the set time has expired, the appliance does not turn on or off automatically.
	<b>Delayed end</b>	Use this mode when you want the food in the oven to start cooking with a time delay. Enter the duration and desired end time of cooking. The appliance starts automatically and ends its operation at the desired time.

NOTE: It is not necessary to press the key to confirm the set values of the time functions.

### Setting the baking time



1. With the key < or > set the desired cooking time. The display will show ☰ .
2. To start cooking, touch ▷|□ .

### Setting the minute minder



1. When you touch ☰ , the display will show ⌚ . With the key < or > set the duration of the minute minder. Confirm the setting by touching ☰ .

The maximum possible setting is 24 hours.

NOTE: If the appliance is switched off, the minute minder will still be active.

### Setting delayed end

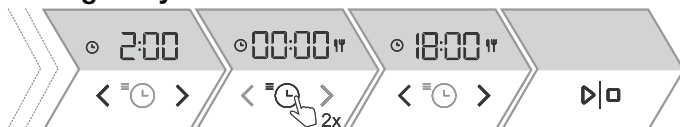

1. First set the baking time. With the key < or > set the desired cooking time. The display will show ☰ .  
*Example: cooking time 2 hours*
2. By double-tapping ☰ the display will show ⚔ .

Table continued from last page

3.	With the key < or > set the time at which you want the dish to be ready. The desired end time is shown on the display. <i>Example: cooking ends at 18:00</i>
4.	To start cooking, touch ▷ ◻ . The oven goes into partial standby while waiting to be switched on (the display goes dark). The selected settings are automatically switched on and off at the selected time. <i>Example: cooking starts at 16:00, cooking ends at 18:00</i>
Cooking end time and the clock will alternate on the display unit. After the set time has expired, the oven stops working automatically. The display will show End. An acoustic signal will be heard which you may turn off by touching any key. After one minute, the acoustic signal will be switched off automatically.	



### INFORMATION!

The selected time function can be reset to 00.00 by simultaneously touching < or > .



### WARNING!

**This function is not suitable for food that requires quick preheating. Perishable food should not be kept in the oven for a long time. Before using this mode, check whether the clock on the appliance is accurately set.**

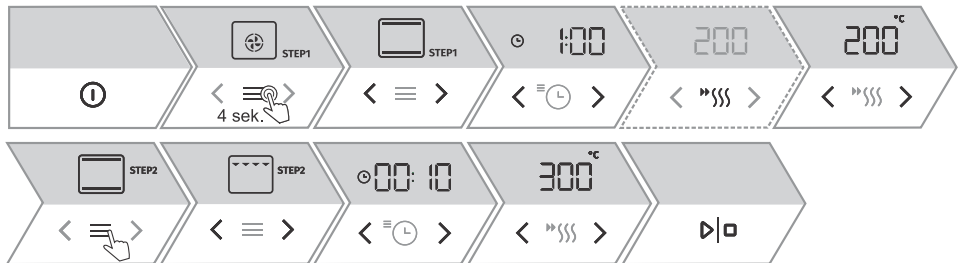

## 6.3 Baking by steps

This function allows cooking in two steps or stages (two consecutive cooking steps are combined in a single cooking process).







1.	<b>1. STEP 1</b> Turn on the oven. The display shows the default oven setting.
2.	After a long tap (4 seconds) on ≡ , the display will show <b>STEP1</b> (the first step of preparing a dish). Set the baking system, cooking time and temperature. You can also choose fast preheating.  NOTE: If you select a system with microwaves, touch °C W and then use the < or > key to set the power level (W). Touch °C W again to set the temperature (°C).
3.	<b>2. STEP 2</b> By touching again on ≡ , the display will show <b>STEP2</b> (the second step of preparing a dish; the first step has already been set).
4.	Set the baking system, cooking time and temperature.





Table continued from last page

	You can also change both steps before starting cooking. By touching  , you can go between the two steps.
5.	To start cooking, touch  . The oven first starts working with the settings for the first step.
6.	Baking by steps can be cancelled by pressing the key  for five seconds.
NOTE: If you have not set the cooking time for the steps, 00:00 flashes on the display.	

## 6.4 Automatic cooking mode



1.	Turn on the oven. The display shows the default oven setting.
2.	Touch  . For a few seconds, the display will show <b>Auto</b> , and then automatic systems will be displayed. By touching  or  , first select the system (see table below). Preset values are displayed. You can change the temperature and duration of cooking.
3.	To start cooking, touch  .
4.	Some dishes also include the quick preheating function. The sign will be fully illuminated. When the set temperature is reached, an acoustic signal will sound. The display will show <b>door</b> . Open the door and insert the dish. The programme automatically resumes baking with the selected settings.

Symbol	Use
	<b>BAKING FROZEN FOOD</b> This method allows baking frozen food in a shorter period of time without pre-heating. Optimum for pre-baked frozen products (bakery products, croissants, lasagne, French fries, chicken nuggets), meat and vegetables.
	<b>PIZZA SYSTEM</b> This system is optimal for baking homemade pizza and pastry with higher water content. Use it to bake on a single rack, when you want the food to be done faster and to be crunchy.
	<b>MEAT SYSTEM</b> For optimal meat preparation. Before baking sear the meat on all sides in a pan of hot oil. This method of preparation will preserve its juiciness. It is suitable for meat cuts such as roast beef, fillet of beef, back cuts, etc.
	<b>INTENSIVE BAKING (AIR FRY)</b> This cooking method results in a crunchy crust without added fat. This is a healthy version of fast-food frying, with fewer calories in the cooked food. Suitable for smaller cuts of meat, fish, vegetables, and frozen products ready for frying (French fries, chicken nuggets).
NOTE: For these systems it is possible to use the gratin function (see chapter 7.1 <i>Additional browning – au gratin</i> ).	

## 6.5 Automatic programs

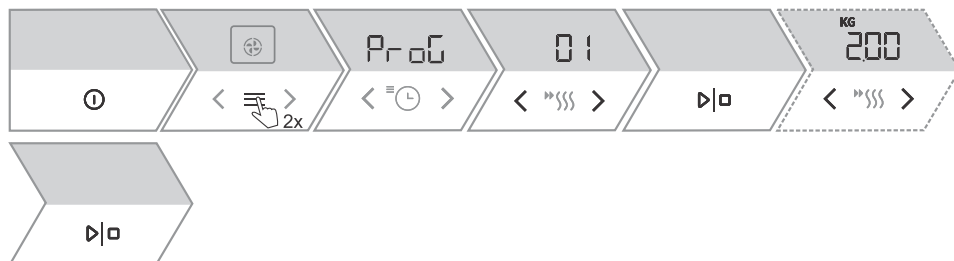

1.	Turn on the oven. The display shows the default oven setting.
2.	By double tapping ≡ , the display will briefly show <b>Prog</b> , and then automatic programmes will be displayed. By touching < or > select the programme (see table below). Confirm your selection with ▷ □ . Depending on the desired dish, the appliance will recommend the optimal heating mode, temperature and duration of cooking. Where possible, you can adjust the weight of the dish.
3.	To start cooking, touch ▷ □ .

Indication	Program name	Equipment	Level	Preheating	Turning
Pr01	<b>piped cookies</b>	shallow baking tray	2	yes	no
Pr02	<b>cupcakes</b>	shallow baking tray	2	yes	no
Pr03	<b>sponge cake</b>	baking pan/dish on wire rack	1	yes	no
Pr04	<b>yeast-leavened small pastry</b>	shallow baking tray	2	yes	no
Pr05	<b>puff pastry</b>	shallow baking tray	2	yes	no
Pr06	<b>apple pie</b>	baking pan/dish on wire rack	2	no	no
Pr07	<b>apple strudel</b>	shallow baking tray	2	no	no
Pr08	<b>chocolate soufflé</b>	baking pan/dish on wire rack	2	yes	no
Pr09	<b>rising and proofing</b>	shallow baking tray	1	no	no
Pr10	<b>bread</b>	shallow baking tray	1	no	no
Pr11	<b>pork roast</b>	small baking dish on wire rack	1	no	no
Pr12	<b>potatoes au gratin</b>	glass baking dish	1	no	no
Pr13	<b>poultry – whole</b>	wire rack with a drip tray	2	no	after 2/3 of cooking time
Pr14	<b>poultry – smaller pieces</b>	wire rack with a drip tray	2	no	after 2/3 of cooking time

Table continued from last page

Indication	Program name	Equipment	Level	Preheating	Turning
Pr15	meat loaf	baking pan/dish on wire rack	1	no	no
Pr16	oven-baked beef steak	wire rack with a drip tray	3	no	after 2/3 of cooking time
Pr17	meat – slow cooking	small baking dish on wire rack	1	yes	no
Pr18	baked/grilled fish	wire rack with a drip tray	3	no	after 2/3 of cooking time
Pr19	baked potatoes – wedges	all-purpose deep baking tray	2	no	no
Pr20	popcorn	glass baking dish	1	no	no
Pr21	lasagne	baking pan/dish on wire rack	1	no	no
Pr22	homemade pizza	shallow baking tray	1	yes	no

NOTE: The gratin function can be used with selected automatic programmes, except for Pr20 (see chapter 7.1 *Additional browning – au gratin*).



## 6.6 Additional functions



1. Turn on the oven. The display shows the default oven setting.
2. By repeatedly touching ≡, the display will briefly show **Othr**, and then additional functions will be displayed. With the key < or > select a function (see table below). Preset values are displayed. Some functions allow you to set the temperature and cooking time.
3. To start cooking, touch ▶|□.

Symbol	Use
	<p><b>Defrosting</b></p> <p>Use this function to slowly defrost frozen food (cakes, pastry, bread, rolls, and deep-frozen fruit). Preset program values may be changed (temperature, cooking duration). Halfway through the defrost time, the pieces should be turned over, stirred and separated if they were frozen together.</p>
	<p><b>Reheating</b></p> <p>This is used to keep warm the food that has already been cooked. You may set the temperature and reheating start and end time.</p>

Table continued from last page

Symbol	Use
	<b>Plate warming</b> Use this function to reheat your dinnerware (plates, cups) before serving food in it to keep the food warm longer. You may set the temperature and reheating start and end time.
	<b>Steam clean</b> This programme makes it easier to remove stains in the oven (see chapter 11.1 <i>Cleaning the oven (Steam Clean)</i> ).

## 7. Starting the cooking process



Start the cooking process by pressing .

Until the set temperature is reached, the current and the set temperature will alternate on the display unit. The temperature symbol flashes at first. When the desired temperature is reached, it goes off and an acoustic signal is emitted.

During the cooking process, you can change the system, temperature, operating power, and timer functions.

### 7.1 Additional browning – au gratin



This function is used in the last phase of cooking, when we add dressing/topping to the dish or we want to crispen its surface. When using the gratin function, a crispy golden yellow crust is formed on the dish, which protects it from drying, and at the same time gives the dish a nicer appearance and better taste.



#### **WARNING!**

**Control the cooking. When using the gratin function, the oven reaches high temperatures.**



1.	While cooking, touch  250°. Symbol <b>GRATIN</b> lights up on the display, which also shows On.
2.	<b>The function can also be switched off during operation.</b> - Touch  250°, the symbol <b>GRATIN</b> on the display will go out and the cooking will continue according to the selected settings. - Turn off the cooking by touching  .
<b>NOTE:</b> The gratin function will be active for 15 minutes at most, then the oven switches off.	

## 8. End of cooking by touching



End cooking by touching  $\triangleright|\square$ . The display shows **End** and the achieved cooking time. A short beep will be emitted.



### **INFORMATION!**

After the operation is completed, all timer settings are also stopped and deleted, except for the minute minder. Time of day (clock) will be displayed. The cooling fan will continue to operate for a while.

After the use of the oven, some water may be left in the condensate channel (underneath the door). Wipe the channel with a sponge or a cloth.



## 9. General settings





### WARNING!

After a power outage or after the appliance is switched off, additional function settings will remain stored for no more than a few minutes. Then, all settings, except for the acoustic signal volume and display dimmer will be reset to factory defaults.

1.		<p>By repeatedly touching  , the display will briefly show <b>SEtt</b>, and then the general settings menu will be displayed. You can navigate between different settings by pressing the button. &lt; or &gt; .</p>
2.		<p>The display shows <b>CLock</b>. To set the clock, first touch  . Select a 12h or 24h display and then set the time. Confirm the selection again by touching  .</p>
<p>NOTE: You can edit the individual setting by pressing &lt; or &gt; .</p>		
3.		<p><b>Acoustic signal volume</b> The display will show <b>Vol</b>. You can choose between four volume levels (zero bars – off (OFF), one, two or three bars).</p>
4.		<p><b>Display brightness</b> Select the setting <b>brht</b>. You can choose between three levels of display brightness (one, two or three bars).</p>
5.		<p><b>Display - night mode</b> It is a feature that automatically reduces display brightness during night time (between 20:00 and 6:00) and turns off the clock display as well as the acoustic signals. Select the setting <b>nGht</b>. Select power on (On) or off (OFF).</p>
6.		<p><b>Hide clock</b> It is a function that turns the clock display on or off. Select the setting <b>hidE</b>. Select power on (On) or off (OFF).</p>
7.		<p><b>Automatic quick preheating</b> The function allows quick preheating to be automatically added to cooking systems that allow for it. Select the setting <b>Auto</b>. Select power on (On) or off (OFF).</p>

Table continued from last page

8.		<p><b>Sabbath</b></p> <p>The Sabbath function allows the food in the oven to stay warm without having to turn the oven on and off.</p> <p>Select the setting SAbb.</p> <p>Set operation duration (between 24 and 72 hours) and temperature. When you touch <math>\triangleright </math>, the countdown begins.</p> <p>The display will show <b>SAbb</b>.</p> <p>All sounds and operations are switched off except for the key <math>\textcircled{1}</math>.</p> <p>NOTE: In case of a power outage, Sabbath mode will be deactivated and the oven will return to its initial state.</p>
9.		<p><b>Factory default settings</b></p> <p>This function allows the appliance to be reset to factory settings. The display will show <b>FAct</b>. Press <math>\triangleright </math> for long enough for the line under the inscription to light up completely.</p>
<p>To exit the general settings menu, touch <math>\equiv</math>.</p>		

## 9.1 Locking keys



1.	<p>With a long tap (8 seconds) on <math>\triangleright </math>, the display will show <b>Loc</b> for locking keys.</p> <p>By pressing again on <math>\triangleright </math>, you disable the lock.</p>
----	--

- If the lock is activated with no timer function engaged (only clock is displayed), then the oven will not operate.
- If the lock is activated after a timer function has been set, then the oven will operate normally; however, it will not be possible to change the settings.
- When the keys are locked, you cannot change the cooking systems or additional functions. You can only turn off the cooking.
- The keys remain locked even after the oven is switched off. To select a new system, you must deactivate the lock.

# 10. General tips and advice for baking

## Equipment:

- Use equipment made of heat-resistant non-reflective materials (supplied baking trays and dishes, enamel-coated cookware, tempered glass cookware). Bright-coloured materials (stainless steel or aluminium) materials reflect heat. As a result, thermal processing of food in them is less effective.
- Always insert the baking sheets and trays to the end of the guides. When baking on the wire rack, place the baking dishes or trays in the middle of the rack.
- Do not place the baking trays directly onto the oven cavity bottom.
- Do not use the all-purpose deep baking tray on the 1st guide level while the appliance is operating.
- Do not cover the oven cavity bottom or the wire rack with aluminium foil.
- Always place the baking dishes onto the wire rack.
- When cooking on several levels at the same time, insert the deep all-purpose baking tray into the lower level.
- If you are using parchment paper, make sure it is resistant to high-temperatures. Always trim it accordingly. Parchment paper prevents the food from sticking to the baking tray and makes it easier to remove the food from the baking tray.
- When baking directly on the wire rack, insert the all-purpose deep tray one level lower to serve as a drip tray.

## Food preparation:

- For optimum food preparation, we recommend observing the guidelines specified in the cooking table. Choose the lower specified temperature and the shortest specified cooking time. When this time expires, check the results and then adjust the settings as necessary.
- When cooking according to recipes from older cookbooks, use the bottom and top heater system (as in conventional ovens) and set the temperature 10 °C lower than specified in the recipe.
- When cooking larger cuts of meat or pastry with higher water content, a lot of steam will be generated inside the oven, which in turn may condense on the oven door. This is a normal phenomenon which will not affect the operation of the appliance. After the cooking process, wipe the door and the door glass dry.

## Efficient use of energy

- Preheat the oven only if indicated in the recipe or in the tables in this instruction manual. If you are using quick preheating, do not put food in the oven until the oven is fully heated, unless otherwise recommended. When heating an empty oven, a lot of energy is consumed, so if possible, we recommend that you prepare several dishes in a row or several dishes at the same time.
- Remove all unnecessary equipment from the oven during baking
- Unless it is absolutely necessary, do not open the oven door during baking.
- With longer cooking programs, you can switch off the oven approximately 10 minutes before the end of cooking time to make use of the accumulated heat.

## Cooking with microwaves

- Use suitable cookware (glass, ceramic etc.).
- Use cookware with a lid for cooking vegetables. Add 1 tablespoon of water per 100 g of food.
- Turn or stir the food during the defrosting process.

## 10.1 Cooking table

NOTE: Dishes requiring a fully pre-heated oven are indicated with a single asterisk \* in the table. Dishes for which a 5-minute pre-heating cycle suffices are indicated with two asterisks \*\*. In this case, do not use the rapid preheat mode.

























Dish			 °C/W	 min
<b>PASTRY AND BAKERY PRODUCTS</b>				
<b>pastry/cakes in moulds</b>				
sponge cake	1	 ECO	190-210	30-50
pie with filling	1		170-180	60-80
marble cake	1		160-170	30-40
cake with leavened dough, Gugelhupf (Bundt cake, pound cake)	1		170-180	50-60
open pie, tart	2		170-190	40-50
brownies	2		170-180 *	25-35
<b>pastry on baking trays and dishes</b>				
strudel	2		170-180	55-65
strudel, frozen	2		200-210	45-60
sponge roll	2		170-180	15-25
buchteln	1		180-190	30-40
<b>biscuits, cookies</b>				
cupcakes	2		160-170 *	20-35
cupcakes, 2 levels	2, 3		140-150 *	25-45
yeast-leavened small pastry	2		190-200	20-30
yeast-leavened small pastry, 2 levels	2, 3		170-180	20-30
puff pastry	2	 ECO	200-220	25-45
puff pastry, 2 levels	2, 3		160-170	20-30
<b>cookies/biscuits</b>				
pipéd cookies	2		140-150 *	25-40
pipéd cookies, 2 levels	2, 3		140-150 *	30-45
cookies/biscuits	2	 ECO	180-190	20-30
biscuits, 2 levels	2, 3		160-170 *	15-25

Table continued from last page





























Dish			 °C/w	 min
meringue	2		80	120-140
meringue, 2 levels	2, 3		70	120-140
macarons	2		140	13-18
macarons, 2 levels	2, 3		140	15-20
<b>bread</b>				
rising and proofing	2		35-40	30
bread on a baking tray	1		190-200	50-60
bread in a tin	1		190-200	30-45
flatbread (focaccia)	2		210-220 *	25-35
fresh bread rolls (Semmel/morning rolls)	2		190-200 *	20-30
toasted bread	4		240 *	0.5-3
open sandwiches	3		240 *	2-5
<b>pizza and other dishes</b>				
homemade pizza	1		275 *	10-17
homemade pizza, 2 rack levels	2, 3		210-220 *	30-40
frozen pizza	2		210-230	10-20
frozen pizza, 2 levels	2, 3		200-220	15-25
savoury pie, quiche	1		190-210	50-60
burek	1		180-200	30-40
<b>MEAT</b>				
<b>beef and veal</b>				
beef roast (loin, rump), 1.5 kg	1		160-180	130-160
boiled beef, 1.5 kg	1		190-210	90-110
sirloin, medium done, 1 kg	2		170-190 *	40-60
beef roast, slow cooked	1		120-140 *	250-300
beef steaks, well done, thickness 4 cm	3		200-220	25-35
burgers, thickness 3 cm	3		240	20-35
veal roast, 1.5 kg	2		180-200	100-120

Table continued from last page



























Dish			 °C/w	 min
<b>pork</b>				
pork roast, rump, 1.5 kg	1	 ECO	200-210	120-170
pork roast, shoulder, 1.5 kg	1		180-200	140-170
pork loin, 400 g	1		80-100 *	80-100
pork roast, slow cooked	1		100-120 *	200-230
pork ribs, slow cooked	1		120-140 *	210-240
pork chops, thickness 3 cm	13		220-230	20-30
<b>poultry</b>				
poultry, 1.2–2.0 kg	1		200–210/360	45-60
poultry with stuffing, 1.5 kg	1		170-190	100-120
poultry, breast	2		190-210	50-60
chicken thighs	1		190-200/600	20-30
chicken wings	2		210-220	20-35
poultry, breast, slow cooked	2		100-120 *	60-90
<b>meat dishes</b>				
meat loaf, 1 kg	2		170-190	75-90
grill sausages, bratwurst	3		230 **	8-15
<b>FISH AND SEAFOOD</b>				
whole fish, 350 g	3		230–240/360	12-17
fish fillet, thickness 1 cm	3		220-230	8-12
fish steak, thickness 2cm	3		220-230	10-15
scallops	3		230 *	5-10
shrimps	3		230 *	3-10
<b>VEGETABLES</b>				
baked potatoes, wedges	3		210-220 *	35-45
baked potatoes, halved	2		200–210/360	30-40
stuffed potato (jacket potato)	3		190-200	30-40
French fries, home-made	2		210–220/360	25-35

Table continued from last page

Dish			°C/w	min
mixed vegetables, wedges	3		190-200	30-40
stuffed vegetables	3		190-200	30-40
steamed vegetables	1		600-750	10-20
<b>CONVENTIONAL PRODUCTS – FROZEN</b>				
French fries	3		200-210	25-35
french fries, 2 levels	2, 3		200-210	35-45
chicken medallions	2		210-220 *	15-20
fish fingers	2		210-220	15-25
lasagne, 400 g	2		200-210	30-40
diced vegetables	2		190-200	20-30
croissants	2		170-180	18-23
<b>BAKED PUDDINGS, SOUFFLÉS AND DISHES AU GRATIN</b>				
potato moussaka	1		200–210/360	35-45
lasagne	1		200–210/360	35-45
sweet baked pudding	1		750	15-25
sweet soufflé	2		180 *	15-20
dishes au gratin	2		170-190	30-45
stuffed tortillas, enchiladas	2		180-200	20-35
grilling cheese	3		240 **	6-9
<b>OTHER</b>				
popcorn	1		1000	3-4
preservation	2		180	30
sterilization	2		1000	2
cooking in a bain-marie (double boiler)	1		150-170 *	/
reheating	1		600	/
plate warming	2		75	15
defrosting	1		90-180	/

# 11. Cleaning and maintenance



## WARNING!

Be sure to unplug the appliance from the power supply and wait for the appliance to cool down.

Children should not clean the appliance or perform maintenance tasks without proper supervision.

Appliance door is attached to the appliance and may not be removed. Also, the door may not be disassembled or otherwise tampered with.

- For easier cleaning, oven cavity and baking tray are coated with special enamel for a smooth and resistant surface.
- Regularly clean the appliance and use warm water and hand dishwashing liquid to remove larger impurities and limescale. Use a clean soft cloth or sponge cloth.
- Never use aggressive or abrasive cleaners and accessories (abrasive sponges and detergents, stain and rust removers, scrapers for glass ceramic plates).
- Food residue (fat, sugar, protein) can ignite during the use of the appliance. Therefore, remove larger chunks of dirt from the oven interior and accessories before each use.
- Oven equipment is dishwasher-safe.

<b>Exterior of the appliance</b>	Use hot soapy water and a soft cloth to remove impurities and wipe the surfaces dry.
<b>Interior of the appliance</b>	For stubborn dirt or grime, use conventional oven cleaners. After using such agents, wipe the appliance thoroughly with a wet cloth to remove any residual cleaning agents.
<b>Utensils and guides</b>	Clean with hot soapy water and a damp cloth. In case of persistent dirt, we recommend prior soaking and the use of a brush.
If the cleaning results are not satisfactory, repeat the cleaning process.	

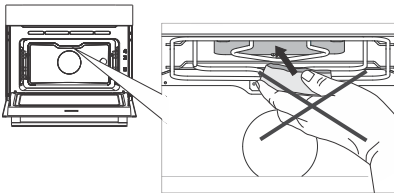

Never use aggressive cleaners, abrasive cleaners or sponges, stain and rust removers etc. on the oven cavity ceiling cover.



## 11.1 Cleaning the oven (Steam Clean)

This program makes it easier to remove any stains from inside the oven.





The function is the most effective if used regularly, after each use.

Before running the cleaning program, remove all large visible chunks of dirt and food residues from the oven cavity.

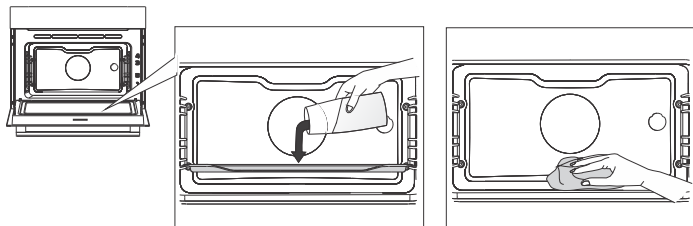
### **WARNING!**

Use the Steam Clean system when the oven has fully cooled down.



1.	Insert the glass baking tray into the first guide level and pour 0.4 l of warm water into it.
2.	Turn on the oven. By repeatedly touching  , additional features will appear on the display. With  or  select the function  . Preset values are displayed.
3.	The program will operate for 8 minutes. When the program is complete, <b>End</b> will appear on the display unit.
4.	When the program is completed, carefully remove the baking tray, using oven mitts (there can still be some water on the baking tray). Wipe down the stains with damp cloth and soapsuds. Thoroughly wipe the appliance with a wet cloth to remove all cleaner residue. If the cleaning process is not successful (in case of particularly stubborn dirt), repeat it.

## 11.2 Removing and cleaning the wire guides

### **INFORMATION!**

When removing the guides, take care not to damage the enamel coating.

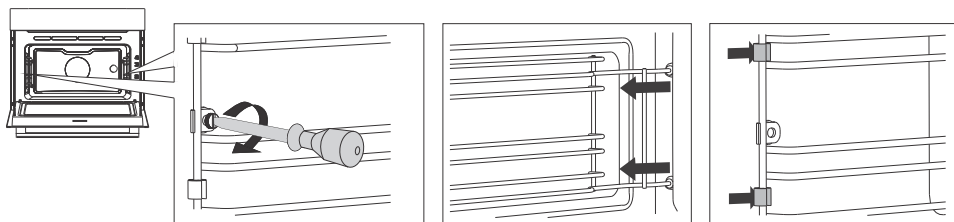

1.	Undo the screw. Use a screwdriver.
2.	Remove the guides from the holes in the back wall.
<b>NOTE:</b> Take care not to lose the spacers fitted on the wire guides. Replace the spacers after cleaning; otherwise, sparks may appear.	



**WARNING!**

After cleaning, re-tighten the screws on the guides with a screwdriver.

When replacing the wire guides, make sure you mount them on the same side they were installed on prior to removal.

## 11.3 Replacing the bulb

The light bulb is a consumable and is not covered by warranty. Before changing the bulb, remove any utensils from the oven.

Halogen lamp: G9, 230 V, 25 W

The oven is fitted with a halogen lamp.

This product contains a light source of energy efficiency class (G).

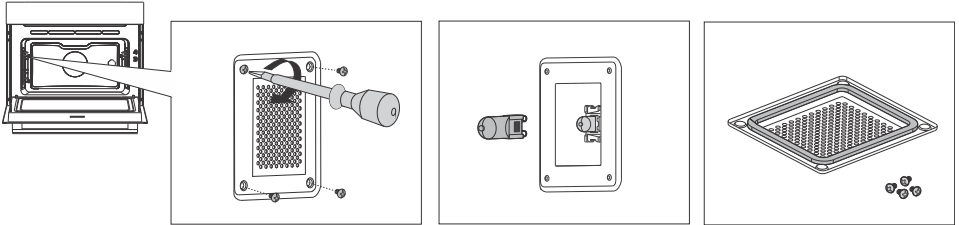

1.	Undo the four screws. Remove the cover and the glass.
2.	Remove the halogen light bulb and replace it with a new one.
NOTE: Use protection to avoid burns. There is a gasket on the cover which should not be removed. The gasket should fit onto the oven cavity wall.	

# 12. Troubleshooting

**During the warranty period, only a service center authorized by the manufacturer may carry out any repairs.**

- Before making any repairs, make sure the appliance is disconnected from the power mains either by removing the fuse or by disconnecting the power plug from the wall outlet.
- Any unauthorized repairs of the appliance may result in electric shock and short circuit hazard; therefore, do not perform them. Leave such work to an expert or a service technician.
- In case of minor problems with appliance operation, check this manual to see if you can fix the problem yourself.
- If the appliance is not operating properly or at all due to inappropriate operation or handling, a visit from a service technician shall not be free of charge, even during the warranty period.
- Save the instructions for future reference and pass them on to any subsequent owners or users of the appliance.
- Following is some advice on rectifying some common problems.

## 12.1 Troubleshooting table

Problem/error	Cause
<b>The main fuse in your home trips often.</b>	Call a service technician.
<b>The oven lighting does not work.</b>	The process of changing the light bulb in the oven is described in the chapter Replacing the bulb.
<b>Control unit is not responding, the screen is frozen.</b>	Disconnect the appliance from the power mains for a few minutes (undo the fuse or switch off the main switch); then, reconnect the appliance and switch it on.
<b>Error code ErrX is displayed. In case of a double-digit error code, the display will show ErXX.</b>	There is an error in the electronic module operation. Disconnect the appliance from the power mains for a few minutes. If the error is still indicated, call a service technician.
<b>Sparks appear in the oven</b>	Make sure all lamp covers are securely fastened and that all spacers are fitted on the wire guides. Make sure the guides in the oven are correctly placed.

If the problems persist despite observing the above advice, call an authorized service technician. Repair or any warranty claim resulting from incorrect connection or use of the appliance shall not be covered by the warranty. In this case, the user will cover the cost of repair.

## 12.2 Label – appliance information

A rating plate with basic information about the appliance is attached to the edge of the oven. Precise information on appliance type and model can also be found on the warranty sheet.

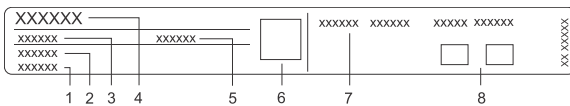

- 1 Serial number
- 2 Model
- 3 Type
- 4 Brand

- 5 Code/ID
- 6 QR code (depending on the model)
- 7 Technical information
- 8 Compliance indications/symbols

# 13. Cooking test

EN60350-1: Only use equipment supplied by the manufacturer.

Always insert the baking tray all the way to the end position on the wire guide. Place pastry or cakes baked in moulds as shown in the image.

\* Preheat the appliance until it reaches the set temperature. Do not use the rapid preheat mode.

\*\* Preheat the appliance for 10 minutes. Do not use the rapid preheat mode.

\*\*\* Turn after 2/3 of cooking time.



























BAKING					
Dish	Equipment		 °C	 min	
biscuits/cookies – single rack	shallow baking tray	2	140-150*	25-40	
biscuits/cookies – single rack	shallow baking tray	2	140-150*	25-40	
cookies – two racks/levels	shallow baking tray	2, 3	140-150*	30-45	
cupcakes – single rack	shallow baking tray	2	160-170*	20-35	
cupcakes – single rack	shallow baking tray	2	160-170*	20-35	
cupcakes – two racks/levels	shallow baking tray	2, 3	140-150*	25-40	
sponge cake	round metal mould, diameter 26 cm/wire rack	1	160-170*	20-35	
sponge cake	round metal mould, diameter 26 cm/wire rack	2	160-170*	20-35	
apple pie	2 × round metal mould, diameter 20cm/wire rack	1	170-180	60-80	
apple pie	2 × round metal mould, diameter 20cm/wire rack	2	170-180	60-80	
BROILING					
toasted bread	wire rack	4	240**	0.5–3	
pljeskavica (minced meat patty)	wire rack + shallow baking sheet as drip tray	3	240	20-35***	
THERMAL PROCESSING WITH MICROWAVES					
custard cream, 1000 g	glass baking dish, 25 × 25 cm, uncovered + glass baking tray	1	360	25-35	
sponge cake	round glass baking dish, diameter 22 cm, uncovered + glass baking tray	1	360	15-25	
meat loaf, 900 g	glass baking dish, 25 × 12.5 cm, uncovered + glass baking tray	1	600 360	10 10-15	

Table continued from last page

<b>BAKING</b>						
defrosting ground meat, 500 g	glass baking tray	1	180 90	8 13-18		
defrosting raspberries, 250 g	glass baking dish, uncovered + glass baking tray	1	180	6-9		

<b>BAKING WITH COMBINED SYSTEMS</b>						
Dish	Equipment		°C	~ ~ W	⌚ min	
potatoes au gratin	round glass baking dish, diameter 22 cm, uncovered + glass baking tray	1	180-190	600	25-40	
cake	round glass baking dish, diameter 22 cm, uncovered + glass baking tray	1	180-190	180	17-25	
chicken, 1.2 kg	glass baking dish, uncovered + glass baking tray	1	210-220	360	45-55	

**Hisense**  
life reimagined



901191-a2

