



## Technical specification

Product title	CUGGL ISIZE INFANT CARRIER & BASE
Argos Cat. No.	3288908
Supplier Ref. No.	98515
Height group	40cm - 87cm
Safety compliance	Car seat complies with ECE R129
Product weight	Infant Carrier 4.5kg / Base 4.8kg
Product unfolded size	L72.4 x W44 x H38.5cm

**If you encounter any problems  
with this product please call  
our customer care team on  
0345 640 2020**

Made in China,  
Argos Limited London , EC1N 2HT  
Argos (N.I.) Ltd, Forestside Shopping Centre,  
Upper Galwally, Belfast, United Kingdom, BT8 6FX

Cat No: 3288908

-21-



## CUGGL ISIZE INFANT CARRIER & BASE

For infants of height ranges from 40cm to 87cm  
care & instruction manual

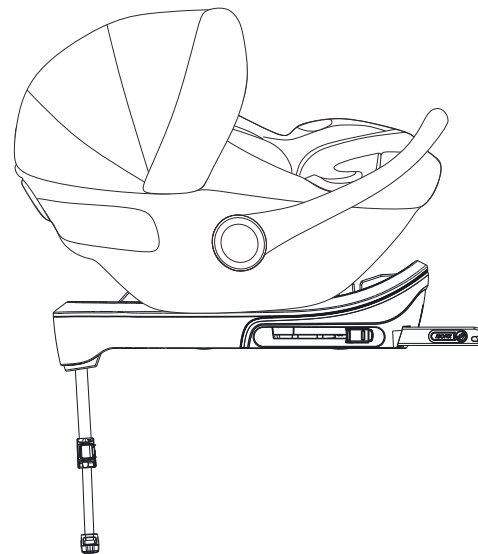

**IMPORTANT, RETAIN FOR FUTURE  
REFERENCE: READ CAREFULLY**



## **IMPORTANT, RETAIN FOR FUTURE REFERENCE: READ CAREFULLY**

This is an i-Size Enhanced Child Restraint System. It is approved according to UN Regulation No.129, for use in i-Size compatible vehicle seating positions as indicated by vehicle manufacturers in the vehicle users' manual.

If in doubt, consult either the Enhanced Child Restraint System manufacturer or the retailer.

Do not use the ECRS in seating positions where there is an active frontal airbag installed.

### **WARNING**

- The rigid items and plastic parts of an Enhanced Child Restraint System shall be so located and installed that they are not liable, during everyday use of the vehicle, to become trapped by a movable seat or in a door of the vehicle.
- Do use carry-cots perpendicular to the longitudinal axis of the vehicle.
- Any straps holding the restraint to the vehicle should be tight, any support-leg should be in contact with the vehicle floor, any straps or impact shields restraining the child should be adjusted to the child's body and straps should not be twisted.
- It is important to ensure that any lap strap is worn low down.
- The Enhanced Child Restraint System should be replaced when it has been subject to violent stresses in an accident.
- It is dangerous to make any alterations or additions to the device without the approval of the Type Approval Authority, and it is also dangerous if you do not follow closely the installation instructions provided by the Enhanced Child Restraint System manufacturer.
- Be sure that children are not left in their ECRS unattended.

Cat No: 3288908



- Be sure that any luggage or other objects liable to cause injuries in the event of a collision are properly secured in the vehicle.
- Be sure that the Enhanced Child Restraint System shall not be used without the cover.
- Be sure that the Enhanced Child Restraint System cover is not replaced with any other than the one recommended by the manufacturer because the cover constitutes an integral part of the restraint performance.
- Refer to the vehicle manufacturer's handbook for the use of an "i-Size ECRS".

**WARNING!** Do not allow food or drink in or near the car seat as debris and dirt ingress can affect the critical safety performance of the harness system.

**WARNING!** Do not install the car seat if there is a storage compartment below the support leg.

Cat No: 3288908



## Know your car seat

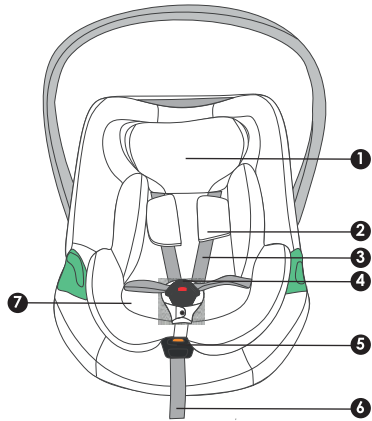

1. Headrest
2. Shoulder pad
3. Shoulder strap
4. Harness buckle
5. Harness release button
6. Harness strap
7. Baby insert

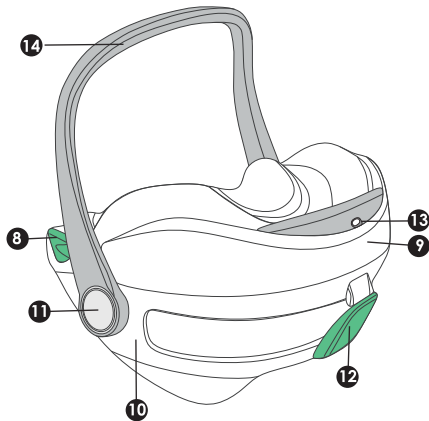

8. Lap belt guide
9. Sun shade cover
10. Seat shell
11. Handle adjuster
12. Diagonal belt guide
13. Headrest adjuster
14. Handle

Cat No: 3288908



## Know your ISOFIX base

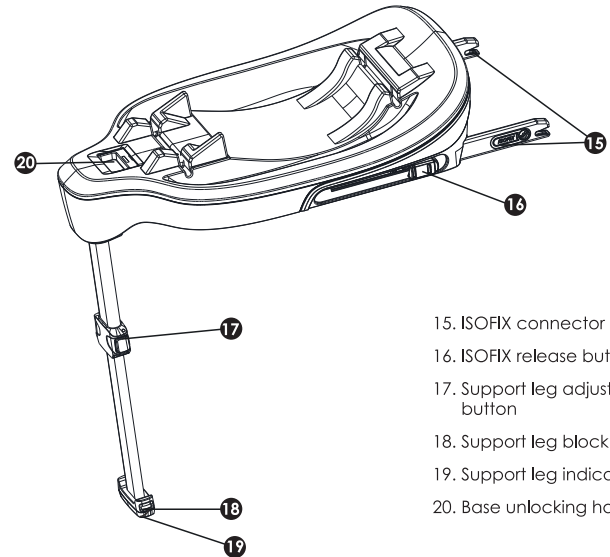

15. ISOFIX connector
16. ISOFIX release button
17. Support leg adjusting button
18. Support leg block
19. Support leg indicator
20. Base unlocking handle

Cat No: 3288908



## Use in the vehicle

### Certification

Cuggl iSize Isofix base Child Safety Seat	Tested and certified according to ECE*R129	
	<b>Applicable size range</b>	<b>Body weight</b>
Cuggl iSize Isofix base	Height from 40cm to 87cm	Up to 13kg

\*ECE = European Standard for Safety Equipment

The child safety seat has been designed, tested and certified according to the requirements of the European Standard for Child Safety Equipment (ECE R 129).

The seal of approval E (in a circle) and the approval number are located on the approval label (sticker on the child safety seat).

This approval will be invalidated if you make any modifications to the child safety seat.

Only the manufacturer is permitted to make modifications to the child safety seat.

### 2. Use in the vehicle

#### WARNING

Never use this child restraint system in seating positions where an active airbag is installed. An active frontal airbag may cause death or seriously injury of your child in an accident. Please read the instructions carefully and keep safely for future reference.

There is an instructions compartment in the back of the child car seat for storage of the instructions manual.



Cat No: 3288908



You can use your child car seat as follows:



## Securing your baby

### 3. Securing your baby

#### 3.1 Using the baby insert

#### For the protection of your baby

The baby insert gives your baby the necessary support while he or she is still small. The baby insert is used to provide extra comfort for very small babies.

Caution! Please use the baby insert attached to this infant carrier when your baby's height is less than 75cm

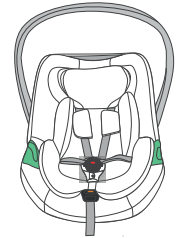

- Always secure your baby in the infant carrier using the harness.
- Never leave your baby unattended in the infant carrier when placing it on elevated surfaces (e.g. a table, nappy changing unit, etc.).
- Never allow the strap end to become caught in moving parts (e.g. automatic doors, escalators, etc.).
- Caution! The plastic parts of the infant carrier heat up in the sun, be aware that your baby may get burnt. Protect your baby and the infant carrier against intensive solar radiation (e.g. by putting a light cloth over the seat).
- The infant carrier requires only one seating position in the car. This advantage means, however, that your baby must be in a semi-reclined position.
- Take your baby out of the infant carrier as often as possible to relieve its spine. We recommend frequent breaks during long journeys. Even outside of the car, please avoid leaving your baby in the infant carrier for too long.

Cat No: 3288908

## Adjusting the handle

### 1 You can engage the handle in four positions

Simultaneously press both buttons on the handle.

Then whilst holding the adjuster pressed turn the handle backwards until it engages in the desired position.

**A:** Only use for carrying, can not be in this position when installing in the vehicle seat. Caution! Ensure that the handle is securely engaged before you pick up the infant carrier.

**B:** For placing your baby into the infant carrier.

**C:** For setting the infant carrier down safely outside the car.

**D:** Should be used when installed on the vehicle seat.

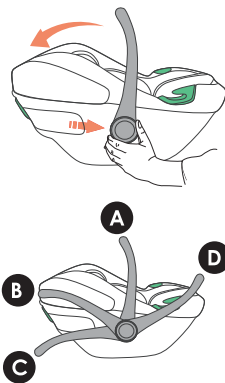

## Adjusting the headrest

**1** A correctly adjusted headrest ensures your baby's optimal posture in the infant carrier. The headrest must be adjusted so that the shoulder straps are at the same level as your baby's shoulders or slightly above.

### To adjust the height of the headrest to fit your baby:

Tilt the headrest adjuster until it disengages. Slide the headrest adjuster until the shoulder straps are at the correct height and re-engage.

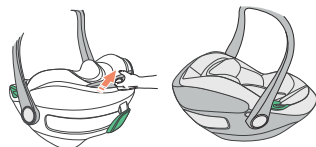

Cat No: 3288908

## Loosening the shoulder straps

**1** Press the harness release button and at the same time pull both shoulder straps forward.

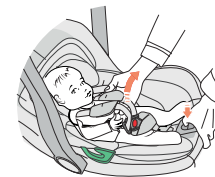

## Securing your baby using the harness

Installation instructions for child of height 76-105cm, forward facing, ISOFIX + Top Tether + harness

**1**

- Loosen the shoulder straps.
- Open the harness buckle (press the red release button).

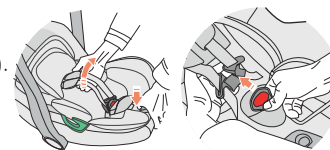

**2**

- Place your baby into the infant carrier.
- Put the shoulder straps over the shoulders of your baby, then put the buckle tongues together and engage in the harness buckle with an audible "click".

**Caution!** Do not twist or interchange the shoulder straps.

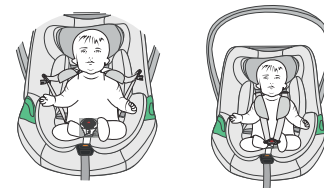

Cat No: 3288908

### 3 Tightening the harness

Pull the strap end.  
Caution! Pull the strap end straight towards you, not upwards or downwards.  
Please pay attention to the strap end whilst travelling (especially outside the car) it should always be attached to the cover.

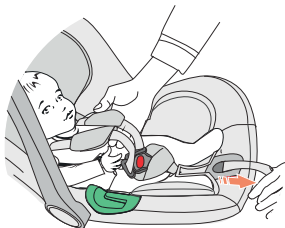

#### Checklist to ensure that your baby is buckle up correctly

##### For the safety of your baby, please check that...

- The shoulder straps of the infant carrier are comfortable but are a FIRM fit around your child.
- The shoulder straps are adjusted correctly.
- The shoulder straps are not twisted.
- The buckle tongues are engaged in the harness buckle.

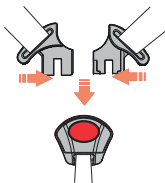

## Installation in the vehicle

 Please do not leave your child unattended in the child safety seat in the vehicle.

 For the protection of all vehicle occupants

In the case of an emergency stop or an accident unsecured persons or objects may cause injury to other vehicle occupants. Please always check that ...

- The backrests of the vehicle seats are locked (i.e. that a foldable rear seat bench latch is engaged).
- All heavy or sharp-edged objects in the vehicle (e.g. on the parcel shelf) are secured.
- All persons in the vehicle have their seat belts fastened.
- The child safety seat is always secured when it is in the vehicle, even if no child is being transported.

#### To protect your vehicle

Some vehicle seat covers of sensitive materials (e.g. velour, leather, etc.) may develop wear marks when child seats are used. This can be avoided by placing a blanket or towel under the child seat.

 The baby insert is only suitable for infants with height form 40 to 75CM . if your child has height more than 75cm please take out the baby insert .

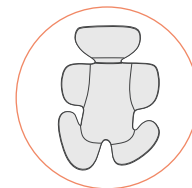

## Installation in the vehicle

Installation instruction for STATURE 40- 87 cm, Rearward facing, ISOFIX + Support Leg+ harness.

### 1 ISOFIX locator guides

The ISOFIX insertion guides enable you to easily install an ISOFIX car seat in your car. They are attached to the ISOFIX attachment points in the vehicle and keep the vehicle's back and seat cushion apart so you can easily attach the ISOFIX arms even if the attachment points in the car are difficult to reach.

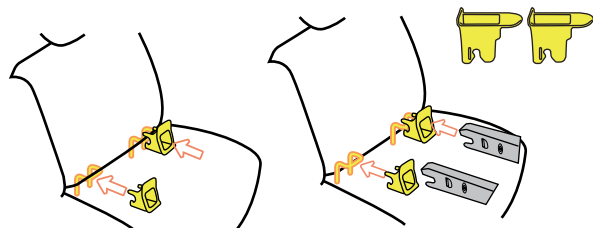

2 First install the base on the seat, then put the infant carrier onto it. Unfold support leg until it locks in place. Press the ISOFIX release button to slide the ISOFIX connectors to the end.

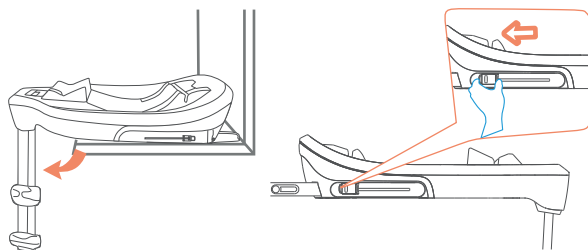

Cat No: 3288908

3 **Caution:** Please only move to next step when ISOFIX has been slid to the end with the red indicators showing.

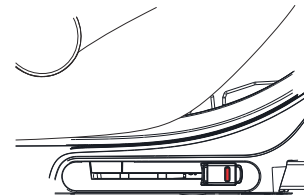

4 Push the ISOFIX connectors directly into the anchorages until you hear an audible "click" sound. Grasp the seat base to check if the seat is fastened tightly or shakes, meanwhile observe the ISOFIX red/green indicator. If the seat shakes and the ISOFIX connectors are pulled out, please repeat the above steps and install it again.

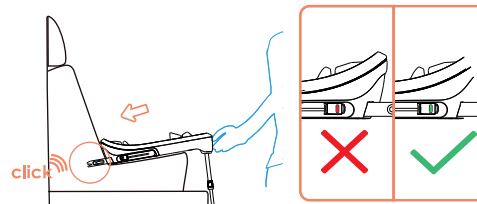

5 Squeeze the support leg adjusting button, pull out the support leg until it rests firmly on the floor. Observe the ISOFIX red/green indicator to confirm the installation status.

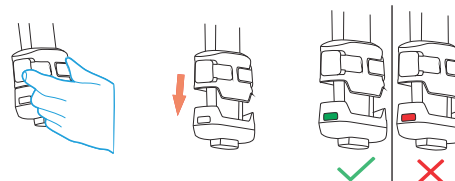

Cat No: 3288908

cuggl 

**⚠ WARNING!**  
Do not install the car seat if there is a storage compartment below the support leg.

**6** Match the infant carrier with the base, press the front and end of it until there are two "click" sounds. Make sure it is connected correctly by gently shaking and lifting the infant carrier. And ensure that the handle is in its upper position D.

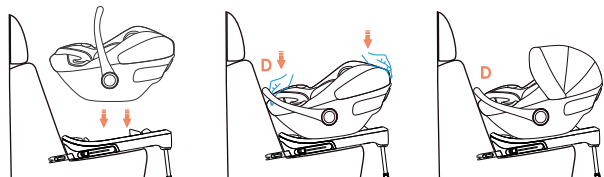

**7** **Removing the Infant Carrier and base**  
First remove the infant carrier from the base, then remove the base from the vehicle.

To remove the infant carrier from the base squeeze the release handle on the top front of the base to release the infant carrier. Then simply lift the infant carrier up off the base.

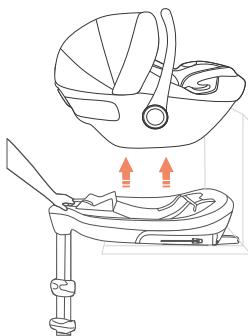

Cat No: 3288908

-14-

cuggl 

**8** To remove the base from the vehicle, squeeze the 2 release buttons either side of the base to release the isofix connectors from the vehicle's seat.

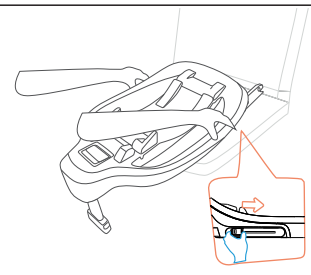

**9** Squeeze the support leg adjusting button to retract the support leg.

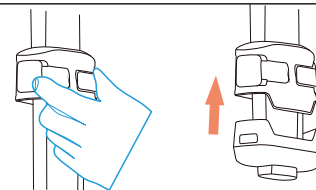

**10** The base is now ready to be removed from the vehicle.

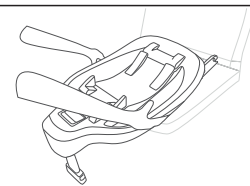

**11** Finally, rotate the support leg and insert it into the slot at the bottom of the seat

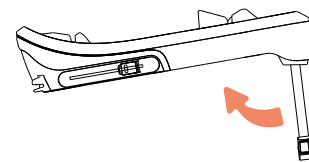

Cat No: 3288908

-15-



## Installation in the vehicle

Installation in the vehicle using the vehicle's seat belt  
(Not using the Isofix base)

**1** To secure the infant carrier using the 3-point belt of your vehicle proceed as follows:

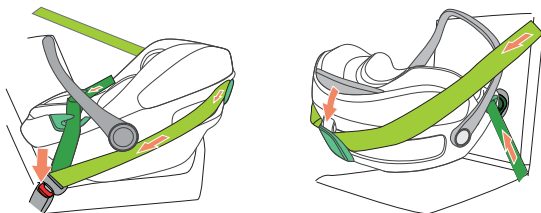

Place the infant carrier rearward facing on the vehicle seat (baby is facing backwards).

In certain cases it is possible that the infant carrier does not rest securely or is inclined too steeply on the vehicle seat.

Ensure that the handle is in its upper position D.

Pull out the vehicle seat belt and place it across the infant carrier. Engage the buckle tongue in the vehicle seat buckle.

Place the lap belt section in the green belt guides on both sides of the infant carrier.

**Caution!** Do not twist the belt.

Tighten the lap belt section by pulling the diagonal belt section.

Pull the diagonal seat belt section behind the top end of the infant carrier.

**Caution!** Do not twist the belt.

**!** For the safety of your baby, please check that:

- The infant carrier is installed rearward facing.
- The infant carrier is only installed on the front passenger seat if no front airbag can strike the infant carrier.
- The infant carrier is only secured using a 3-point belt.
- The lap belt section runs through both green belt guides on the infant carrier.
- The diagonal belt section runs through the light green belt guides on the infant carrier.
- The vehicle seat belt is tightened up and not twisted.

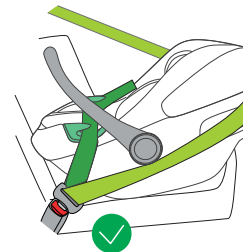

## Fitting the sunshade

**1** Pull the head plate to expand/Fold the canopy.

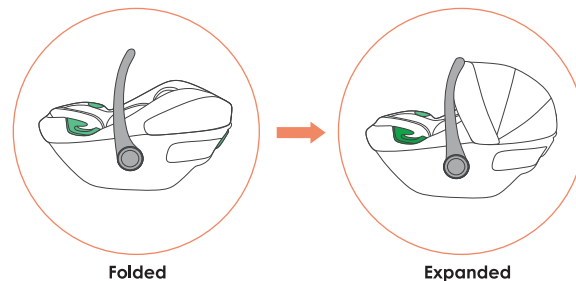

Folded

Expanded

## PRODUCT CARE

### Follow these instructions for protective product care

- In an accident at a collision speed above 10 km/h the child safety seat could suffer damage which is not necessarily obvious.
- In such cases it is extremely important that you replace the child seat. Please dispose of it properly.
- Regularly check all important parts for damage.
- Ensure the correct operation of all mechanical components.
- To prevent damage or breakage, ensure that the child seat does not become jammed in the car door, seat runners, etc.
- Should the child seat be damaged (for example after dropping it) it must be inspected by the manufacturer.

### Care for the harness buckle

The function of the harness buckle is important for the safety of your child. Malfunctions of the harness buckle are mostly attributable to accumulations of dirt and dust.

## Removing the fabrics to clean

1

Undo the button on the side part of the cover.

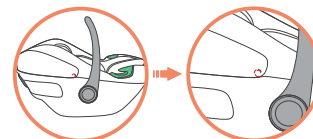

Undo button on the main cover.

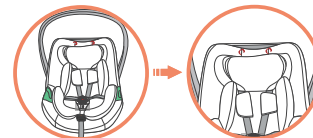

Press the harness release button and at the same time pull both shoulder straps forward.

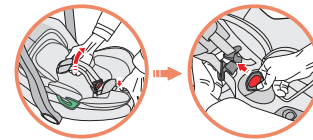

Undo the button on the main cover and the should pad.

Take off the fabric cover and wash it.

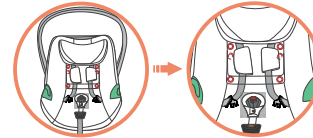

### Refitting the fabric cover

To refit the cover on the seat just hook up the elastic loops to the hooks and fit back the headrest cover.



## CLEANING

Please be sure to use only original Cuggl replacement seat covers, as the seat cover is important to the proper functioning of the system. Replacement seat covers are available from Argos.

**⚠ The child seat must not be used without the seat cover.**

- The cover can be removed and hand washed at 30°C with a mild detergent. Please observe the instructions on the washing label of the cover. The colours of the cover may fade if washed at more than 30°C. Never tumble dry in an electric clothes dryer (the fabric may separate from the padding).
- The plastic parts can be cleaned using soapy water. Do not use harsh cleaning agents (such as solvents).
- The harness can be removed and washed in lukewarm soapy water.

**Caution!** Never remove the buckle tongues from the straps.