



## Spare Parts

 [www.argos-support.co.uk](http://www.argos-support.co.uk)

 [Help@ClickSpares.co.uk](mailto:Help@ClickSpares.co.uk)

 0370 112 1928

## Customer Support

 0345 640 2020



# Safety and Care Advice

---

## Product Details

3208115, 4634946 (bookstand)

## IMPORTANT, RETAIN FOR FUTURE REFERENCE: READ CAREFULLY.

- Keep children and animals away from the work area, small parts could choke if swallowed.
- Assemble the item as close to its final position (in the same room) as possible.
- Assemble on a soft level surface to avoid damaging the unit or your floor.
- We do not recommend the use of power drill/drivers for inserting screws as this could damage the unit. Only use hand screwdrivers.
- Parts of the assembly will be easier with 2 people.
- Dispose of all packaging carefully and responsibly.

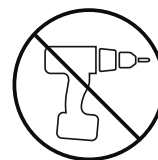

## Care and maintenance

---

- Only clean using a damp cloth and mild detergent. Do not use abrasive cleaners.
- From time to time check that there are no loose screws, nuts or bolts. If there are please re-tighten.
- This product should not be discarded with household waste. Take to your local authority waste disposal centre.
- Use a dry cloth to clean the product, furniture polish is not recommended.

## Additional Guidance

---

- Assemble all parts and bolts loosely during assembly, only once the product is complete should you fully tighten the bolts.
- Regularly check and ensure that all bolts and fittings are tightend properly.
- Maximum user weight 25kg
- This product is compliant BS 4875-7; EN 14749

### ANTI-TOPPLE WARNING!

This product has to be permanently fixed to the wall with the bracket(s) included, to avoid fatal injury in case it topples over. The pack only contains screws for fastening the anti-topple bracket(s) itself to the product. Please contact your DIY or hardware store for advice on the correct type of screws/raw plugs for your type of wall.

Sainsbury's Argos is a trading name of both: Argos Limited, Registered office: 489-499 Avebury Boulevard, Milton Keynes, United Kingdom, MK9 2NW, registered number: 01081551 (England and Wales); and Sainsbury's Supermarkets Limited, Registered office: 33 Holborn, London, EC1N 2HT, registered number: 03261722 (England and Wales). Both companies are subsidiaries of J Sainsbury's plc.

# Fittings (Shown to scale)

## Bag 1



**A**  
ø8x35 wooden dowel x 16



**B**  
ø8x60 wooden dowel x 2

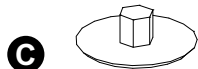

**C**  
cam lock cap x 14



**D**  
Cam lock x14



**E**  
Metal Cam Screw x 10



**F**  
ø7x82 mm Metal Cam Screw dual x 2

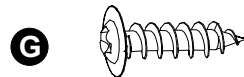

**G**  
ø3,5x16 mm screw x 8



**H**  
ø4x16 mm screw x 2

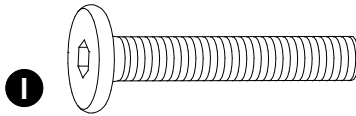

**I**  
ø6xM35 mm screw x 4



**J**  
ø20 felt pad x 4

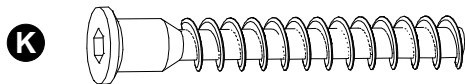

**K**  
ø7x50 mm hexagon bolt x 6



**L**  
Allen Key x 1

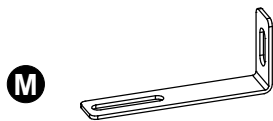

**M**  
Wall bracket 78x32mm x 2

# Hardware

---

**N**

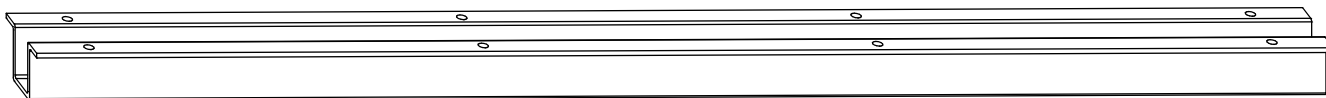

L-526 mm Stiffening profile x1

**O**



H-150 mm Wooden leg x4

**P**

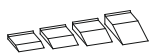

Height adjuster wedges set x 1

# Tools required

---

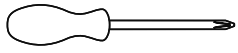

Phillips screwdriver  
(small & medium)

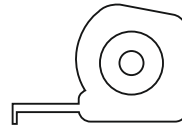

Ruler/tape  
measure

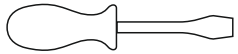

Phillips screwdriver  
(small & medium)

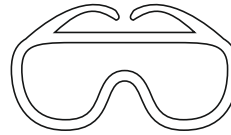

Eye protection  
(when using a  
hammer or glue)

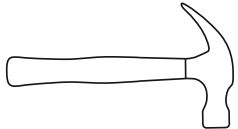

Large hammer

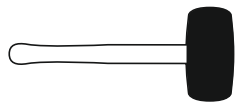

Mallet

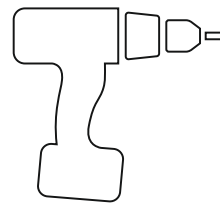

Power Drill

# Panels

---

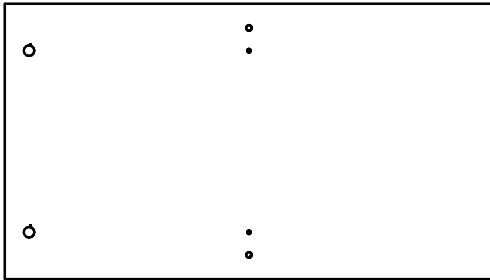

**3** Side panel (L/R) x 2 (69x39cm)

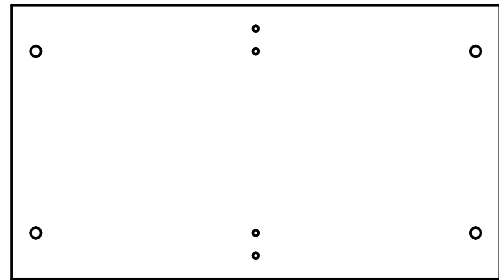

**6** Horizontal partition x 1 (69x39cm)

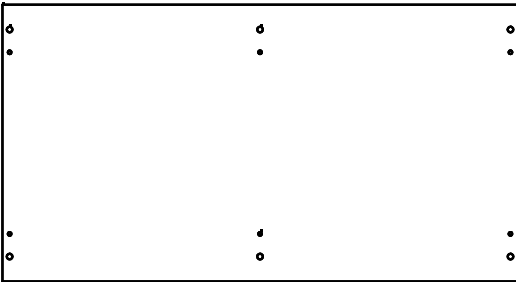

**1** Top panel x 1 (73x39cm)

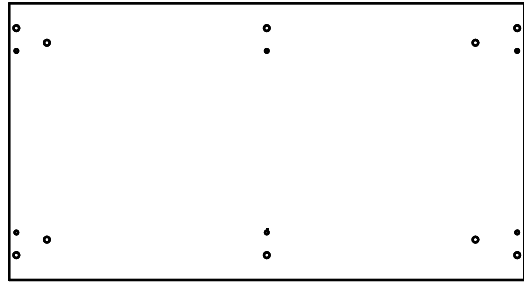

**2** Bottom panel x 1 (73x39cm)

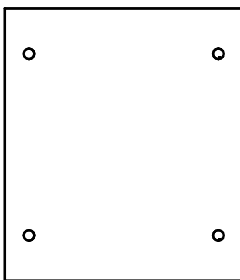

**4** Upper Vertical partition x 1 (34x38cm)

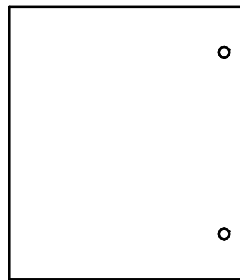

**5** Bottom Vertical partition x 1 (34x38cm)

# 1

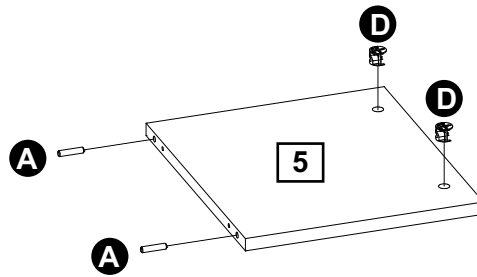
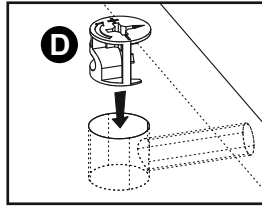
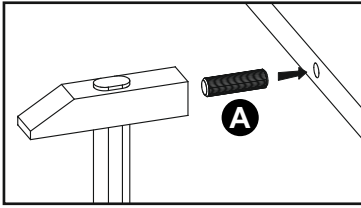
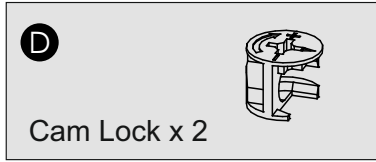
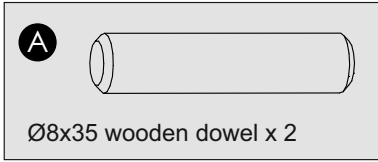

# 2

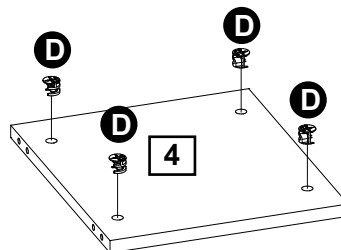
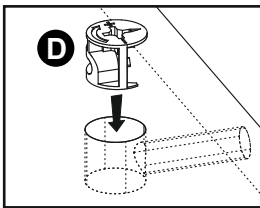
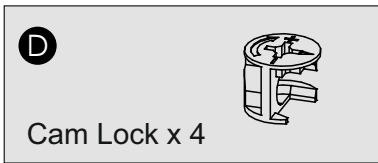

# 3

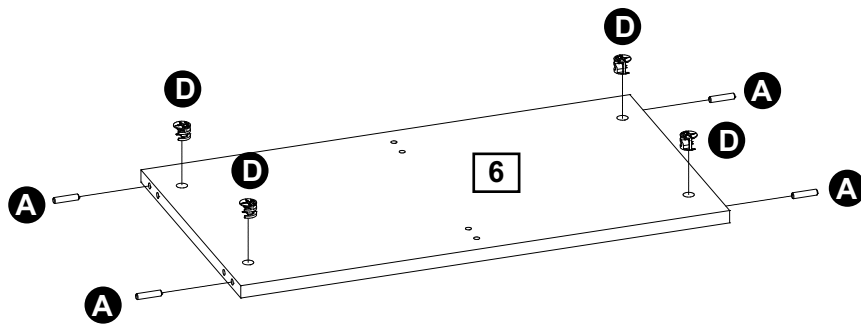
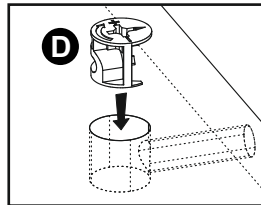
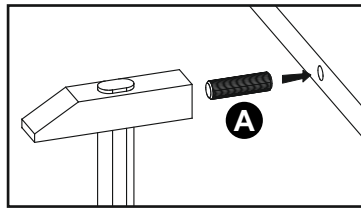
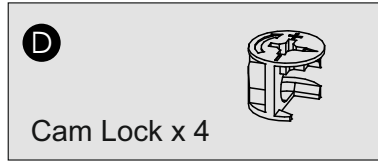
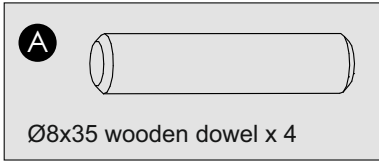



# 4

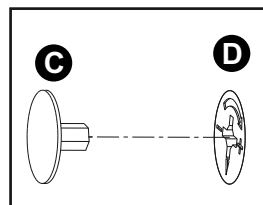
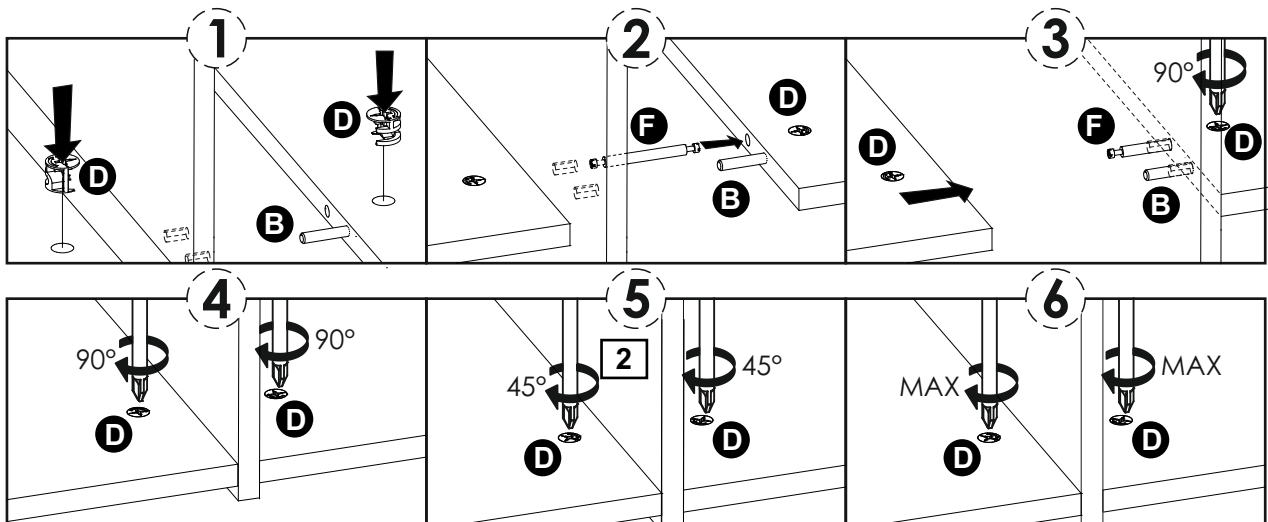
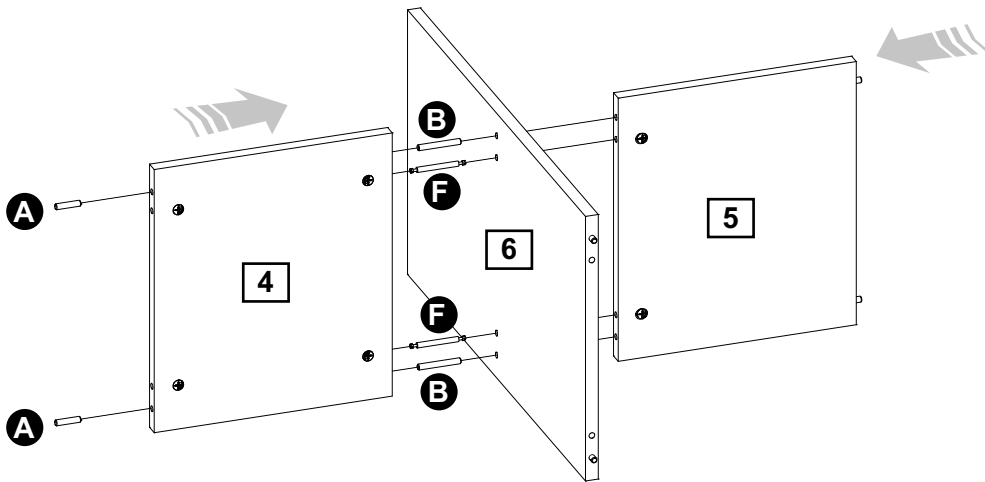
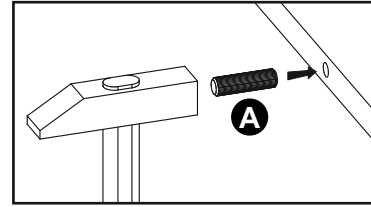
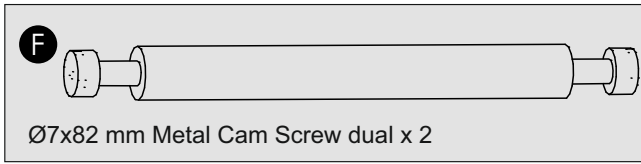
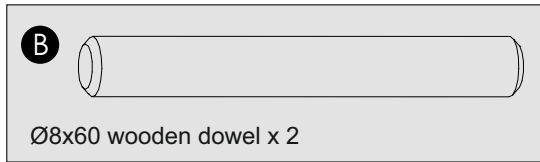
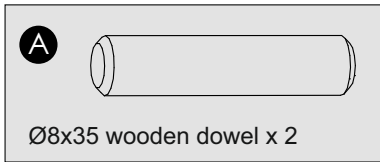

# 5

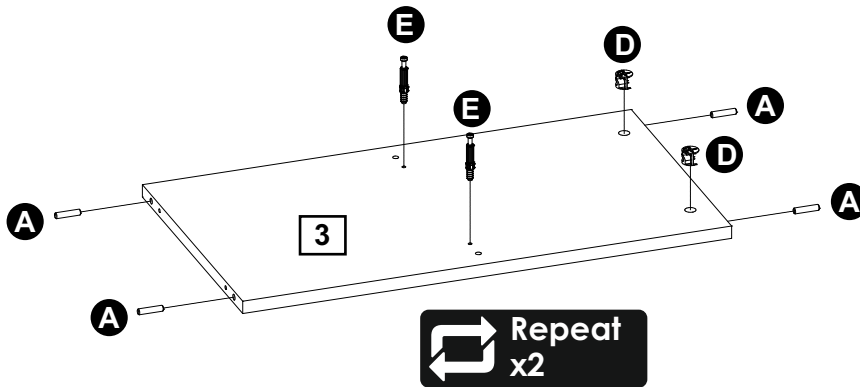
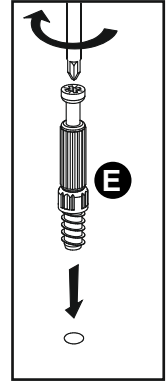
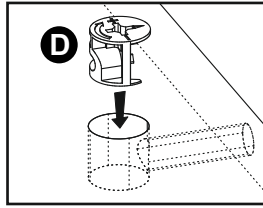
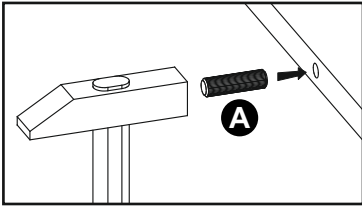
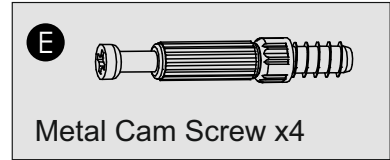
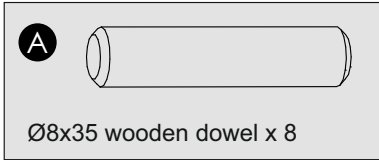

# 6

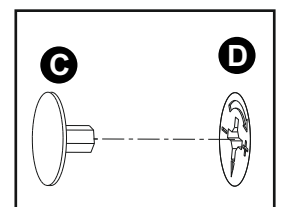
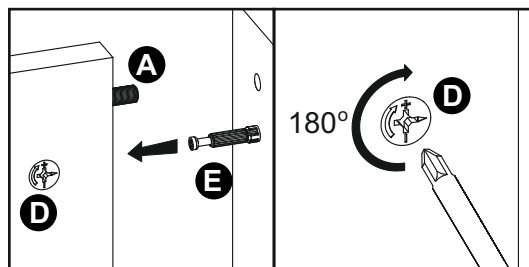
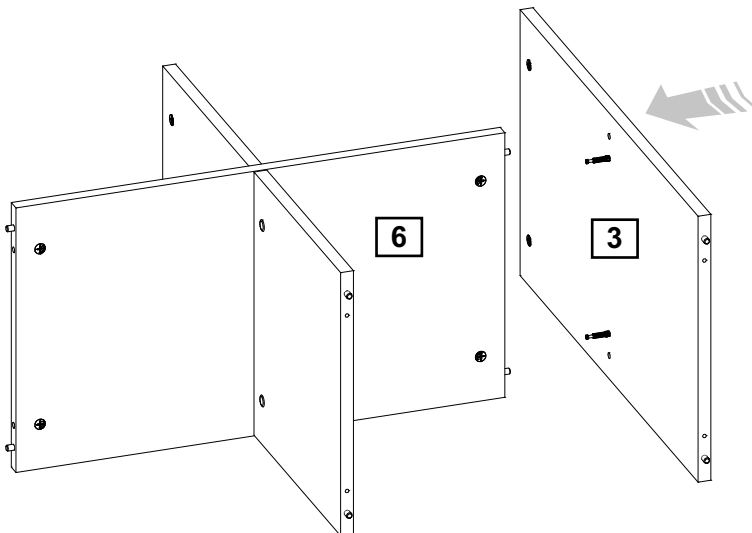
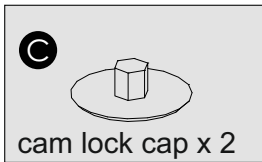

# 7

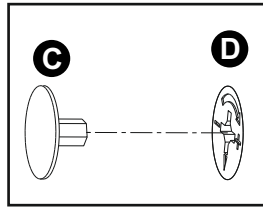
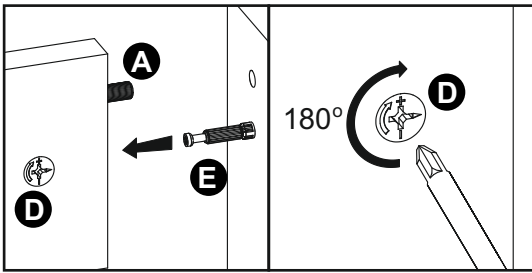
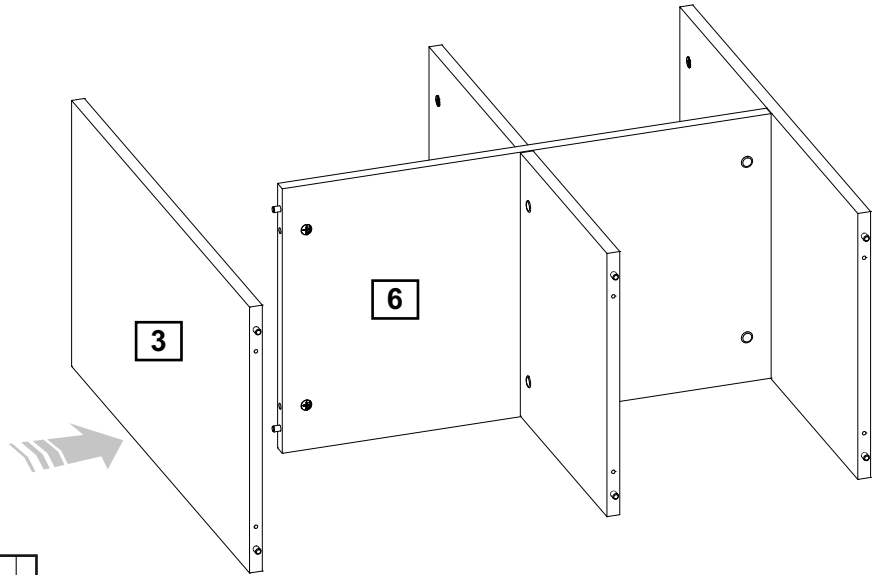
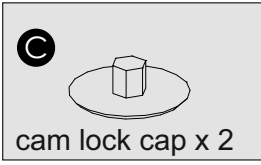

# 8

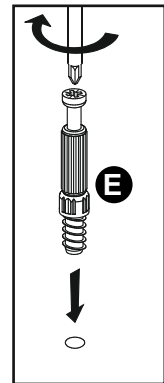
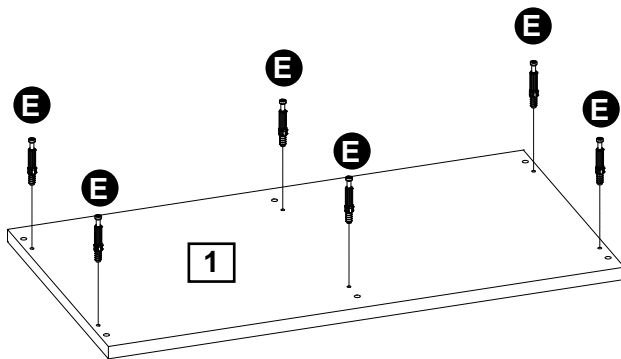
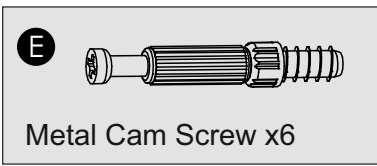

# 9

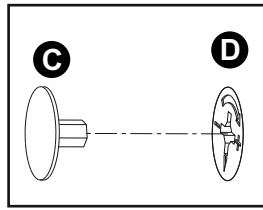
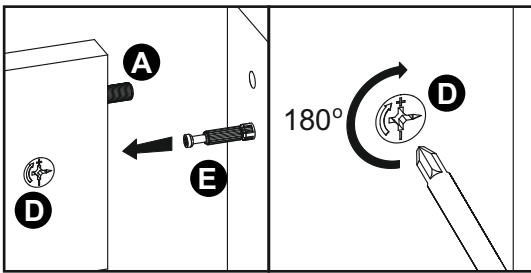
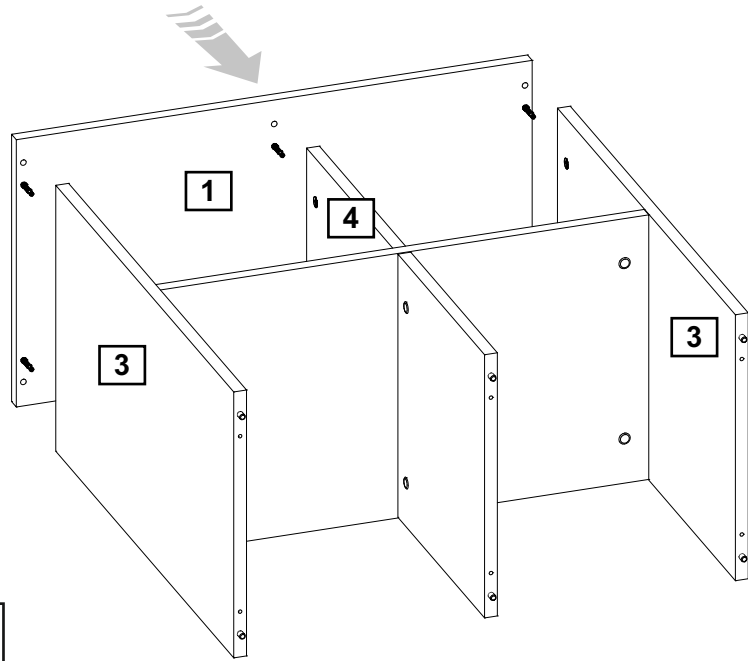
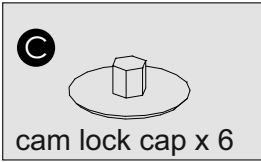

# 10

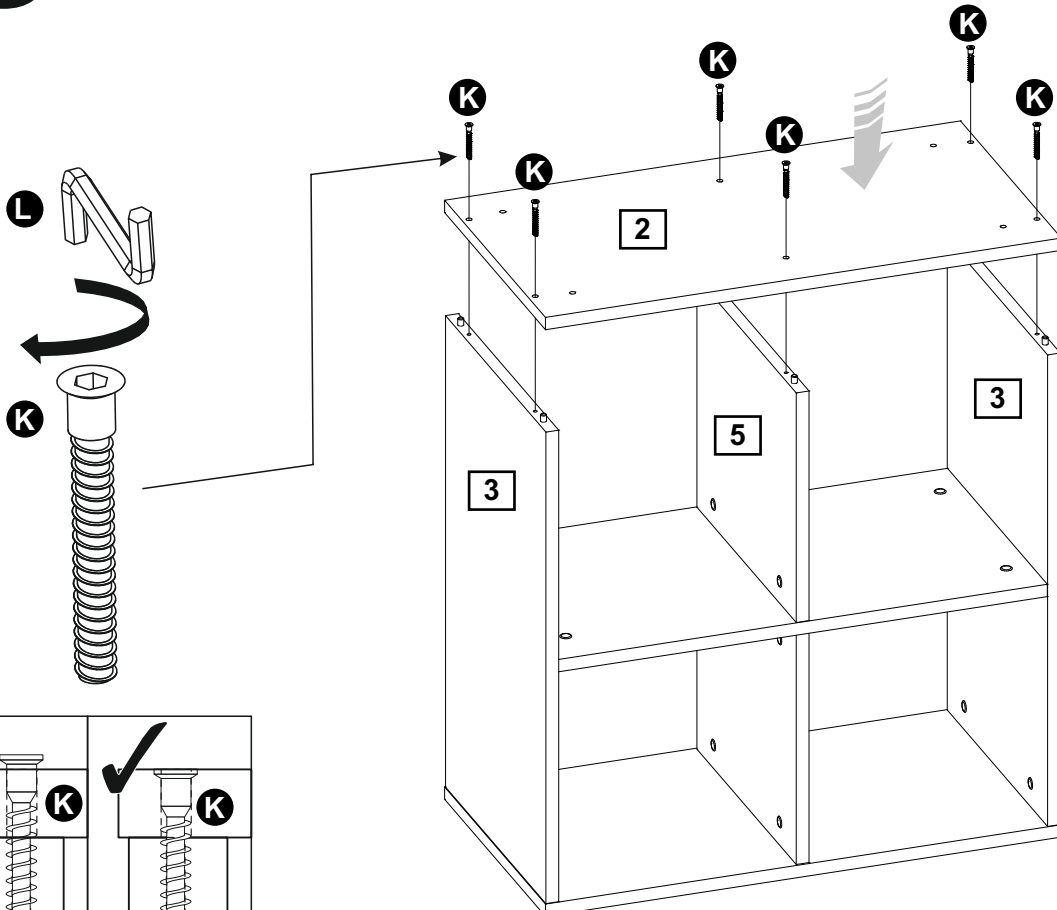
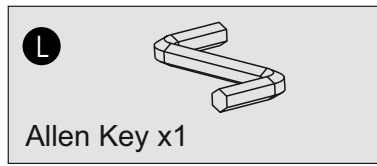
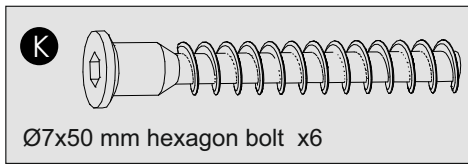

# 11

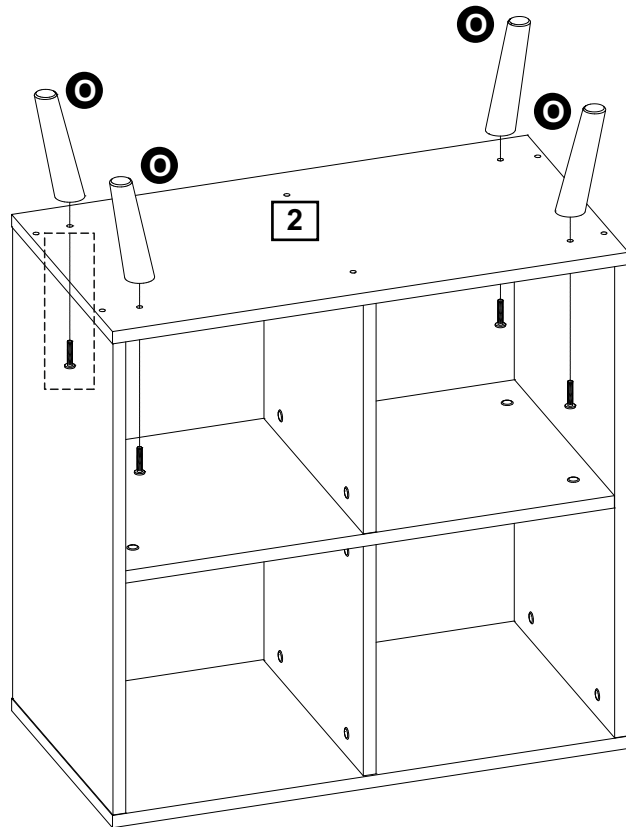
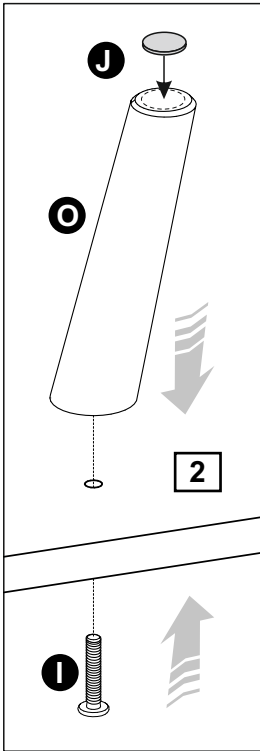
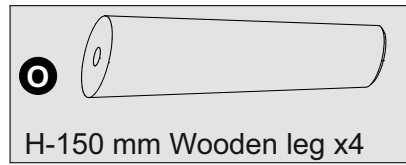
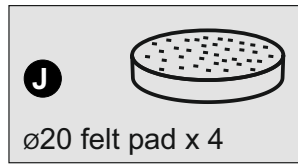
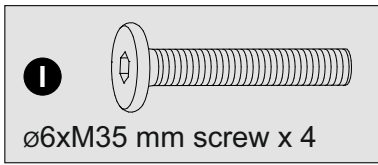

# 12

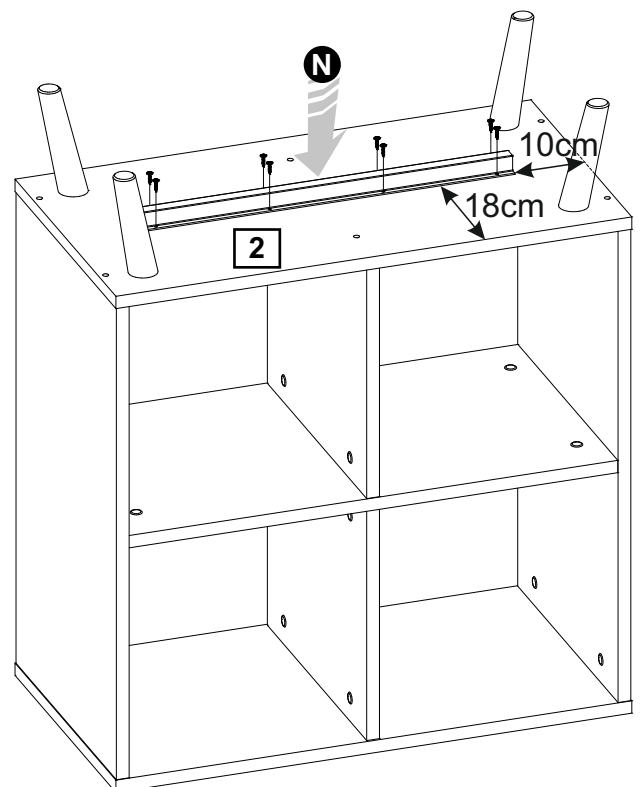
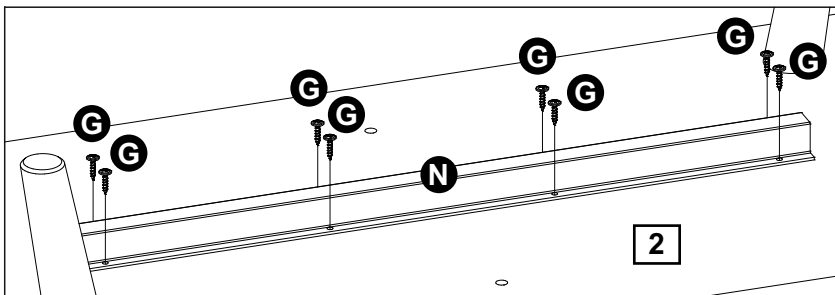
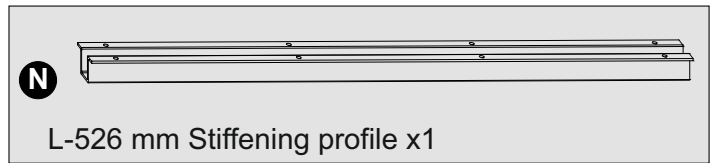
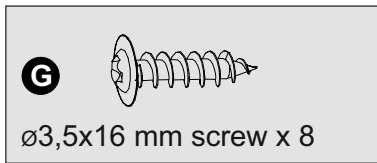

# 13

