

MD 454 IX H

12NC: F096687

GTIN (EAN) code: 5016108966877

Hotpoint

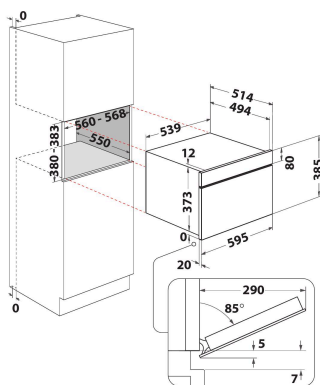

MAIN FEATURES

Product group	Microwave
Commercial code	MD 454 IX H
Main colour of product	Stainless steel
Type of micro-wave oven	MW+Grill function
Construction type	Built-in
Type of control	Electronic
Type of control settings	LED
Additional cooking method Grill	Yes
Crisp	Yes
Steam	No
Additional cooking method Fan cooking	No
Clock	Yes
Automatic programmes	Yes
Height of the product	385
Width of the product	595
Depth of the product	468
Minimum niche height	380
Minimum niche width	556
Niche depth	550
Net weight (kg)	27
Cavity capacity (l)	31
Turntable	Yes
Turntable diameter (mm)	325
Integrated Cleaning system	No

TECHNICAL FEATURES

Current (A)	10
Voltage (V)	230
Frequency (Hz)	50
Length of Electrical Supply Cord (cm)	135
Plug type	UK
Timer	Yes
Grill power (W)	800
Type of grill	Quartz
Cavity material	Stainless steel
Interior light	Yes
Additional cooking method Grill	Yes
Position of interior lights of the cavity	Right side

PERFORMANCES

6th Sense / Dynamic Intelligence	No
Number of power levels	7
Maximum micro-wave power (W)	1000
Bread defrost	No
Jet defrost	Yes
Jet start	Yes