

habitat

Habitat Haxby illuminated bathroom mirror

SKU 3120695

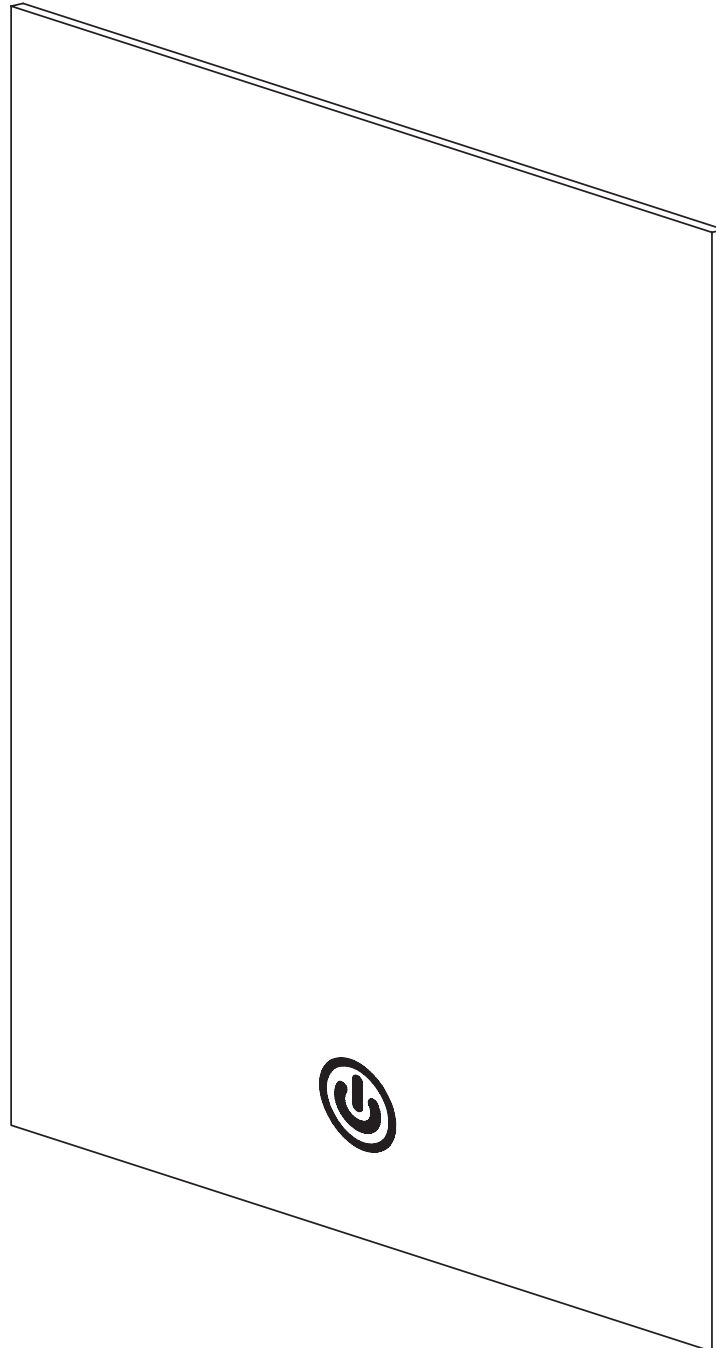

Care & Instruction Manual

For household and indoor use only

Please read and retain these instructions for future reference

Location:

- This fitting is IP44 rated therefore suitable for installation in bathrooms as defined by the I.E.E. Wiring Regulations. IP44 fittings are splashproof, suitable for Zones 1 & 2 except where likely to come in to direct contact with water jets. An example of exceptions would be in a shower cubical or an area where water jets are used for cleaning purposes.
- It is recommended all bathroom appliances be protected by a 30mA RCD Circuit Breaker.
- Please use the Guide below to ensure the correct positioning of your luminaire.

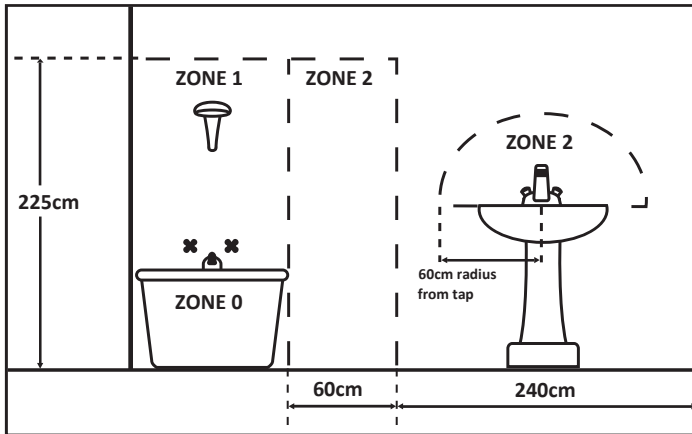

- If in any doubt about the type of wiring you have available or the location of your mirror please consult a qualified electrician.

Instruction to use

Important: Ensure the house electricity supply is off at the fuse board. Ensure other persons cannot restore the electricity supply without your knowledge. Before removing the existing fitting, carefully note the position of each set of cables. If there are loops in cables that are not connected to the light, these must be terminated in a separate terminal block not connected to the fitting.

1. The luminaire should be installed on a smooth surface.
2. Ensure the holes are drilled into a joist or other suitable mounting and not just into plaster.
3. Attach mounting bracket to the wall using suitable fixings.
4. Select the required position for the luminaire; beware of joists, water pipes and electric cables when drilling holes.
5. Connect the supply wires to terminal block, opposite the corresponding wires from the fitting.
 - Black/Blue - Neutral
 - Red/Brown - Live
6. Ensure electrical connections are tight and no loose strands of wire are left out of the terminal block. Switch on the power supply.

Step 1

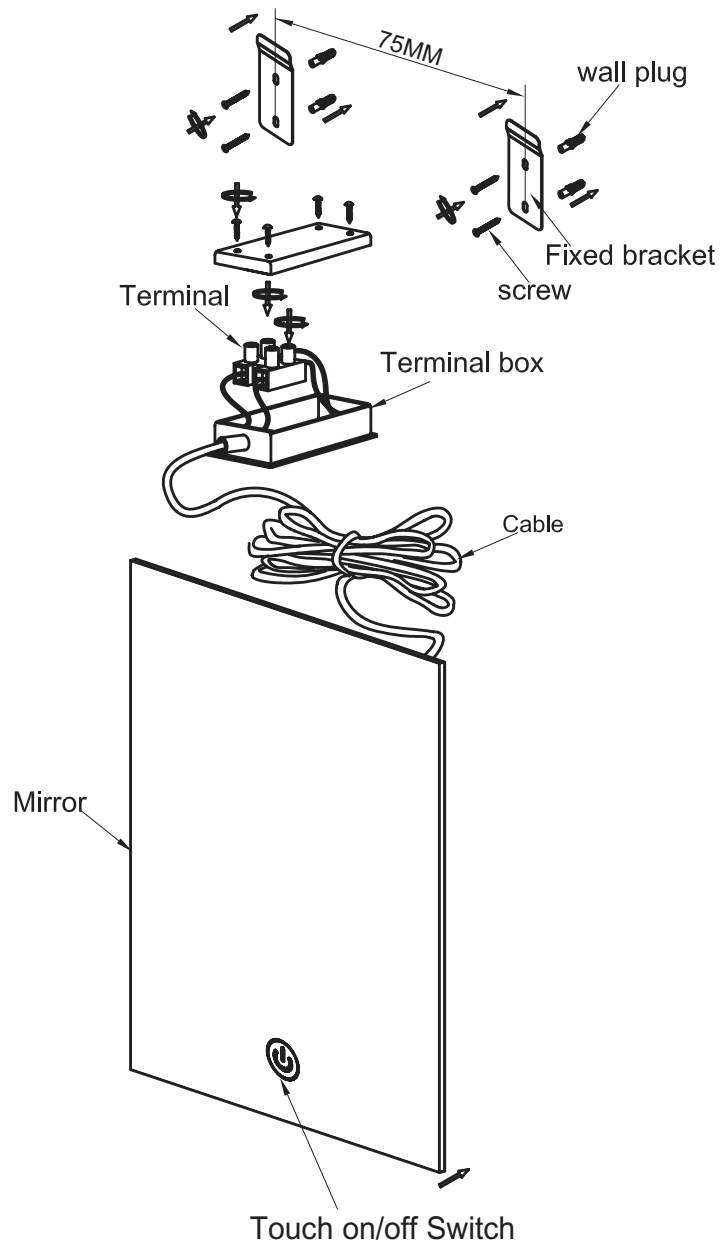

Step 2

Switch Live:
Red/Brown

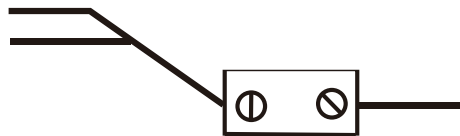

Mains to
luminaire

Neutral:
Black/Blue



(N) Blue

Step 3

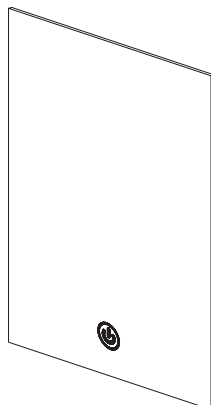

General:

- This luminaire apply touch on/off switch.

Important:

- For your safety, this product must be installed in accordance with local Building Regulations.
- If in any doubt, or when required by the law, consult a competent person who is registered with an electrical self-certification scheme. Further information is available online or from your Local Authority.
- To prevent electrocution, switch off at the mains supply before installing or maintaining this fitting. Ensure other persons cannot restore the electricity supply without your knowledge.
- To avoid damage to concealed wiring during installation, establish the direction of the supply cable before drilling fixing holes.
- This fitting is a Class II appliance.
- Maximum Voltage 220-240V AC 50~60Hz
- Integrated LED-bulbs cannot be replaced.
- Ensure that ALL electrical connections are tight with no loose strands.
- This luminaire is designed for indoor use only.
- Before commencing installation or maintenance, ensure electricity is switched off at the mains.
This luminaire is suitable to be mounted on a Normally Flammable Surface e.g. a material based on wood. This item contains glass - use care when handling to avoid damage or injury.

Maintenance

- Handle with care.
- Do not place very hot or very cold items directly on glass surfaces.
- Do not sit or stand on glass surfaces.
- Do not strike the glass with hard or pointed items, or use the glass as a chopping surface.
- Do not use abrasives cleaning agents, as these may scratch the glass.
- Clean glass with a damp cloth. Use only water / glass-cleaner. Wipe dry with clean a cloth.
- If the glass is chipped or broken, stop using the product.
- Always supervise young children around glass products.

Recycling electrical products

You should now recycle your waste electrical goods and in doing so help the environment. This symbol means an electrical product should not be disposed of with normal household waste. Please ensure it is taken to a suitable facility for disposal.

Visit www.recycle-more.co.uk, click on "bank locator" and enter your postcode to find your nearest recycling site.



We care about quality and what you think,
If you have any comments, good and bad,
please call our Careline:0345 640 2020
or visit www.habitat.co.uk
Your statutory rights are not affected.

Made in China for Habitat. Argos Limited, 489-499 Avebury Boulevard,
Milton Keynes, MK9 2NW. [Argos \(N.I.\) Ltd, Forestside Shopping Centre,
Upper Galwally, Belfast, United Kingdom, BT8 6FX.](http://www.argos.co.uk)
Argos Distributors (Ireland) Limited, Unit 7, Ashbourne Retail Park,
Ballybin Road, Ashbourne, County Meath, Ireland.

Wall Mounting & Fixings

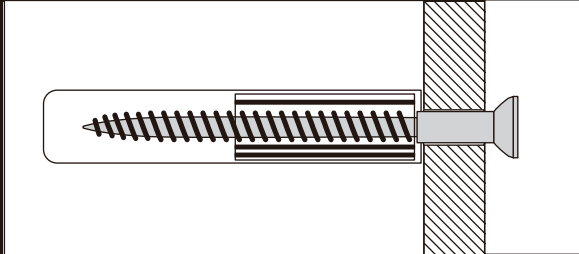

IMPORTANT:

When drilling into walls always check that there are no hidden wires or pipes etc. Make sure that the screws and wall plugs being used are suitable for supporting your unit. Consult a qualified tradesperson if you are unsure.

HINTS:

- 1) General Rule  Always use a larger screw and wall plug if you are not sure.
- 2) Ensure you use the recommended drill bit to match the wall plug and hole size.
- 3) Ensure you drill the hole horizontally, do not force the drill or enlarge the hole.
- 4) Take extra care when drilling high walls, ceilings and ceramic tiles. Ensure the plug is fitting below the ceramic tile to avoid splitting or cracking.
- 5) Ensure wall plugs are well fitted and are a tight fit in the drilled hole.

Types Of Walls

You can use one of the following types of wall plug if your walls are made of brick, breeze block, concrete, stone, wood or plaster board.

No.1 "Standard" Wall Plug General Wall Materials

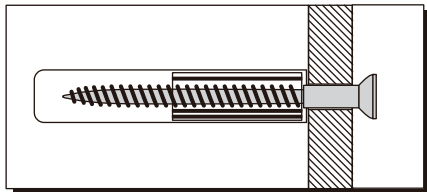

These come in various sizes and are made from plastic or sometimes wood fiber.

No.2 "General Purpose" Wall Plug Aerated / Breeze Block

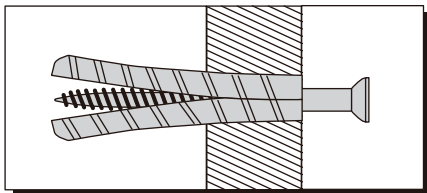

Generally aerated blocks should not be used to support heavy loads, use a specialist fitting in this case. For light loads, a General Purpose Plug can be used.

No.3 "Shield Anchor" Wall Plug Heavy Loads

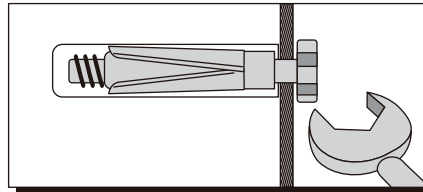

For use with heavier loads such as TV & HiFi Speakers and Satellite Dishes etc.

No.4 "Cavity Fixing" Wall Plug

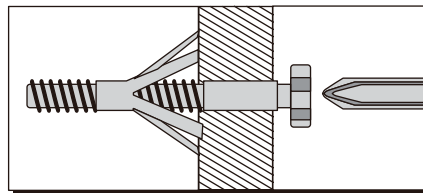

For use with plaster board partitions or hollow wooden doors.

No.5 "Cavity Fixing - Heavy Duty" Wall Plug

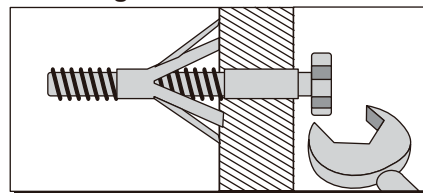

For use when fitting or supporting heavy loads such as shelving, wall cabinets, coat racks.

No.6 "Hammer Fixing" Wall Plug

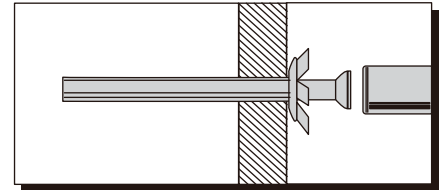

For use with walls stuck with plaster board. The hammer fixing allows it to be fixed to the wall rather than the plaster board. Always check the fixing is secure to the retaining wall.

CARE & MAINTENANCE

SAFETY

Always check the fitting and location to ensure your safety in and around the home.

FITTING

From time to time check the fitting to ensure the wall plugs or screws do not become loose.