

Cream Decorative Gazebo

Assembly Instructions - Please keep for future reference

309/1449

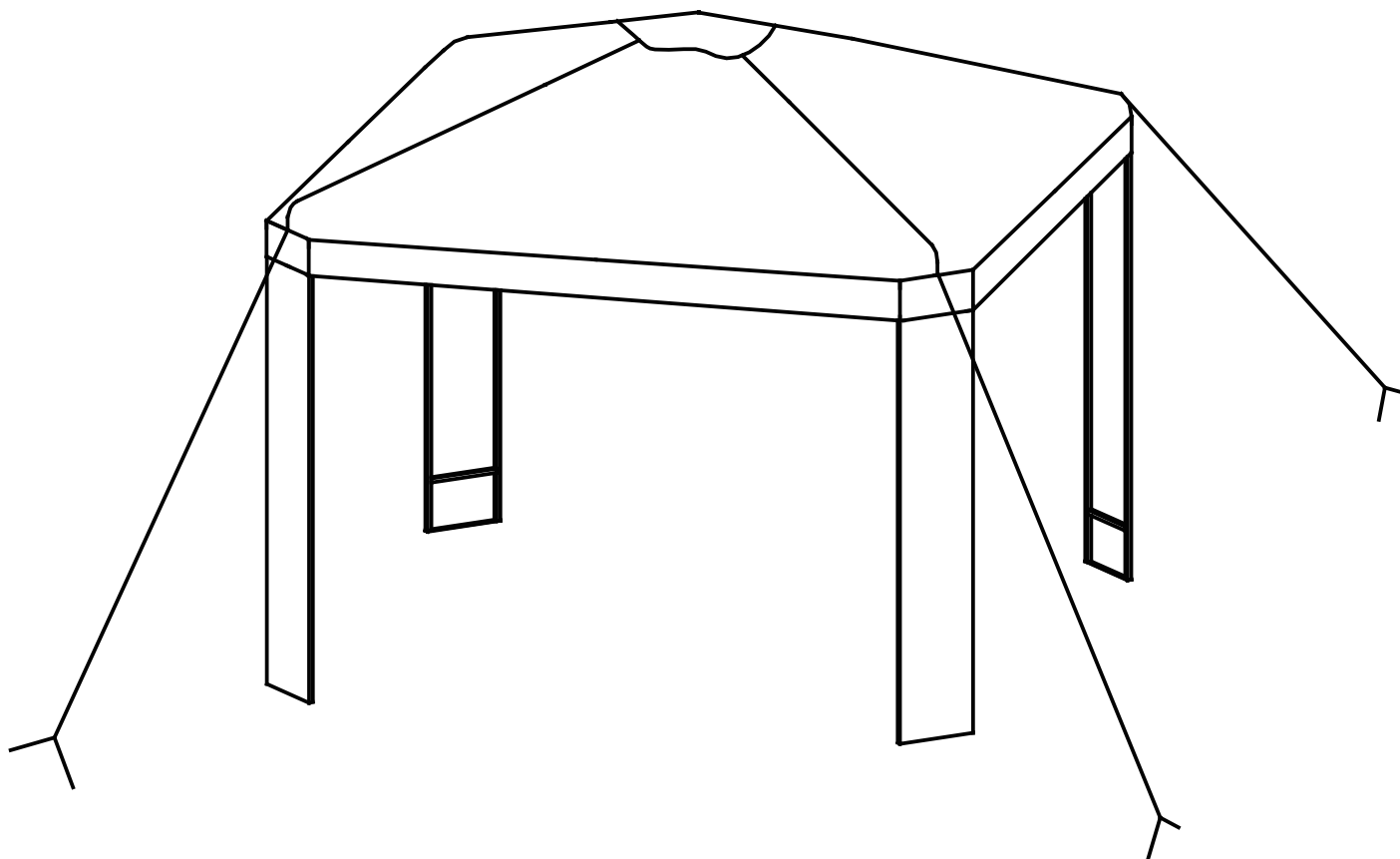

Dimensions

Width - 300cm

Depth - 300cm

Height - 260cm

Important - Please read these instructions fully before starting assembly

If you need help or have damaged or missing parts, call the **Customer Helpline:**

Argos = 0345 640 0800

Address: 489-499 Avebury Boulevard Saxon Gate West, Central Milton Keynes Bucks, MK9, 2NW



IMPORTANT SAFETY INSTRUCTIONS

Read all instruction before using and keep for future reference

- Read these instructions carefully and familiarise yourself with the procedure before assembling the unit.
- Check that you have all the component parts following the list on the page 3 and familiarise yourself with each part before proceeding.
- Take all the fittings out of the plastic bag and separate them into their groups.
- Ensure you have enough space to lay out all the parts before assembly.
- To avoid scratching it is recommended that you assemble the unit on a soft level surface.
- Please keep children away when assembly. Please keep children under direct supervision of adult when using.
- **Please do not use the gazebo under windy condition.**
- Always use guy rope and pegs to secure the gazebo when using.
- This Gazebo is not a permanent structure and should be disassembled and stored away after using.
- Do not repack your Gazebo until completely dry.
- We recommend assembly by four persons under light or no wind conditions.
- This Gazebo must not be left erect in windy conditions.
- Keep the Gazebo Fabric away from screws, nails, staples, hooks, etc to avoid damage to the fabric and frame.
- **Warning:** The unit weight approximately 16.2 kgs.
- **Please lift with care.**

CAUTION

Fire precautions

- Do not place the Gazebo near lights, fireplaces, gas or electric heaters, candles, radiators, or any other sources of heat, fire or flammable liquids.
- This Gazebo features a Fabric cover that is not retardant.
- We recommend caution and common sense when in use.
- This Gazebo can burning.
- Do not use naked flames in or around the Gazebo. We recommend you advise no smoking while inside.
- This Gazebo has no flame retardant cooking area and should not be use to house BBQs or other cooking methods.

Safety

- To avoid any risks of suffocation to animals or children dispose of the plastic bags immediately.



Cleaning

- As with all surfaces clean with a damp cloth and mild detergent, do not use bleach or abrasive products.

Components - Parts

If you have damaged or missing components, call the Customer Helpline: Argos = 0345 640 0800

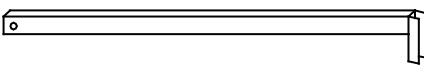
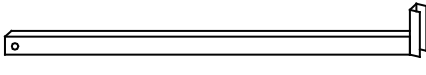
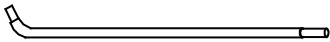
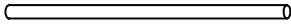
Please check you have all the parts listed below

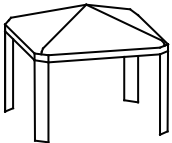
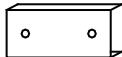
<p>1</p>  <p>4xLeg Pole (1930 x 340mm)</p>	<p>2</p>  <p>4xSupport Pole(15 x 25mm)</p>	<p>3</p>  <p>4xSupport Pole(15 x 25mm)</p>
<p>4</p>  <p>4xTop Pole (φ 18)</p>	<p>5</p>  <p>4xTop Pole (φ 18)</p>	<p>6</p>  <p>1xCenter Connector</p>
<p>7</p>  <p>1xGazebo Cover</p>	<p>8</p>  <p>8x Metal Connector</p>	

Components - Fittings

Please check you have all the fittings listed below

Note: The quantities below are the correct amount to complete the assembly. In some cases more fittings may be supplied than are required.

- A**



4x Guy Rope
- B**



M6x25

8x
- C**



M6x30

16x
- D**

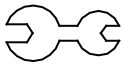

1x
- E**



M6

24x
- F**

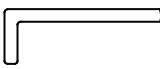

12x Peg
- G**



16x

Assembly Instructions

Step 1

Assembling support poles

Connect support pole **2** and **3** with screws.



Important note:

Because of the size of this unit we recommend that it is built in the place intended for using.

Ensure to locate the unite on the flat ground free from obstruction, in a sheltered area away from wind and heavy rain as this will damage the unit.

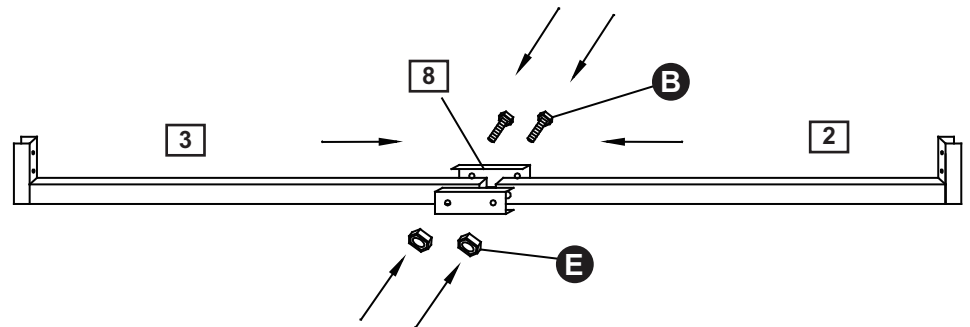

Step 2

Assembling top poles

a: insert top poles **4** into the top poles **5**

Ensure all the poles are fully inserted and secure.

b: insert top poles **5** into the center connector **6**

Note: It would be useful to ask someone to help you at this step.

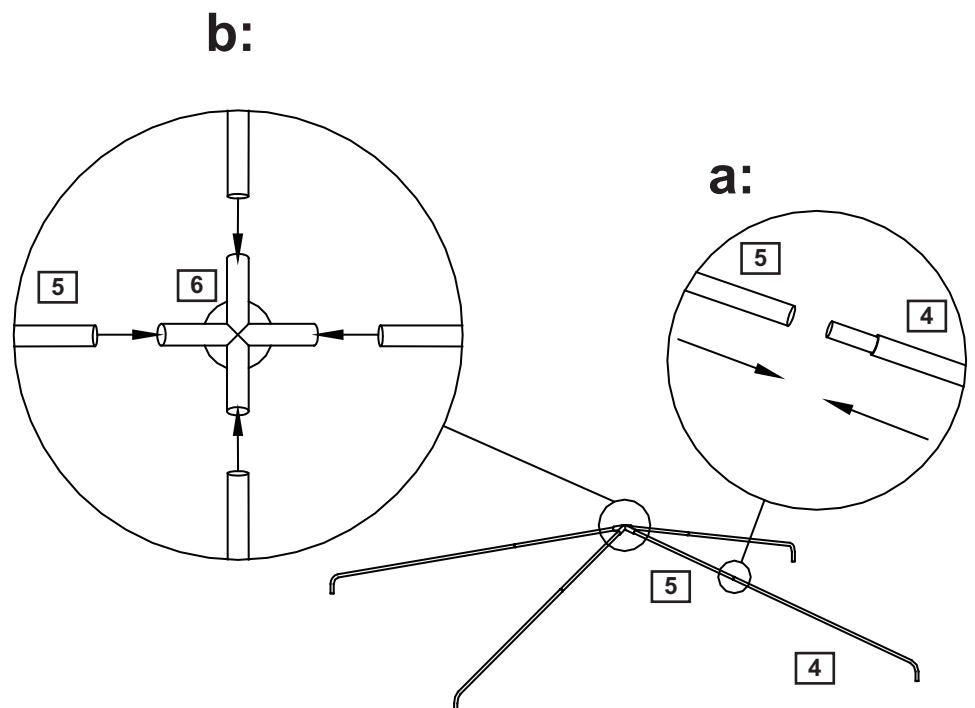

Assembly Instructions

Step 3

Assembling Leg poles

This step needs at least two persons for assembling. One person need hold middle of the connected support pole when the other one is connecting the leg poles **1** with screws



Important note:

This product must be assembled by at least 2 persons

One person must hold the middle of connected support poles.

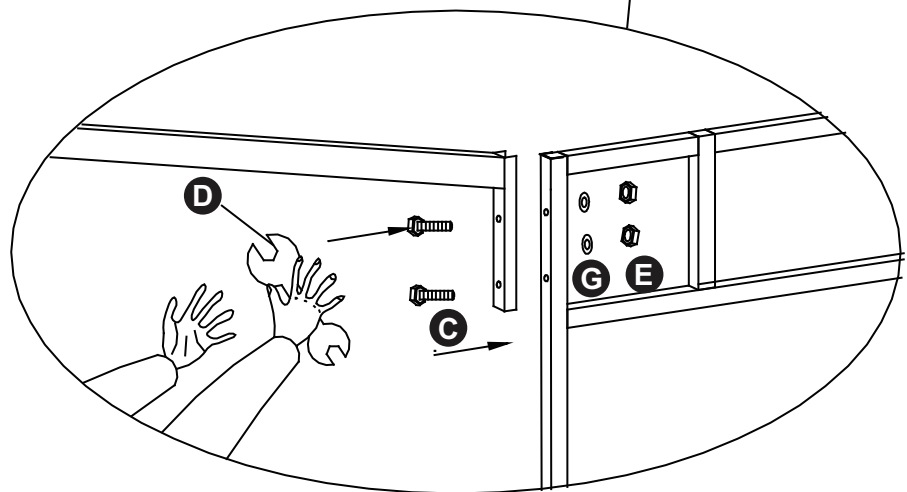
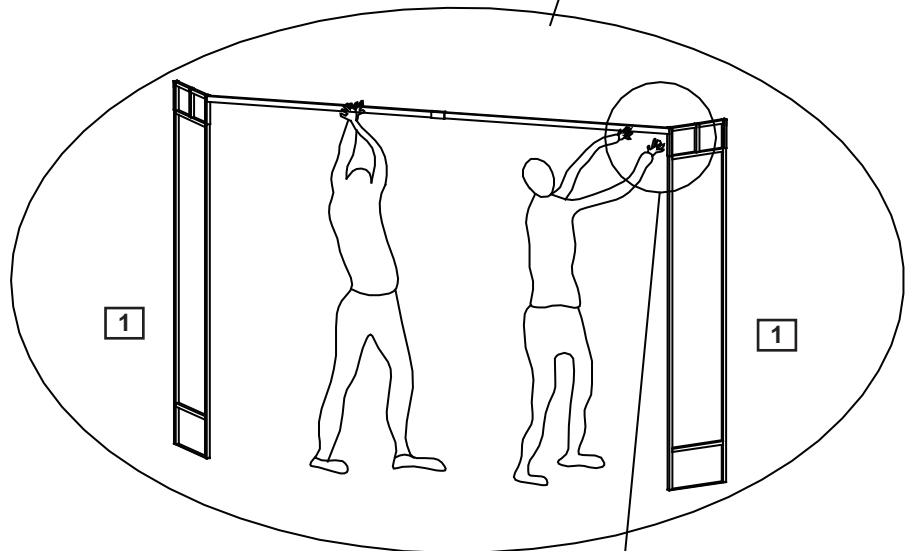
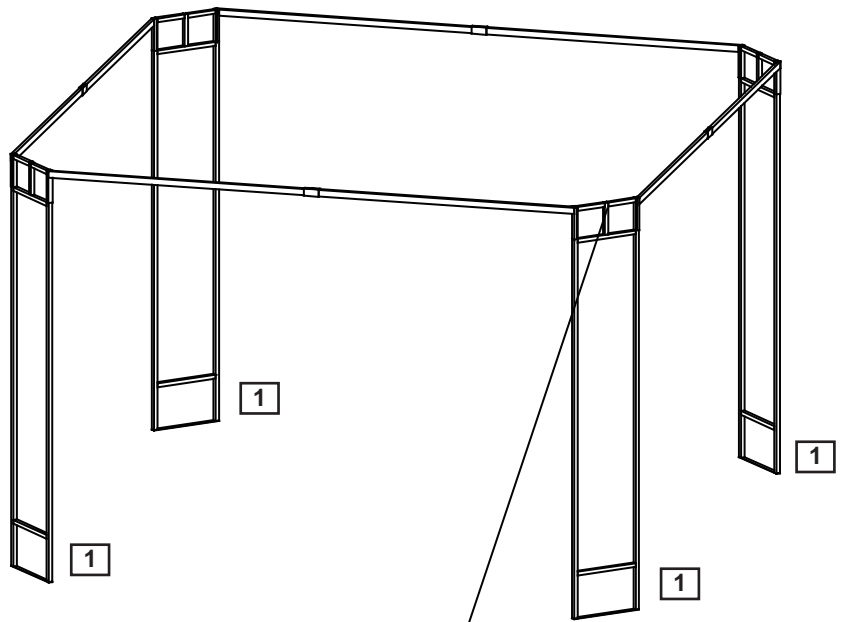

Assembly Instructions

Step 4

Assembling top poles

The connected top poles **4** insert into the hole of leg poles **1**. This step need one person hold the frame when the other one is assembling.

Note: It would be useful to ask someone to help you at this step.

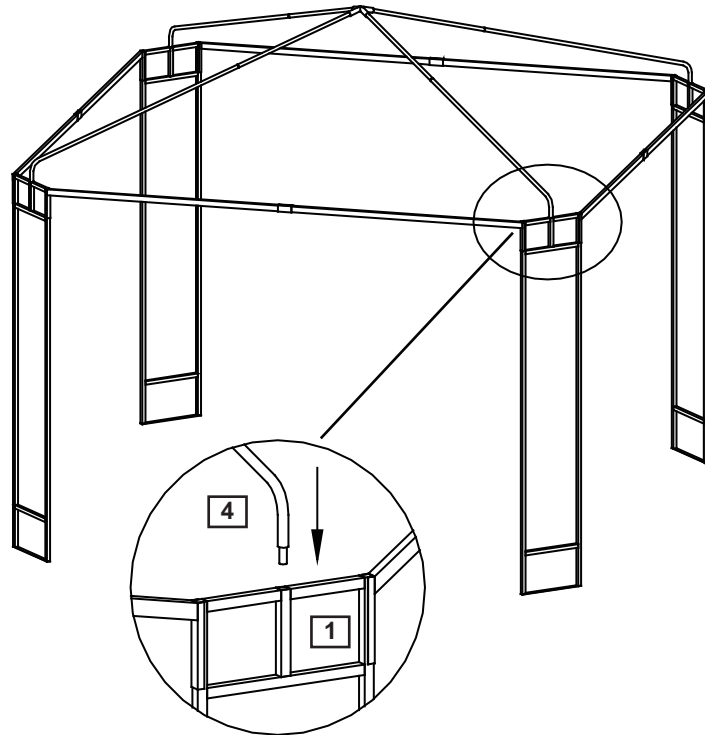

Step 5

Assembling gazebo covers

Carefully place the gazebo cover **7** over the assembled roof. Then pull the gazebo tightly over the assembled roof frame.

Note: It would be useful to ask someone to help you at this step.

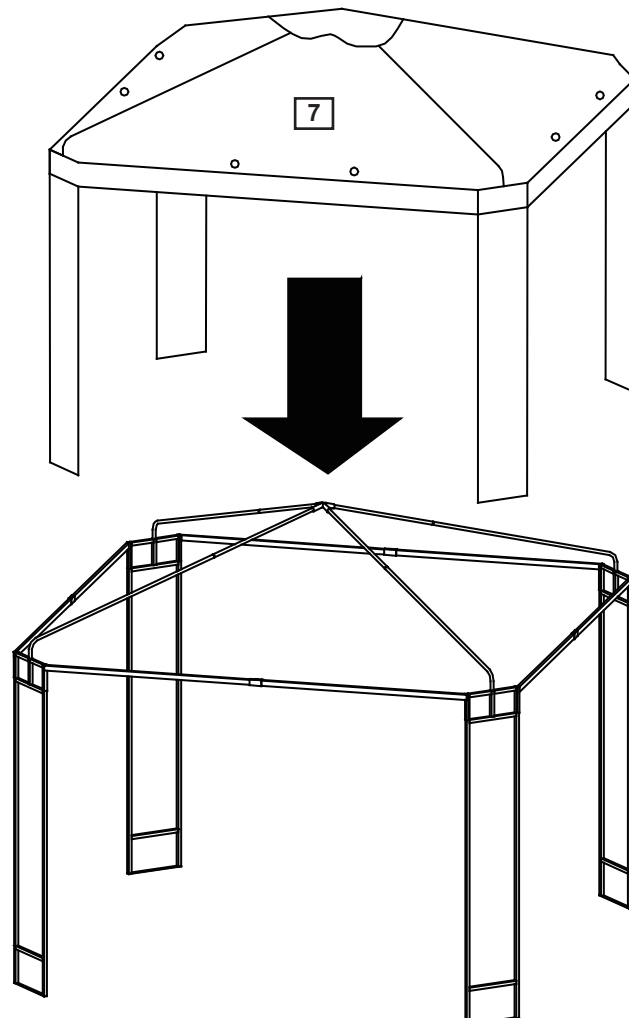

Assembly Instructions

Step 6

Fixing gazebo cover

a: use the velcro tapes inside the gazebo cover to fix it onto the assembled frame

b: attach the gazebo cover's hooks into holes on the leg poles **1**
Tighten by moving the hook to a lower hole.

Note: It would be useful to ask someone to help you at this step.

Step 7

Fixing the guy ropes

c: attach the end of guy ropes **A** to the corner of the top cover on the gazebo. Then attach the other end to the peg **F** and drive the peg into the ground.

Repeat above steps to assemble the other guy ropes.

d: use the peg **F** to fix the leg poles **1**

Note: the pegs are for location purposes only, they will not support the unit in high winds, see above instructions.

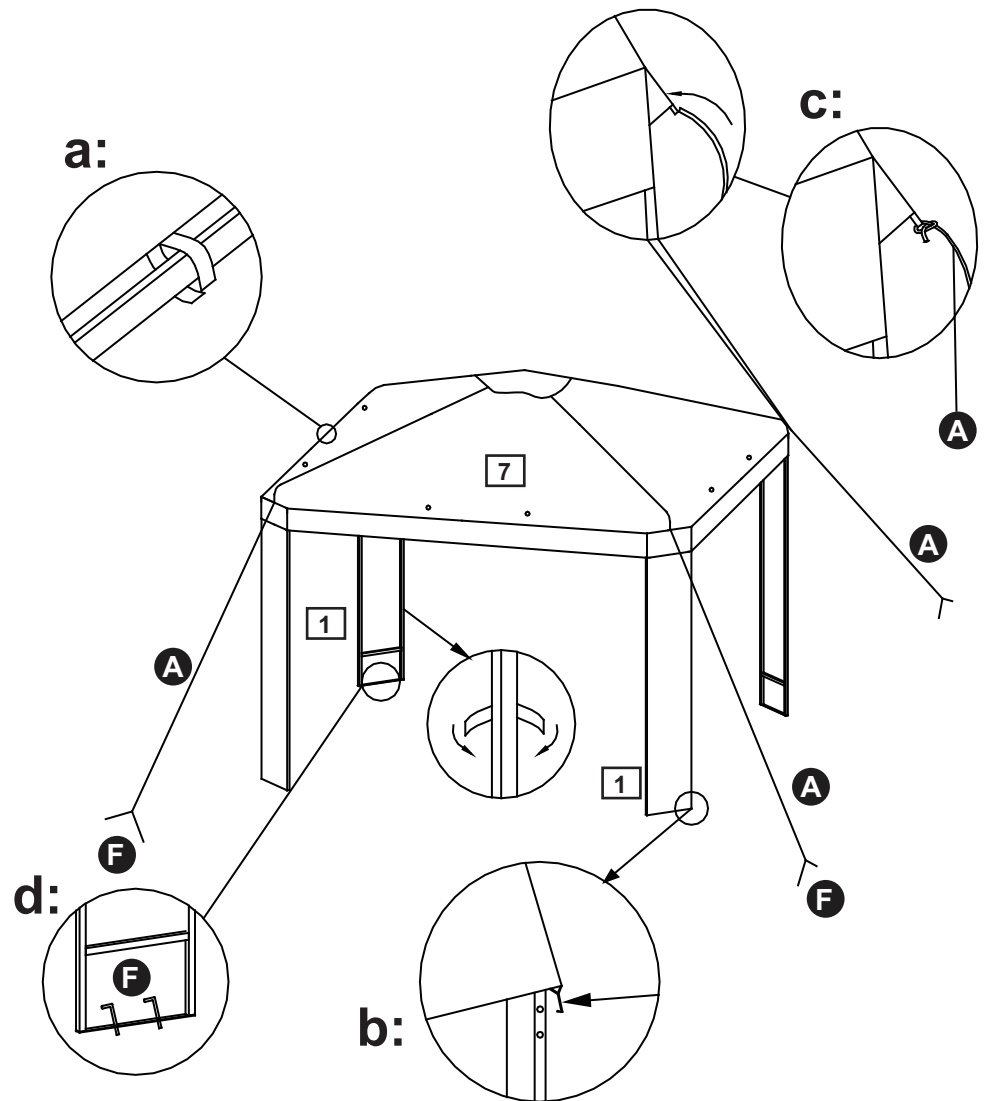

Assembly Instructions

Step 8

Warning:

Do not assemble or disassemble during strong winds.

a: Drainage holes prevent rain water collecting.

Assembly is complete.

Note: It would be useful to ask someone to help you.

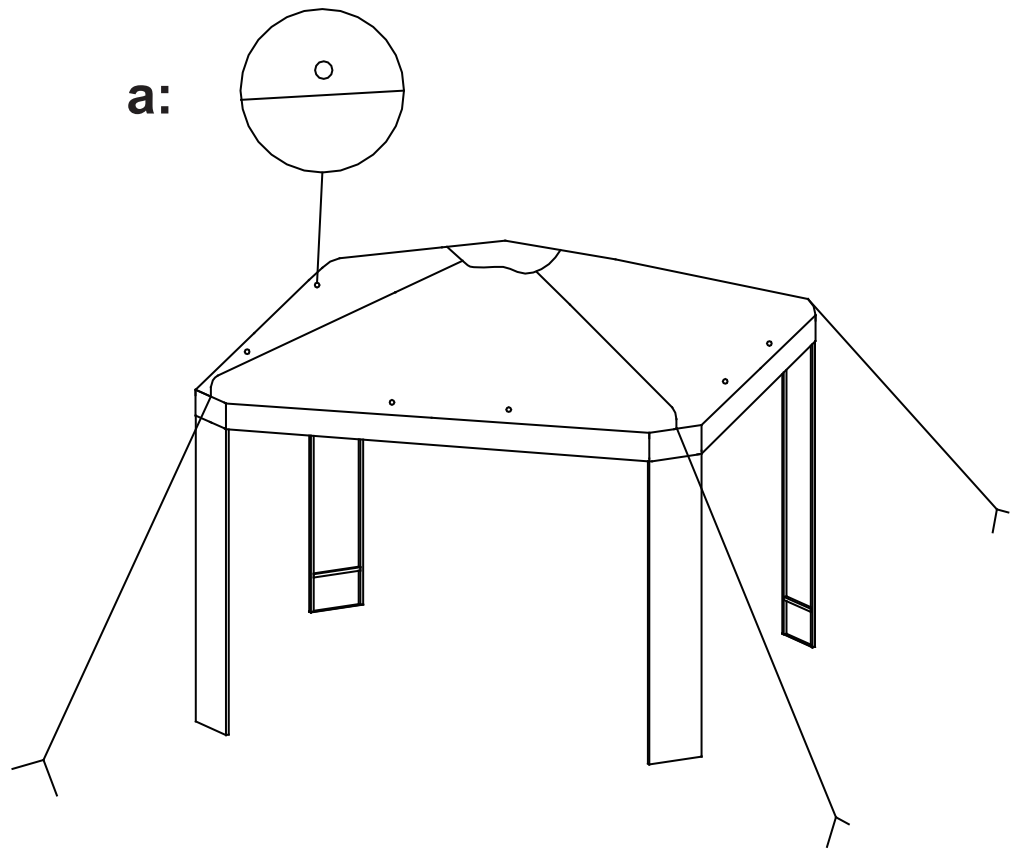

Important note: always use this product with caution and read the important safety instructions.

If you need help or have damaged or missing parts, call the **Customer Helpline:**

Argos = 0345 640 0800

Address: 489-499 Avebury Boulevard Saxon Gate West, Central Milton Keynes Bucks, MK9, 2NW