



76259





LEGO.com/sustainable-packaging

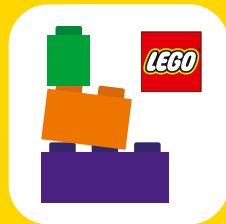

BUILDER



Apple and the Apple logo are trademarks of Apple Inc., registered in the U.S. and other countries and regions. App Store is a service mark of Apple Inc. Google Play and the Google Play logo are trademarks of Google LLC. Tencent and the Tencent logo are trademarks of Tencent Inc.

Q [LEGO.com/devicecheck](https://www.lego.com/devicecheck)

EN Ask parents' permission before going online | **DE** Eltern um Erlaubnis bitten, bevor du online gehst | **FR** Demande l'autorisation d'un parent avant d'aller en ligne | **IT** Chiedi il permesso ai tuoi genitori prima di andare online | **ES** Pídeles permiso a tus papás antes de conectarte a Internet | **PT** Peça autorização aos pais antes de acederes online | **ZH** 上网前应先征得父母的同意 | **PL** Poproś rodziców o zgodę, zanim wejdziesz do Internetu | **CS** Než půjdeš na internet, požádej rodiče o svolení | **SK** Skôr než pôjdeš na internet, vypýtaj si povolenie od rodičov | **HU** Kérj szülői engedélyt, mielőtt online csatlakoznál! | **RO** Cere permisiunea părinților înainte de a te conecta online | **BG** Поискайте разрешение от родител, преди да влезете онлайн | **LV** Pirms došanās tiešsaistē palūdz atļauju vecākiem | **ET** Enne Interneti kasutamist küsi vanematelt luba | **LT** Prieš prisijungdami prie interneto, atsi klauskite tėvų

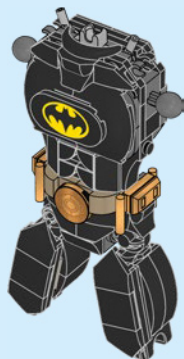

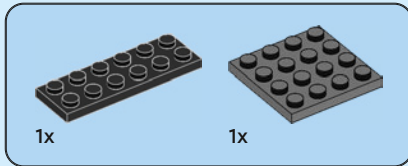

1

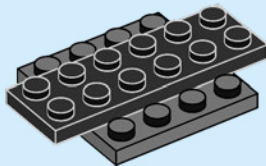



2x



2x

2

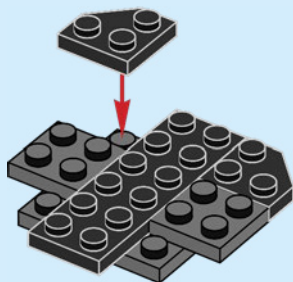

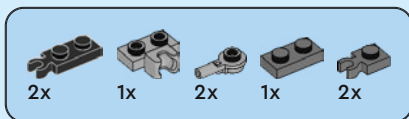

3

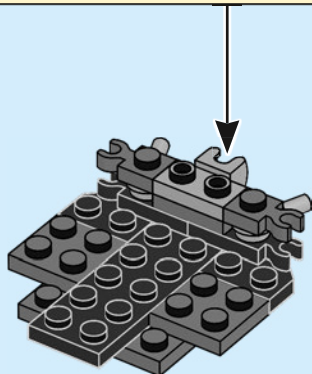
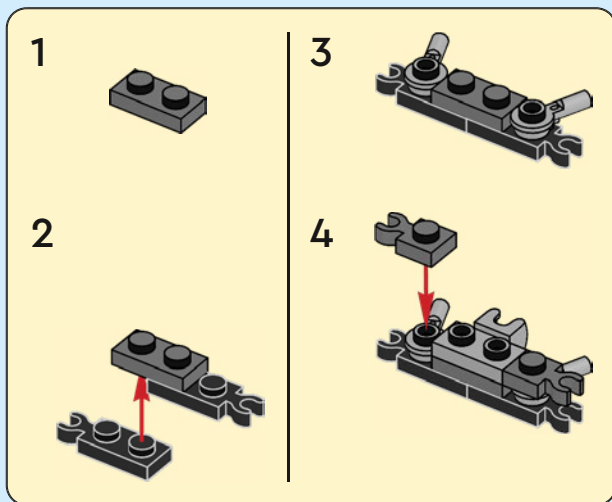

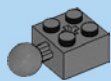

2x



1x

4

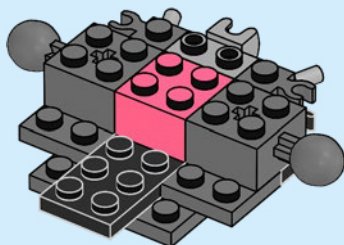

2x

5

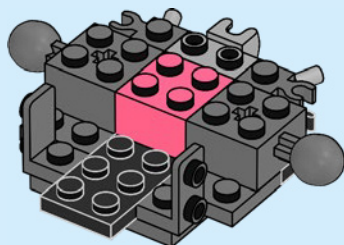



2x



1x

6

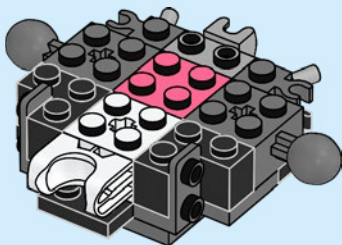

1x



2x

7

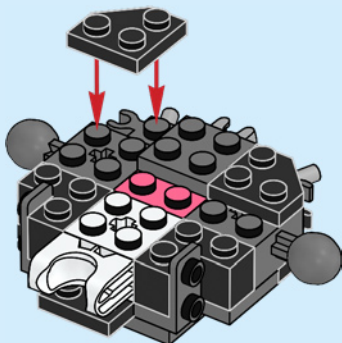

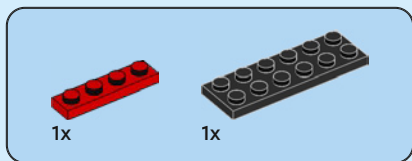

8

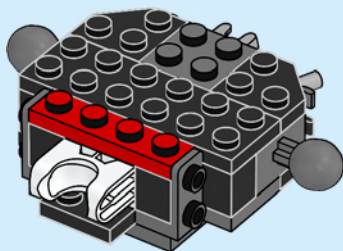

9

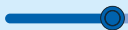
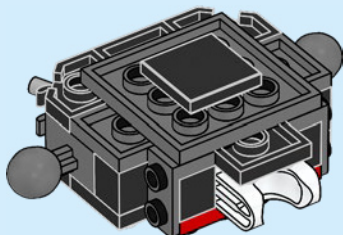

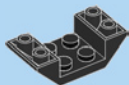

1x

10

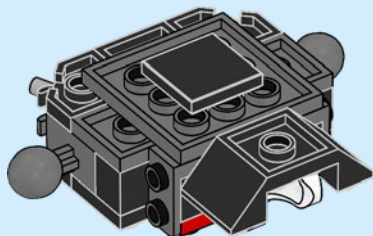

4x

11

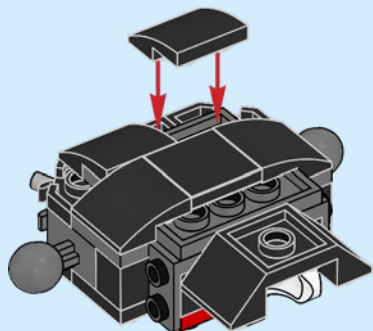

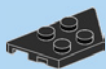

1x

12

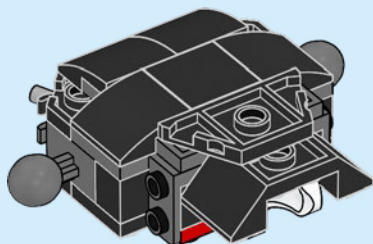

2x

13

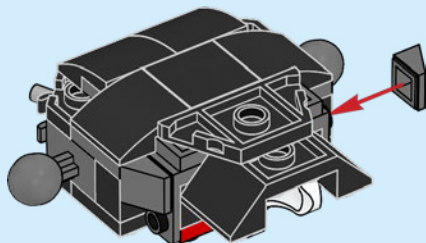



4x

14



4x

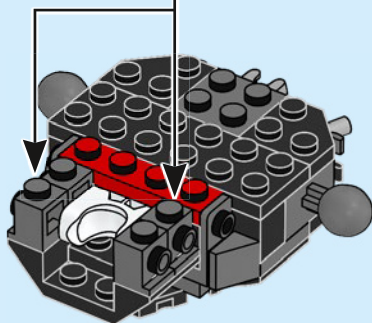



2x

15



2x

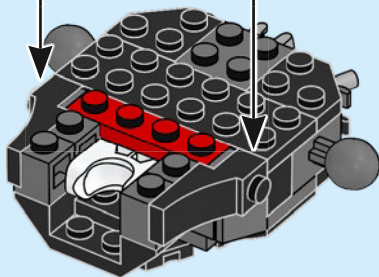

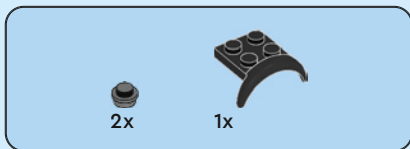

16

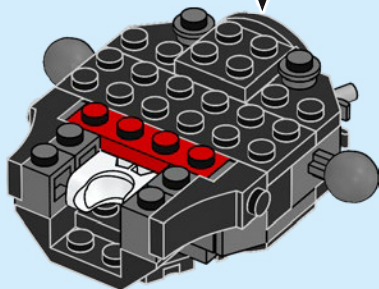



2x

17

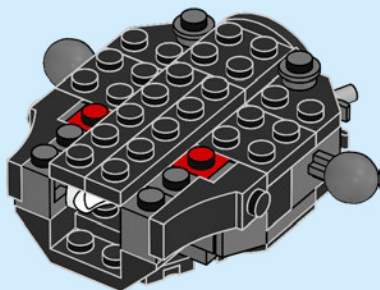

2x



2x

18

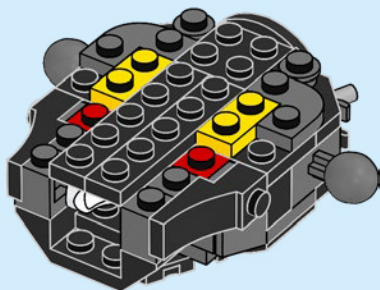



2x

19

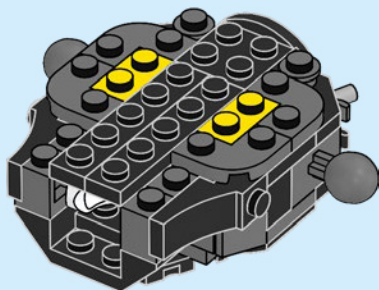

1x



1x

20

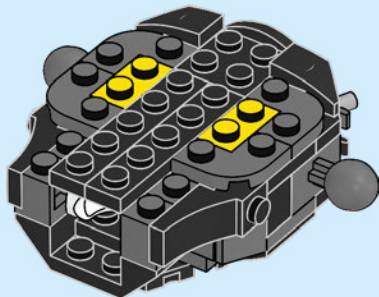

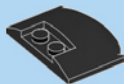

2x

21

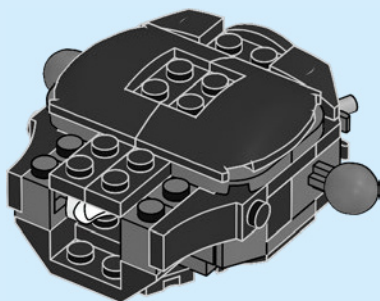

1x

22

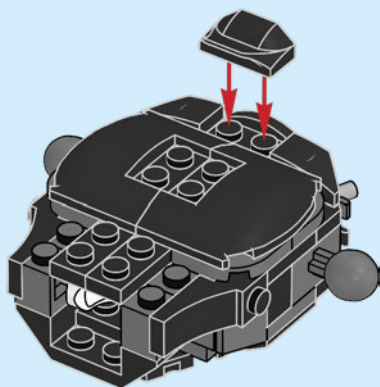



1x

23

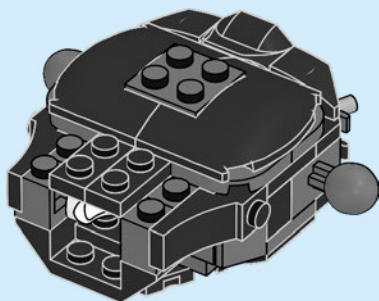

2x

24

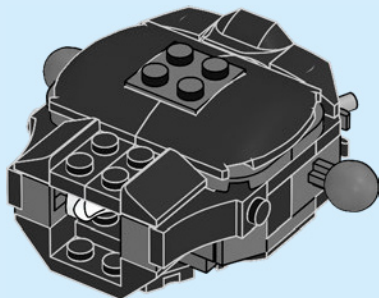



4x

25

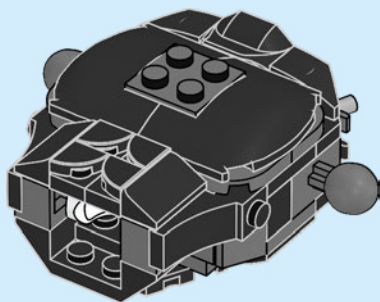

1x

26

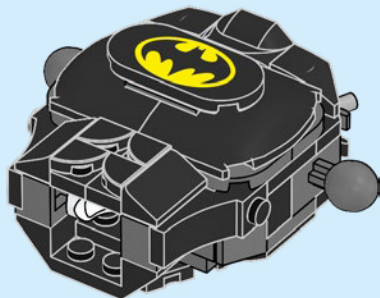

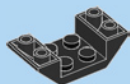
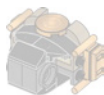

1x

27

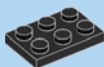
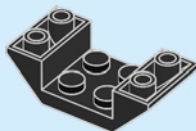

1x

28

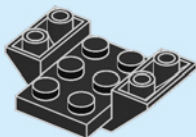



1x

29

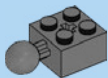
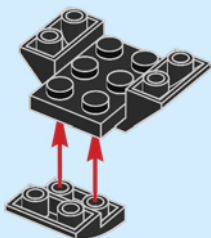

1x

30

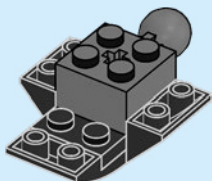



2x

31

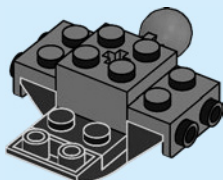

2x

32

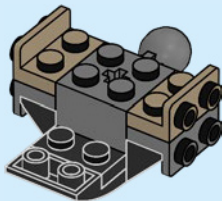



2x

33

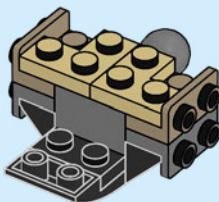

2x

34

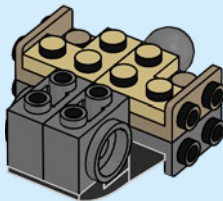



1x

35

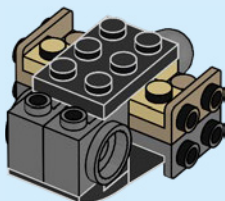

2x

36

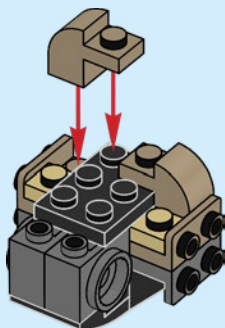

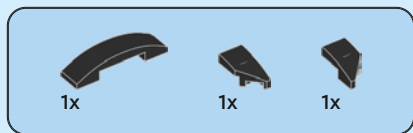

37

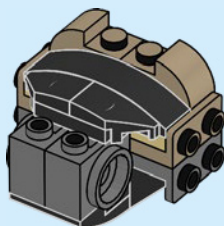

38

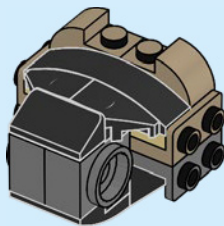

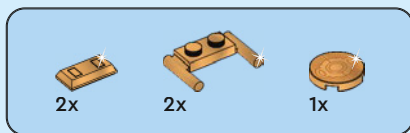

39

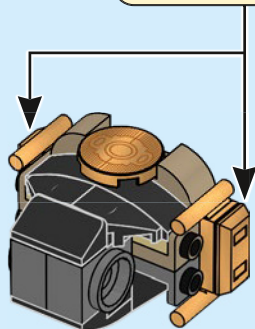
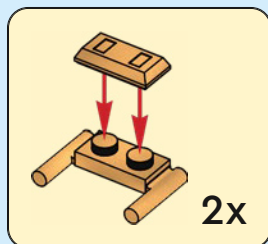

40

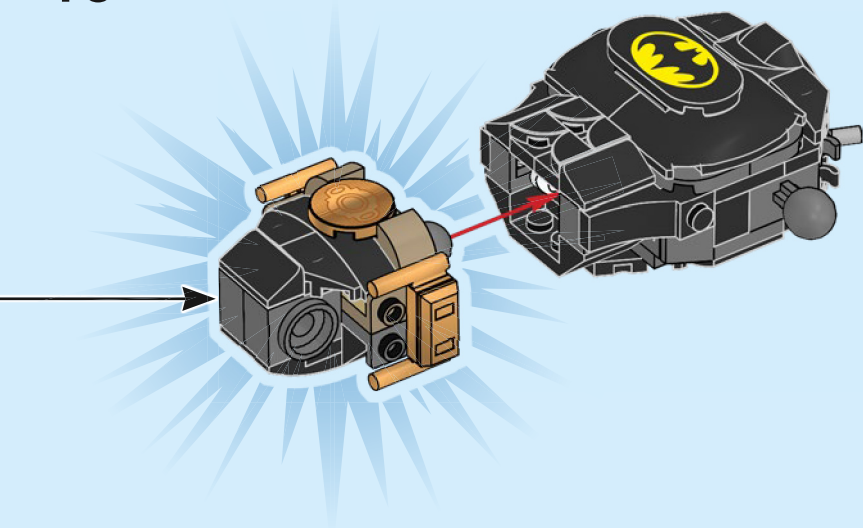

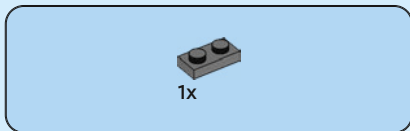
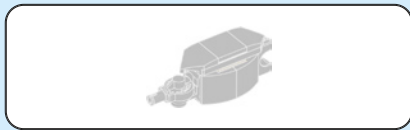

41

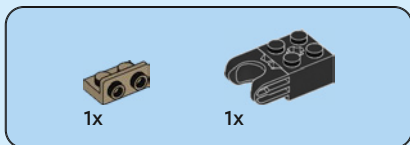
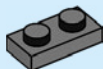

42

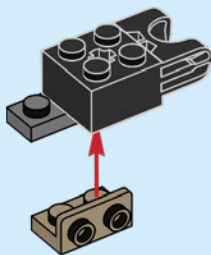



1x



1x

43

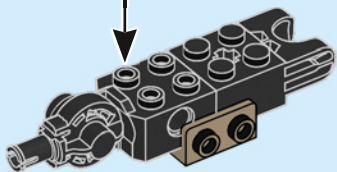
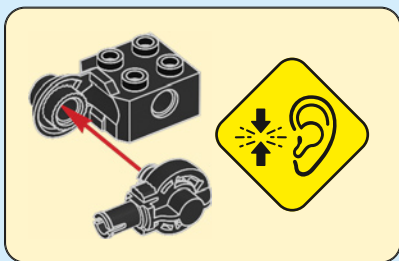

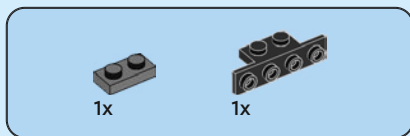

44

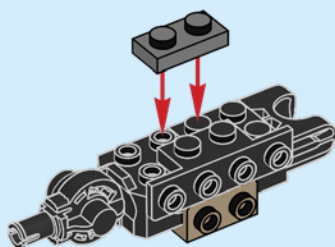

45

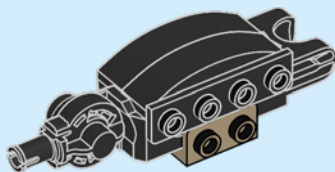

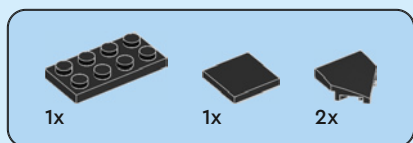

46

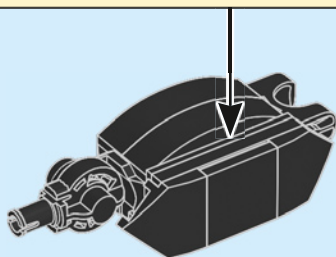
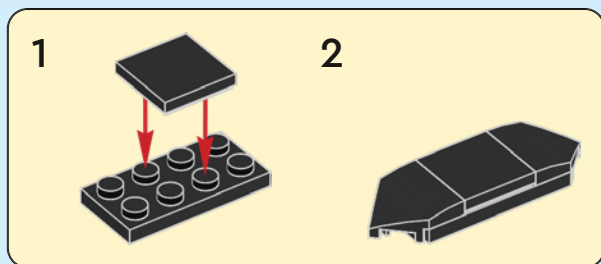



2x

47

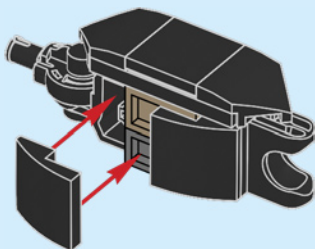

48

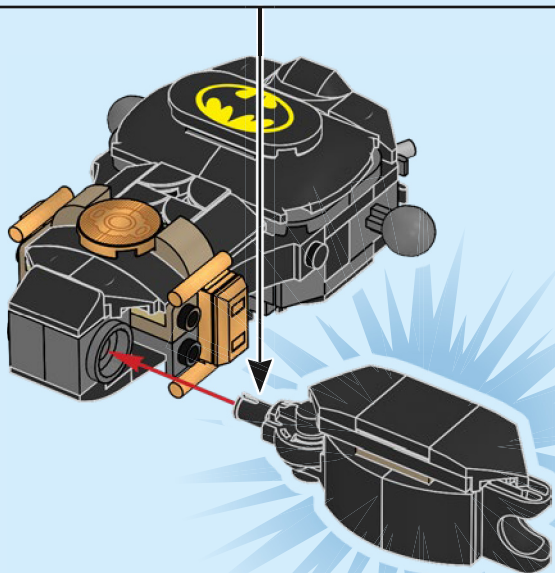

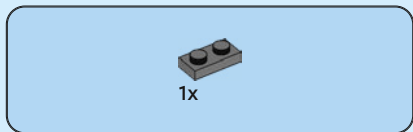
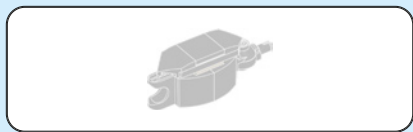

1x

49

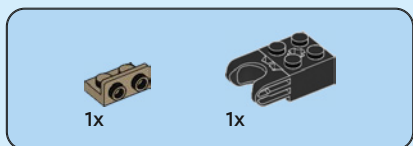
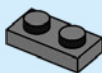

1x

1x

50

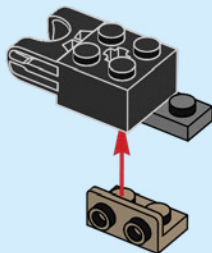

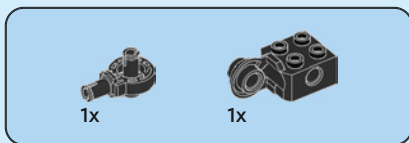

51

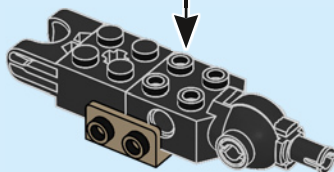
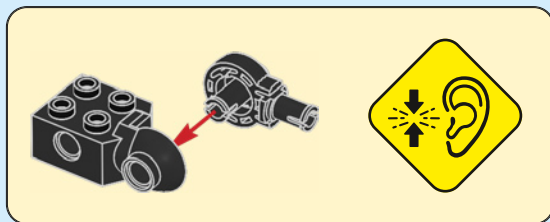



1x



1x

52

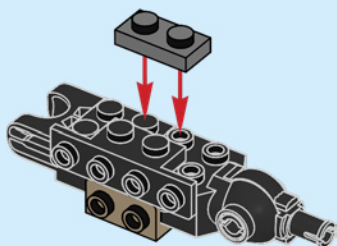

2x

53

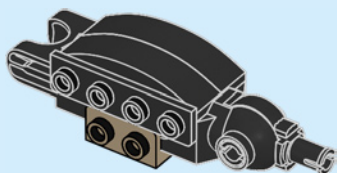

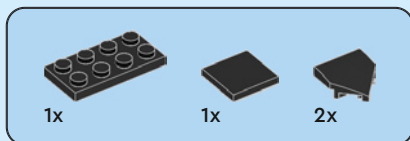

54

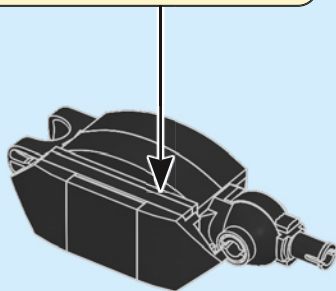
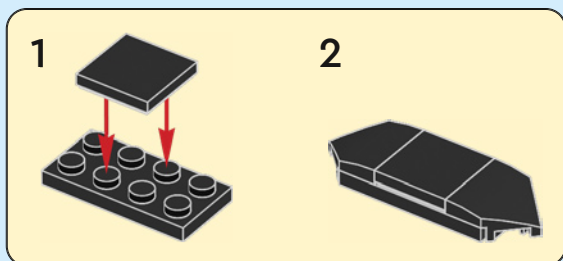



2x

55

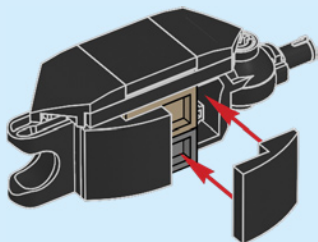

56

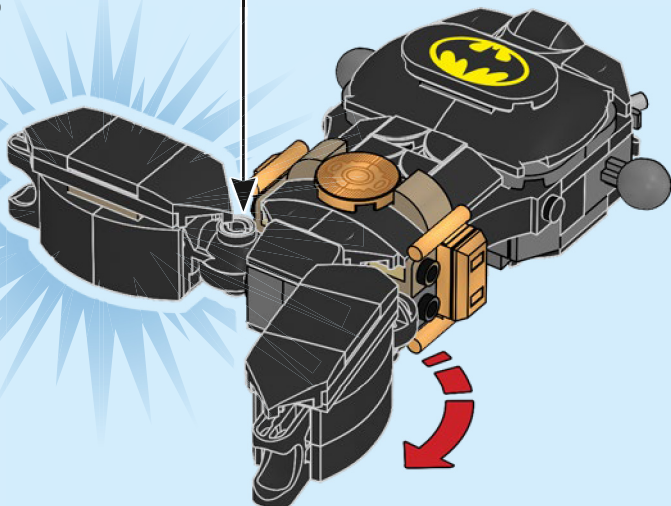



2x

57

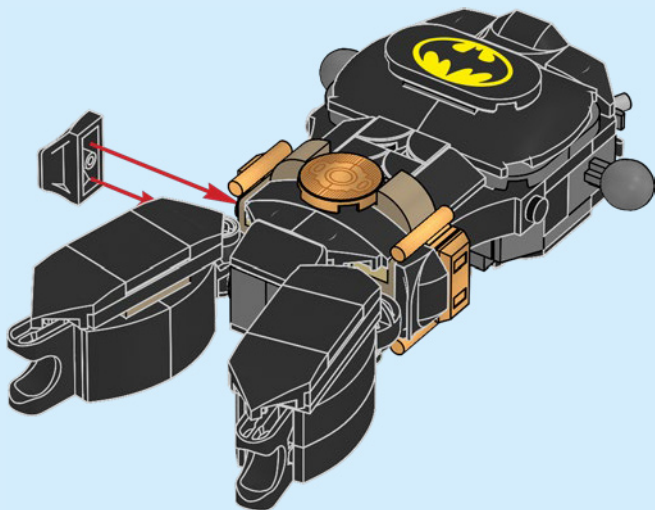



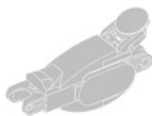

2x



1x



1x

58

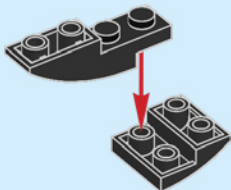

1x

59

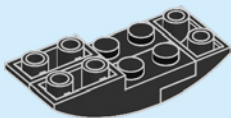

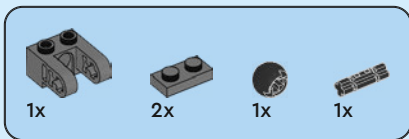

60

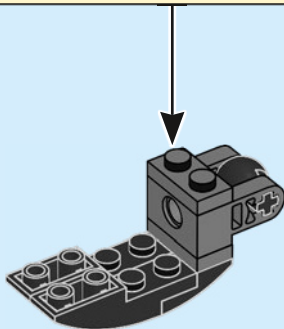
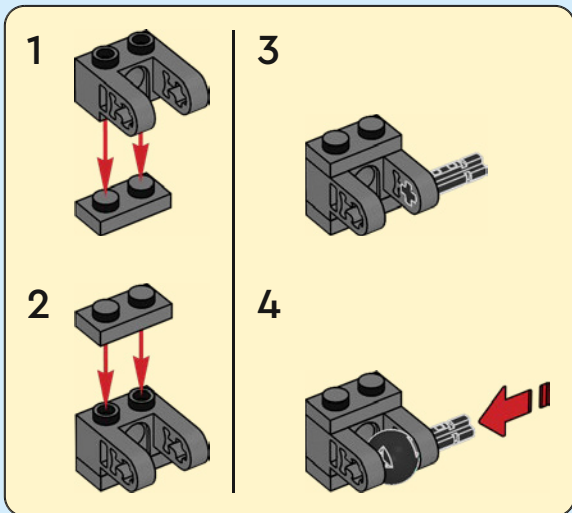



2x

61

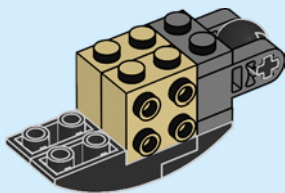

1x

62

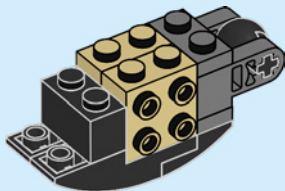



1x

63

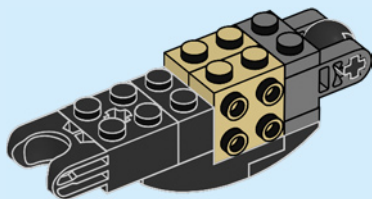

2x

64

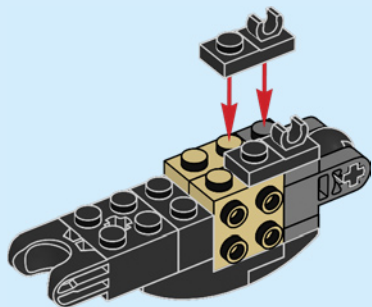



1x

65

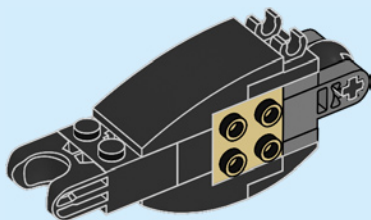

1x

66

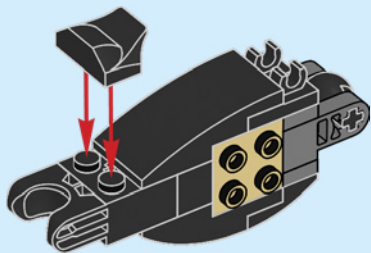

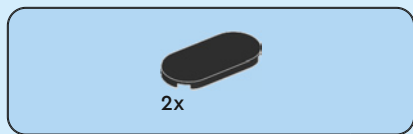

67

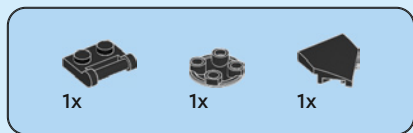
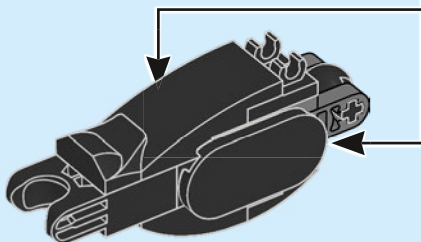

68

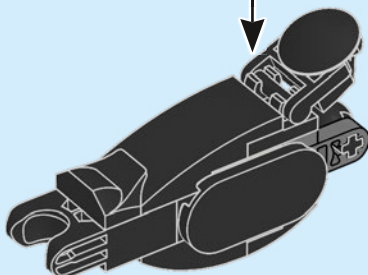
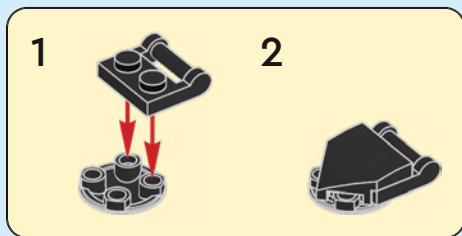

2x

69

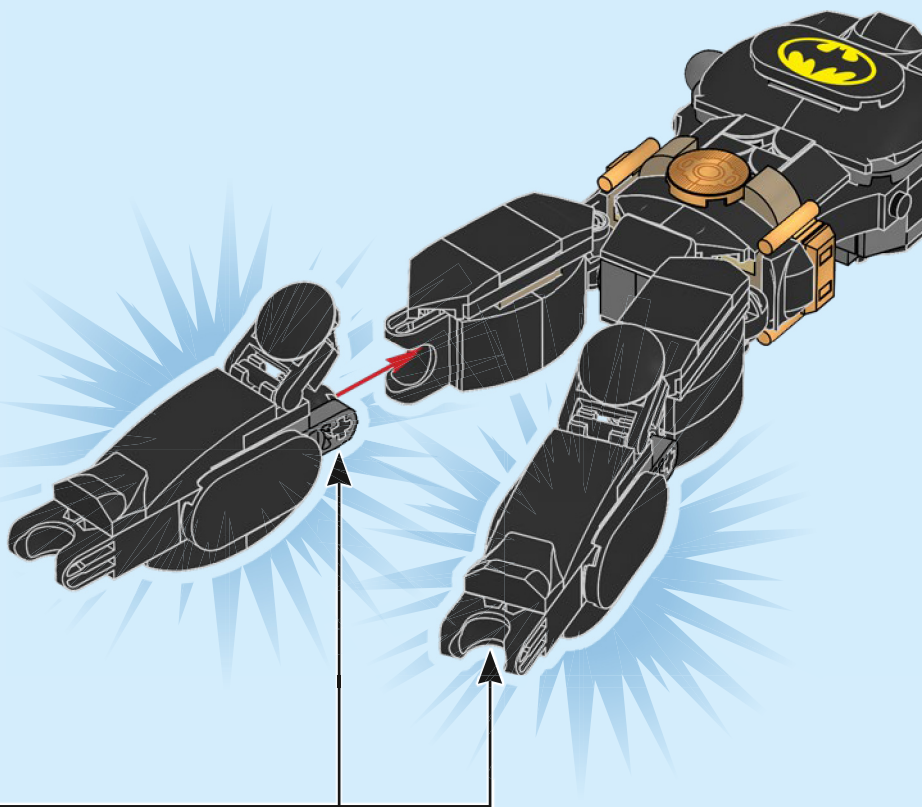



1x



1x

70

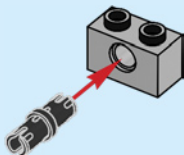

1x

71

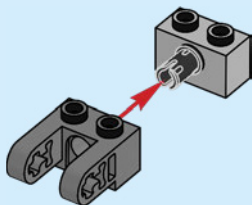



1x

72

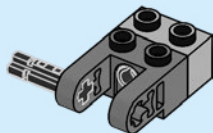

1x

73

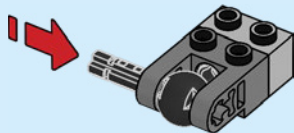



1x

74

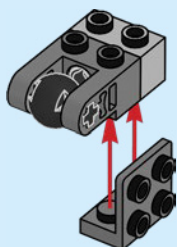

1x

75

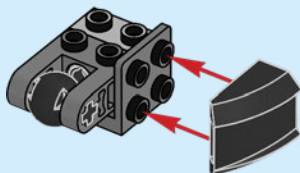



1x

76

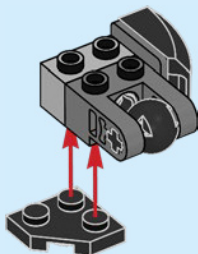

1x

77

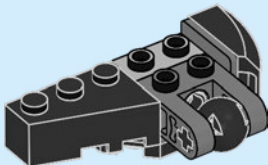



1x



1x

78

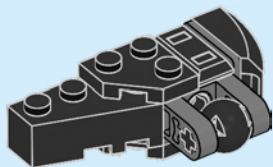

1x

79

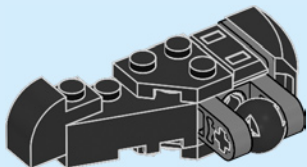



1x

80

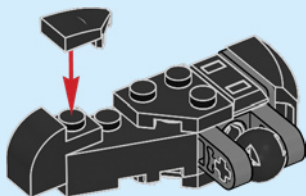

1x



1x



1x

81

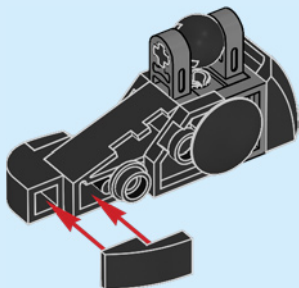

82

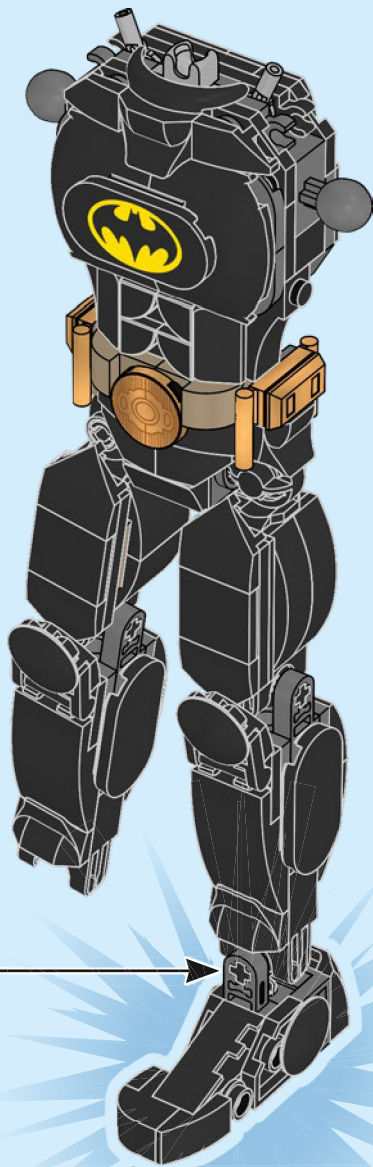



1x



1x

83

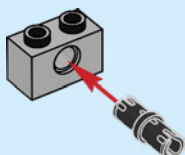

1x

84

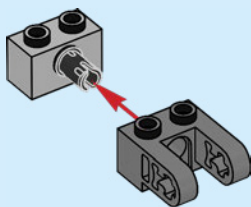



1x

85

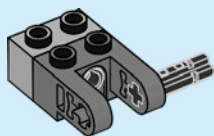

1x

86

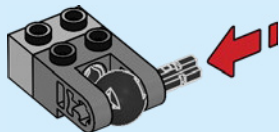



1x

87

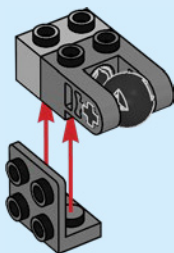

1x

88

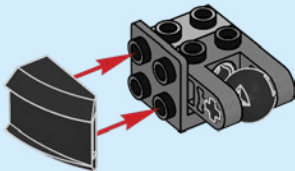



1x

89

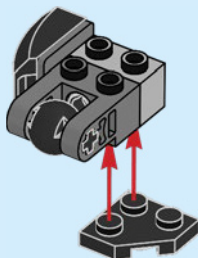

1x

90

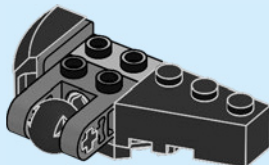

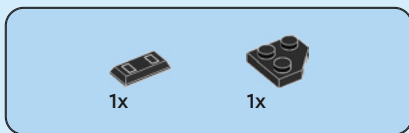

91

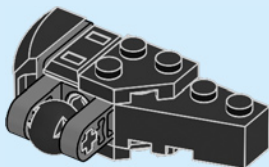

92

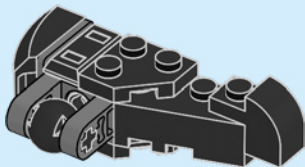



1x

93

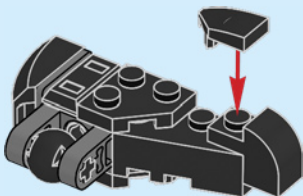

1x



1x



1x

94

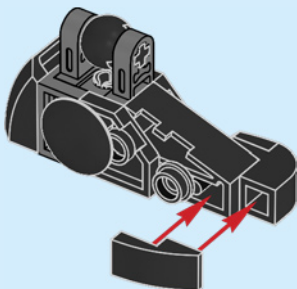

95

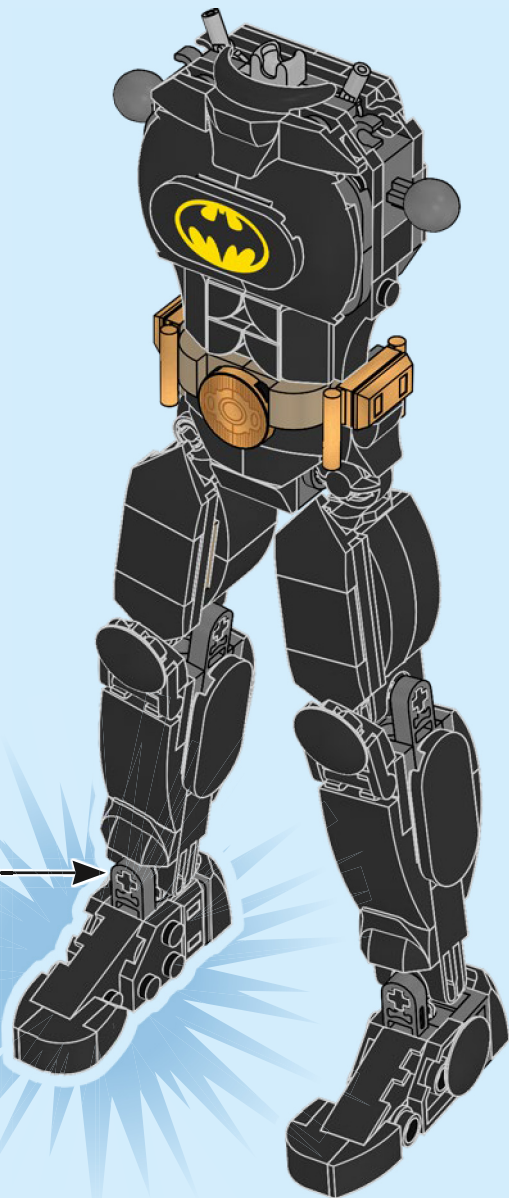



1x



1x

96

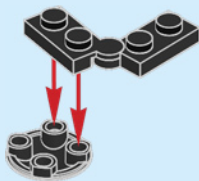



1x

97

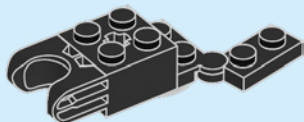

1x

98

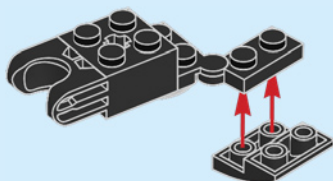



1x



1x

99

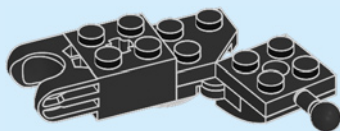

1x

100

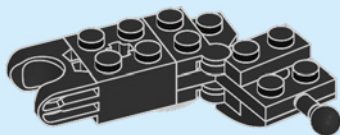

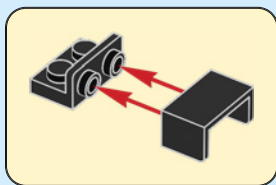
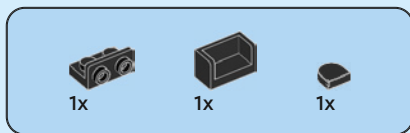

101

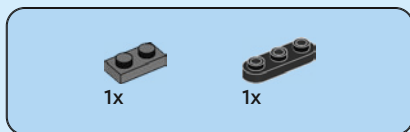
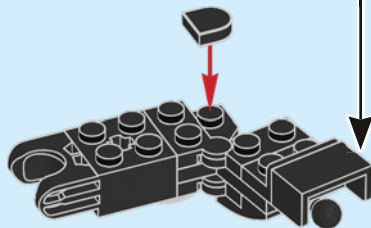

102

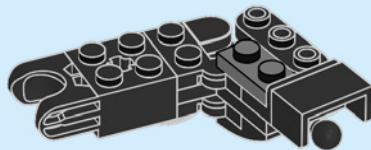

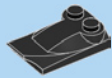

1x



1x

103

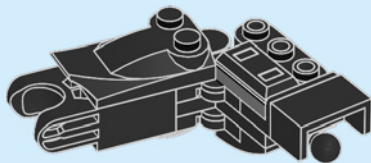

2x



1x

104

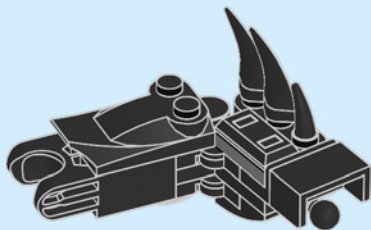

105

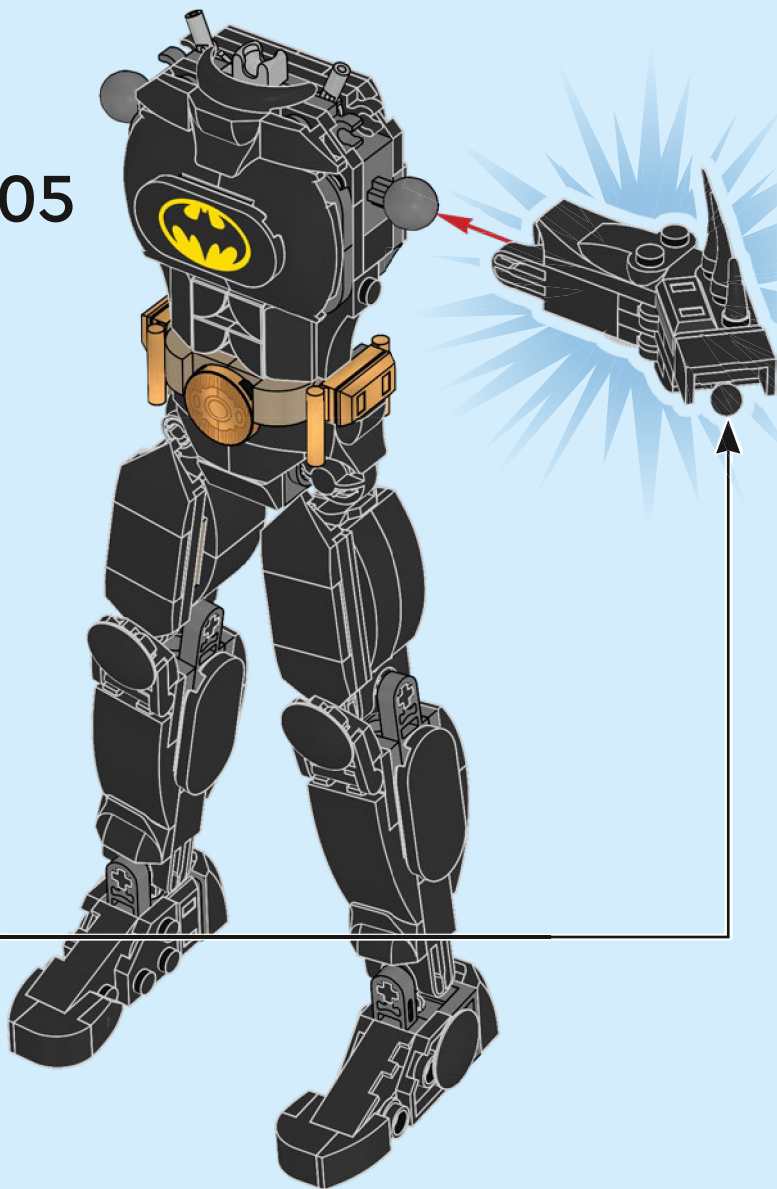

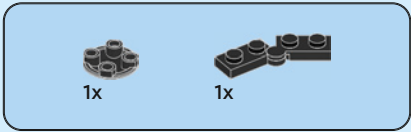

106

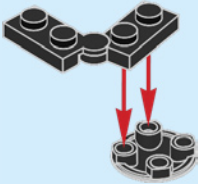



1x

107

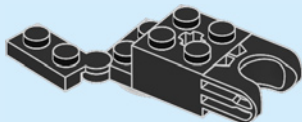

1x

108

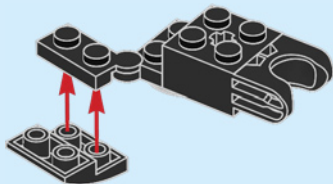



1x



1x

109

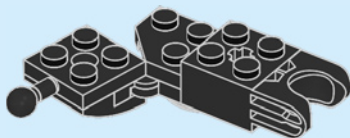

1x

110

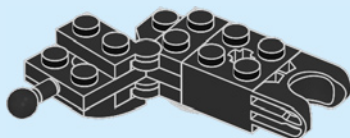

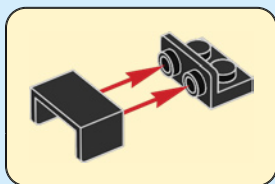
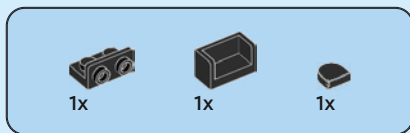

111

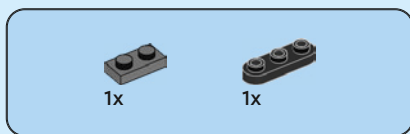
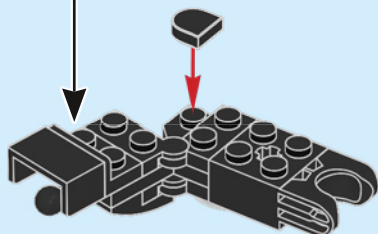

112

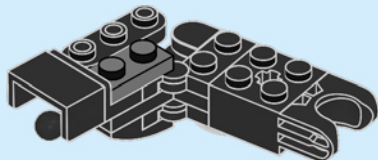

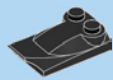

1x



1x

113

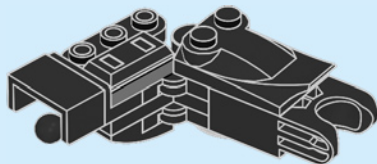

2x



1x

114

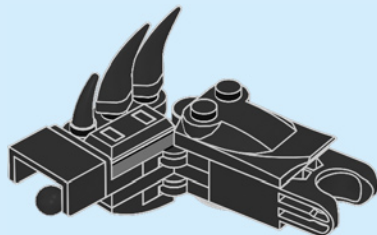

115

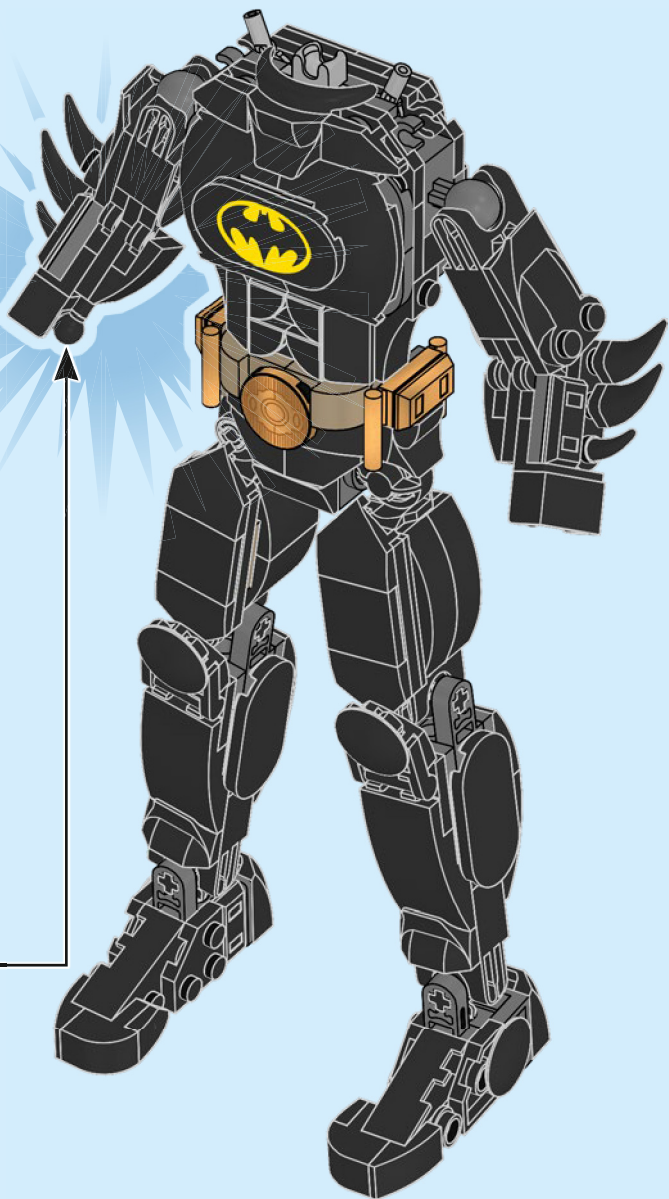



1x



1x

116

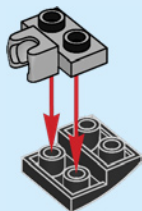

1x



1x

117

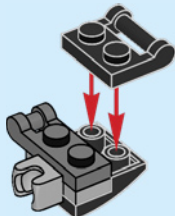



1x

118



4x

119

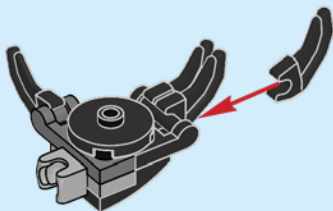

120

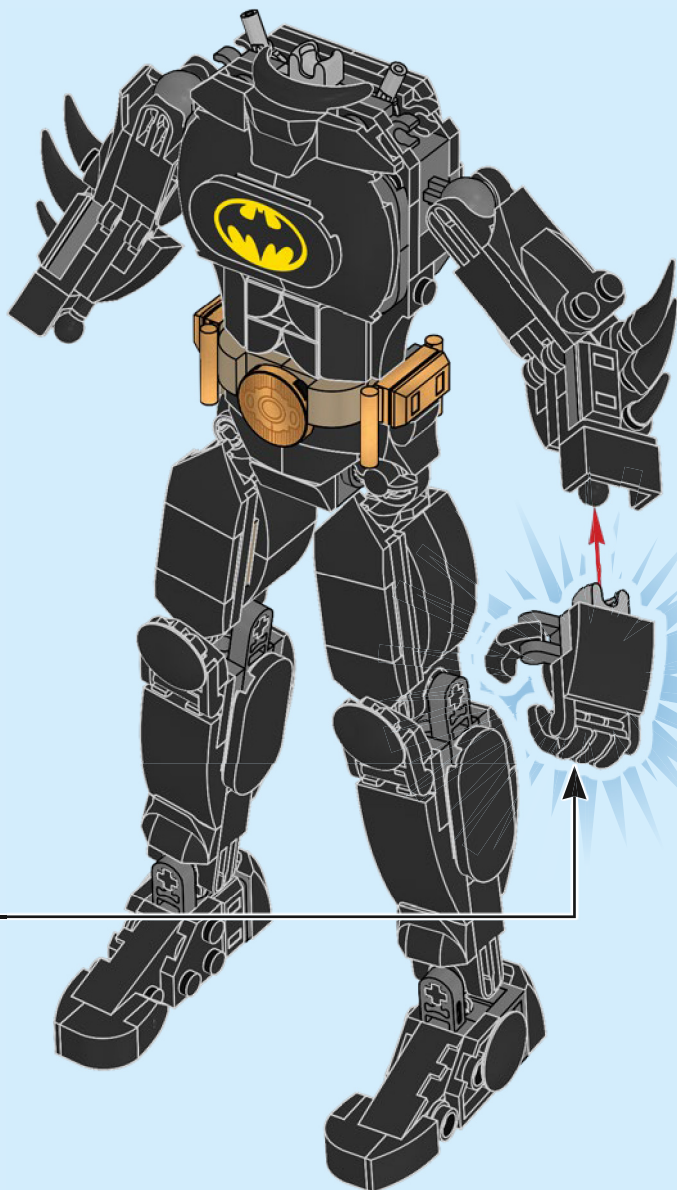

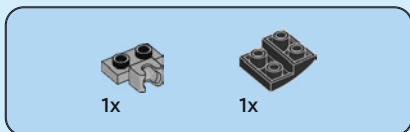

121

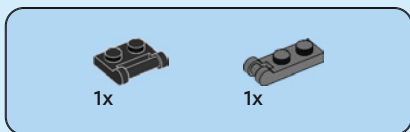
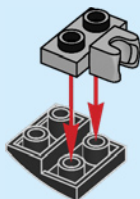

122

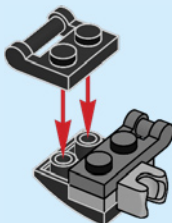



1x

123

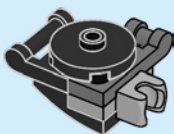

4x

124

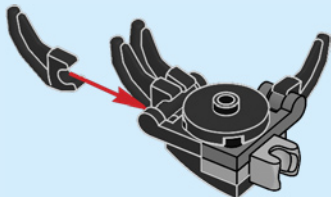

125

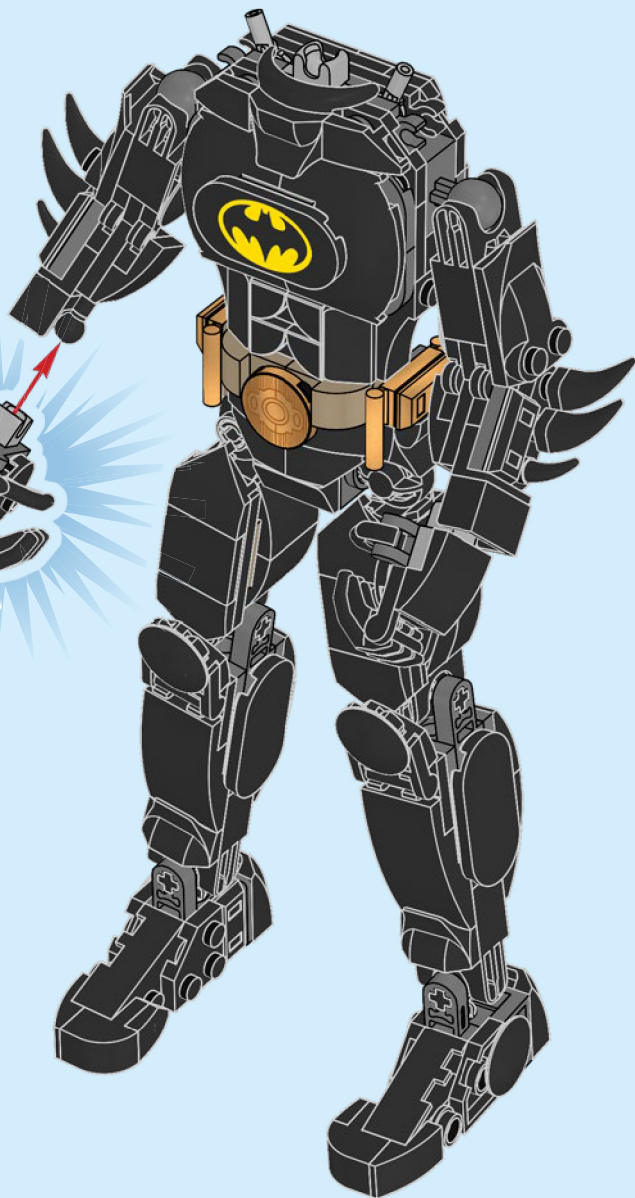

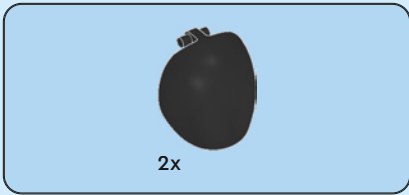

126

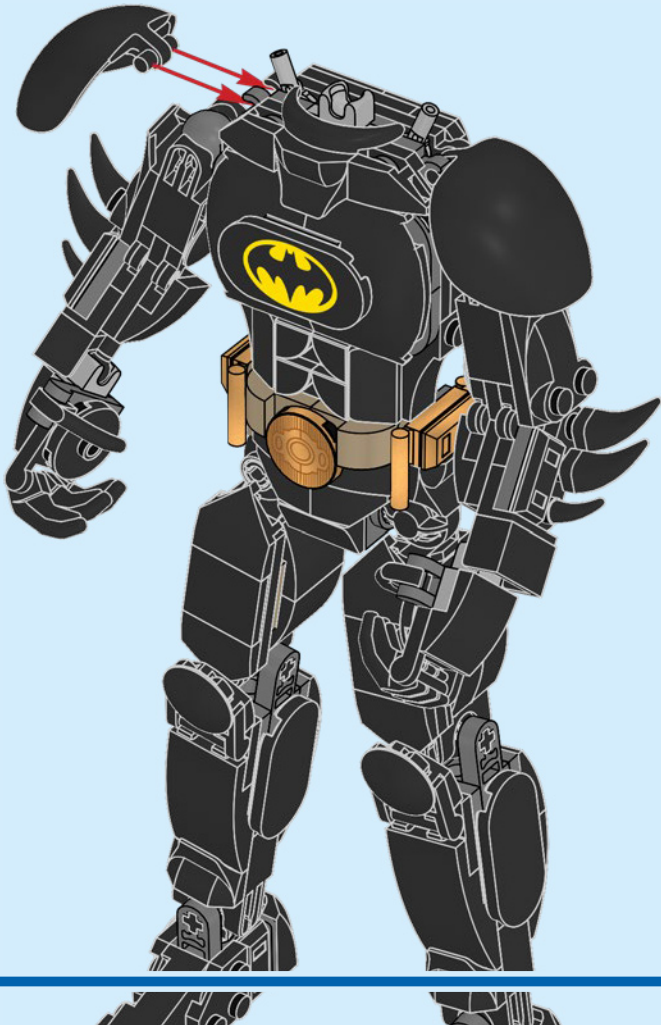

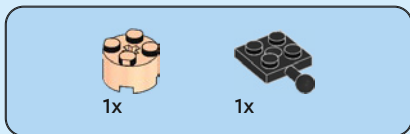

127

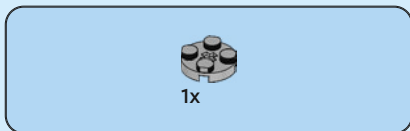
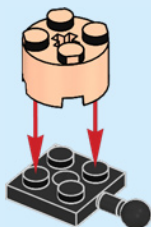

128

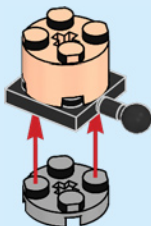

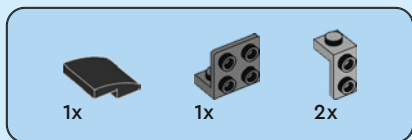

129

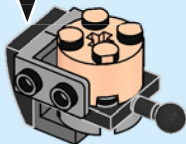
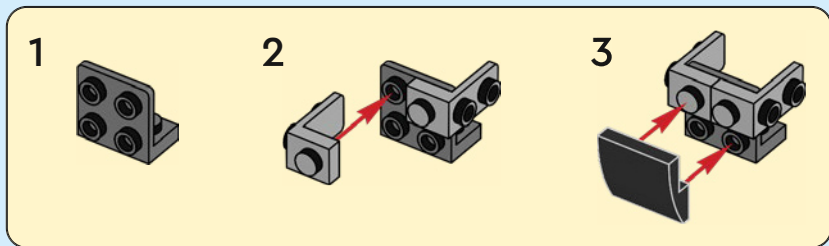



1x



1x



1x



1x

130

1

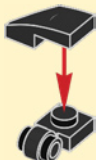

2

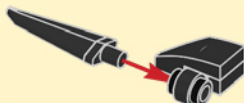

3

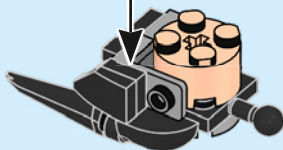
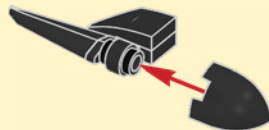



1x



1x

131

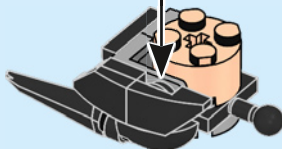
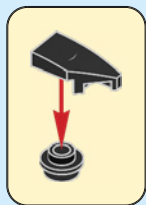



1x



1x



1x



1x

132

1

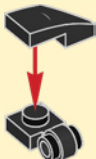

2



3

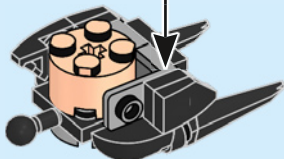
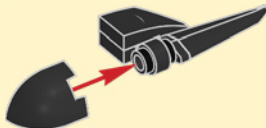



1x



1x

133

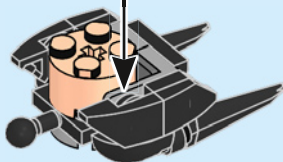
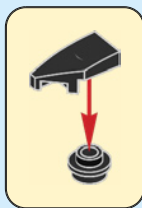

1x

134

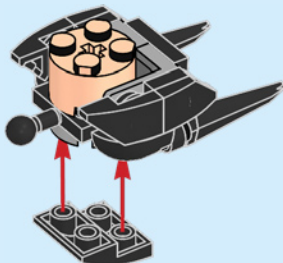

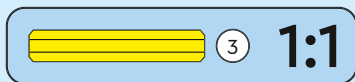
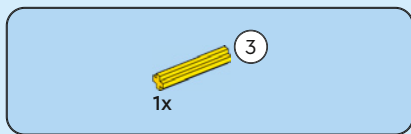

135

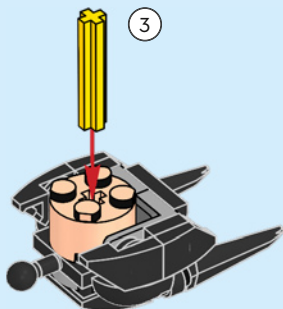

136



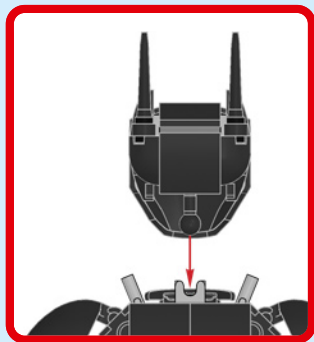

138

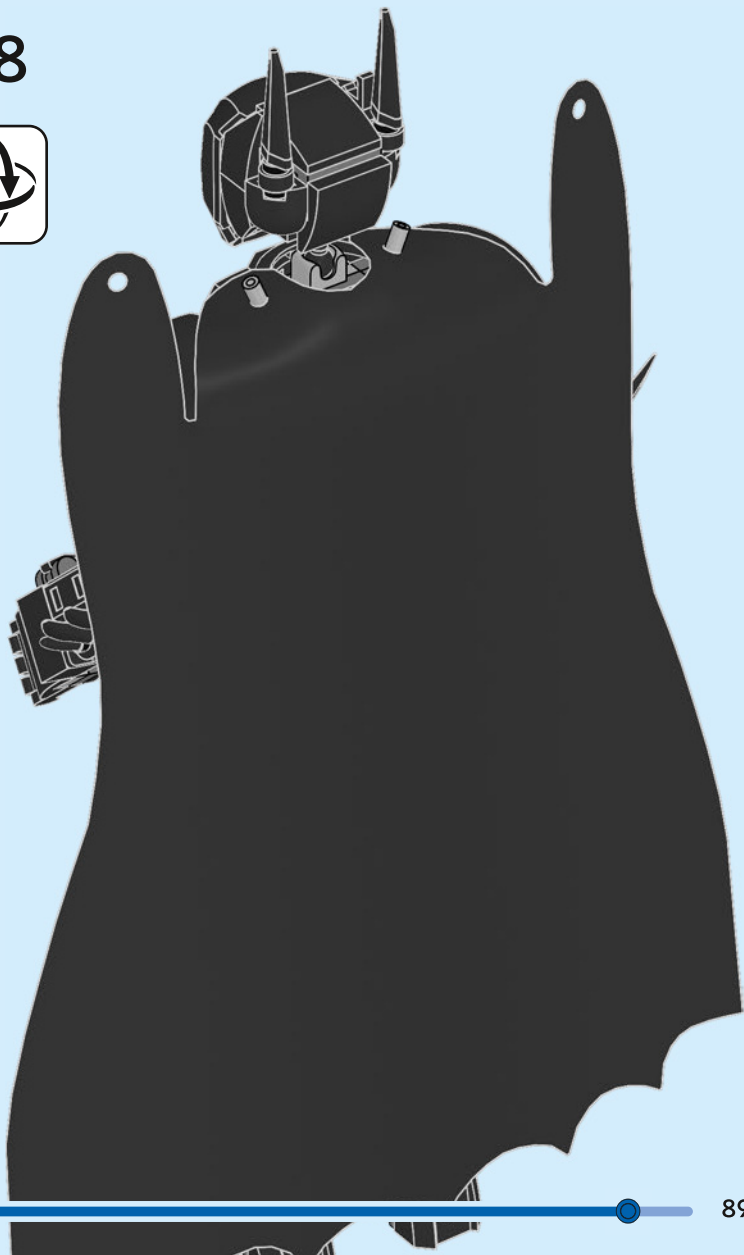

139

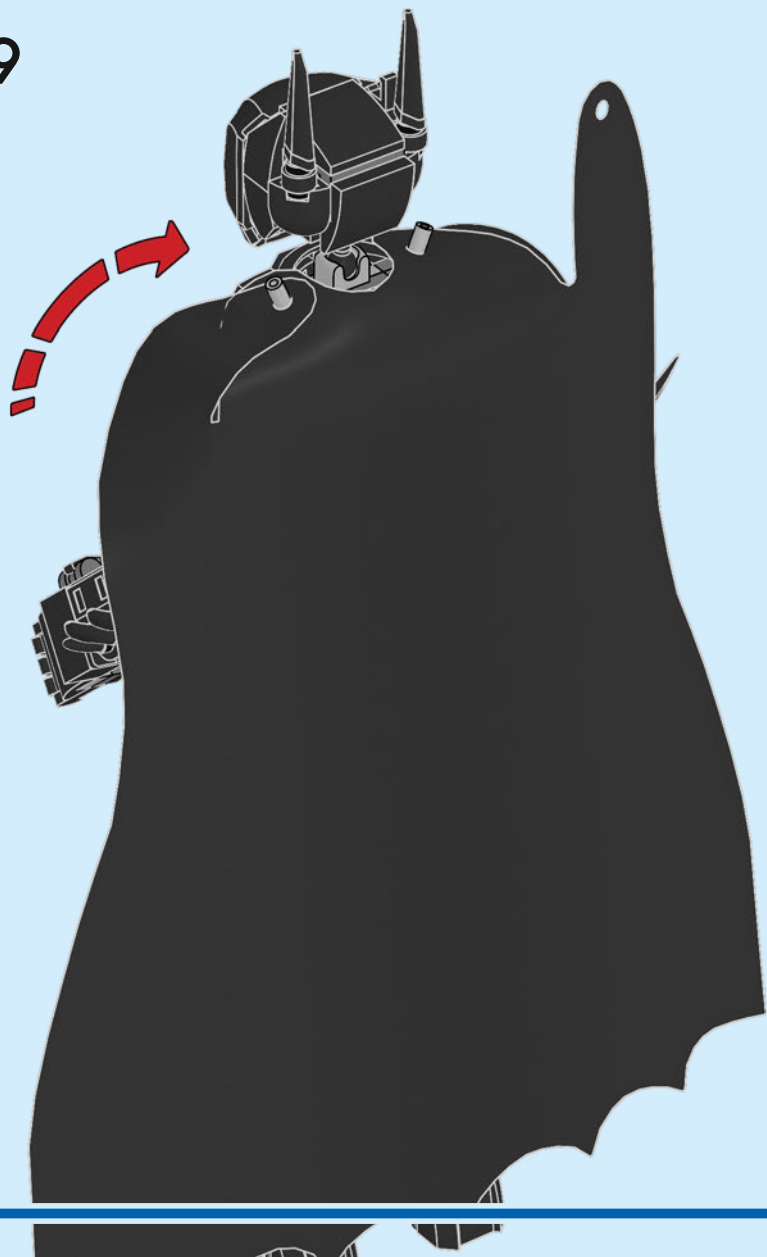

140

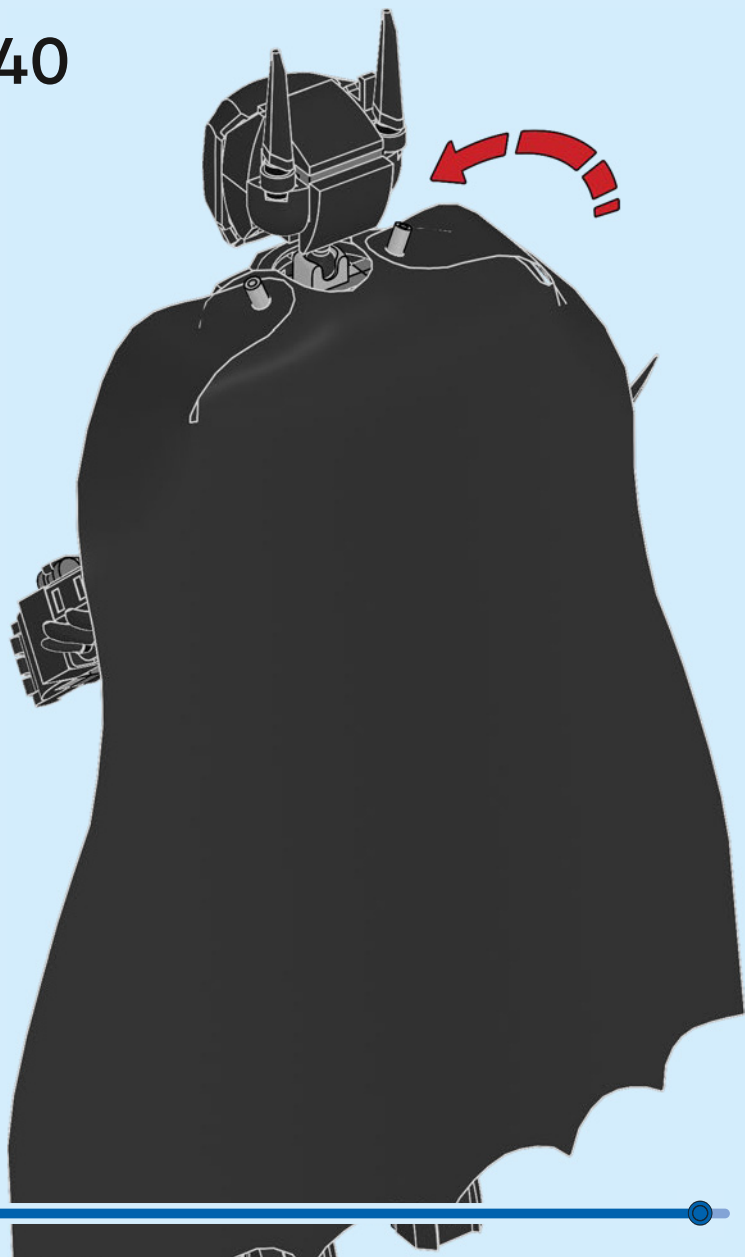



2x

141

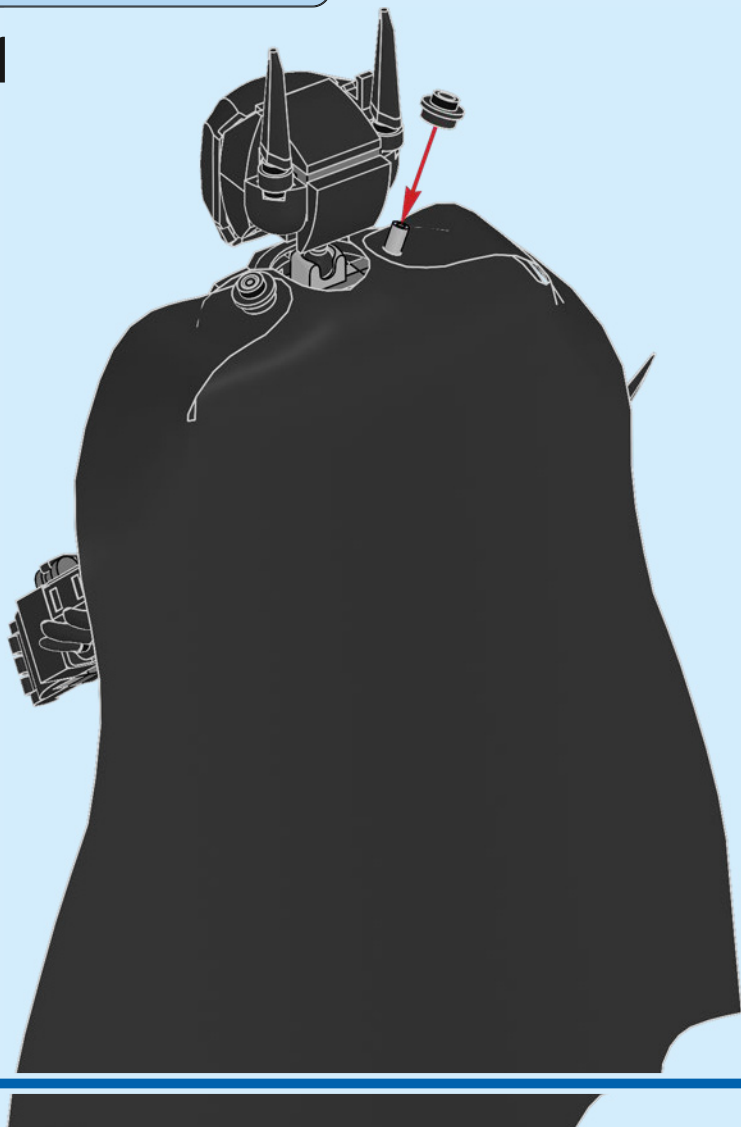



2x
6270103

6x
6168646

2x
6256435

4x
6270091

4x
4286267

4x
6172383

8x
6420198

5x
6181720

2x
6436425

5x
6181713

3x
4548180

6x
4278359

2x
6279875

4x
4109810

2x
6281993

2x
6195325

10x
6174243

2x
6248496

4x
6156991

5x
6375706

6x
6308912

2x
300426

4x
6347310

2x
6184784

2x
6147050

2x
6020193

2x
6428168

4x
4225201

2x
6350725

2x
4213374

16x
6211476

2x
235726

1x
6013867

2x
306826

1x
6053077

2x
4143875

3x
6448318

2x
6270085

2x
6328095

1x
4526931

2x
6432392

1x
6255875

2x
6168620

1x
4531412

2x
302126

1x
4527766

1x
6444157

4x
6331483

2x
4285883

1x
6438248

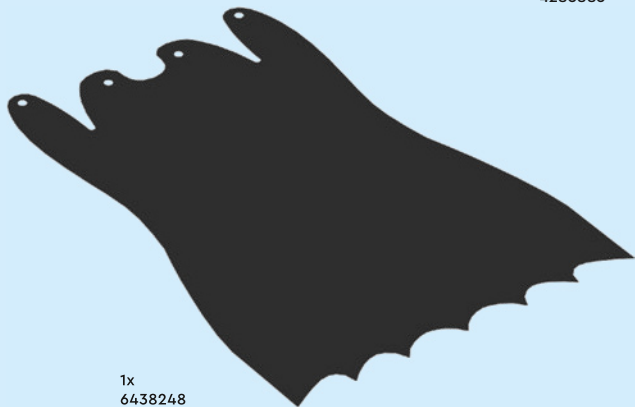



5x
4613153



4x
6039869



6x
6360825



2x
6302828



4x
6416444



2x
6386234



2x
4647286



2x
302026



2x
4188534



1x
6444156



2x
6350415



2x
379526



2x
4210633



4x
4211044



2x
4504378



2x
6336390



2x
6296892



11x
4211063



2x
6398662



2x
6214341



3x
6308045



4x
4211094



4x
6411395



2x
4521187



4x
6324639



3x
4497253



1x
4243831



2x
6362975



2x
6227897



1x
4211475



3x
6043656



2x
4211440



2x
6360295



4x
6250168



4x
6214334



2x
4114077



1x
371021



1x
6422920



1x
6357786



1x
6444158



2x
6207933



2x
6337403



2x
302324



1x
6130007



1x
6360826



LEGO.com/service

YOU COULD

WIN



Scan this QR code or go to **LEGO.COM/PRODUCTFEEDBACK** and give us your short feedback about this LEGO® set for a chance to win a cool LEGO prize.

Terms and Conditions apply*

EN: YOU COULD WIN. Terms and Conditions apply* **DE: Du könntest GEWINNEN.** Es gelten die Teilnahmebedingungen* **FR: Tu pourrais GAGNER.** Des conditions s'appliquent* **IT: Potresti VINCERE tu.** Termini e condizioni sono applicabili* **ES: Puedes GANAR.** Aplican términos y condiciones* **PT: Poderá GANHAR.** Aplicam-se termos e condições* **ZH: 轻松获奖. 条款和条件适用*** **PL: Szansa na WYGRANĄ.** Obowiązują warunki korzystania* **CS: Máte šanci VYHRÁT.** Platí všeobecné smluvní podmínky* **SK: Máte šancu VYHRAŤ.** Platia všeobecné zmluvné podmienky* **HU: TE IS NYERHETSZ.** Felhasználási feltételek érvényesek* **RO: Ai putea CÂȘTIGA.** Se aplică termeni și condiții* **BG: Можете да СПЕЧЕЛИТЕ.** Има определени правила и условия* **LV: Tu vari LAIMĒT.** Ir spēkā noteikumi un nosacījumi.* **ET: Sul on võimalus VÕITA.** Kehtivad tingimused* **LT: Jūs galite LAIMĖTI.** Taikomos sąlygos*

*[LEGO.com/productfeedback-terms](https://www.lego.com/productfeedback-terms)

LEGO and the LEGO logo are trademarks of the LEGO Group. ©2023 The LEGO Group. BATMAN RETURNS and all related characters and elements © & ™ DC and Warner Bros. Entertainment Inc. WB SHIELD: © & ™ WBEI (s23)

6467929