



Spare Parts

 www.argos-support.co.uk

 Help@ClickSpares.co.uk

 0370 112 1928

Customer Support

 0345 640 2020



Safety and Care Advice

Product Details

3080216 (commode)

IMPORTANT, RETAIN FOR FUTURE REFERENCE: READ CAREFULLY.

- Keep children and animals away from the work area, small parts could choke if swallowed.
- Make sure you have enough space to layout the parts before starting.
- This product has been constructed to be used in the domestic environment only and not for commercial purposes.
- Assemble the item as close to its final position (in the same room) as possible.
- Assemble on a soft level surface to avoid damaging the unit or your floor.
- We do not recommend the use of power drill/drivers for inserting screws as this could damage the unit. Only use hand screwdrivers.
- Parts of the assembly will be easier with 2 people.
- Dispose of all packaging carefully and responsibly.

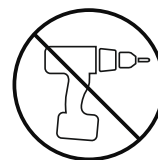

Care and maintenance

- Only clean using a damp cloth and mild detergent. Do not use abrasive cleaners.
- Use a dry cloth to clean the product, furniture polish is not recommended.
- From time to time check that there are no loose screws, nuts or bolts. If there are please re-tighten.
- This product should not be discarded with household waste. Take to your local authority waste disposal centre.

Additional Guidance

- Assemble all parts and bolts loosely during assembly, only once the product is complete should you fully tighten the bolts.
- Regularly check and ensure that all bolts and fittings are tightend properly.
- Maximum user weight 25kg
- This product is compliant BS 4875-7; EN 14749

ANTI-TOPPLE WARNING!

This product has to be permanently fixed to the wall with the bracket(s) included, to avoid fatal injury in case it topples over. The pack only contains screws for fastening the anti-topple bracket(s) itself to the product. Please contact your DIY or hardware store for advice on the correct type of screws/raw plugs for your type of wall.

Fittings (Shown to scale)

Bag 1



A \varnothing 8x35 Wooden Dowel x 64



B \varnothing 3x20 mm Screw x 30



C Cam Lock Cap x 12



D Cam Lock x 28

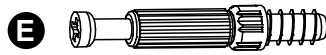

E Metal Cam Screw x 28



F \varnothing 5x13 mm Screw x 20



G \varnothing 4x16 mm Screw x 2

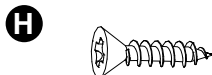

H \varnothing 3x16 mm Screw x 25



I \varnothing 3,5x16 mm Screw x 10

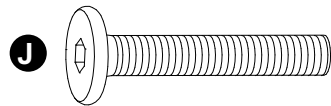

J M6x35 mm Screw x 4

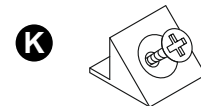

K Plastic Wedge x 12



L \varnothing 20x2 mm Felt pad x 4

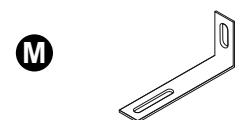

M Wall bracket x 2

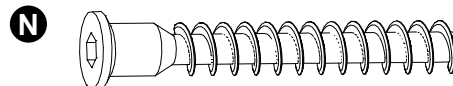

N \varnothing 7x50 mm hexagon bolt x 14

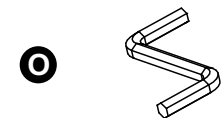

O Allen Key x 1



P \varnothing 10 mm cap x 1



Q Push-catch bumper x 5

Hardware

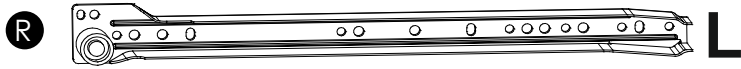

Drawer guide (panel side) x 5

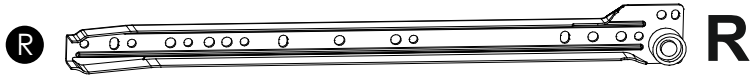

Drawer guide (panel side) x 5

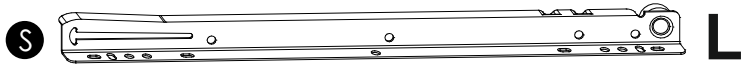

Drawer guide (drawer side) x 5

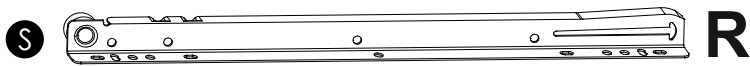

Drawer guide (drawer side) x 5



L-150 mm Wooden Leg x 4

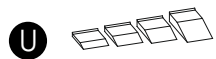

Height adjuster wedges set x 1

Tools required

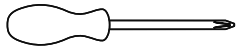

Phillips screwdriver
(small & medium)

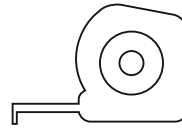

Ruler/tape
measure



Phillips screwdriver
(small & medium)

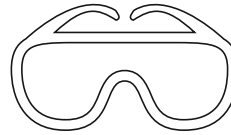

Eye protection
(when using a
hammer or glue)



Small
hammer



Pencil

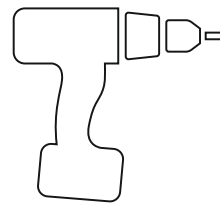

Power Drill

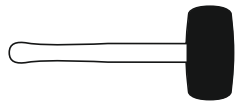

Mallet



Spirit Level

Panels

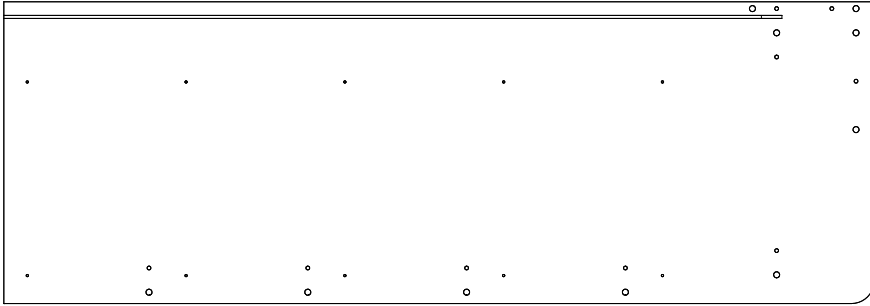

1 Left side x 1 (115x40cm)

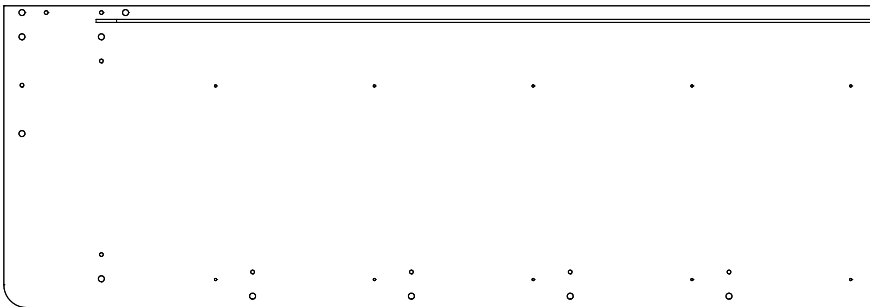

2 Right side x 1 (115x40cm)

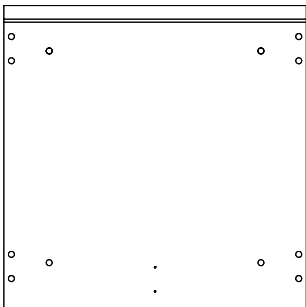

3 Bottom panel x 1 (40x40cm)

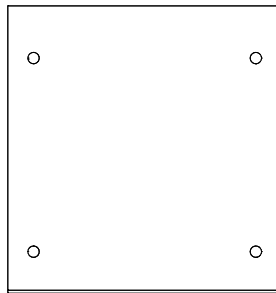

4 Top panel x 1 (36x38cm)

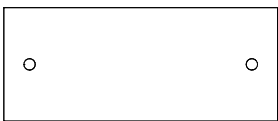

6 Top shelf x 1 (36x15cm)



7 Construction slat x 4 (36x6cm)



9 Drawer right side x 5 (37x12cm)



10 Drawer back x 5 (30x12cm)

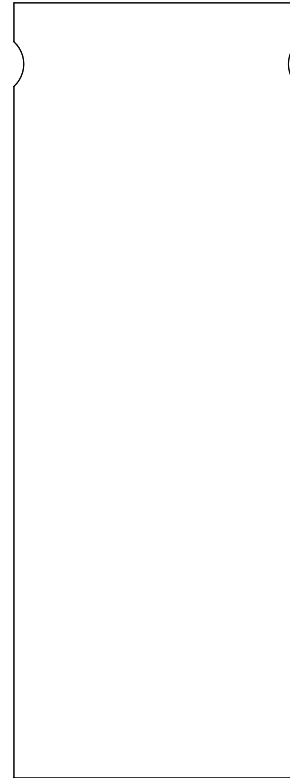

12 Back x 1 (103x38cm)

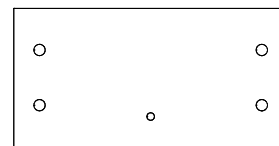

5 Back panel x 1 (36x18cm)



8 Drawer left side x 5 (37x12cm)

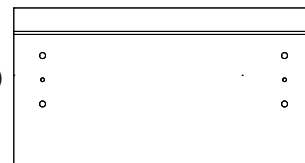

11 Drawer front x 5 (40x21cm)



13 Drawer bottom x 5 (34x38cm)

1

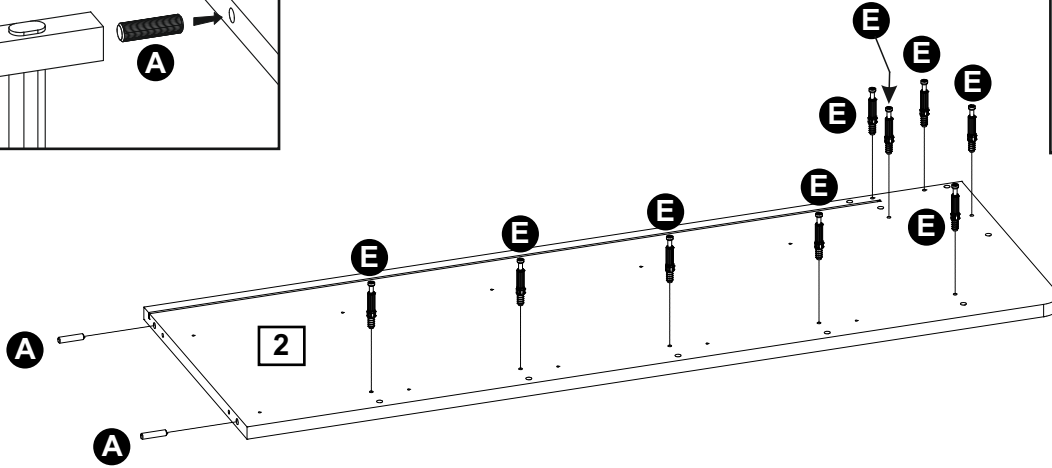
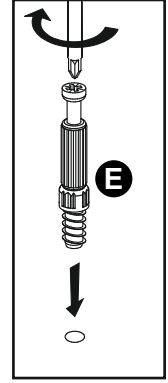
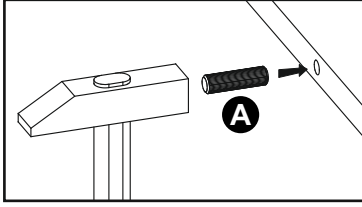
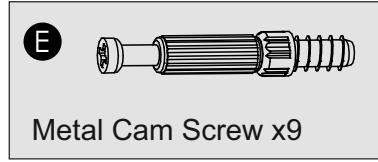
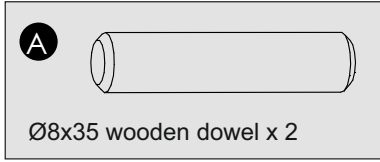

2

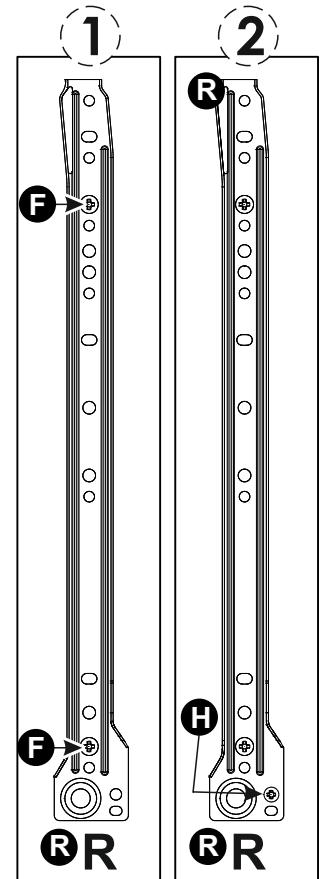
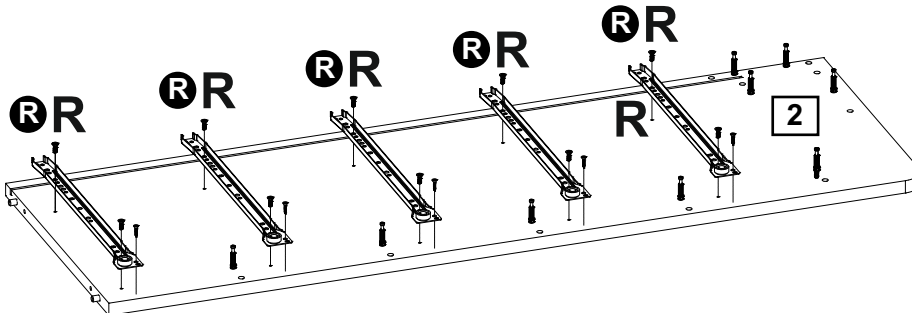
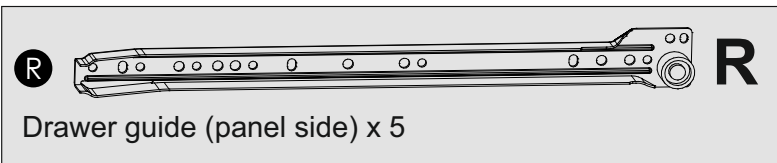
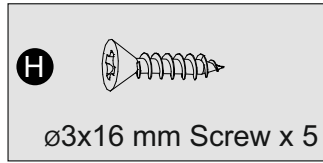

3

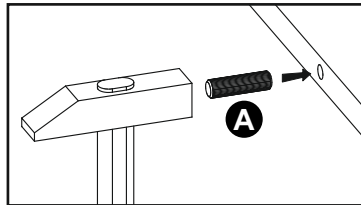
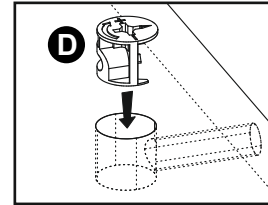
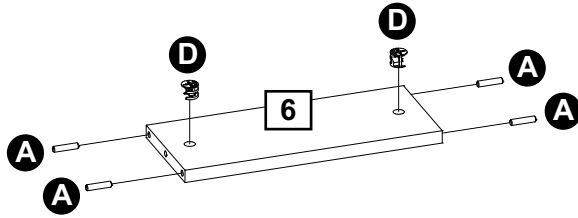
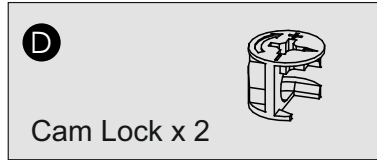
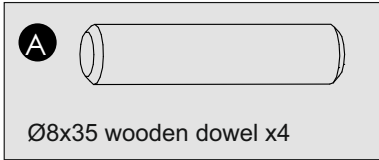

4

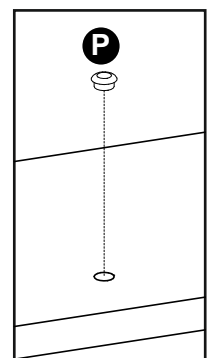
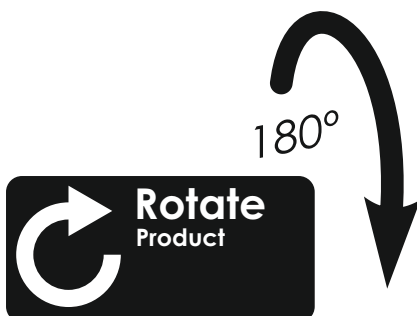
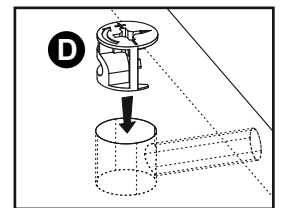
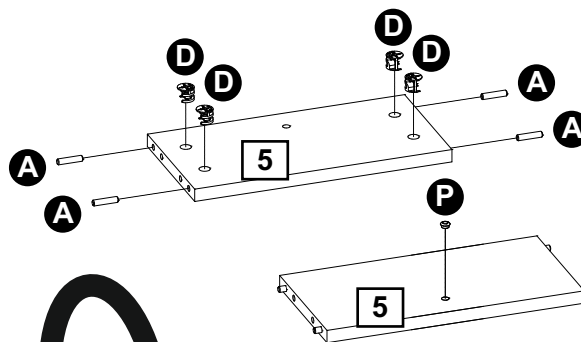
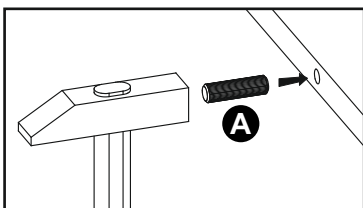
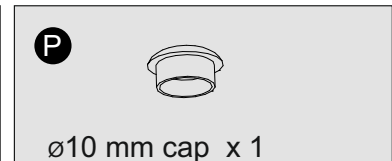
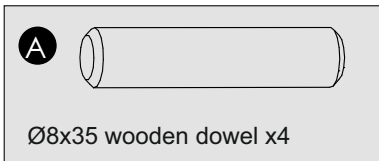

5

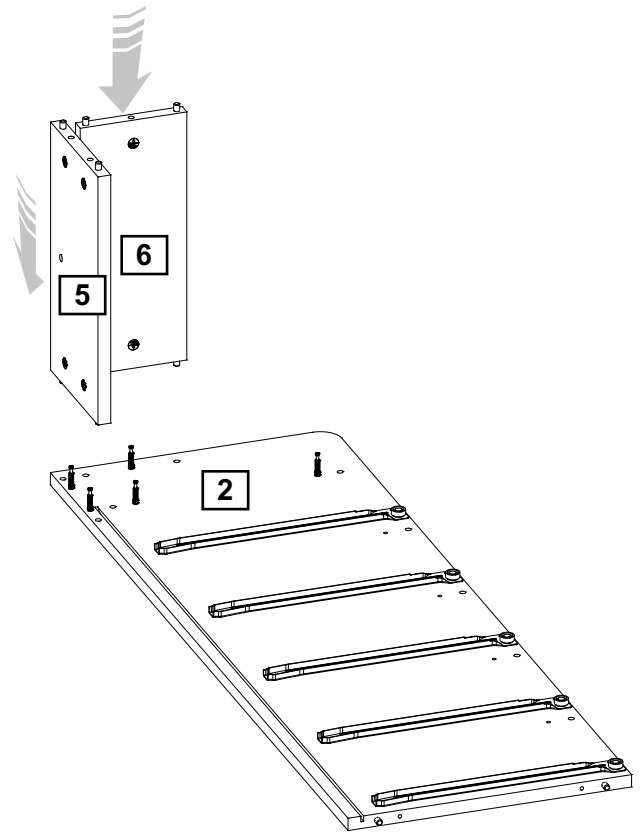
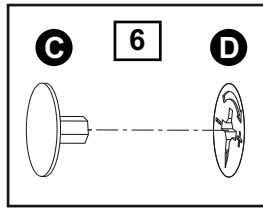
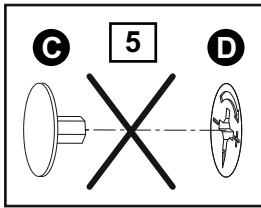
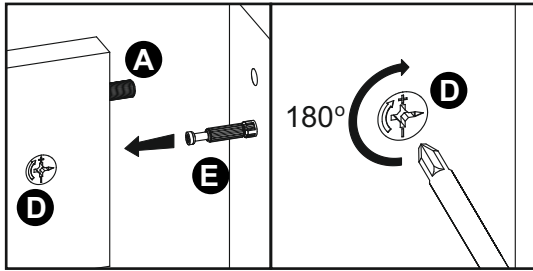
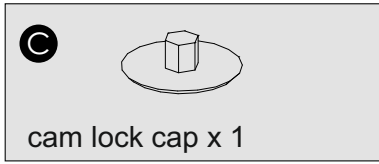

6

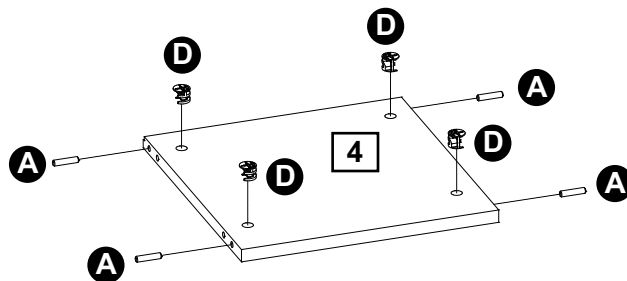
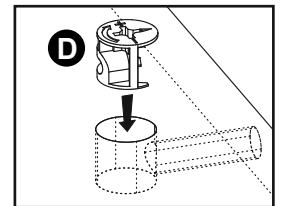
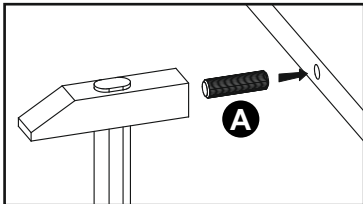
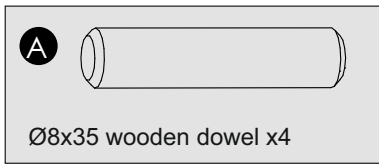

7

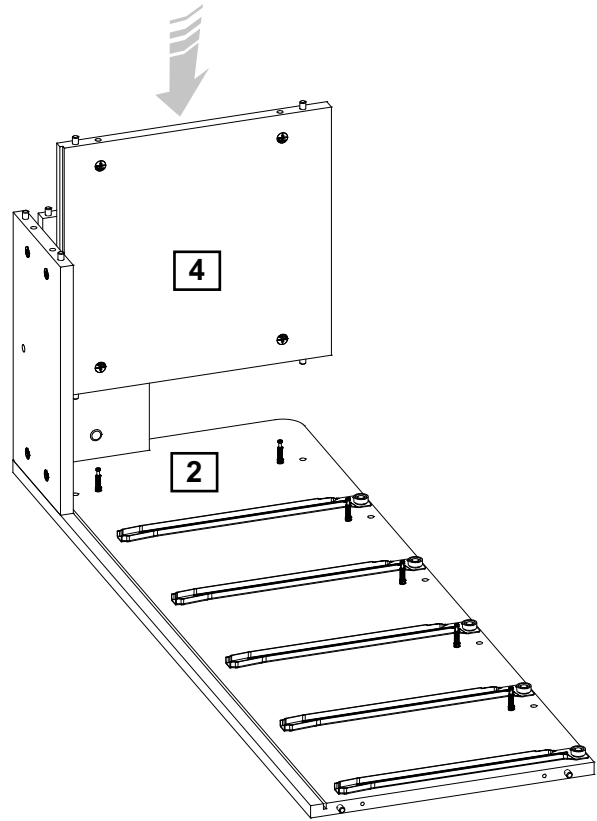
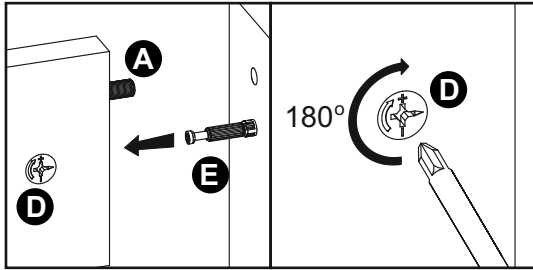

8

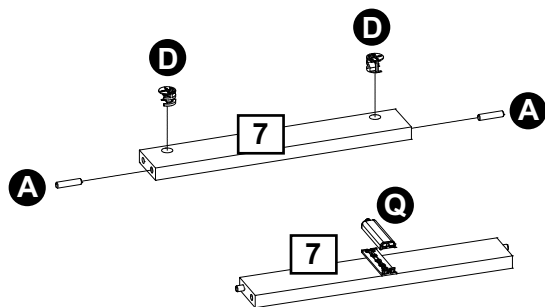
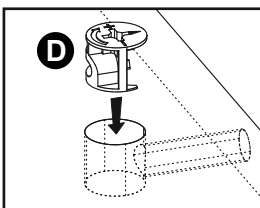
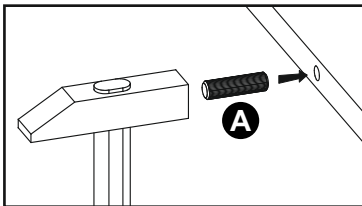
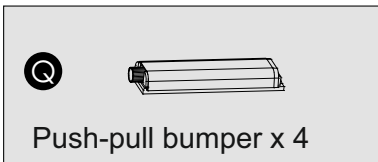
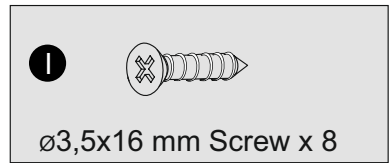
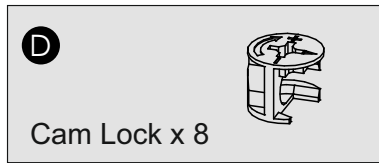
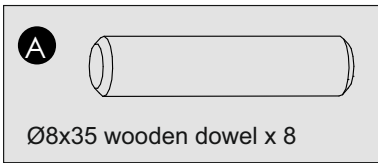

 Repeat x4

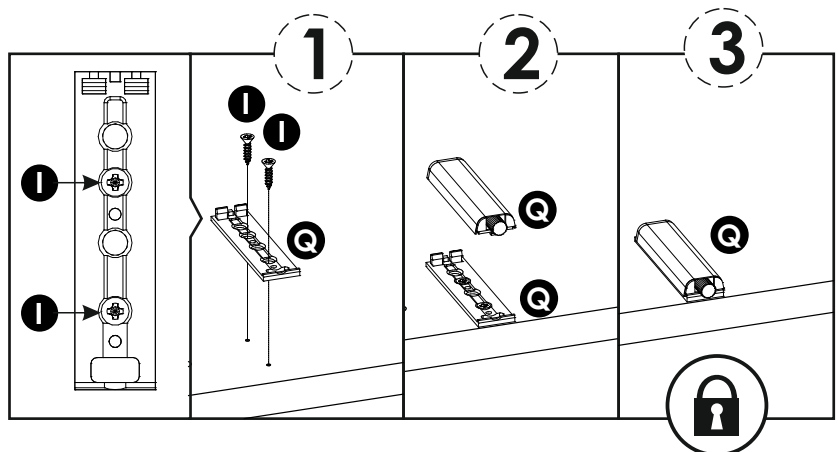

9

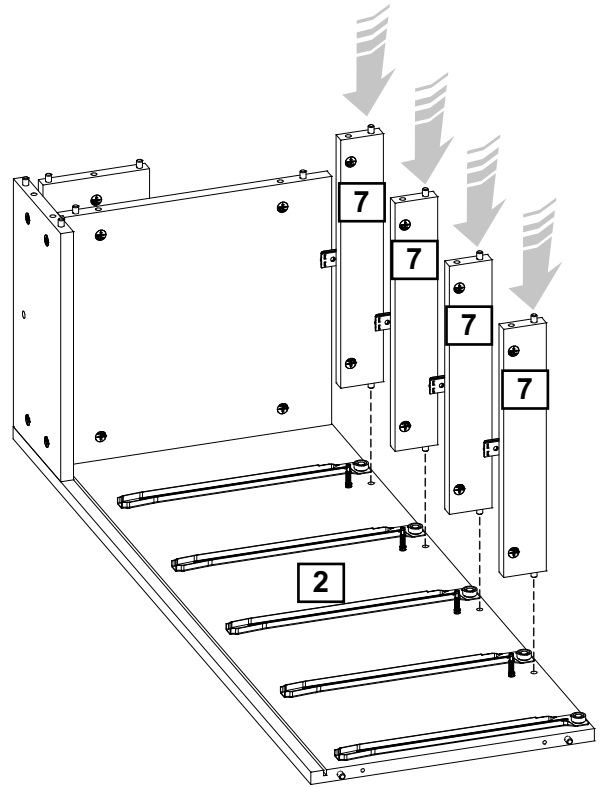
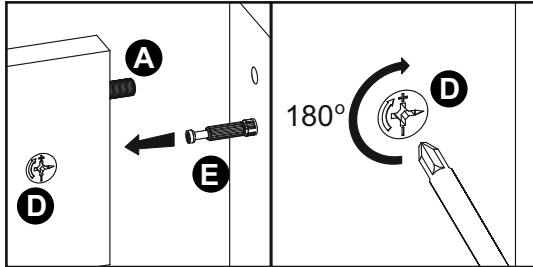

10

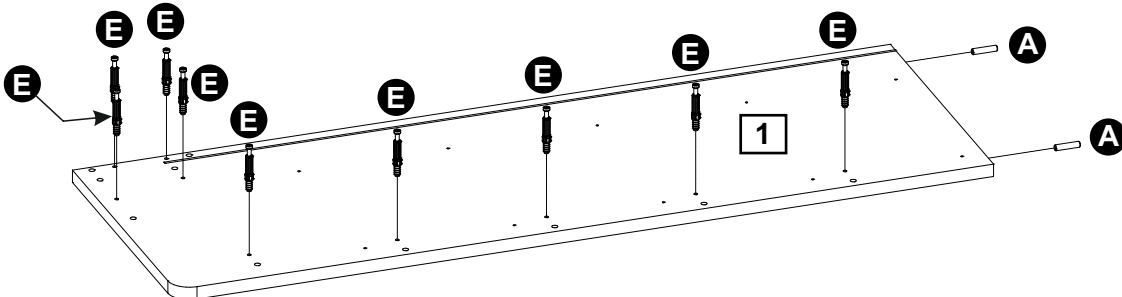
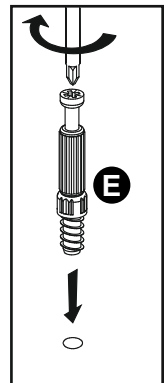
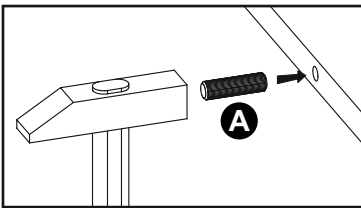
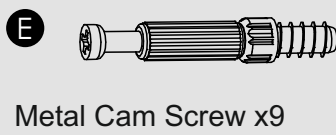
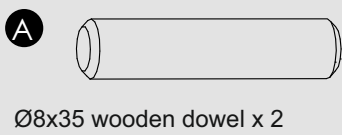

11

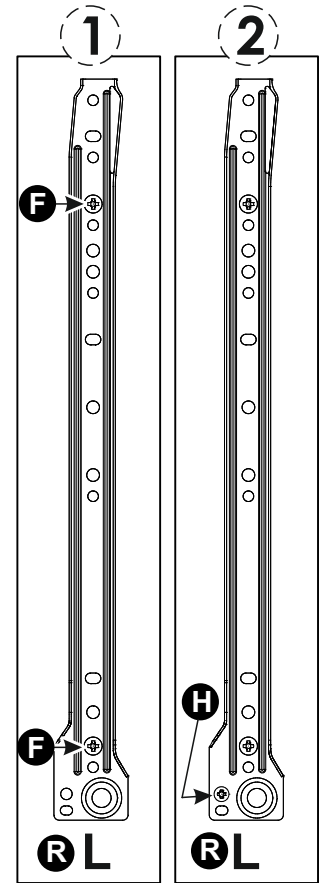
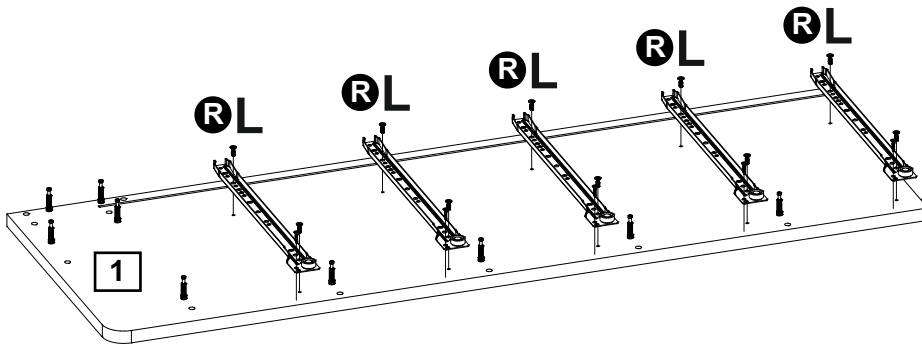
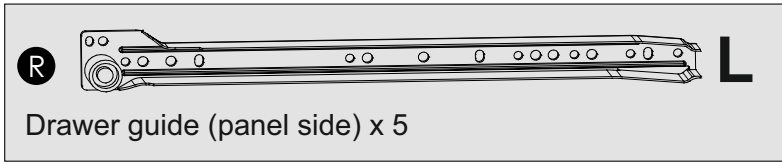
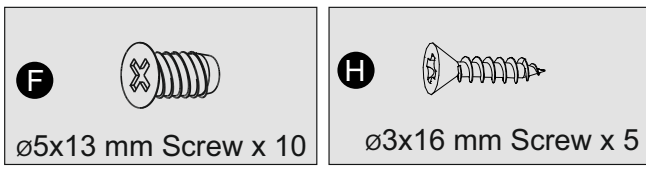

12

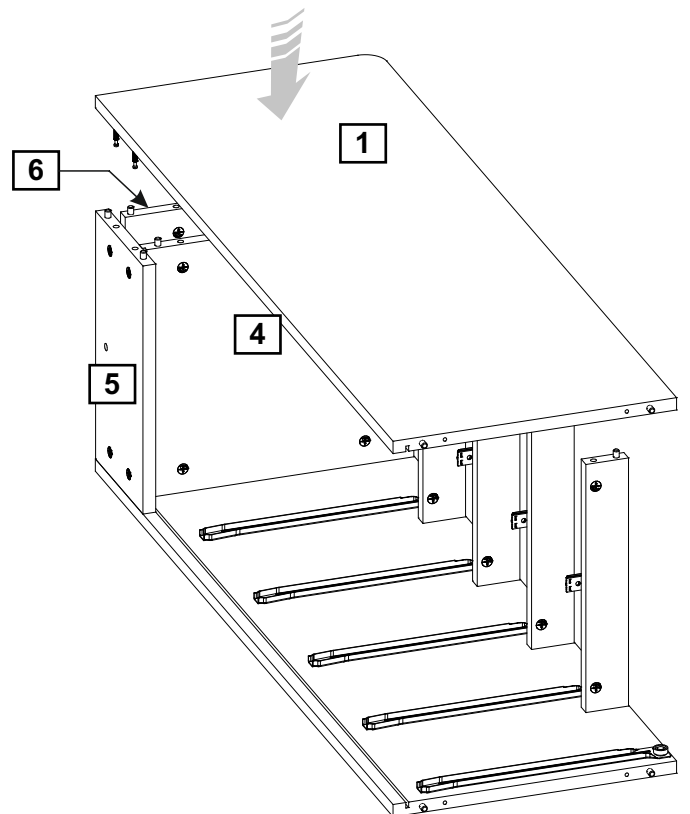
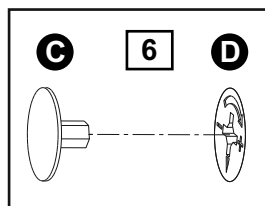
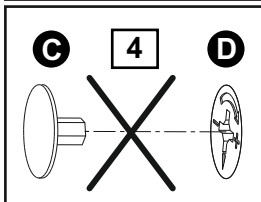
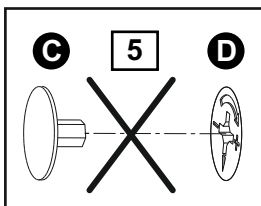
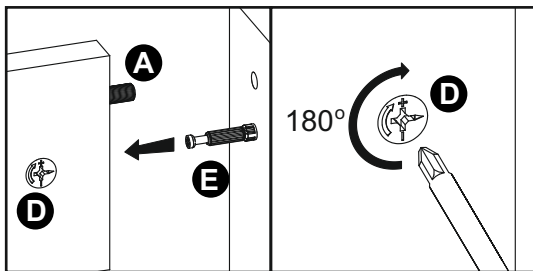
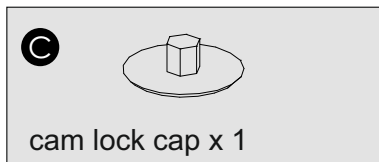

13

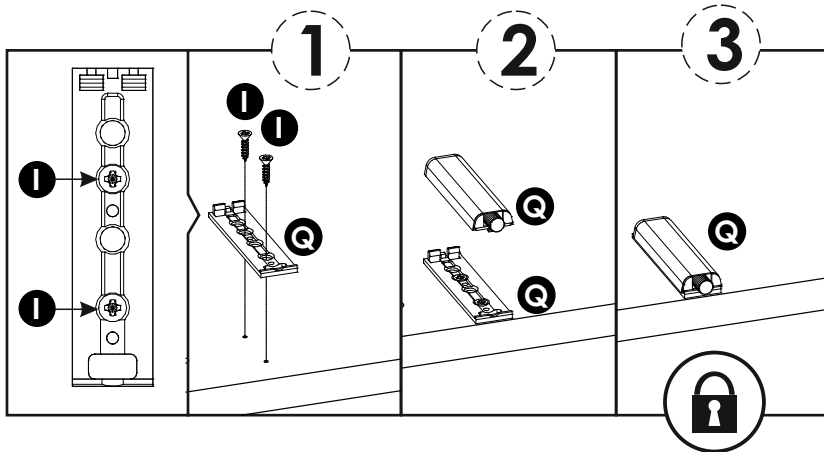
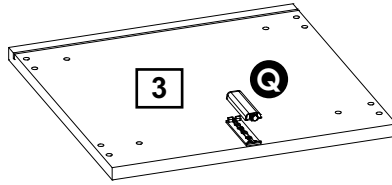
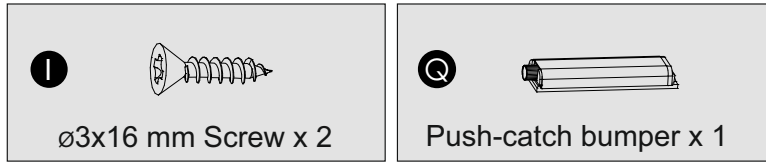

14

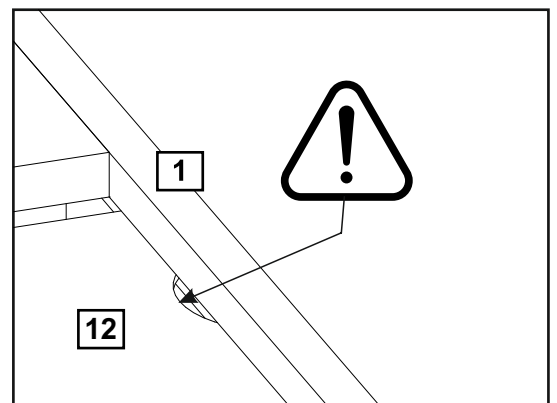
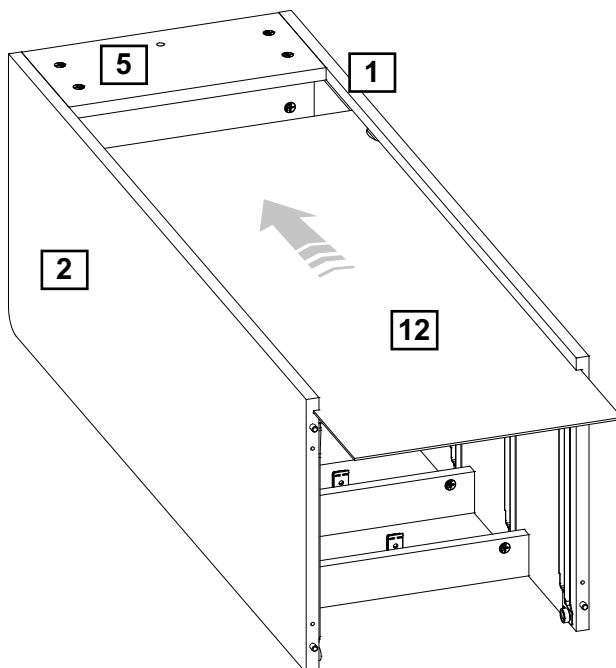

15

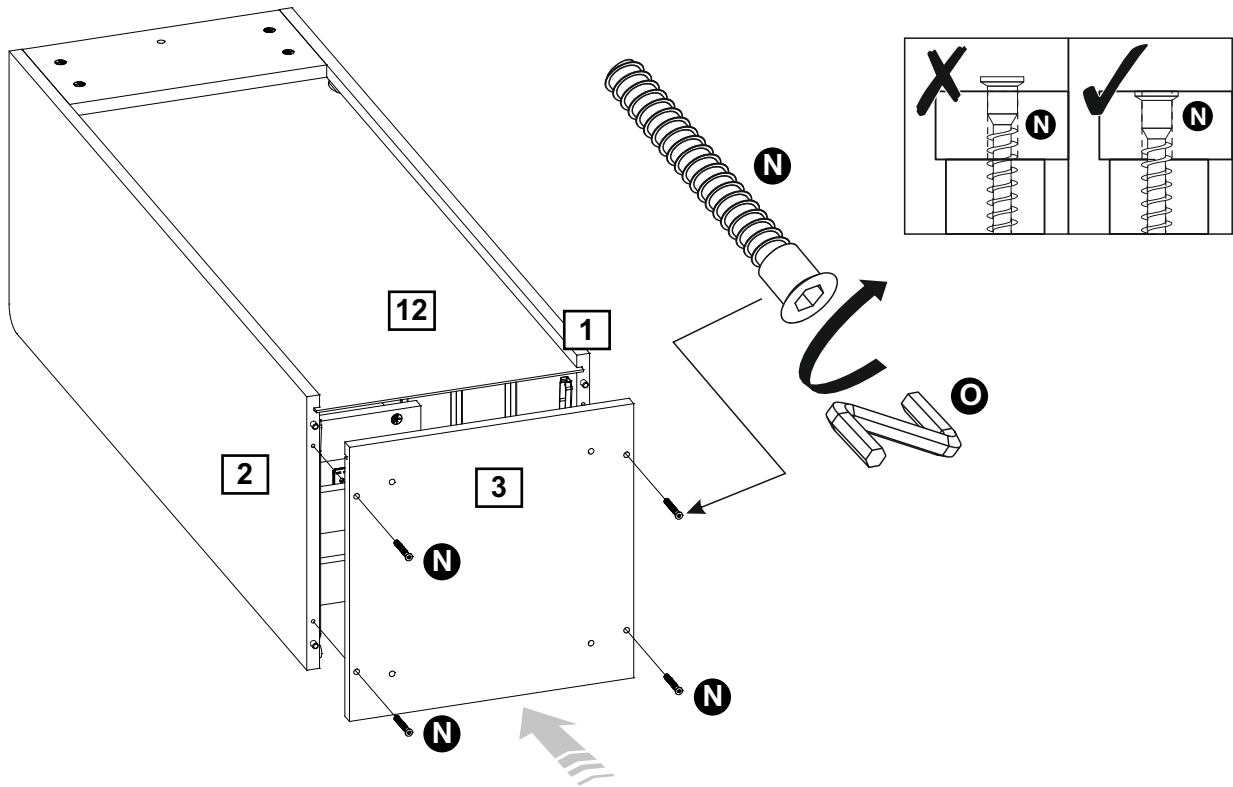
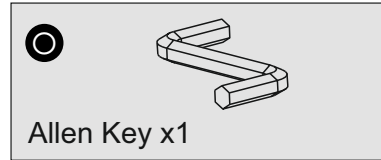
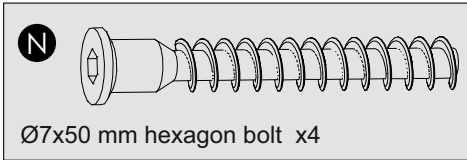

16

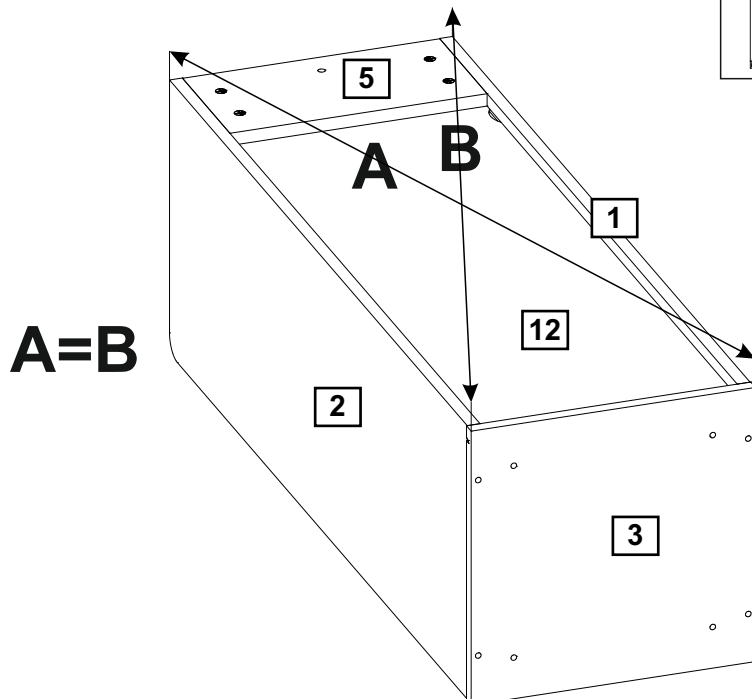
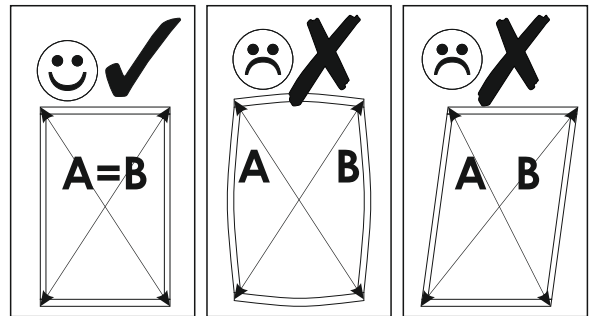

17

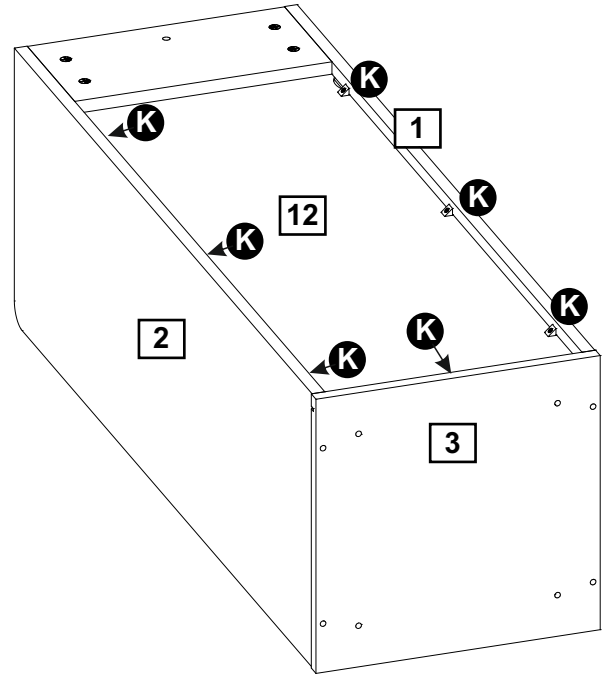
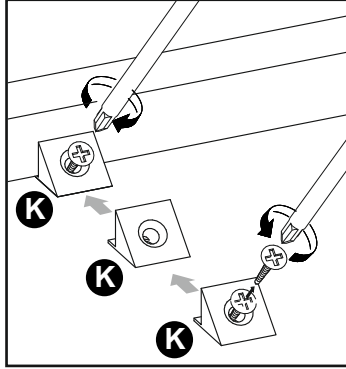
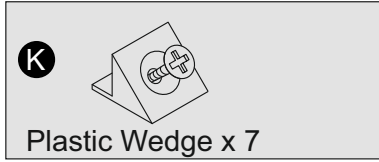

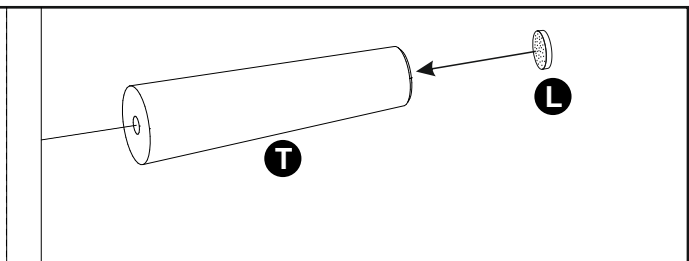
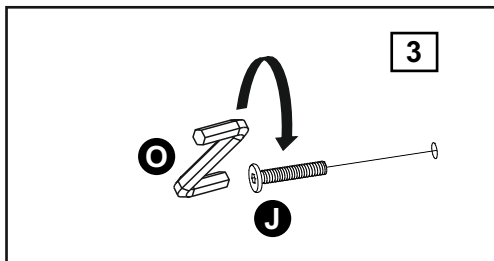
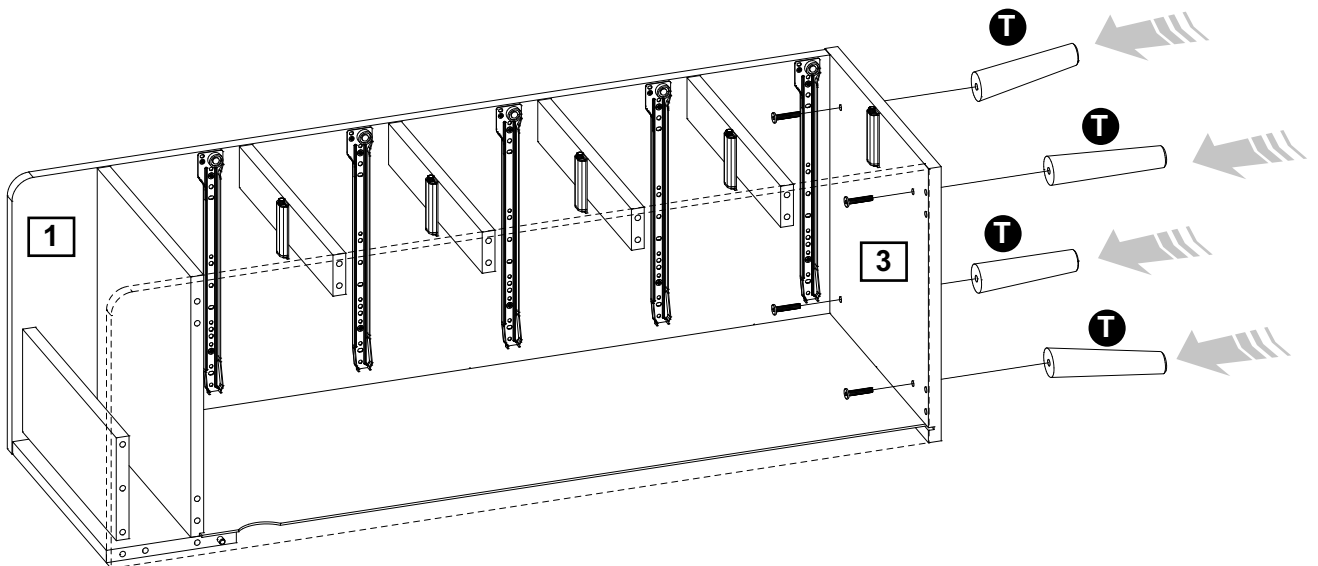
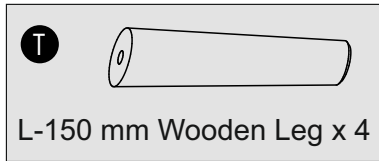
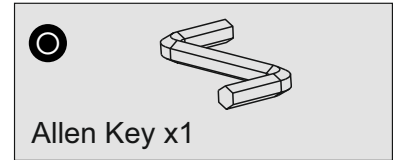
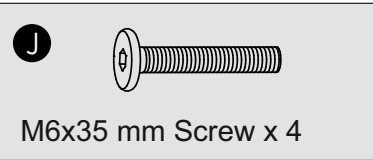

18



19

G 
Ø4x16 mm screw x 2

M 
Wall bracket x 2

U 
Height adjuster wedges set x 1

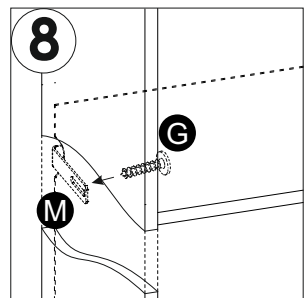
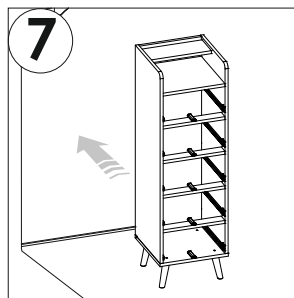
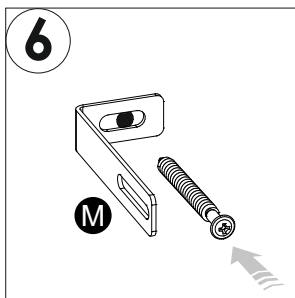
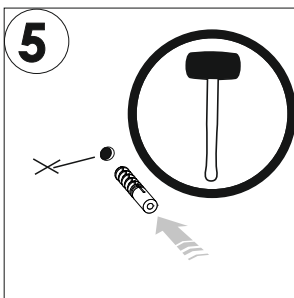
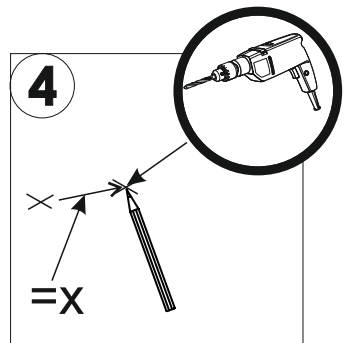
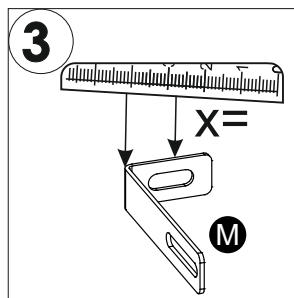
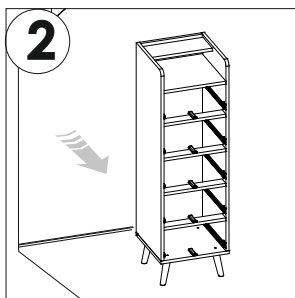
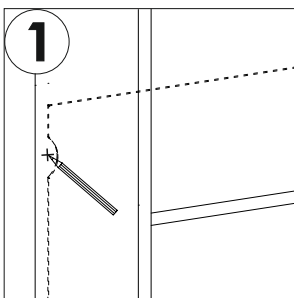
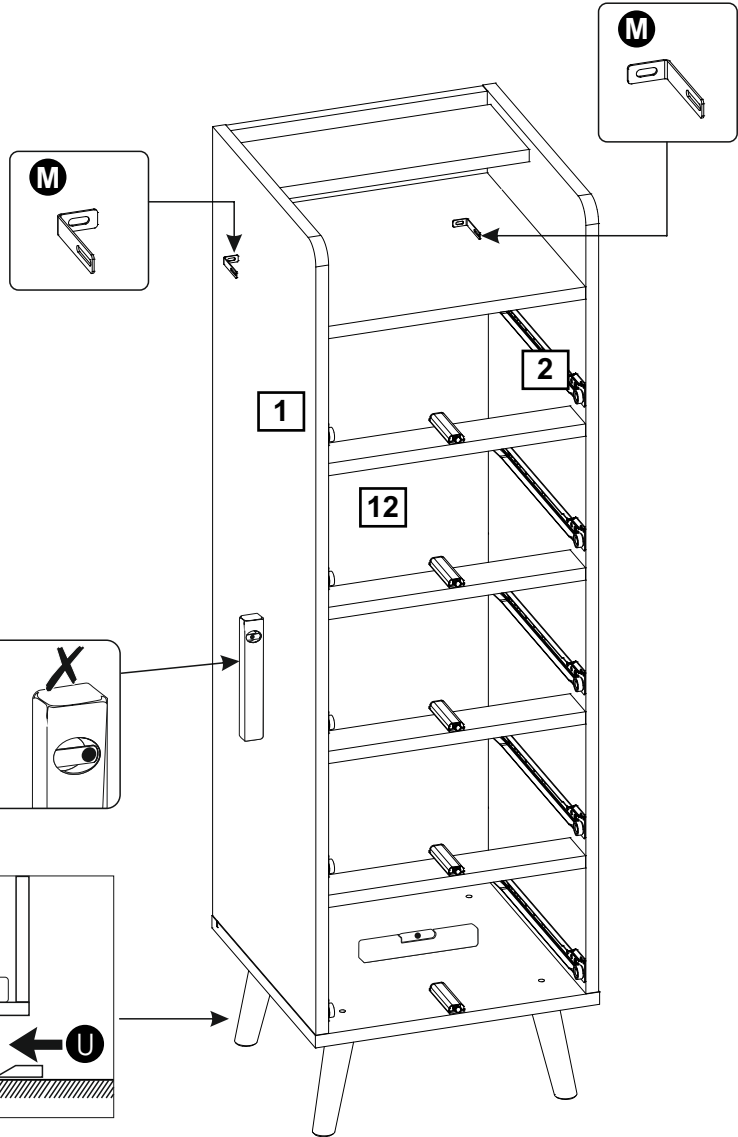
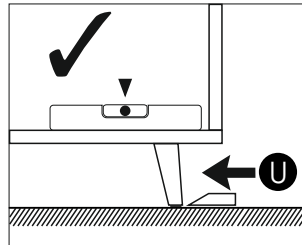
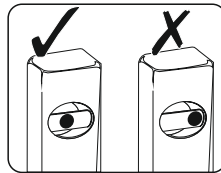
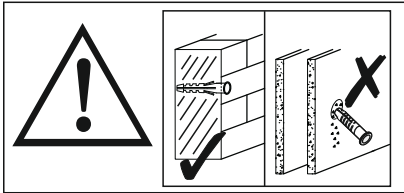
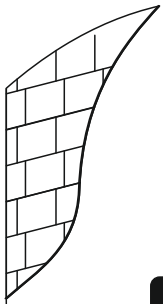

20

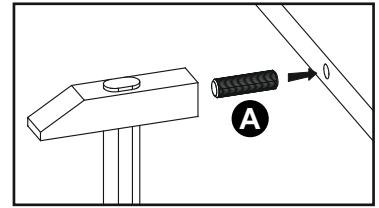
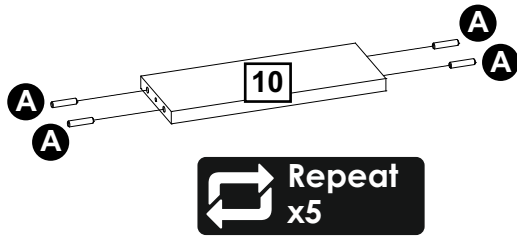
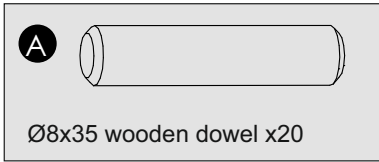

21

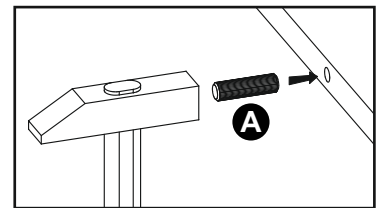
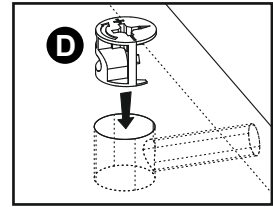
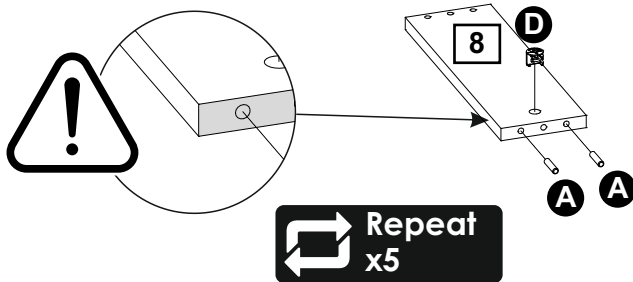
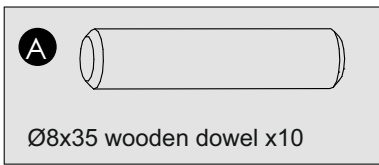

22

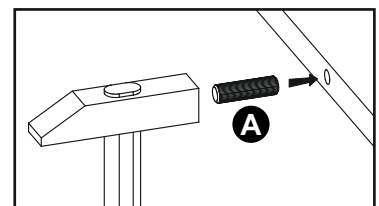
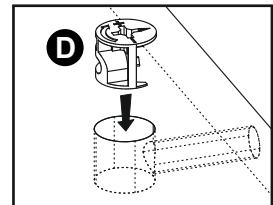
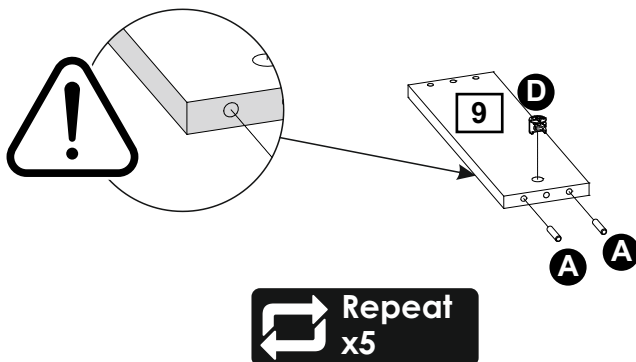
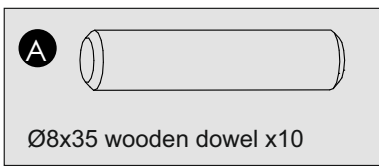

23

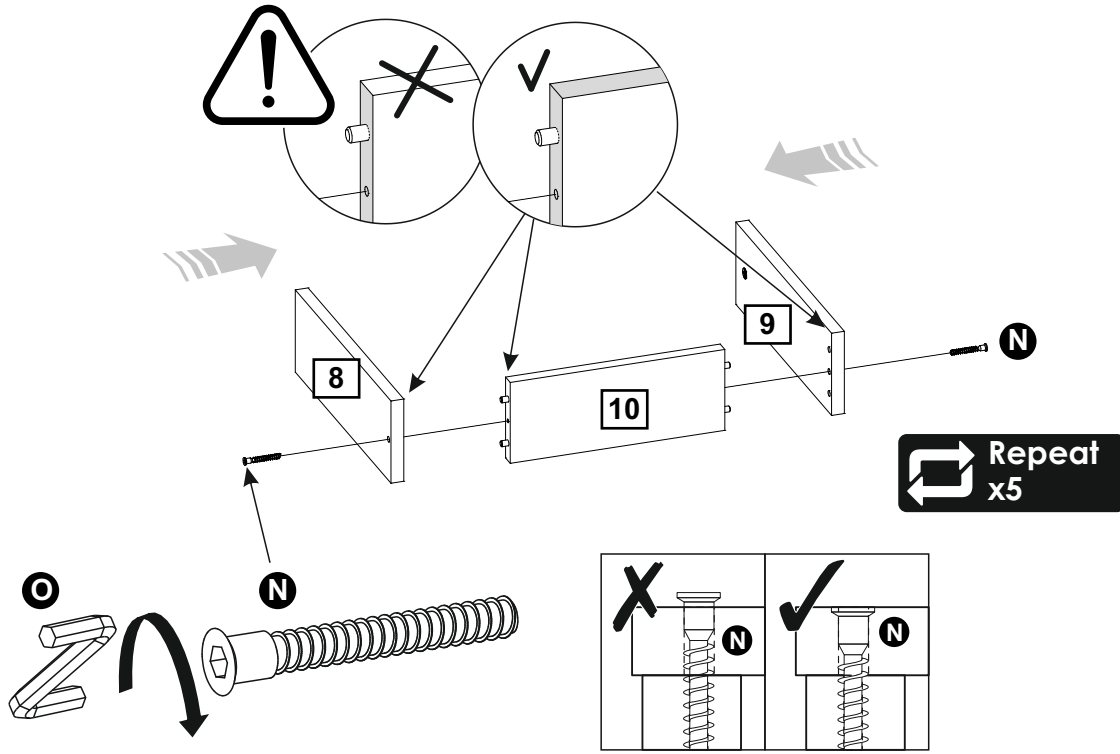
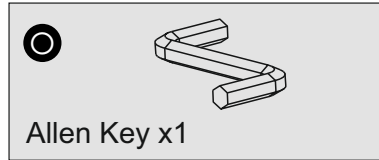
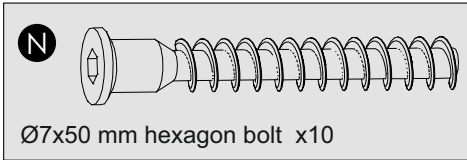

24

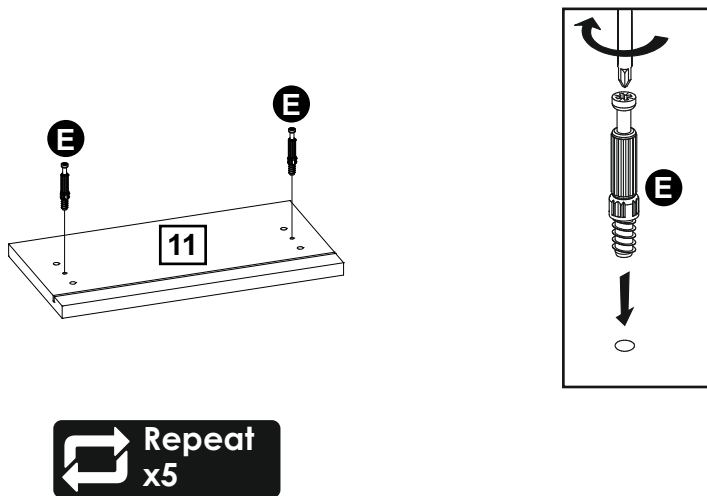
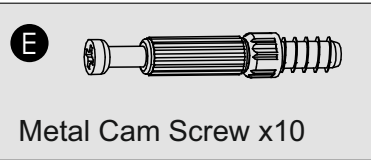

Repeat x5

25

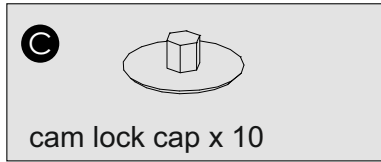

 Repeat
x5

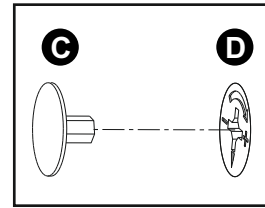
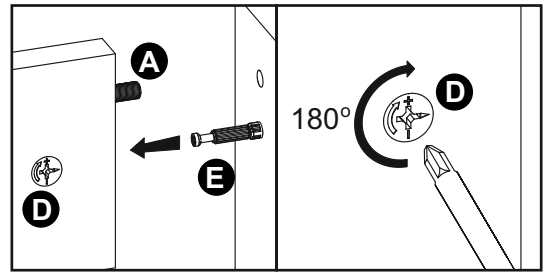
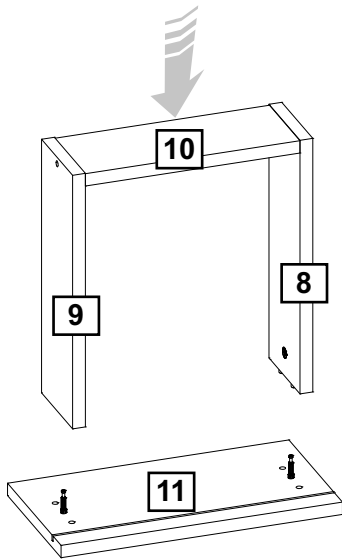

26

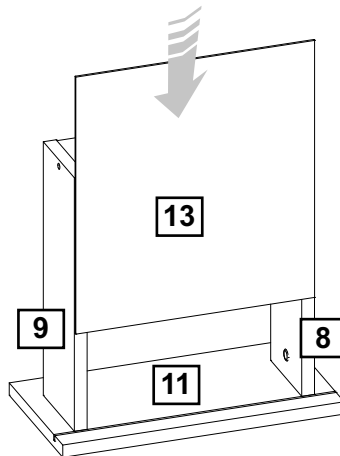

 Repeat
x5

27

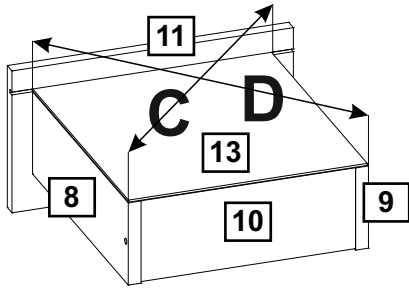

C=D

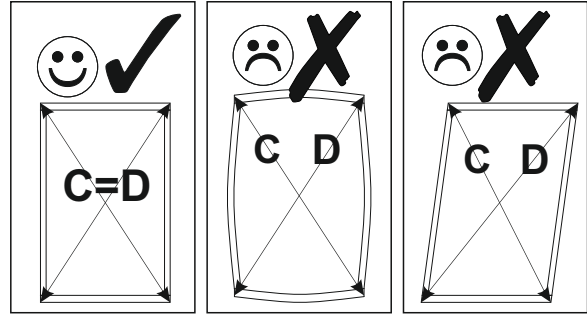

 Repeat
x5

28

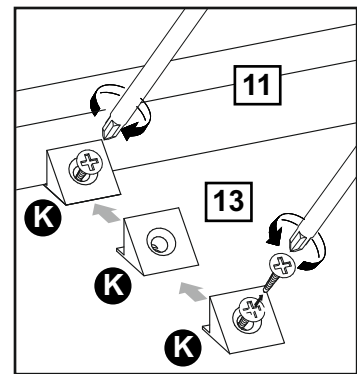
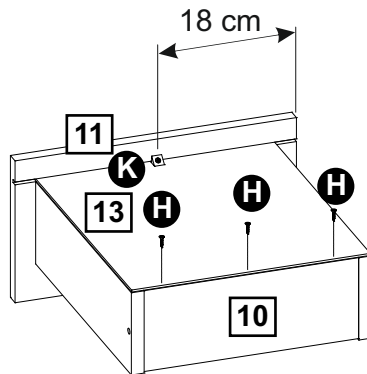
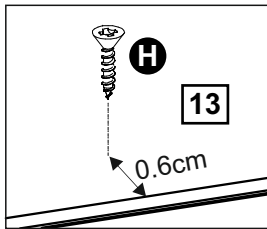
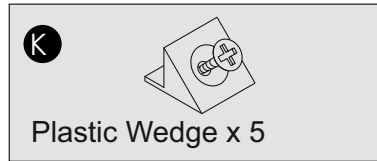
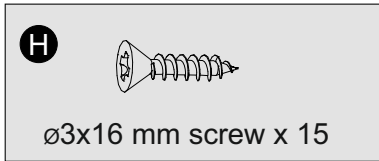

 Repeat
x5

29

B



ø3x20 mm Screw x30

S

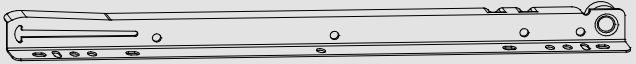

L

Drawer guide (drawer side) x 5

S

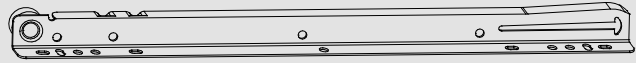

R

Drawer guide (drawer side) x 5

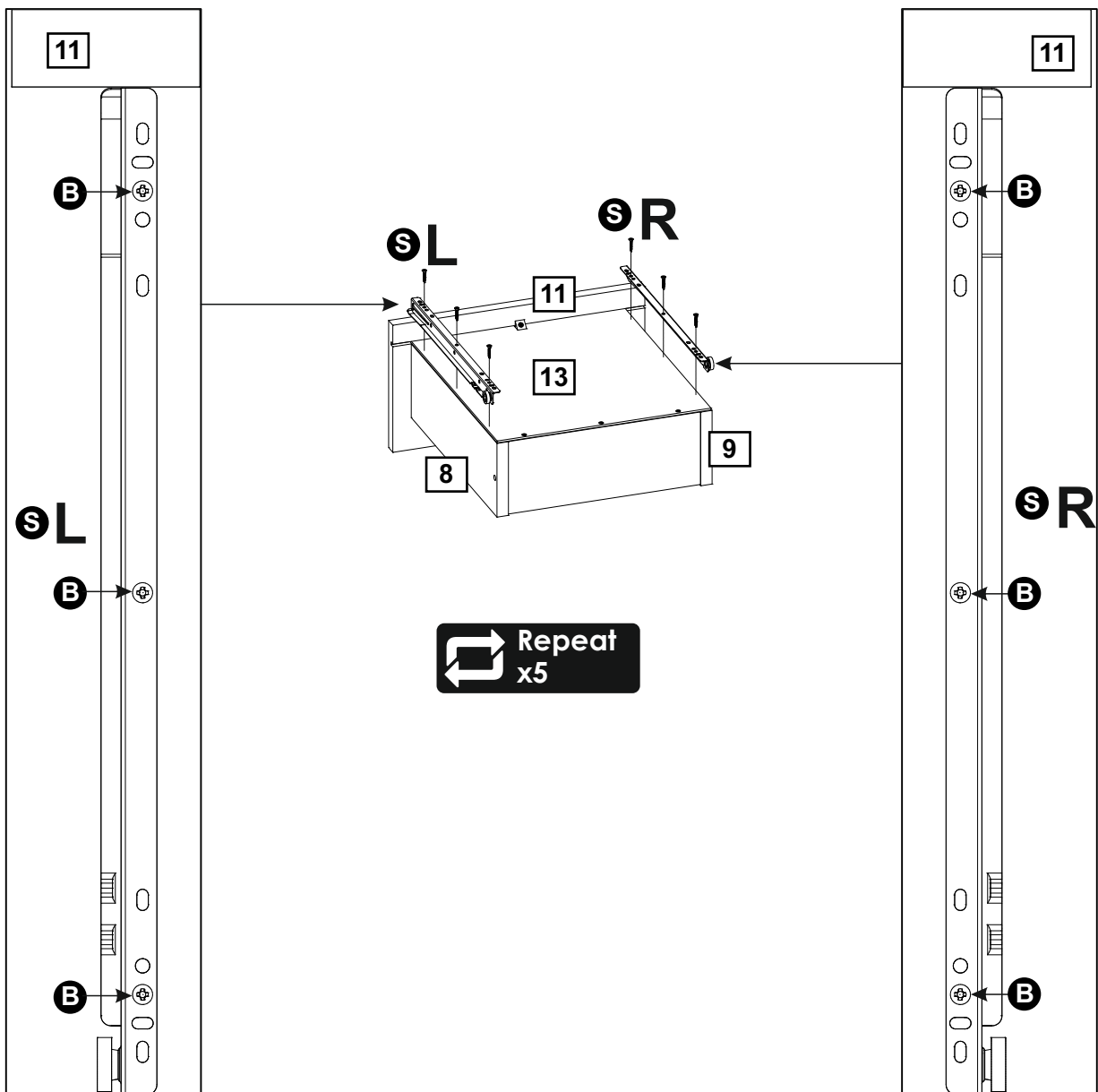

30

