



**MARVEL**

76254





[LEGO.com/sustainable-packaging](https://LEGO.com/sustainable-packaging)



# BUILDER



Apple and the Apple logo are trademarks of Apple Inc., registered in the U.S. and other countries and regions. App Store is a service mark of Apple Inc. Google Play and the Google Play logo are trademarks of Google LLC. Tencent and the Tencent logo are trademarks of Tencent Inc.

Q [LEGO.com/devicecheck](https://www.lego.com/devicecheck)

EN Ask parents' permission before going online | DE Eltern um Erlaubnis bitten, bevor du online gehst | FR Demande l'autorisation d'un parent avant d'aller en ligne | IT Chiedi il permesso ai tuoi genitori prima di andare online | ES Pídeles permiso a tus papás antes de conectarte a Internet | PT Peça autorização aos pais antes de acederes online | JA オンラインになる前に ほかの方のきよかをもらおう | ZH 上网前应先征得父母的同意 | KO 온라인 접속 전에 보호자 동의가 필요합니다 | RU Спроси разрешения у родителей, прежде чем заходить в интернет | PL Poproś rodziców o zgodę, zanim wejdiesz do Internetu | CS Než půjdeš na internet, požádej rodiče o svolení | SK Skôr než pôjdeš na internet, vypýtaj si povolenie od rodičov | HU Kérj szülői engedélyt, mielőtt online csatlakoznál! | RO Cere permisiunea părinților înainte de a te conecta online | BG Поискайте разрешение от родител, преди да влезете онлайн | LV Pirms došanās tiešsaistē palūdz atļauju vecākiem | ET Enne Interneti kasutamist küsi vanematelt luba | LT Prieš prisijungdami prie interneto, atsilkauskite tėvų

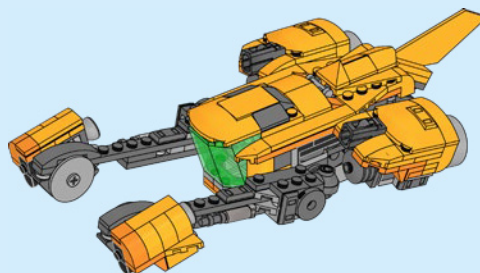
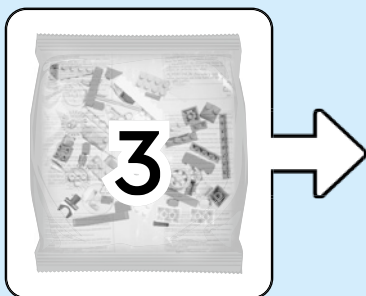
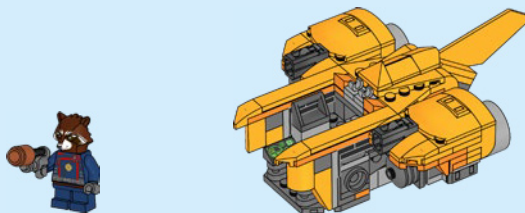
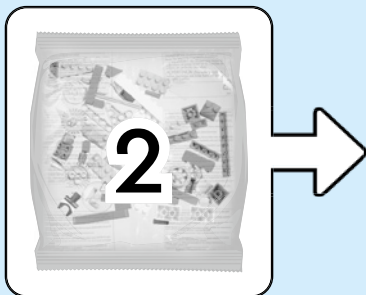
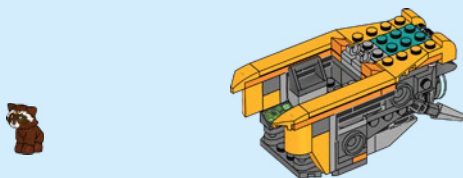
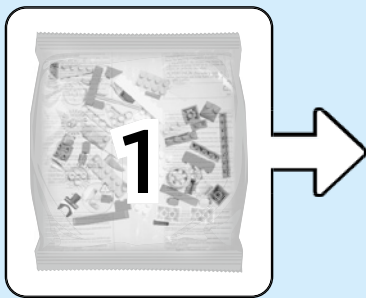



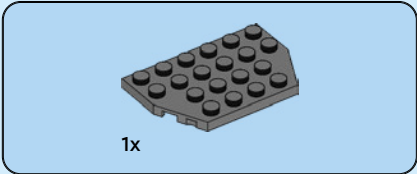
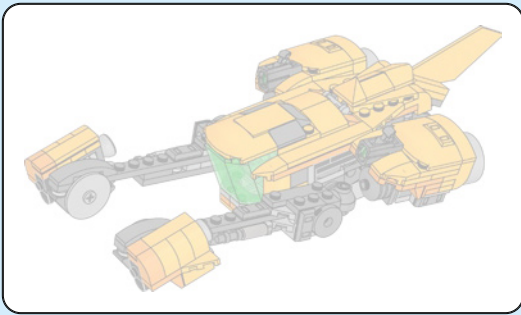

1x

1

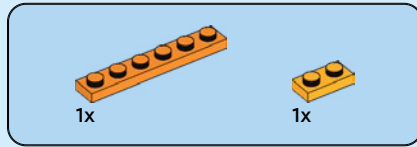
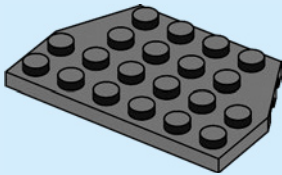

1x

1x

2

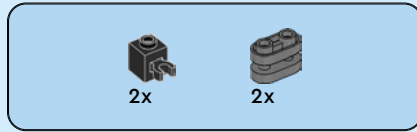
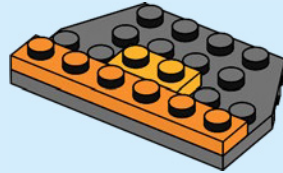

2x

2x

3

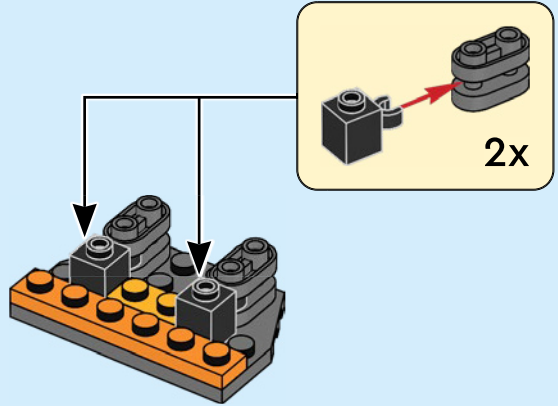

2x





2x

4

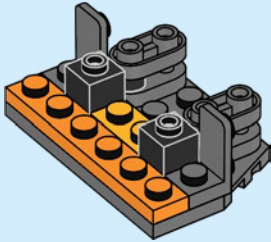

1x



2x

5

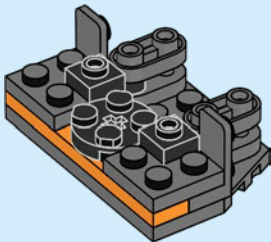

2x

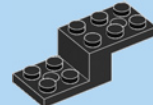

1x

6

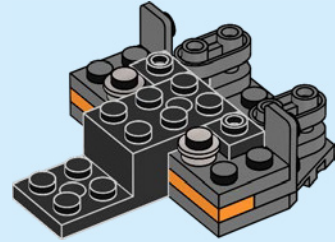

2x

7

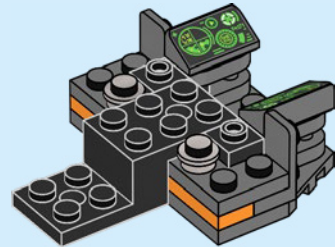



2x

8

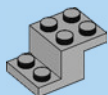
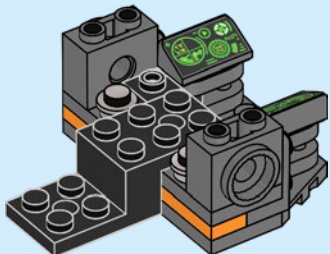

2x

9

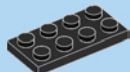
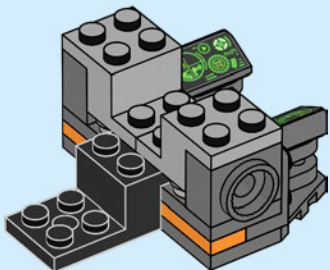

1x



1x

10

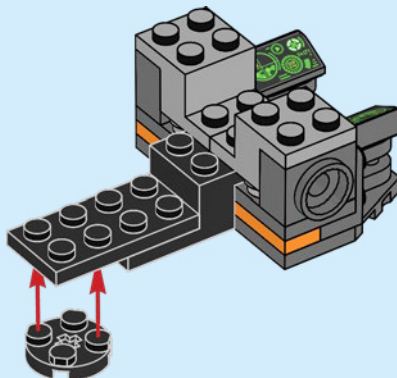

2x



1x

11

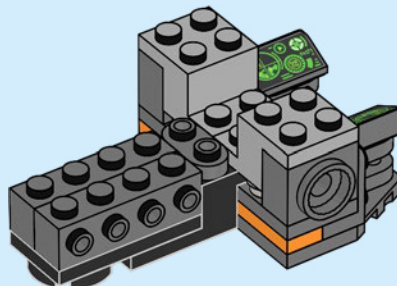



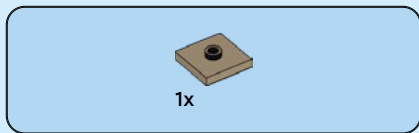

12

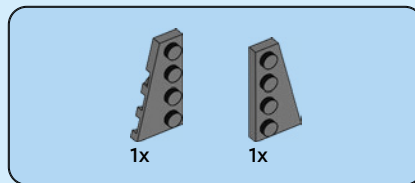
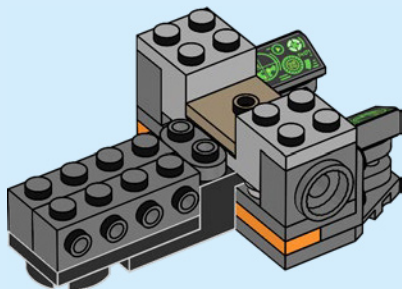

14

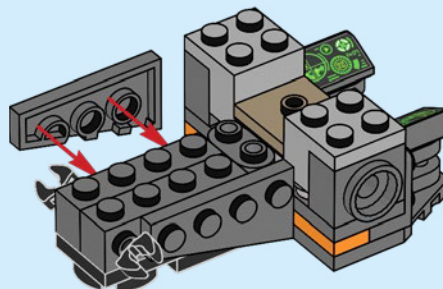

13

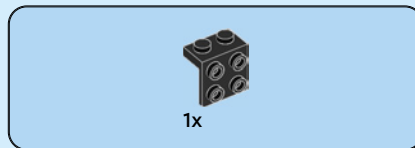
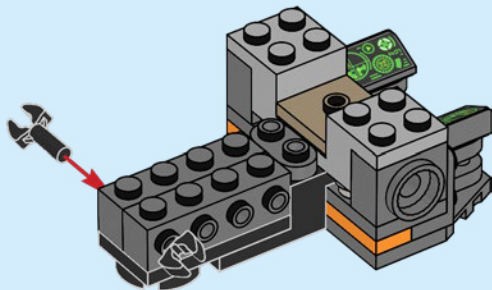

15

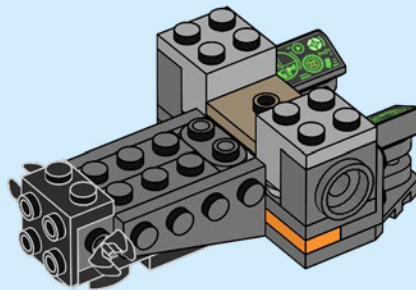

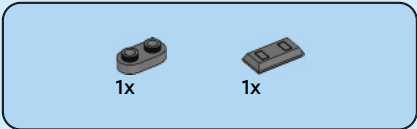

16

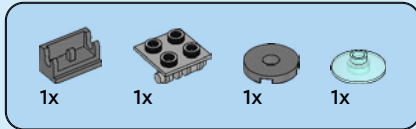
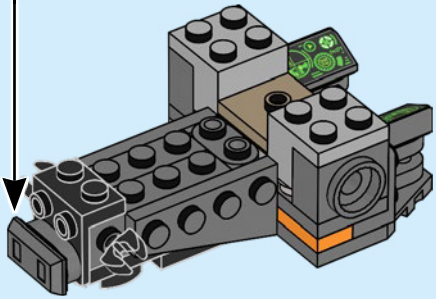
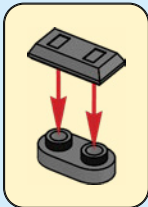

17

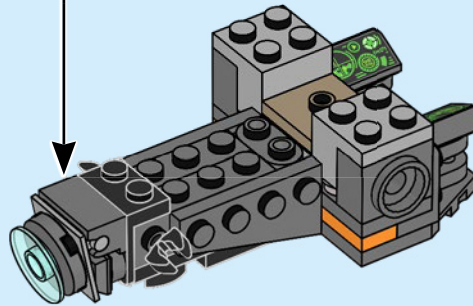
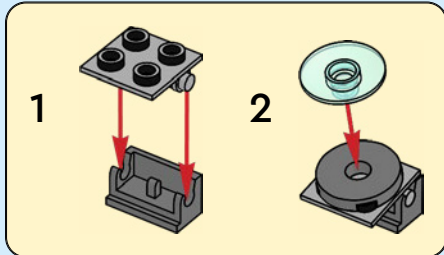

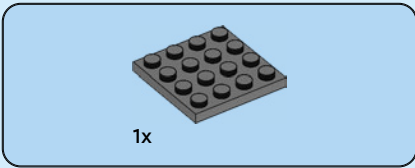

18

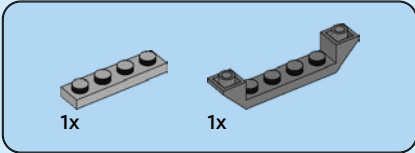
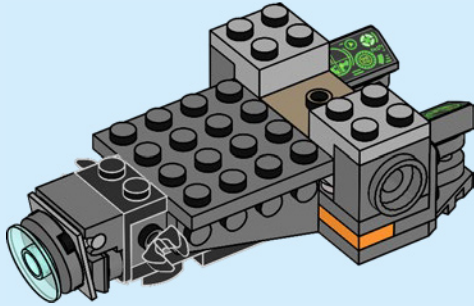

19

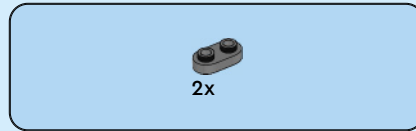
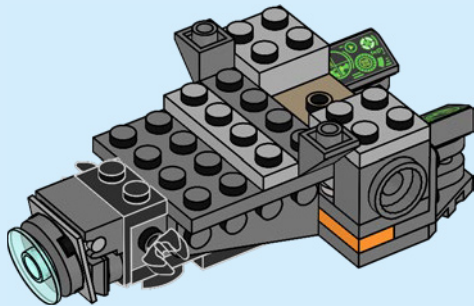

20

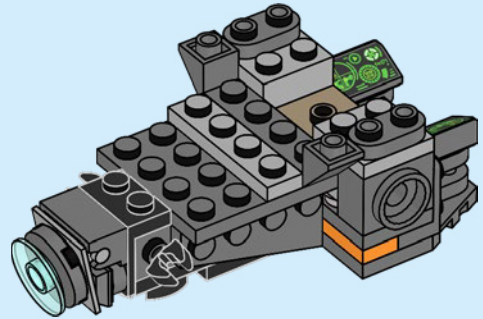



2x

21

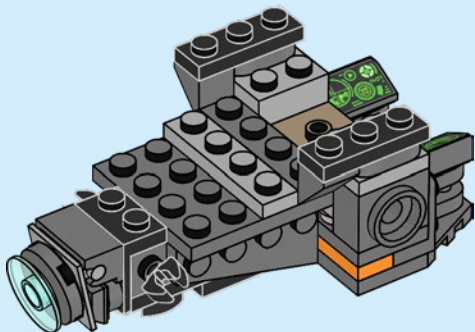

1x

22

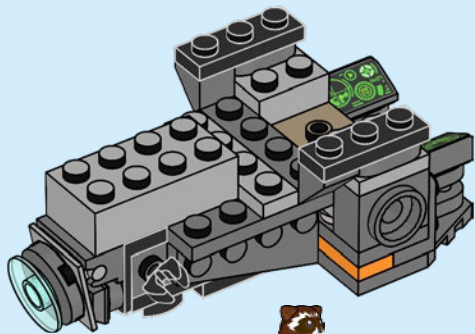

2x



2x

23

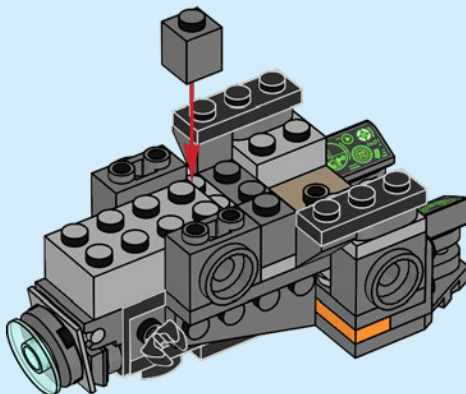



1x



2x

24

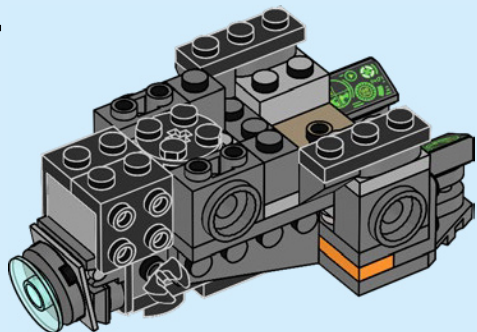

2x



2x

25

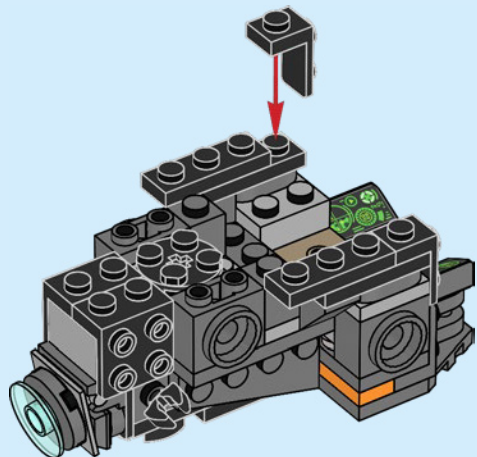

2x

26

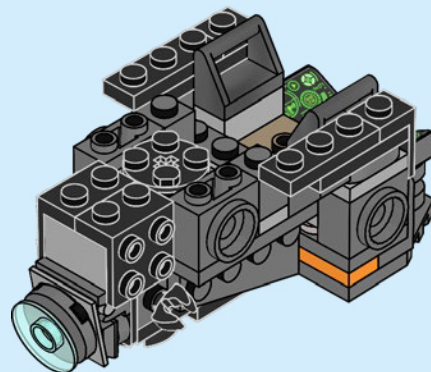



1x



1x

# 27

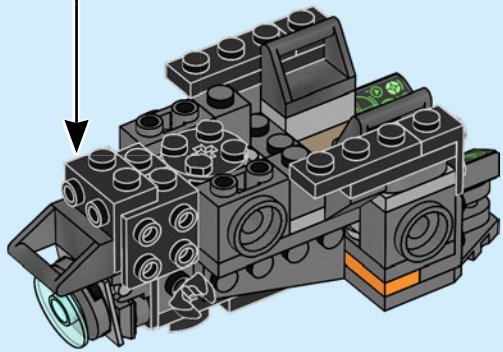
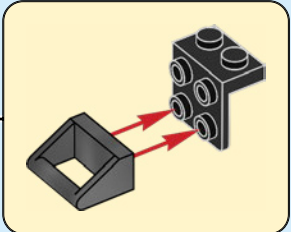

2x

# 28

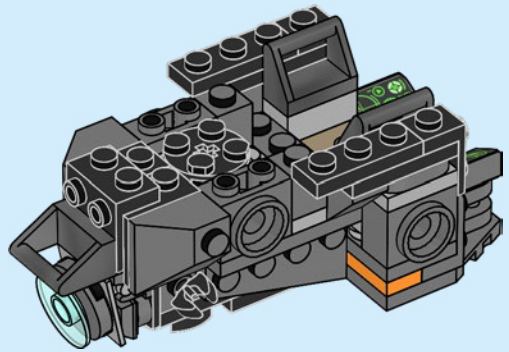

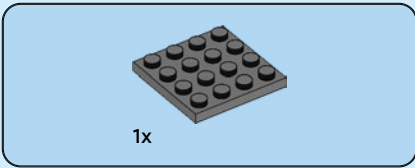

29

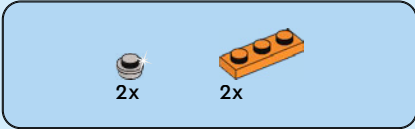
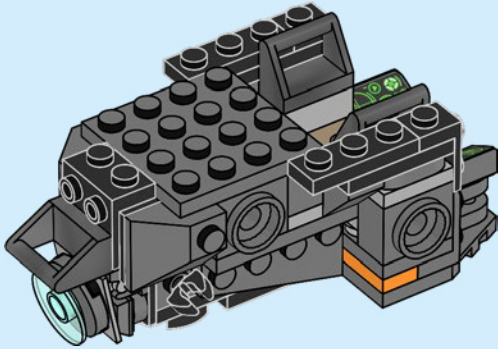

30

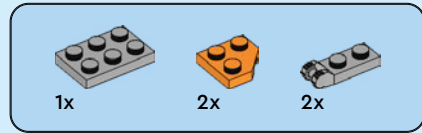
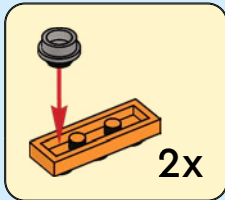
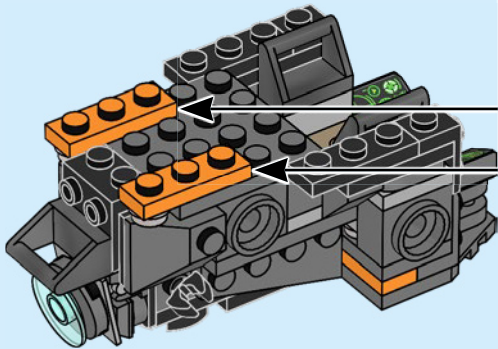

31

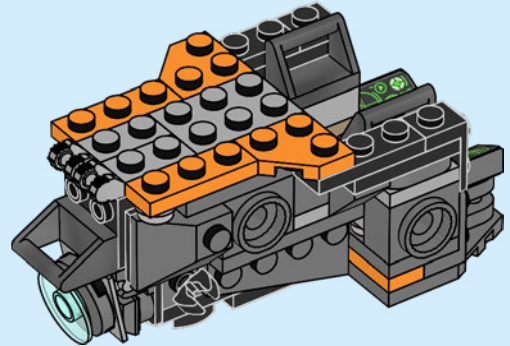

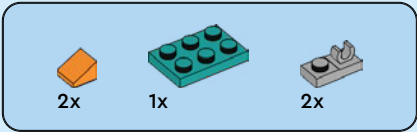

32

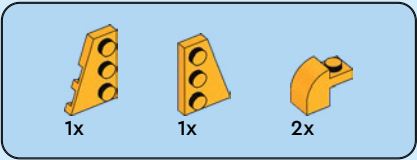
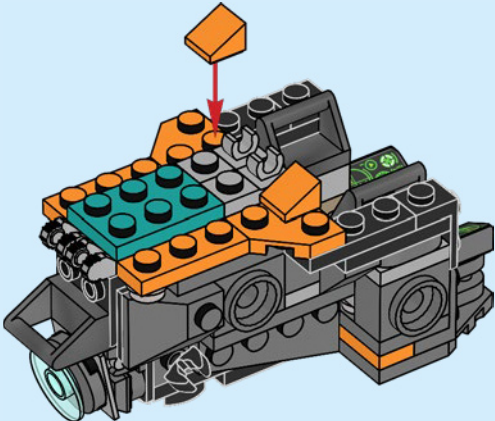

33

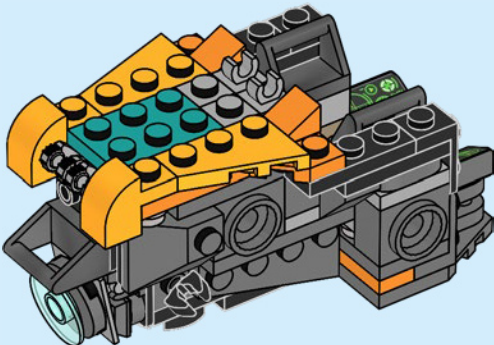



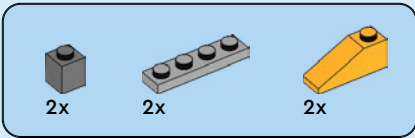

34

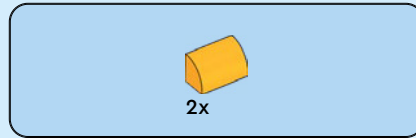
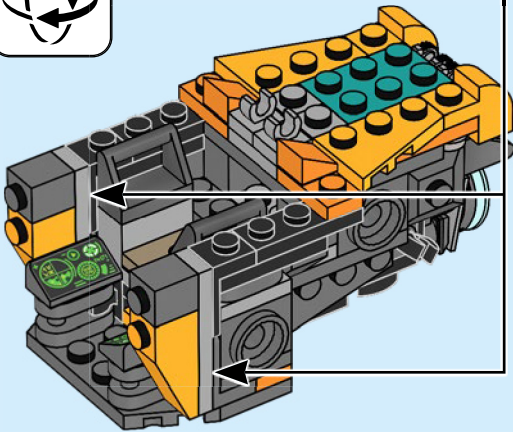
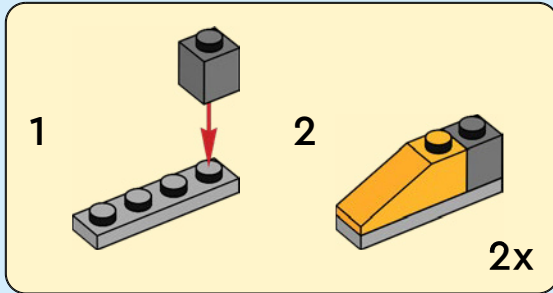

35

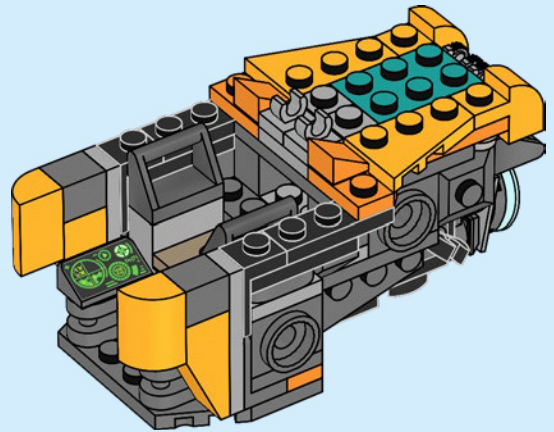

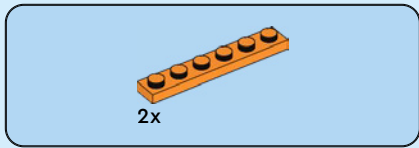

36

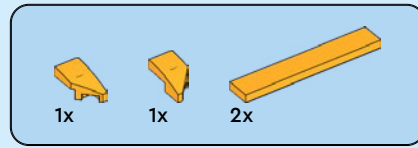
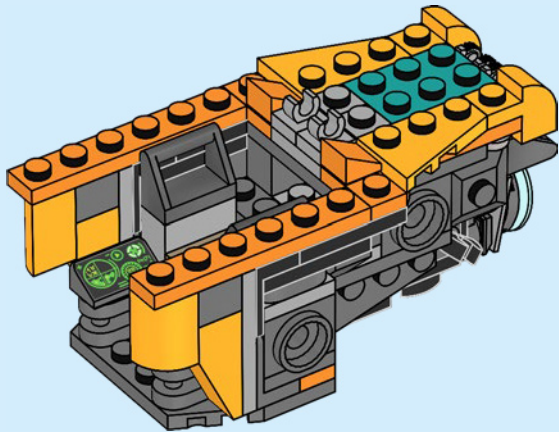

37

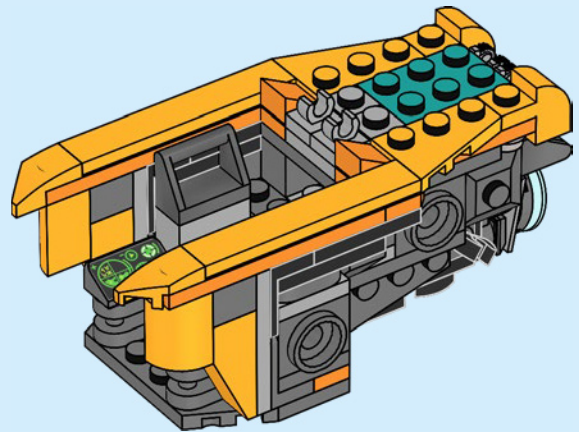

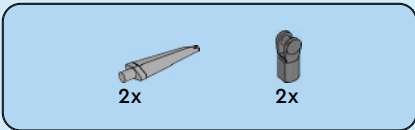

38

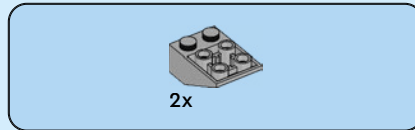
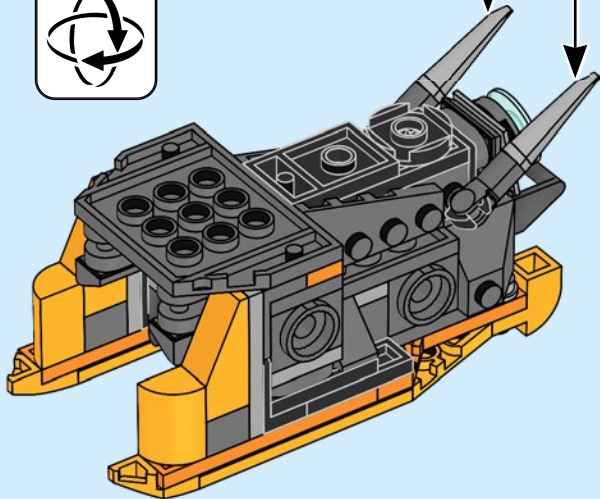
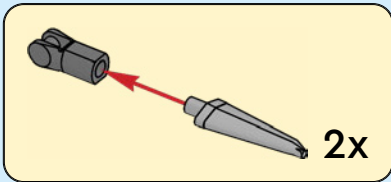

39

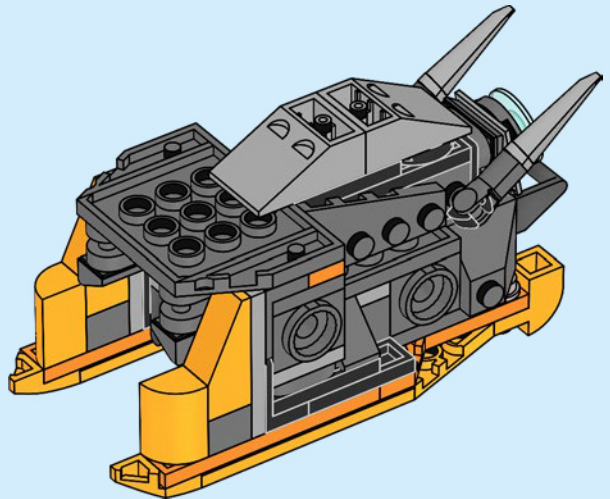

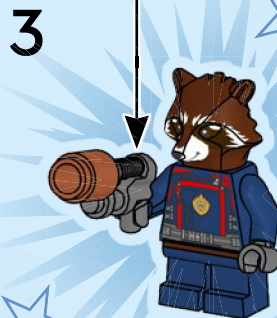
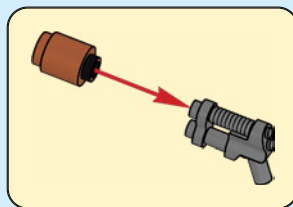
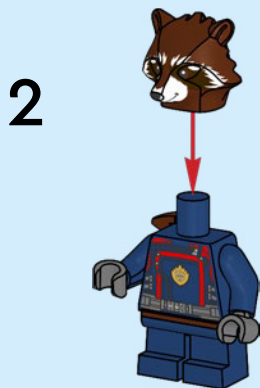
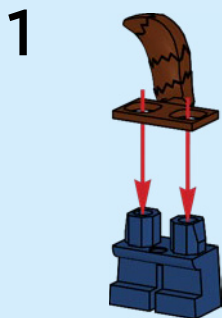

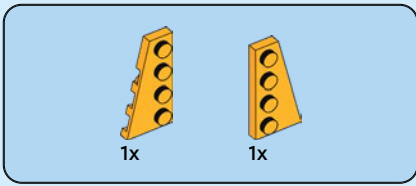

40

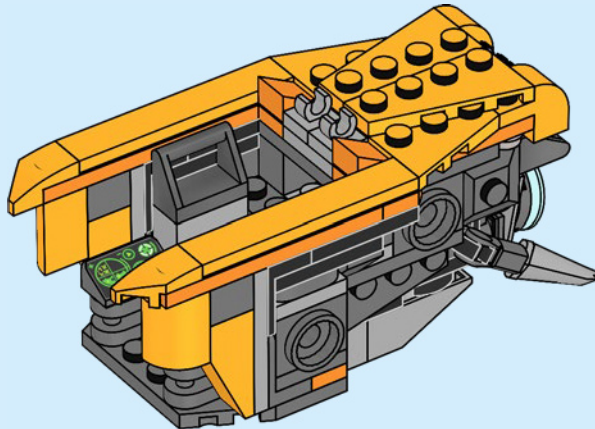

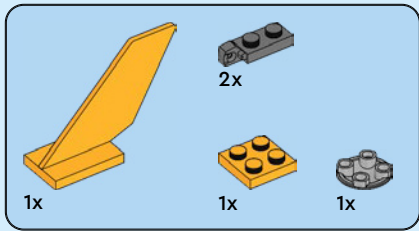

41

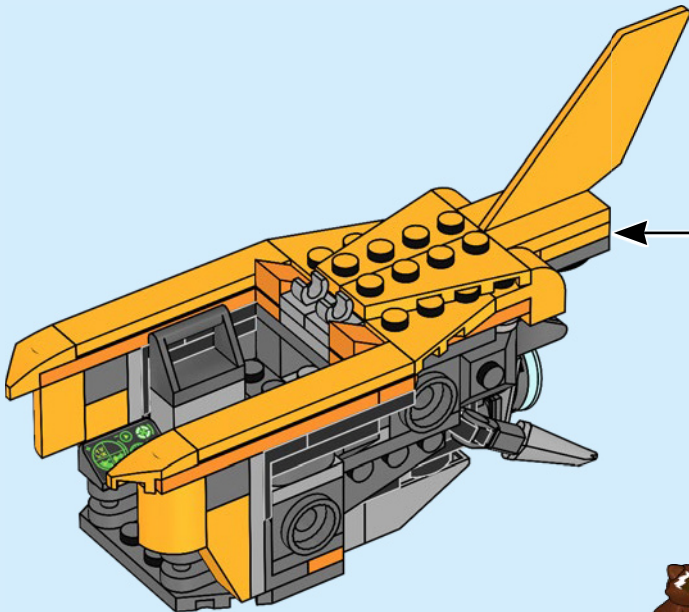
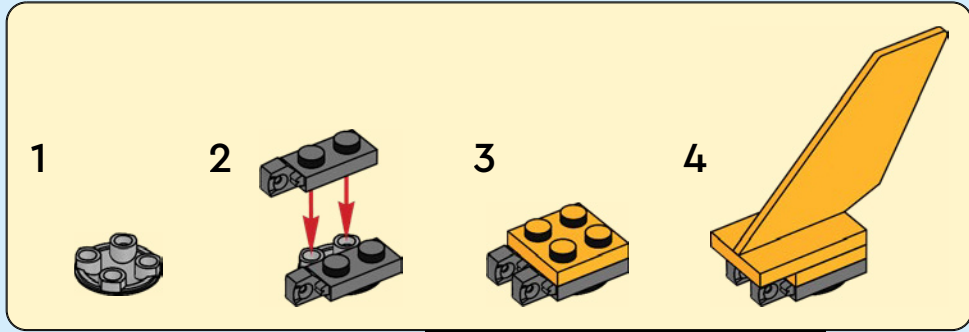

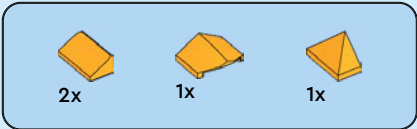

42

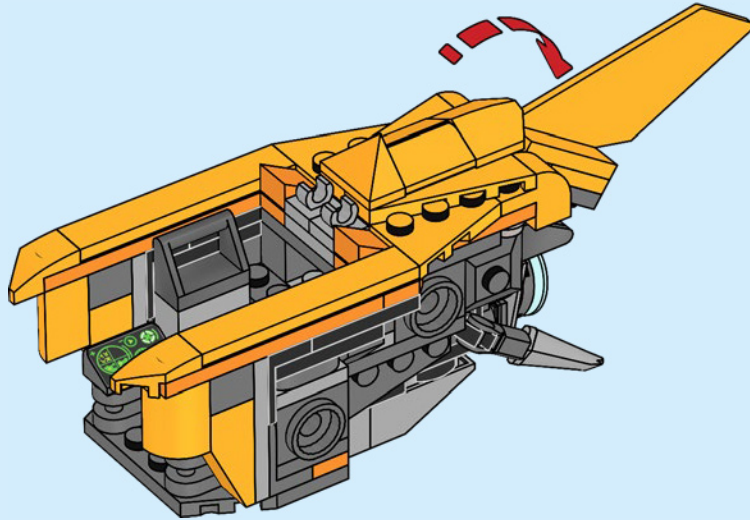

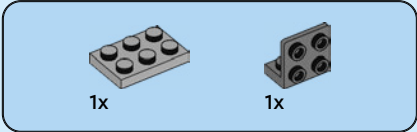
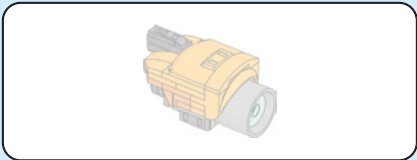

43

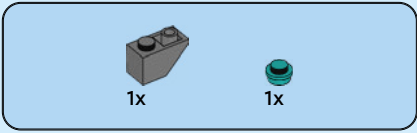
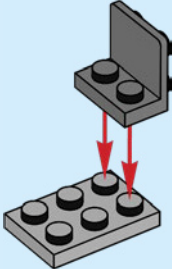

44

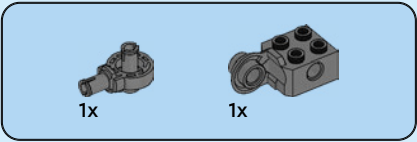
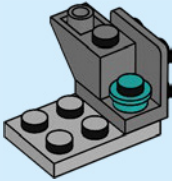

45

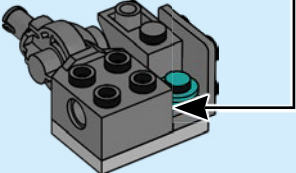
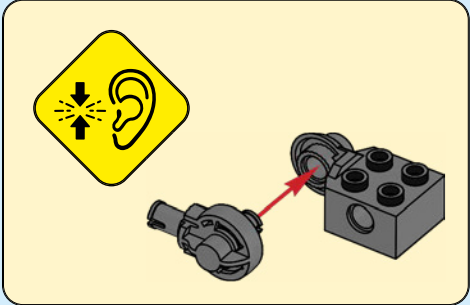





2x

46

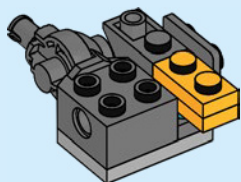
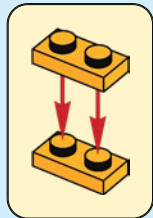

1x



1x

47

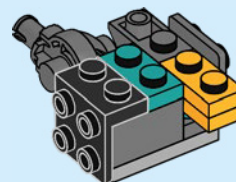

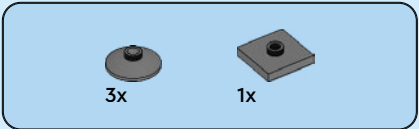

48

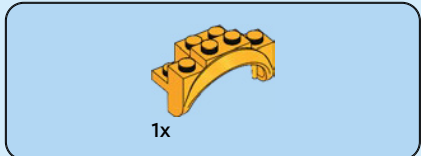
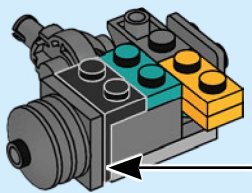
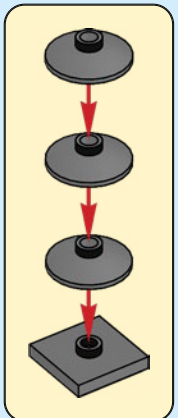

49

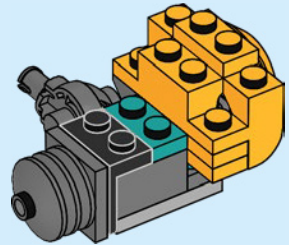

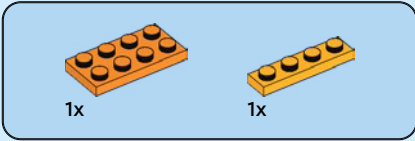
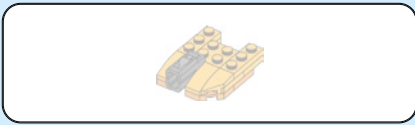

50

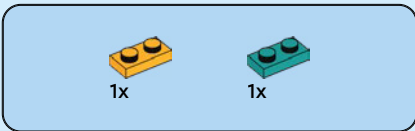
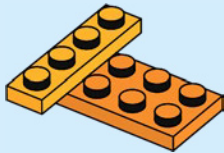

51

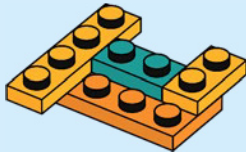

52

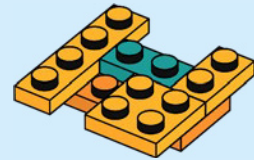

53

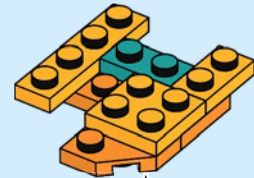

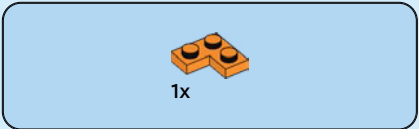

54

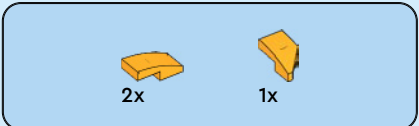
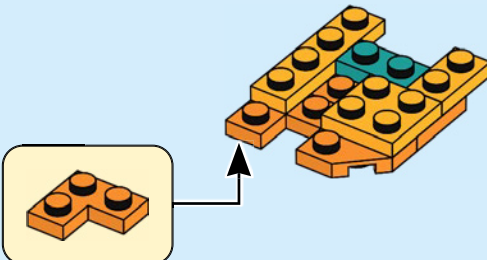

55

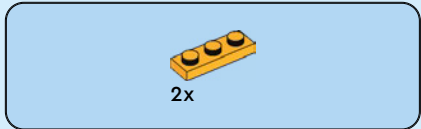
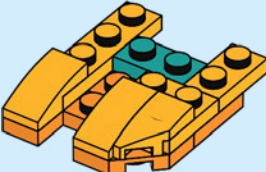

56

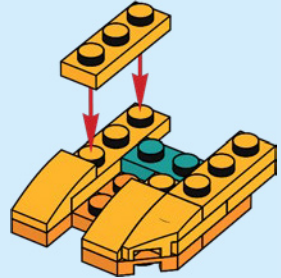

57

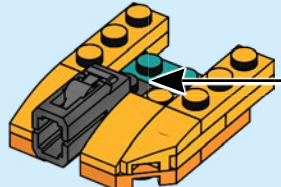
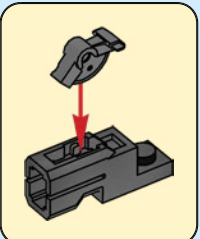



58

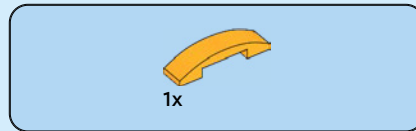
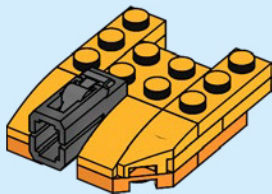

60

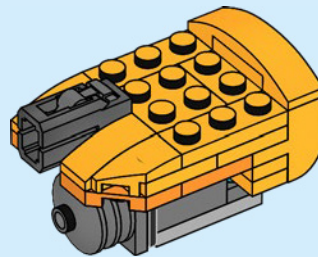

59

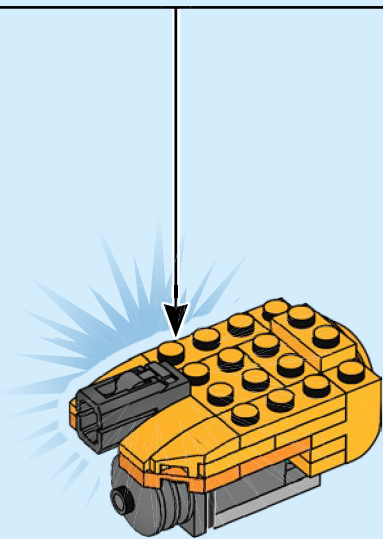

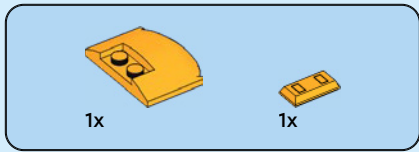

61

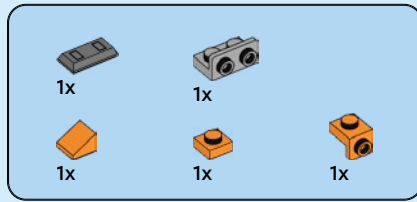
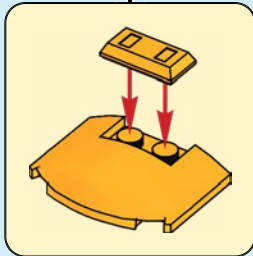
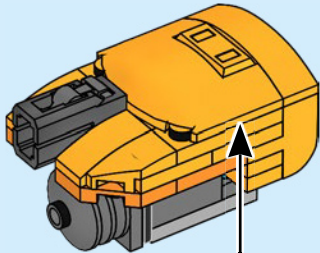

62

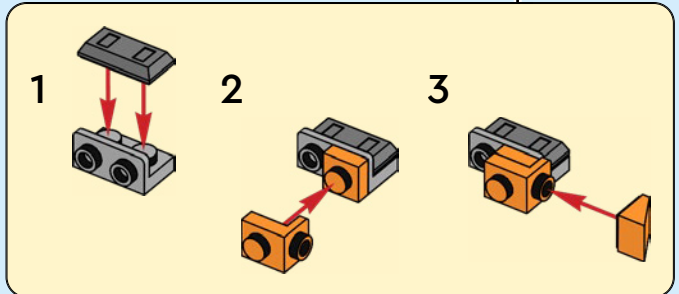
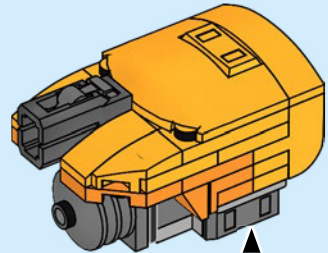

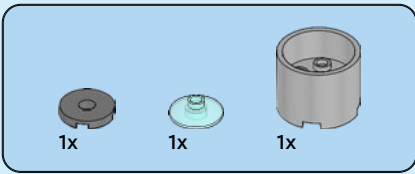

63

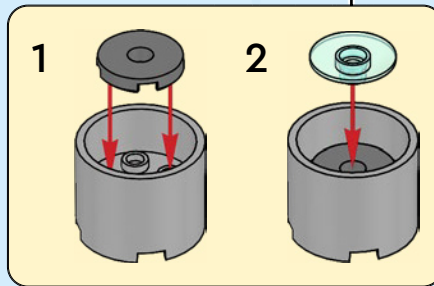
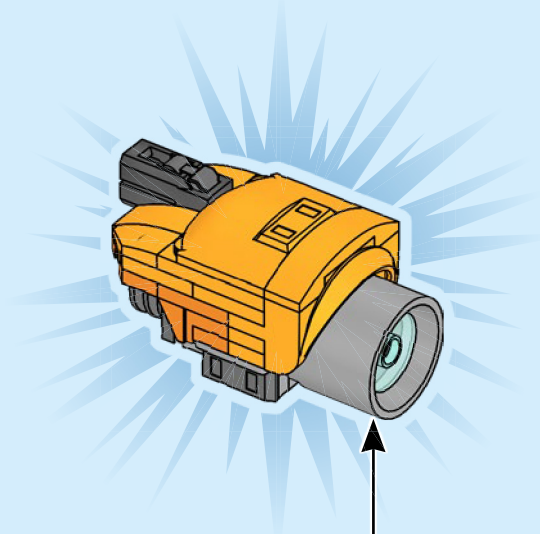

64

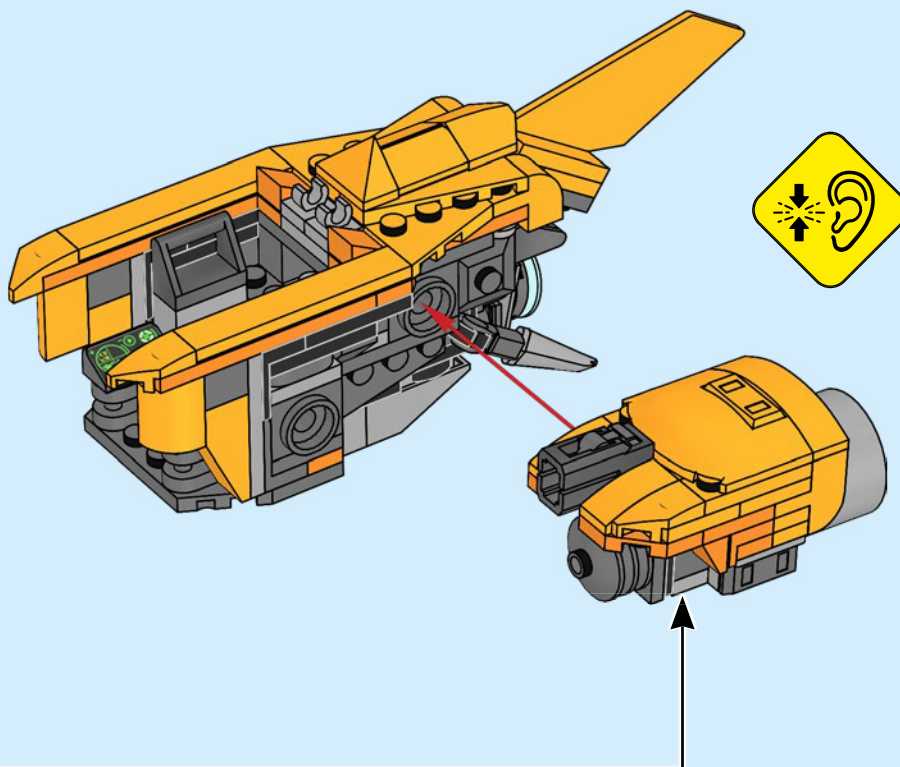



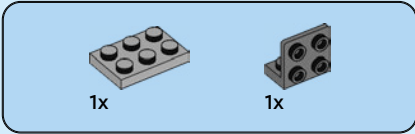
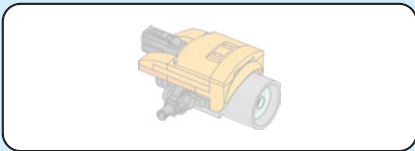

65

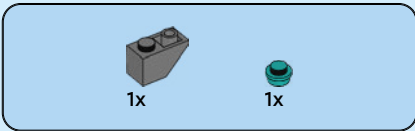
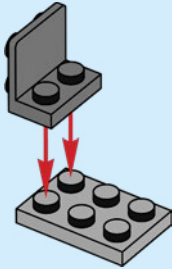

66

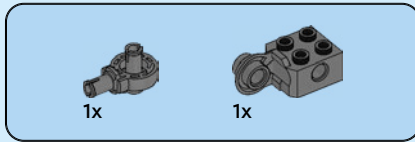
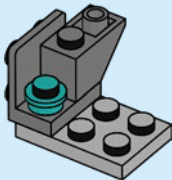

67

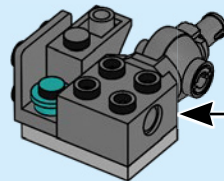
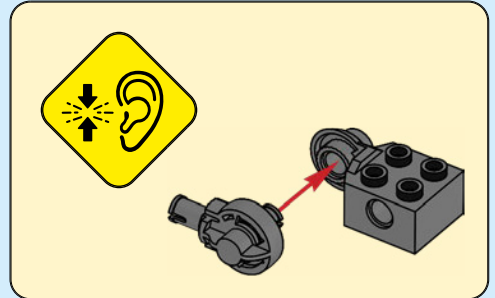



2x

68

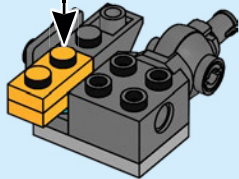
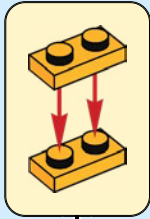

1x



1x

69

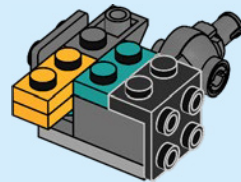

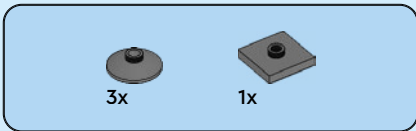

70

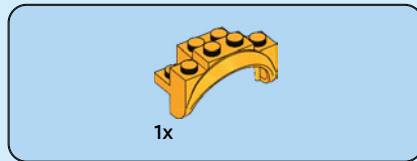
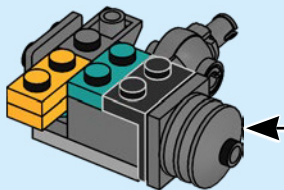
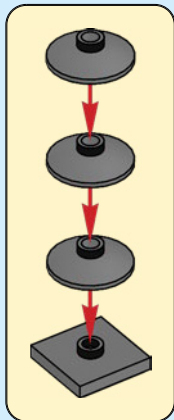

71

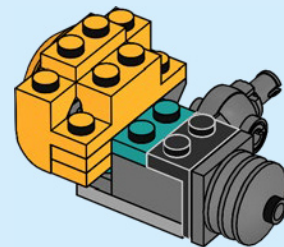

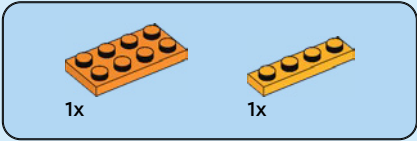
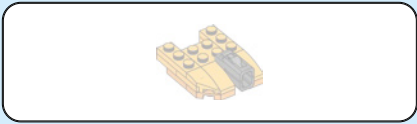

72

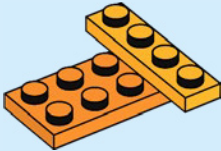

73

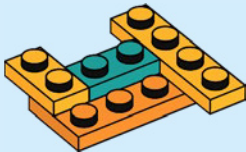

74

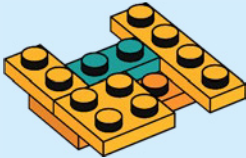

75

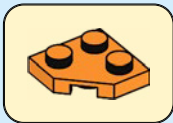
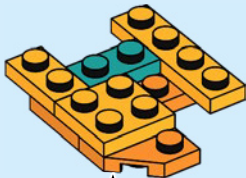

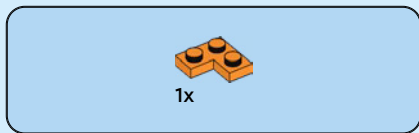

76

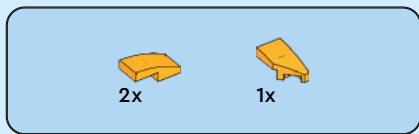
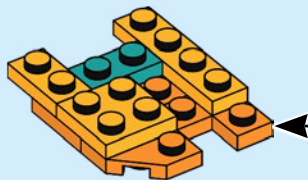
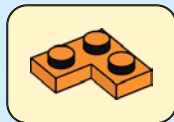

77

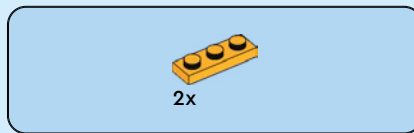
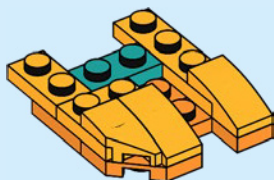

78

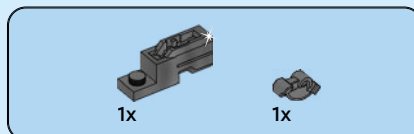
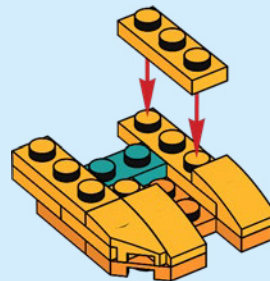

79

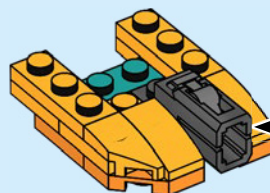
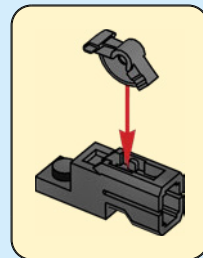



1x

80

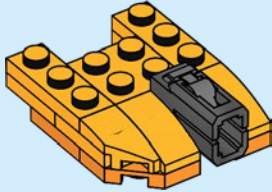

81

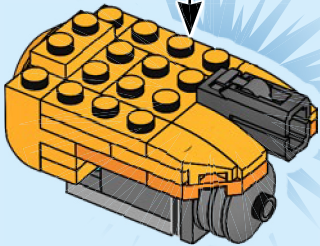

1x

82

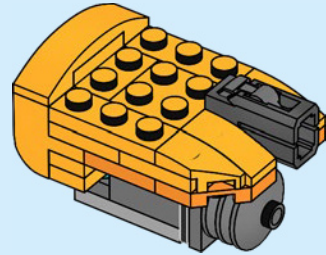

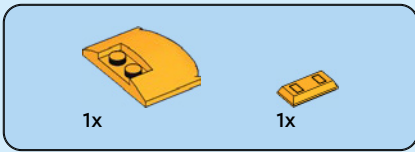

83

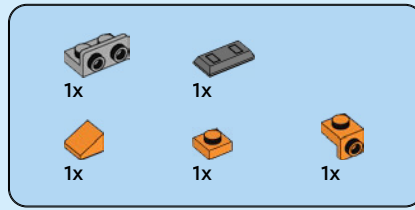
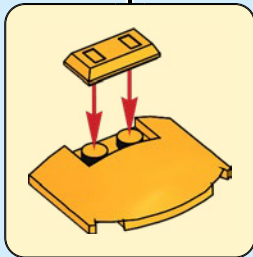
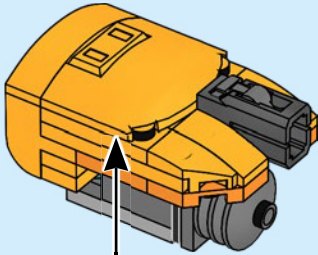

84

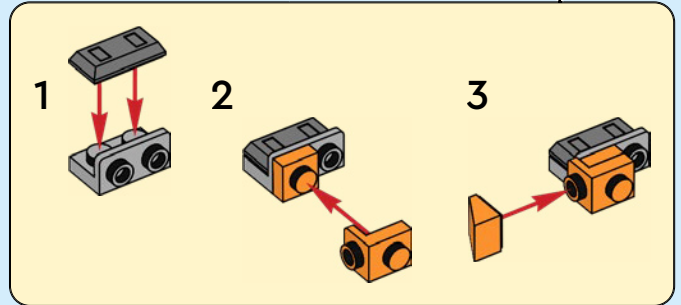
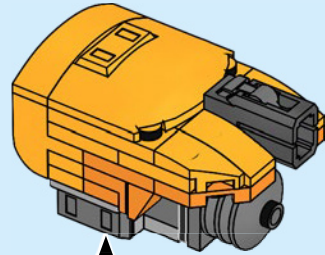

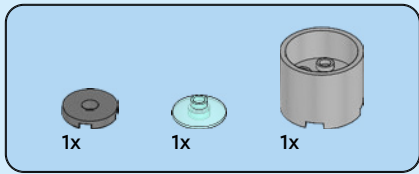

85

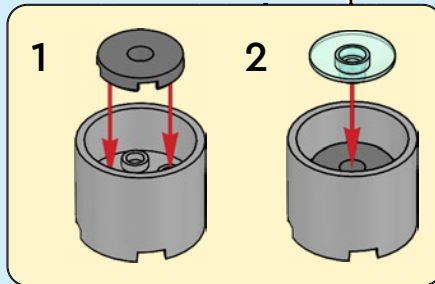
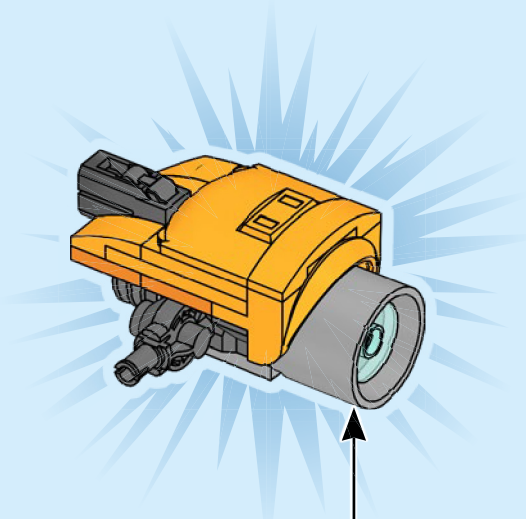



86

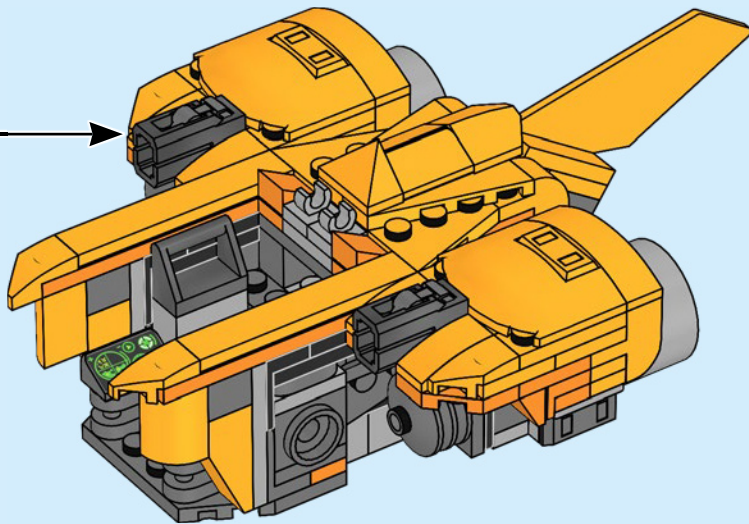

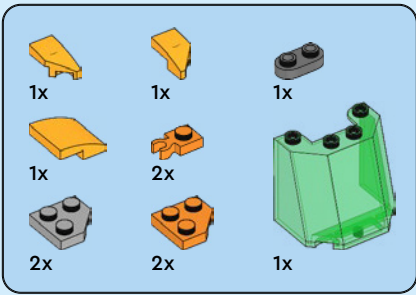

# 87

1

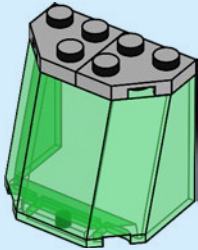

2



3



4

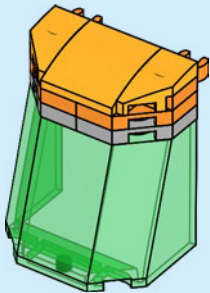

5

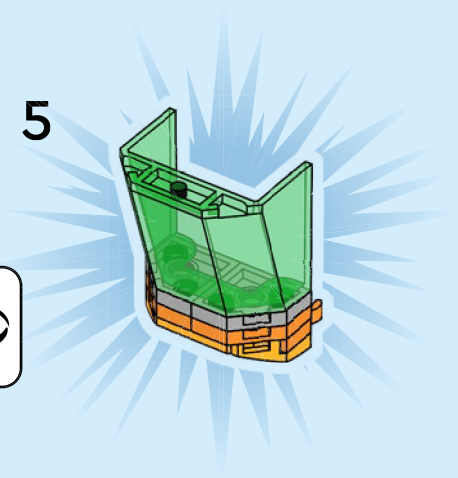
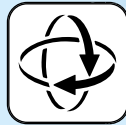

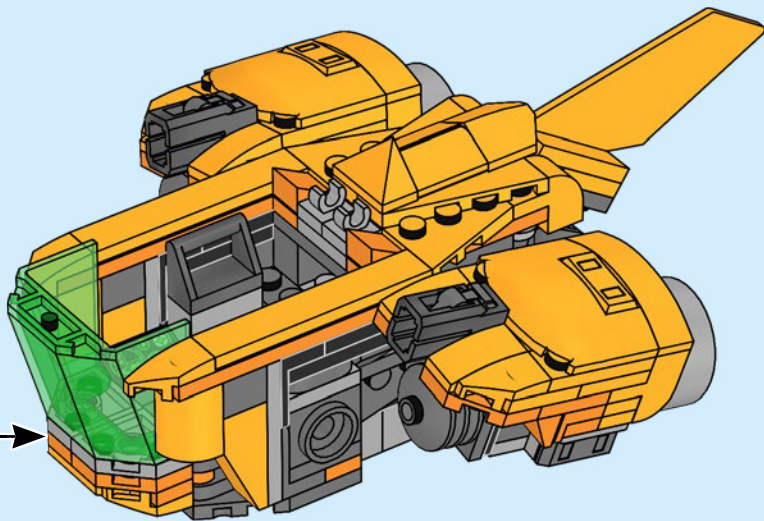

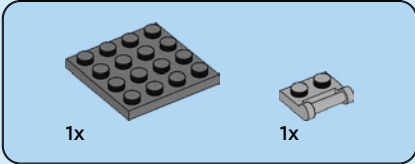
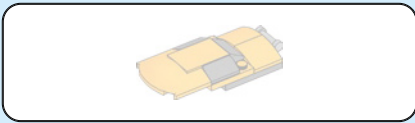

88

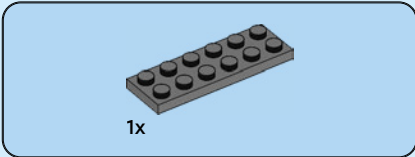
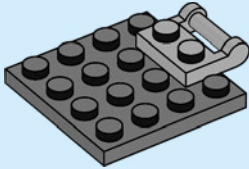

89

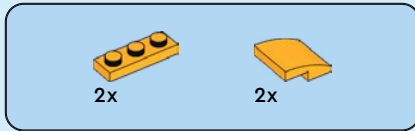
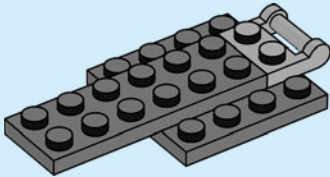

90

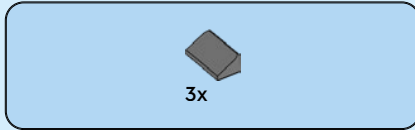
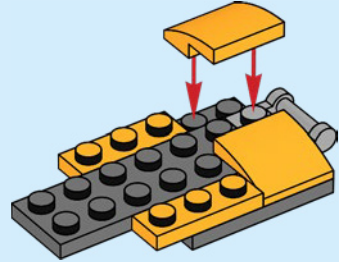

91

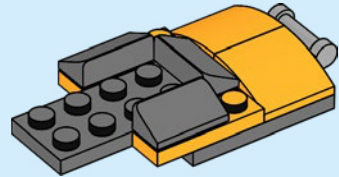



1x

92

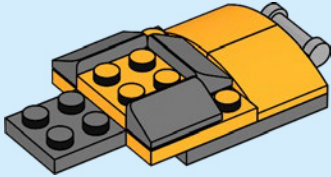

1x

93

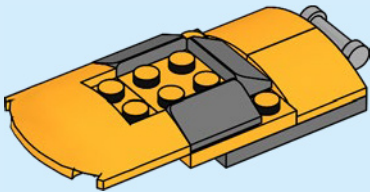

1x

94

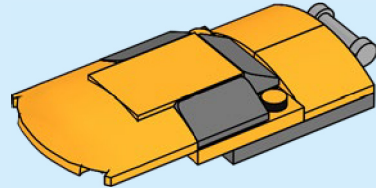

95

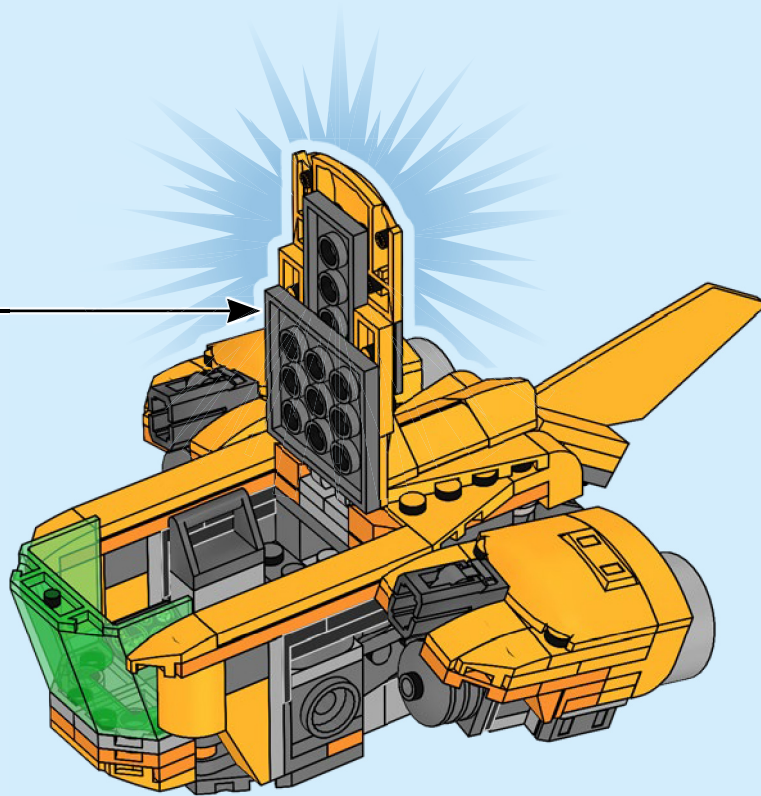

96

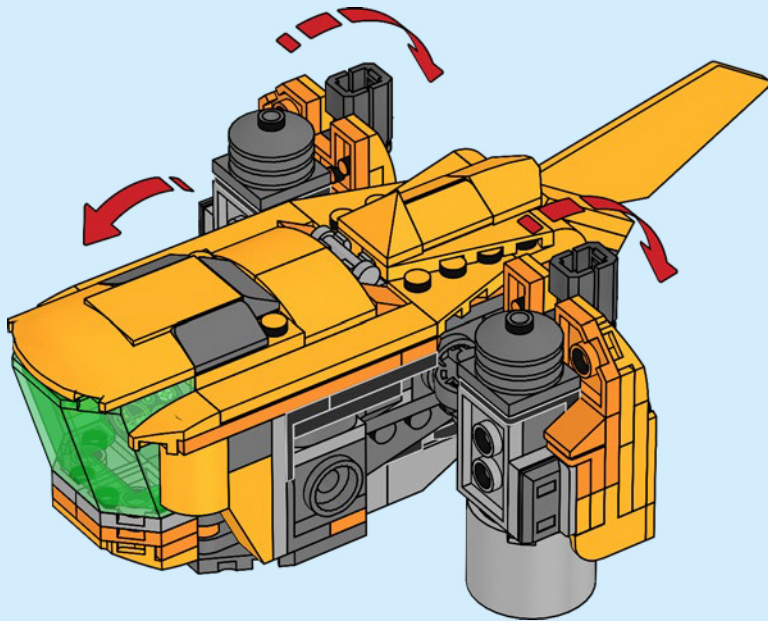





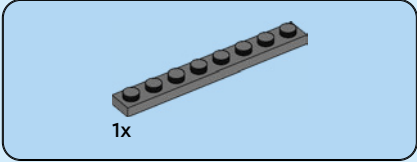
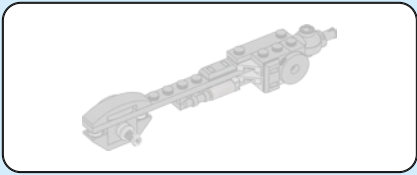

97

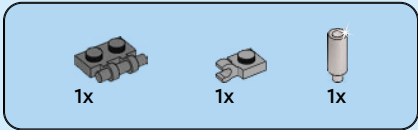
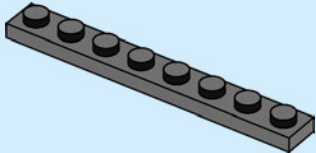

98

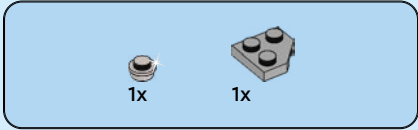
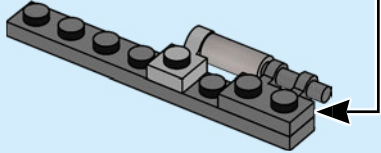
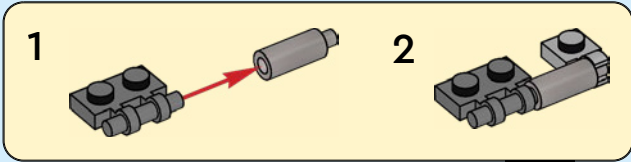

99

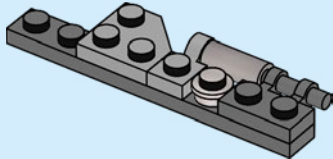

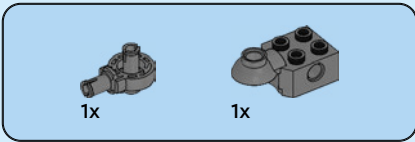

100

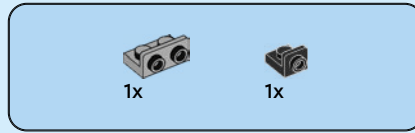
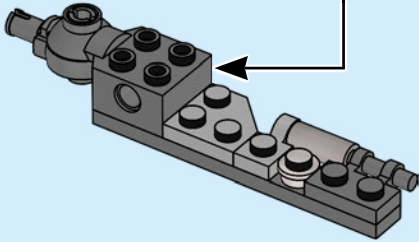
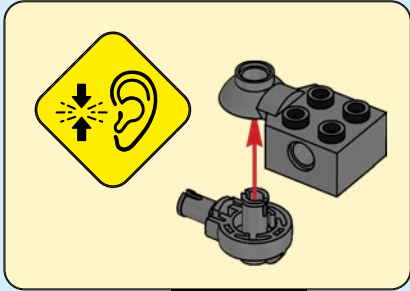

101

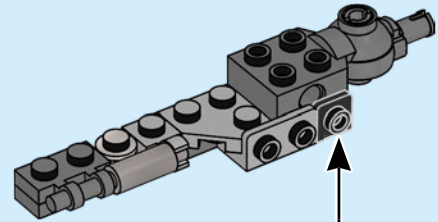
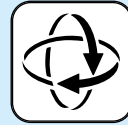

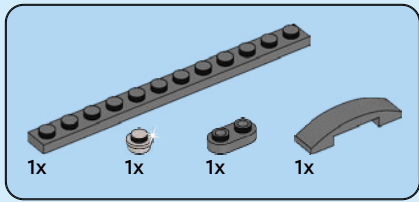

102

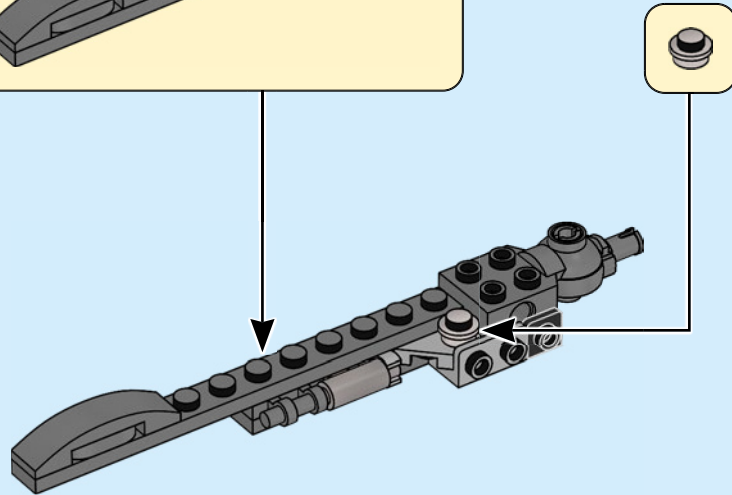
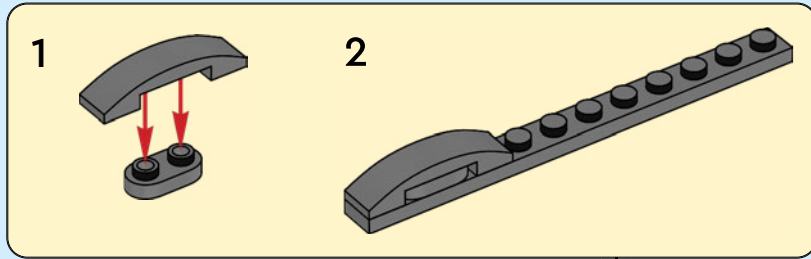



1x



1x

# 103

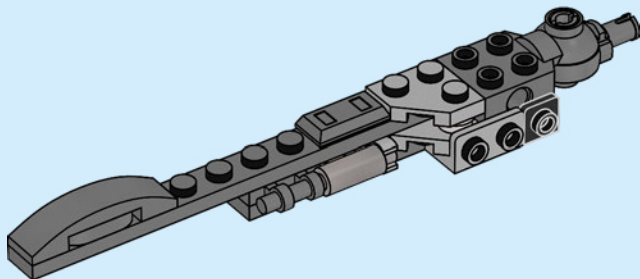

1x



1x



1x

# 104

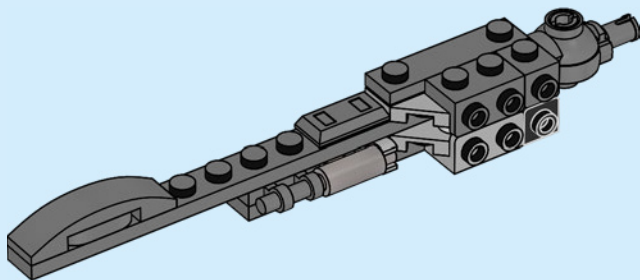

1x



1x

# 105

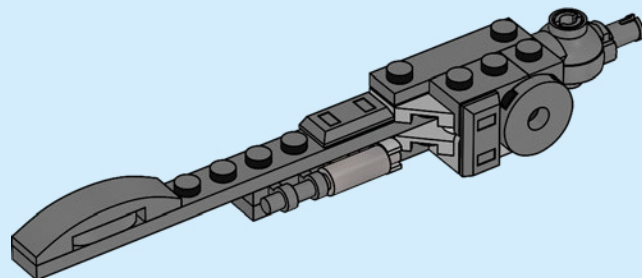

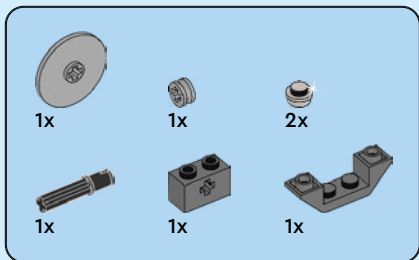

106

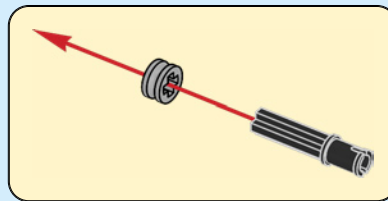

1

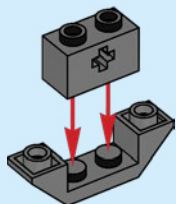

2

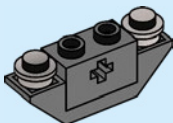

3

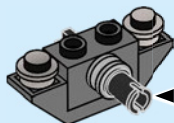

4

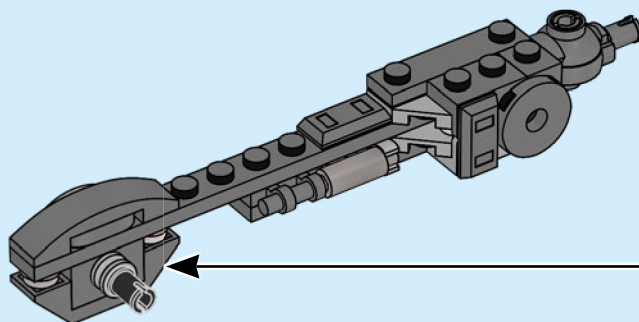
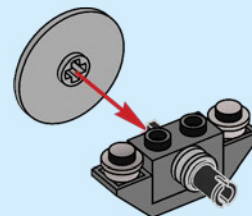

107

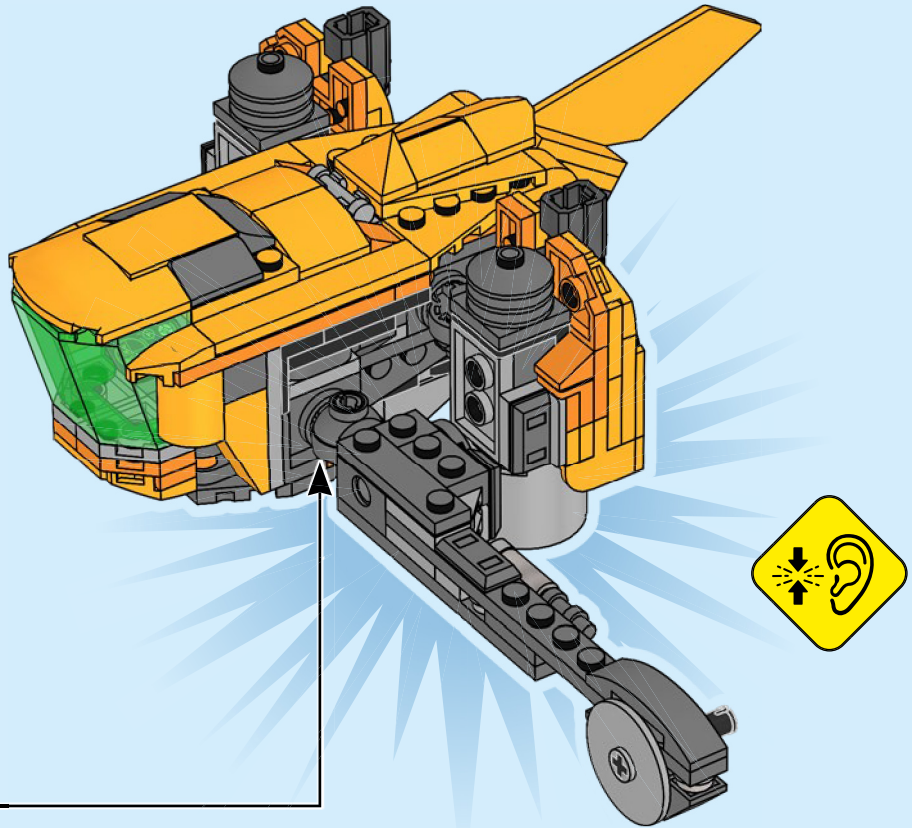

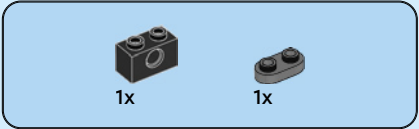

108

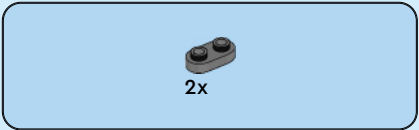
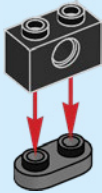

109

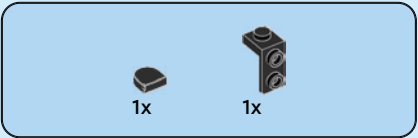
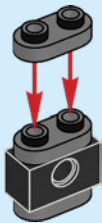

110

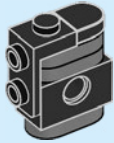



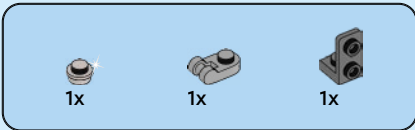

111

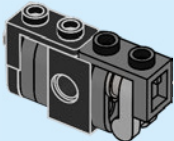
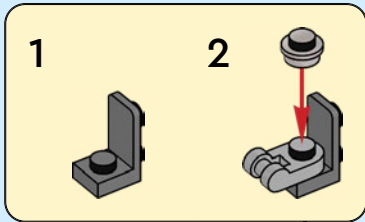

112

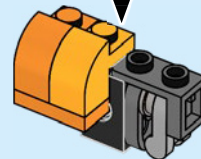
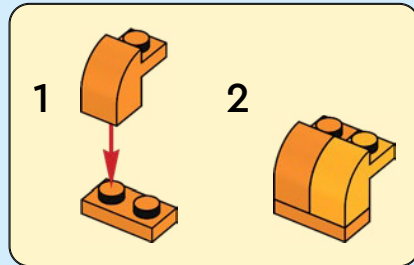



2x

# 113

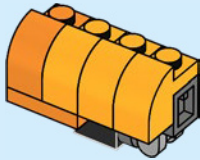

1x



1x

# 114

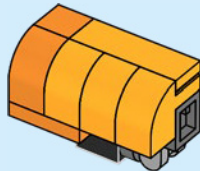

1x



1x



1x

# 115

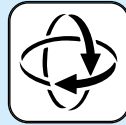

1

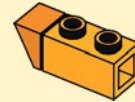

2

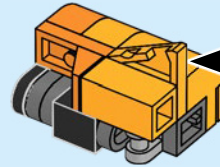
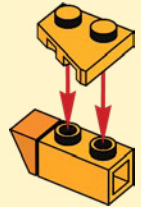

2x



1x

# 116

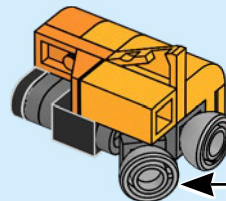

117

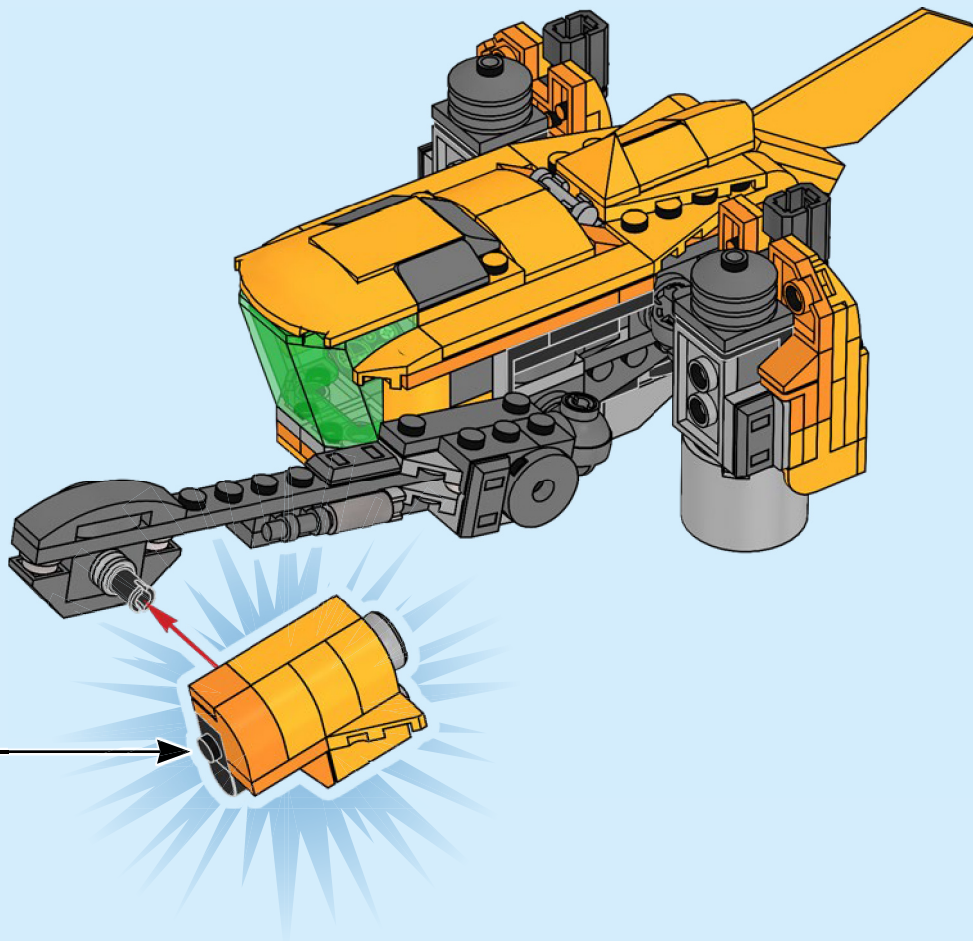

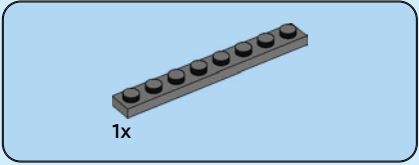
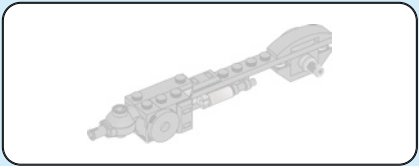

1x

# 118

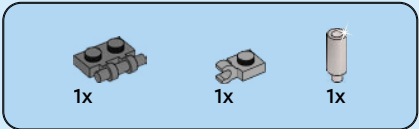
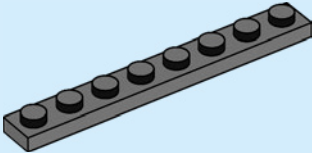

1x

1x

1x

# 119

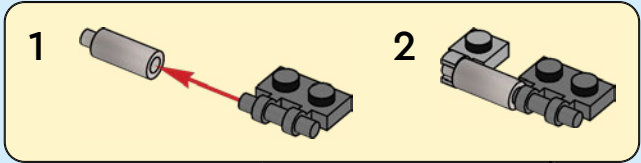

1

2

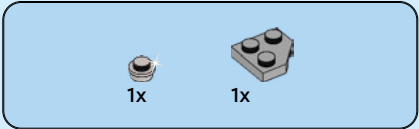
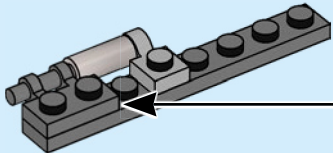

1x

1x

# 120

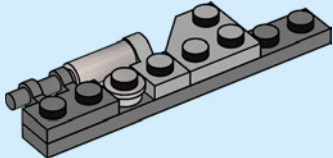

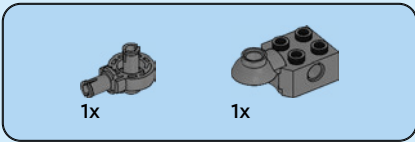

121

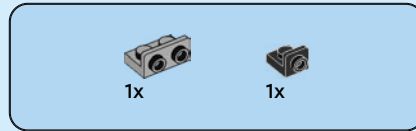
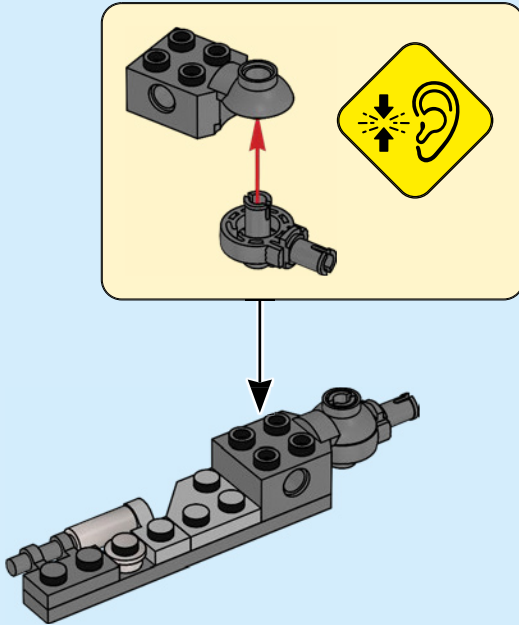

122

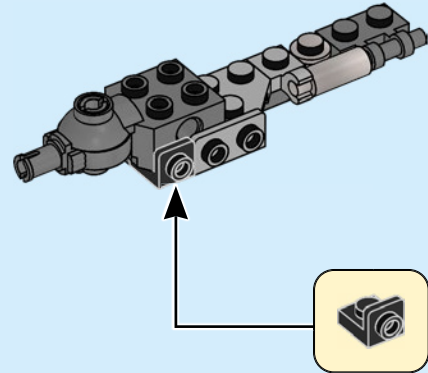

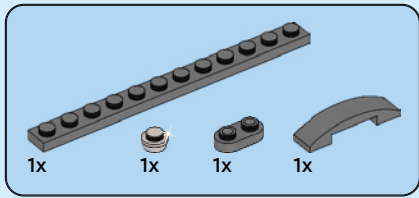

123

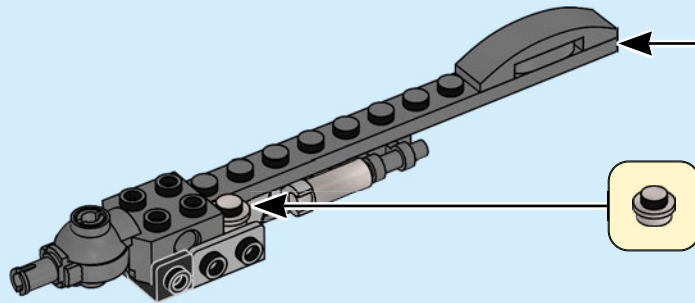
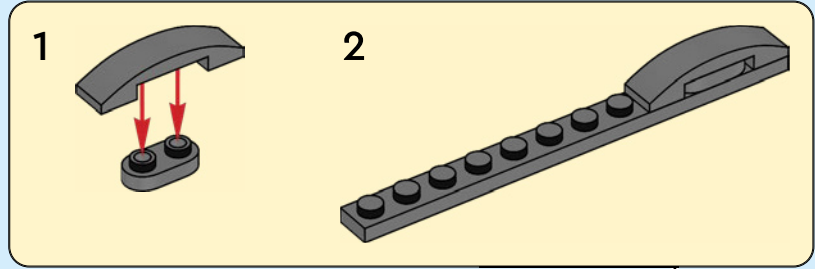



1x



1x

# 124

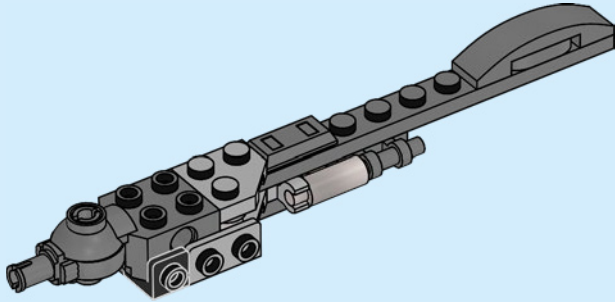

1x

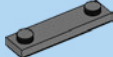

1x



1x

# 125

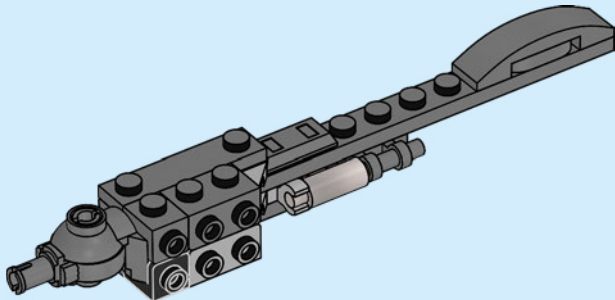

1x



1x

# 126

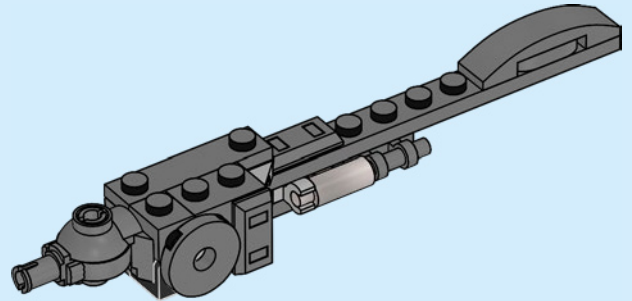

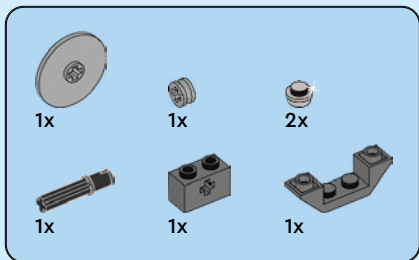

127

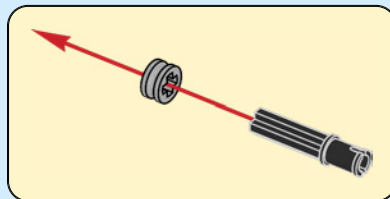

1

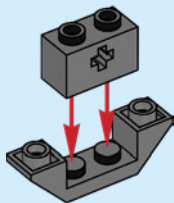

2

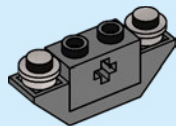

3

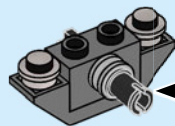

4

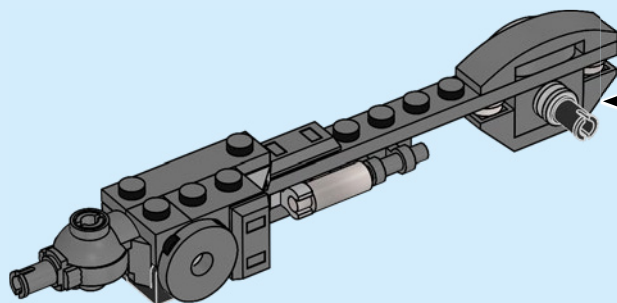
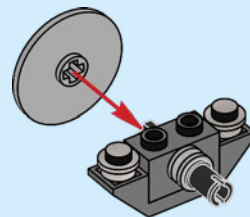



128

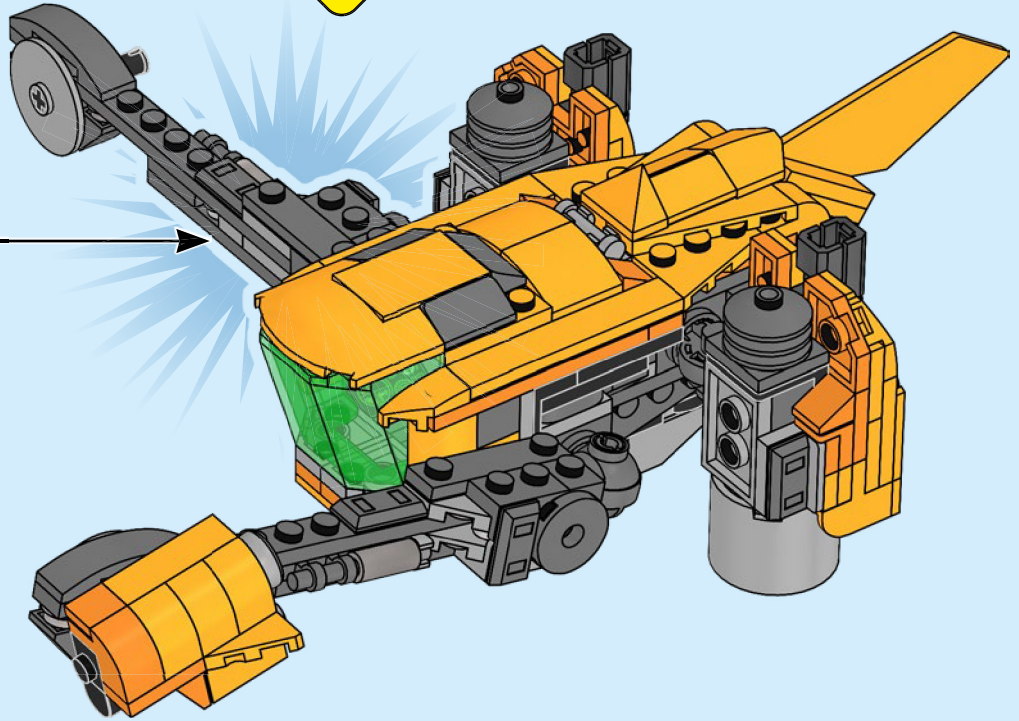

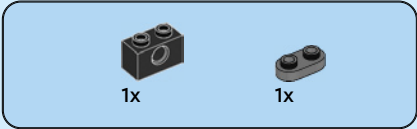

129

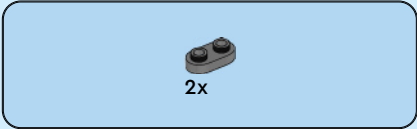
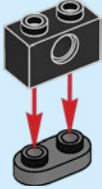

130

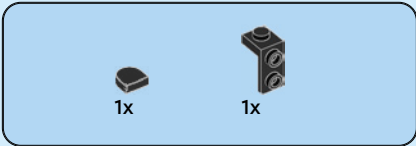
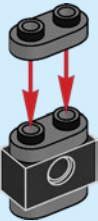

131

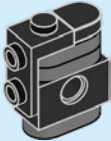



132

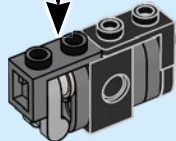
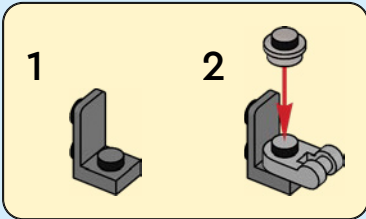

133

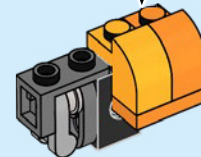
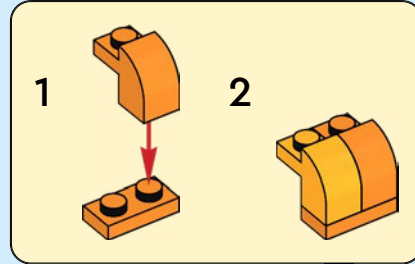



2x

# 134

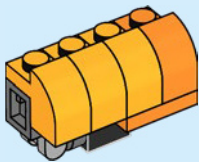

1x



1x

# 135

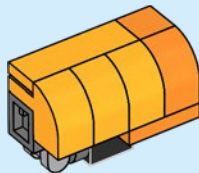

1x



1x



1x

# 136

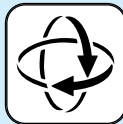

1



2

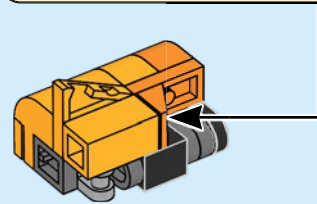
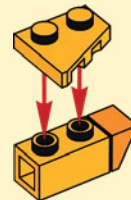

2x



1x

# 137

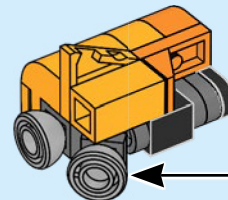

138

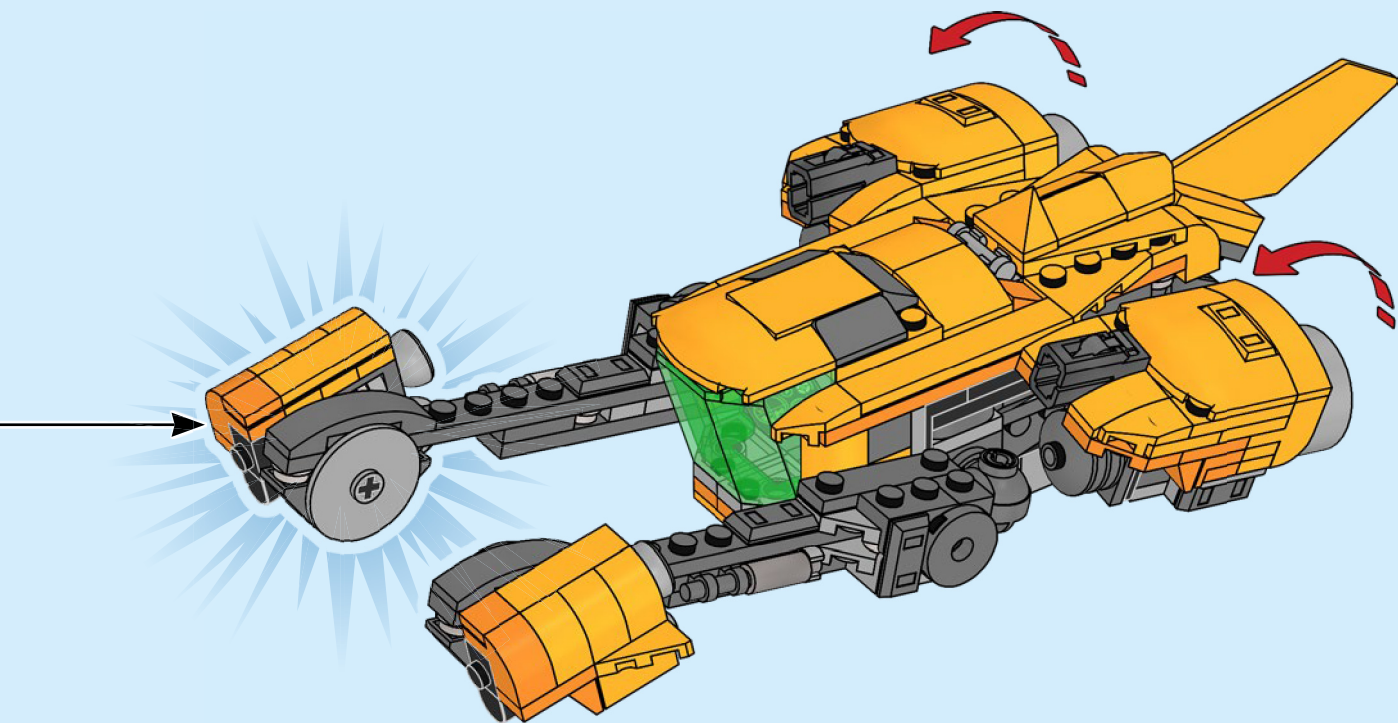



4x



139

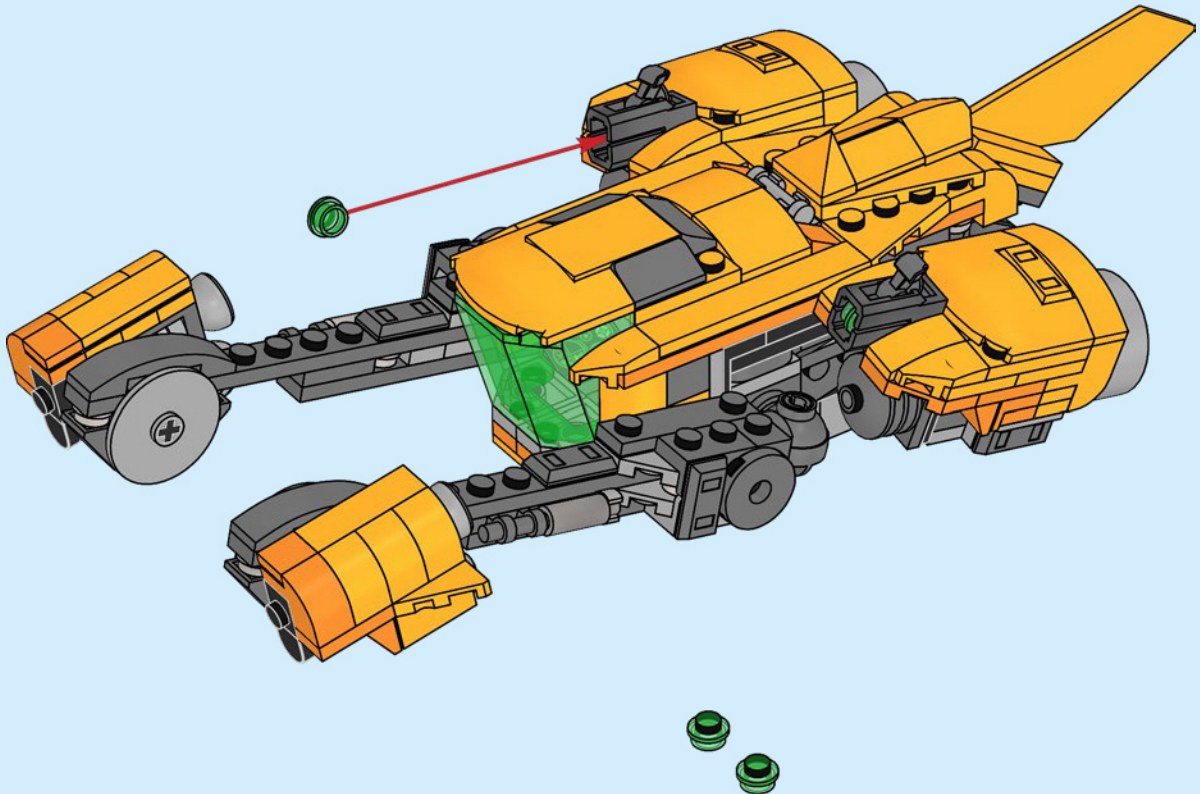

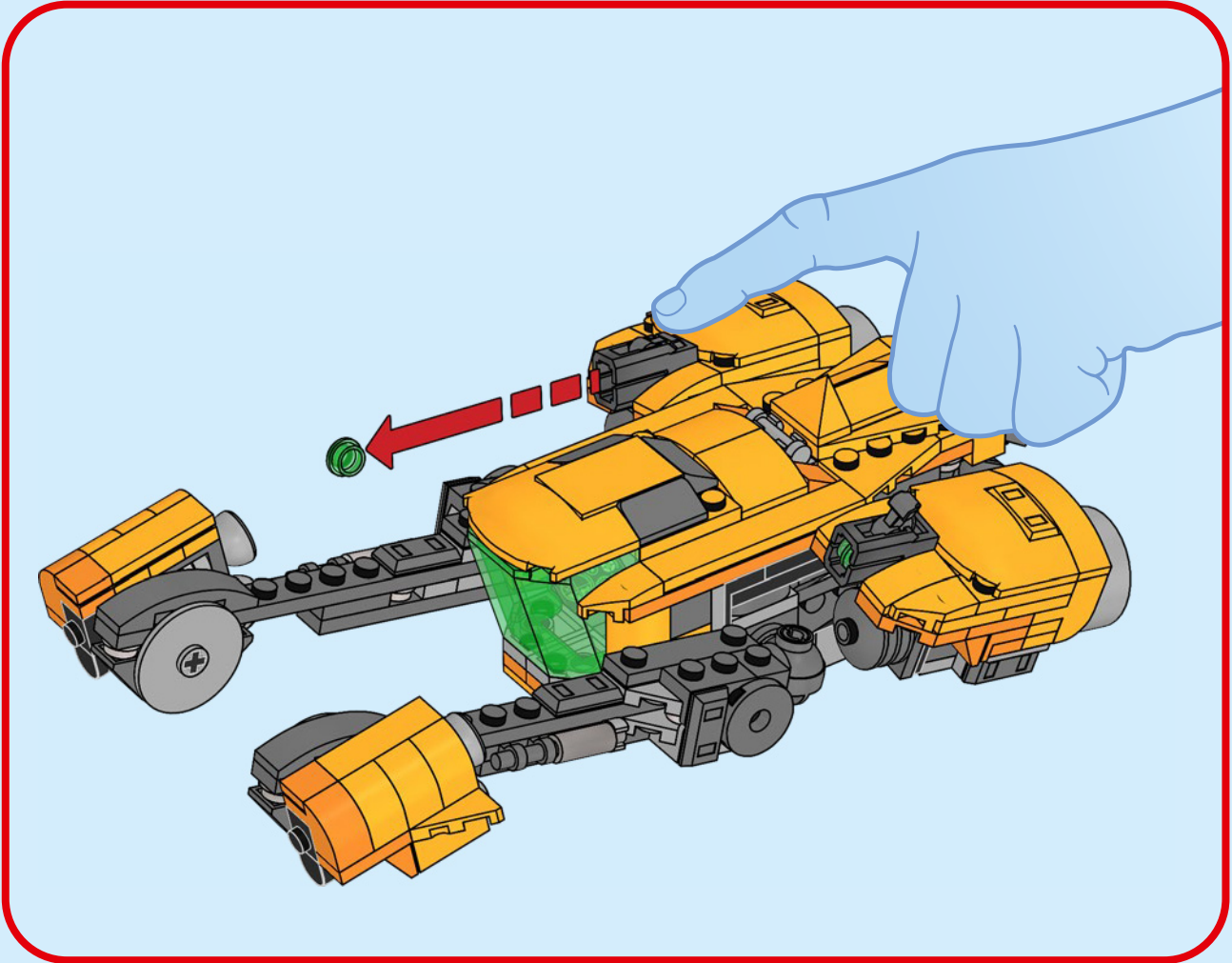

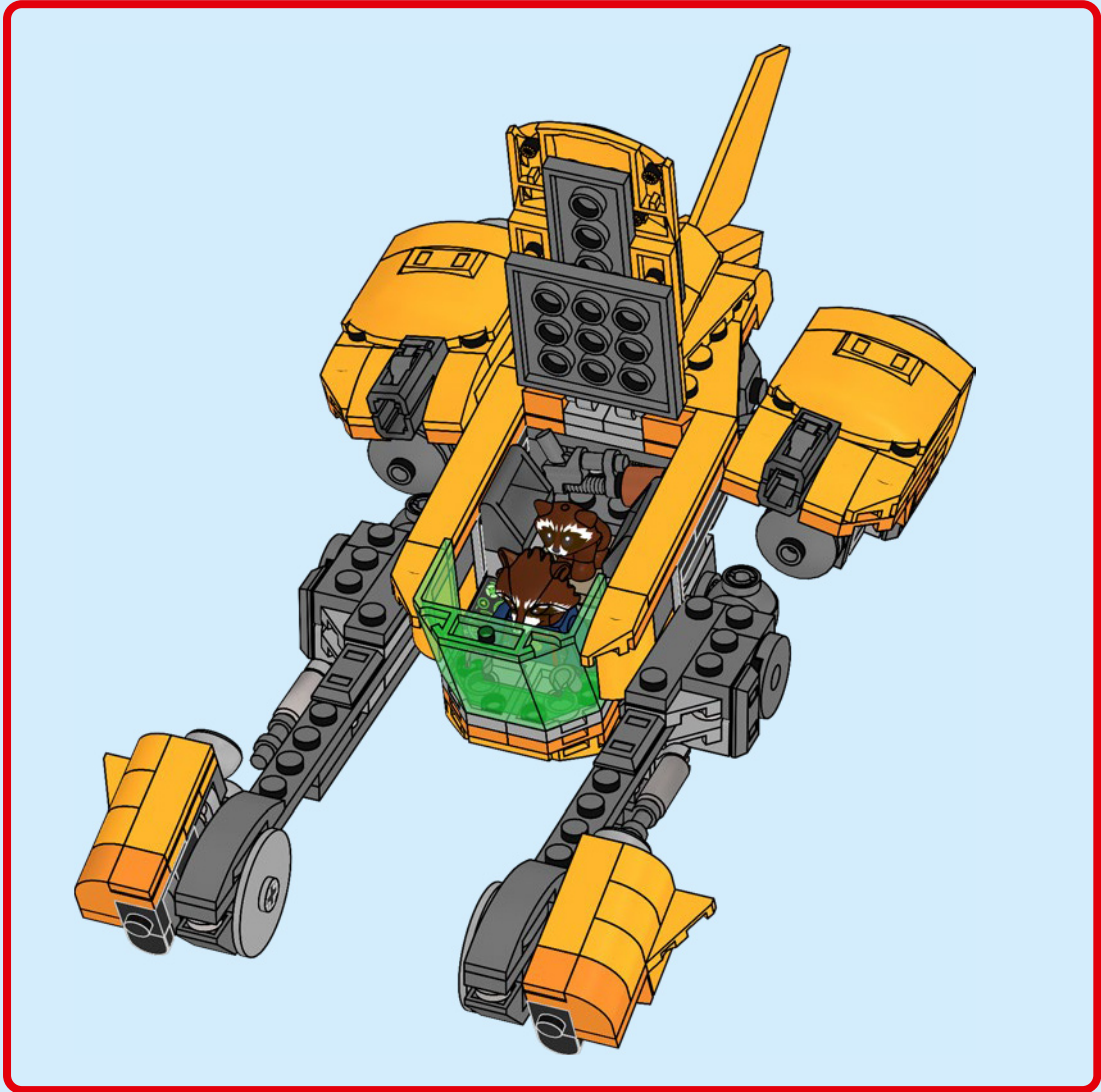





 2x  
6278152

 2x  
6256435

 4x  
6380236

 2x  
6234695

 2x  
6336977

 3x  
403226

 2x  
370026

 6x  
6117973

 2x  
6089119

 4x  
362326

 1x  
302026

 1x  
6039194

 3x  
6245307

74

 2x  
6325978

 4x  
6213777

 1x  
6249417

 1x  
6126075

 1x  
4530129

 1x  
64444338

 3x  
6289747

 2x  
6328096

 1x  
6296241

 1x  
6328059

 1x  
6020145

 1x  
6227663

 1x  
6227662

 1x  
6020146

 3x  
6289745

 2x  
6024286

 1x  
6382584

 2x  
6334836

 7x  
6028736

 2x  
6236454

 4x  
6099728

 8x  
6374487

 1x  
6400434

 3x  
6099730

 6x  
6003033

 2x  
6131583

 6x  
6073042

 2x  
6099725

 1x  
6286881

 2x  
6020073

 2x  
6133826

 3x  
6218142

 2x  
6421680

 2x  
6365966

 1x  
6307483

 1x  
6442581

 1x  
6404147

 1x  
6337817

 2x  
6326078

 6x  
6186657

 4x  
6004990

 2x  
4667578

 1x  
4244627

 1x  
4211881

 2x  
6267048

 2x  
6270081

 2x  
6326483

 2x  
6435930

 2x  
6271165

 2x  
6347992

 4x  
6221784

 2x  
6353378

 2x  
6225246

 1x  
4278273

 3x  
4211396

 3x  
4211445

 1x  
4211385

 4x  
6240221

 1x  
6435795

6x  
4504371

2x  
4524929

2x  
4558595

2x  
6403225

2x  
6352223

6x  
6218367

2x  
6411362

2x  
4177932

2x  
6106027

2x  
6147047

2x  
4158355

3x  
4173332

2x  
6397633

4x  
4211098

2x  
6344022

2x  
6360675

4x  
6336390

2x  
6413106

13x  
6221607

2x  
6390673

1x  
4210782

2x  
6214341

2x  
6308045

1x  
4210788

1x  
4623236

2x  
6194290

3x  
4567887

6x  
4211010

5x  
6055313

4x  
6398662

1x  
4211066

7x  
6331866

2x  
4211096

2x  
6178919

2x  
4210660

4x  
4522784

2x  
6266225

2x  
4210646

2x  
4210635

2x  
6126083

2x  
4210725

2x  
4648256

2x  
6257592

2x  
6185675

2x  
6279898

2x  
6343337

1x  
4294180

3x  
4243831

1x  
4211002

1x  
4521572

2x  
4210998

2x  
6133611

1x  
6074890

2x  
6336564

14x  
4633691

3x  
6158368

2x  
6345952



 [LEGO.com/service](https://www.LEGO.com/service)

YOU COULD **WIN**



Scan this QR code or go to **LEGO.COM/PRODUCTFEEDBACK** and give us your short feedback about this LEGO® set for a chance to win a cool LEGO prize.

Terms and Conditions apply\*

**DE: Du könntest GEWINNEN.** Es gelten die Teilnahmebedingungen\* **FR: Tu pourrais GAGNER.** Des conditions s'appliquent\* **IT: Potresti VINCERE tu.** Termini e condizioni sono applicabili\* **ES: Puedes GANAR.** Aplican términos y condiciones\* **PT: Poderá GANHAR.** Aplicam-se termos e condições\* **JA: プレゼント付き! 利用規約が適用されます\*** **ZH: 轻松获奖. 条款和条件适用\*** **KO: 상품의 주인이 되어보세요. 소정의 약관이 적용됩니다\*** **RU: Вы можете ВЫИГРАТЬ.** Действуют положения и условия\* **PL: Szansa na WYGRANĄ.** Obowiązują warunki korzystania\* **CS: Máte šanci VYHRÁT.** Platí všeobecné smluvní podmínky\* **SK: Máte šancu VYHRAŤ.** Platia všeobecné zmluvné podmienky\* **HU: TE IS NYERHETSZ.** Felhasználási feltételek érvényesek\* **RO: Ai putea CÂȘTIGA.** Se aplică termeni și condiții\* **BG: Можете да СПЕЧЕЛИТЕ.** Има определени правила и условия\* **LV: Tu vari LAIMĒT.** Ir spēkā noteikumi un nosacījumi.\* **ET: Sul on võimalus VÕITA.** Kehtivad tingimused\* **LT: Jūs galite LAIMĖTI.** Taikomos sąlygos\*  
\*LEGO.com/productfeedback-terms