



76958





LEGO.com/sustainable-packaging



BUILDER



Apple and the Apple logo are trademarks of Apple Inc., registered in the U.S. and other countries and regions. App Store is a service mark of Apple Inc. Google Play and the Google Play logo are trademarks of Google LLC. Tencent and the Tencent logo are trademarks of Tencent Inc.

Q [LEGO.com/devicecheck](https://www.lego.com/devicecheck)

EN Ask parents' permission before going online | **DE** Eltern um Erlaubnis bitten, bevor du online gehst | **FR** Demande l'autorisation d'un parent avant d'aller en ligne | **IT** Chiedi il permesso ai tuoi genitori prima di andare online | **ES** Pídeles permiso a tus papás antes de conectarte a Internet | **PT** Pede autorização aos pais antes de acederes online | **ZH** 上网前应先征得父母的同意 | **PL** Poproś rodziców o zgodę, zanim wejdiesz do Internetu | **CS** Než půjdeš na internet, požádej rodiče o svolení | **SK** Skôr než pôjdeš na internet, vypýtaj si povolenie od rodičov | **HU** Kérj szülői engedélyt, mielőtt online csatlakoznál! | **RO** Cere permisiunea părinților înainte de a te conecta online | **BG** Поискайте разрешение от родител, преди да влезете онлайн | **LV** Pirms došanās tiešsaistē palūdz atļauju vecākiem | **ET** Enne Interneti kasutamist küsi vanematelt luba | **LT** Prieš prisijungdami prie interneto, atsiklauskite tėvų

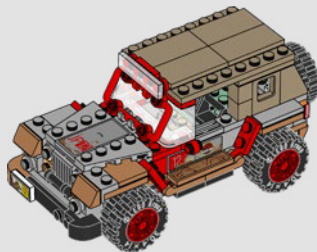
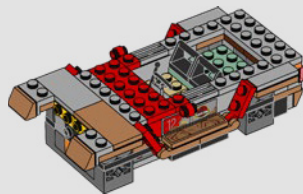

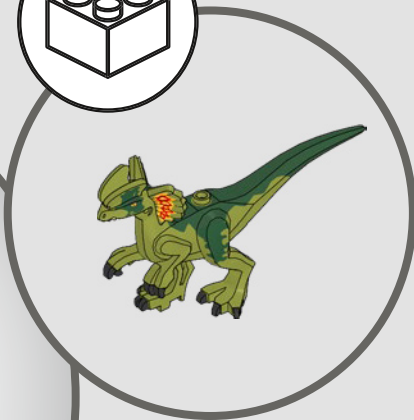
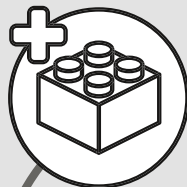

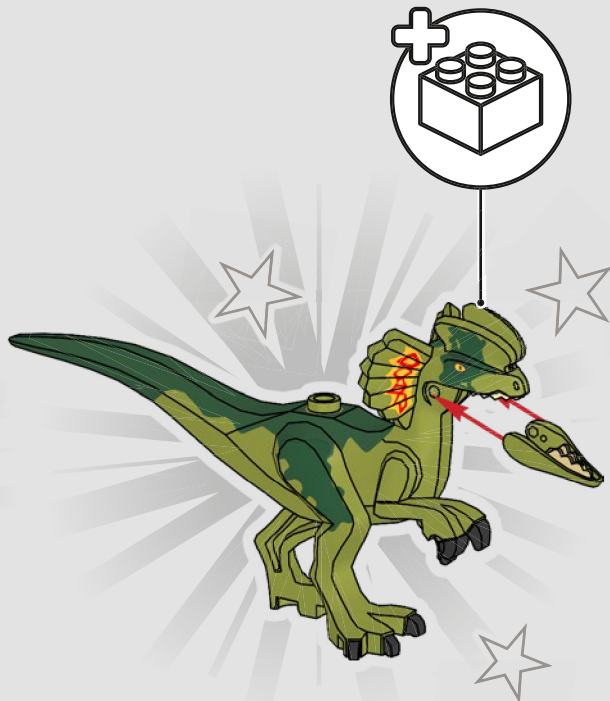
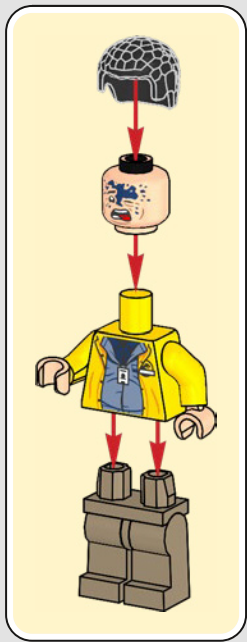

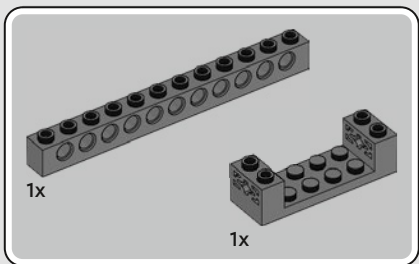
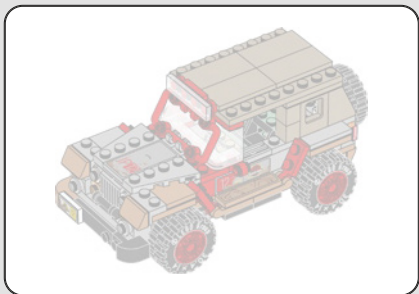

1

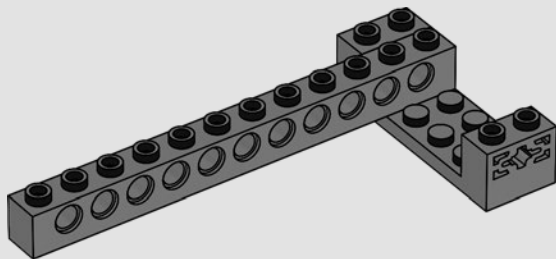

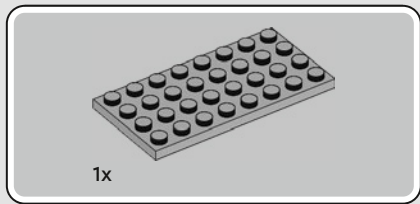

2

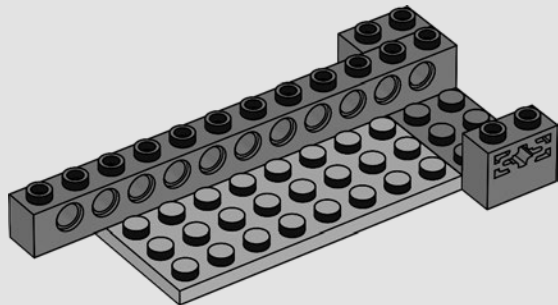

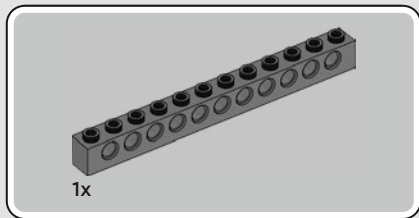

3

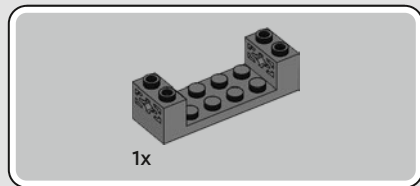
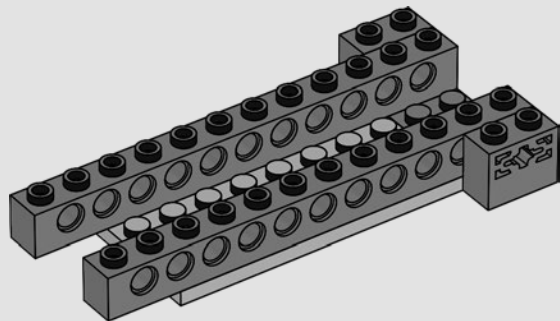

4

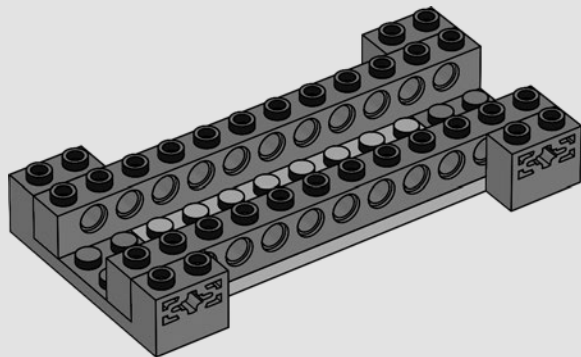

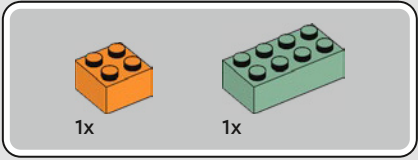

5

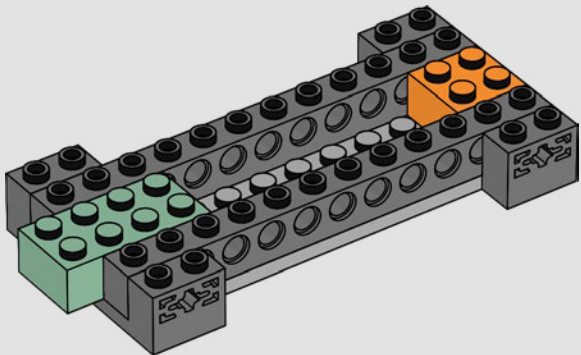



1x

6

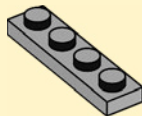
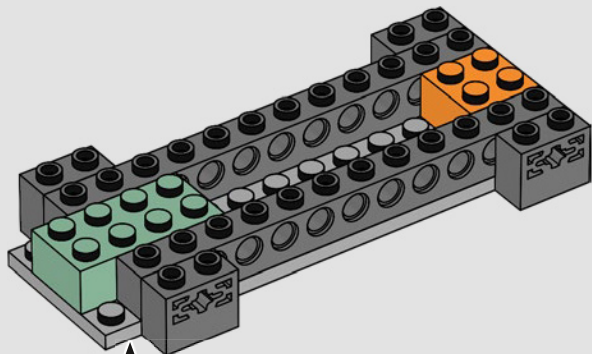

2x

7

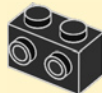
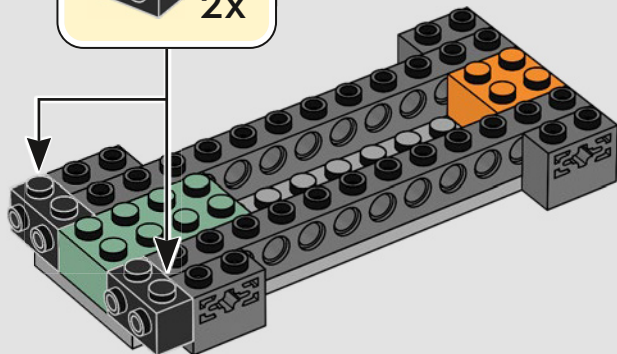

2x

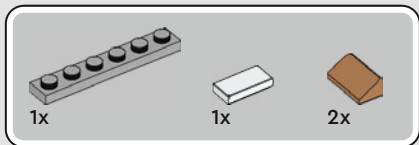

8

1

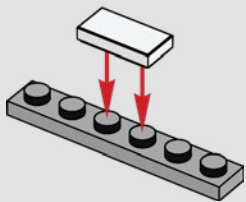

2

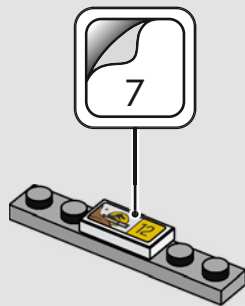

3

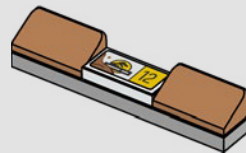



4

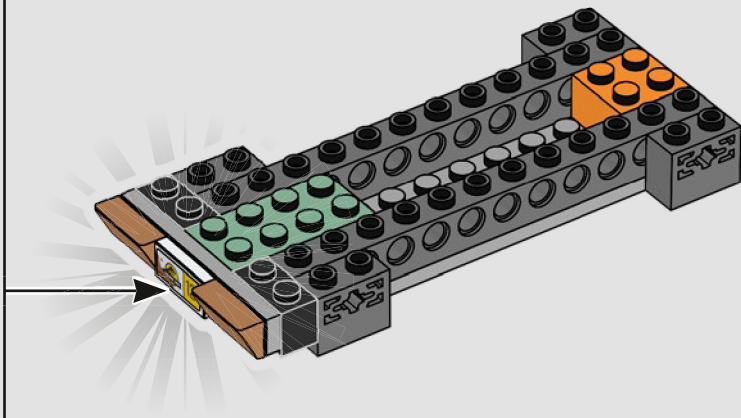



2x

10

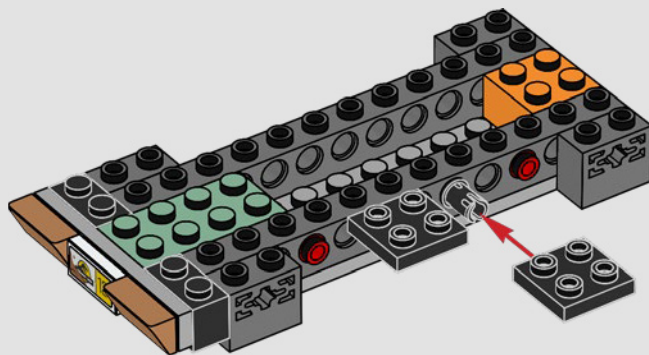



2x



2x

11

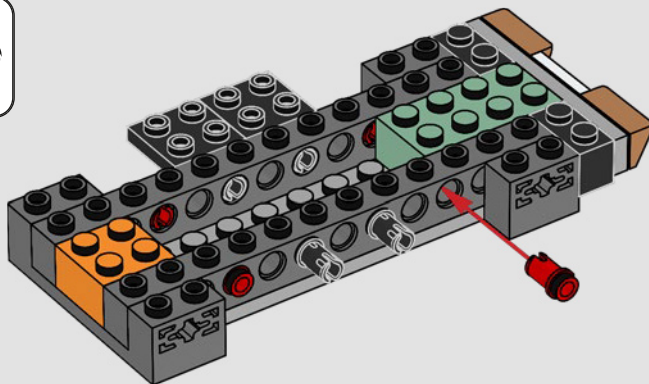



2x

12

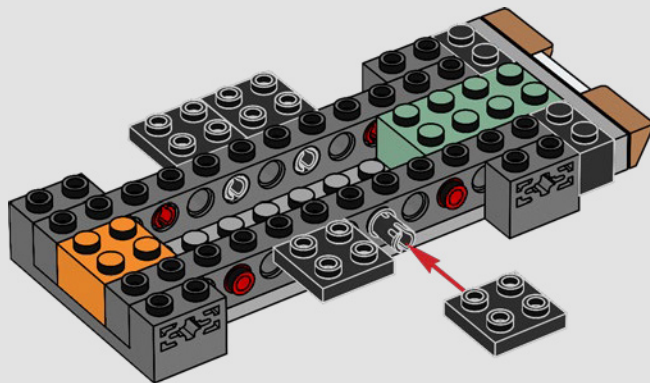

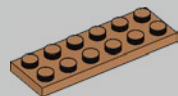

1x

13

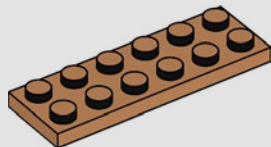

1x



1x

14

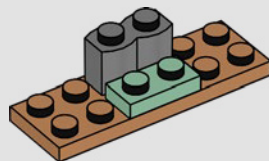



2x

15

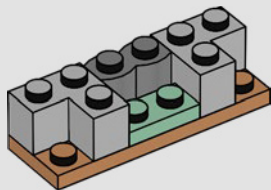

2x



2x

16

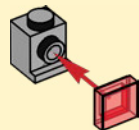

2x

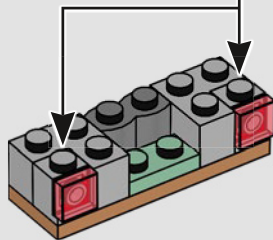



1x

17

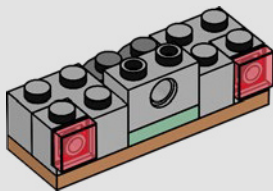

2x

18

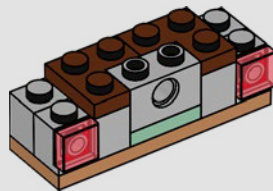



2x

19

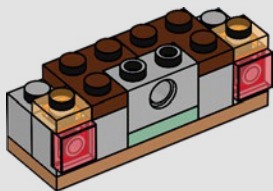

20

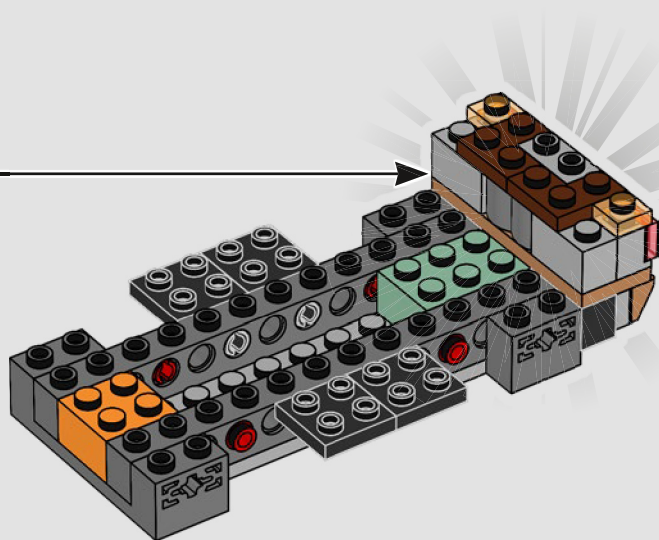

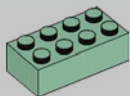

2x

21

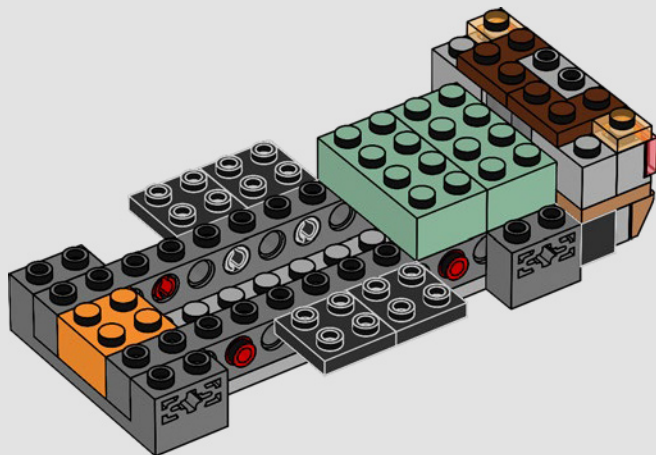



2x

23

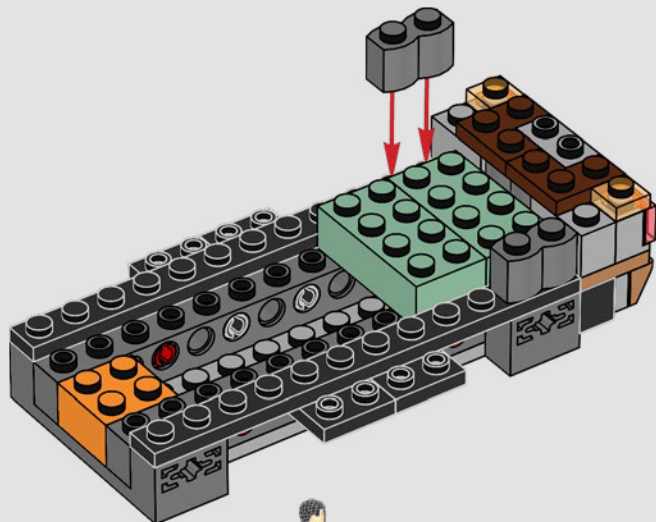

24



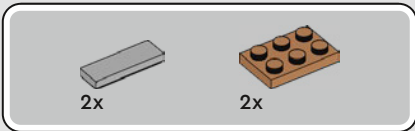

24

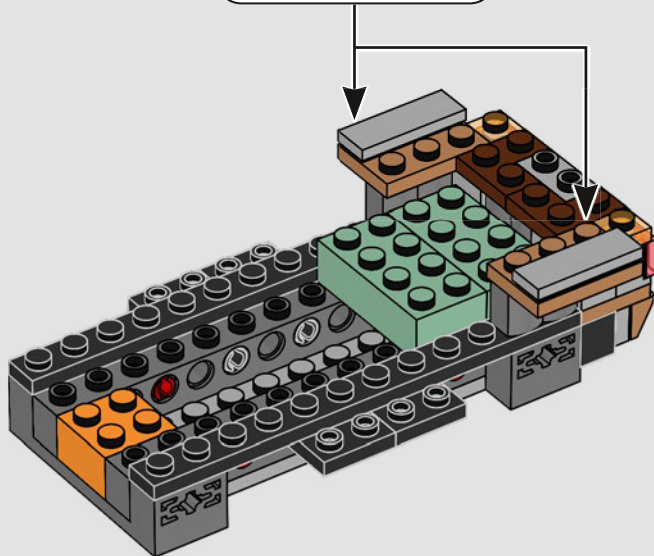
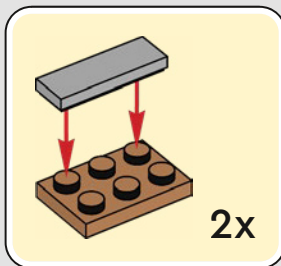



1x

25

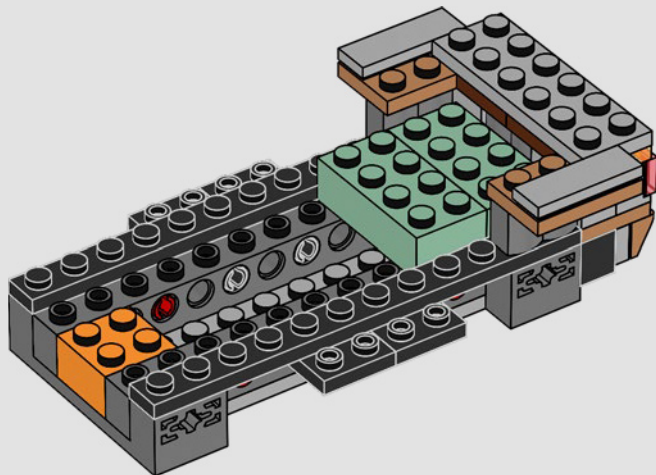

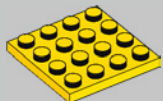

1x

26

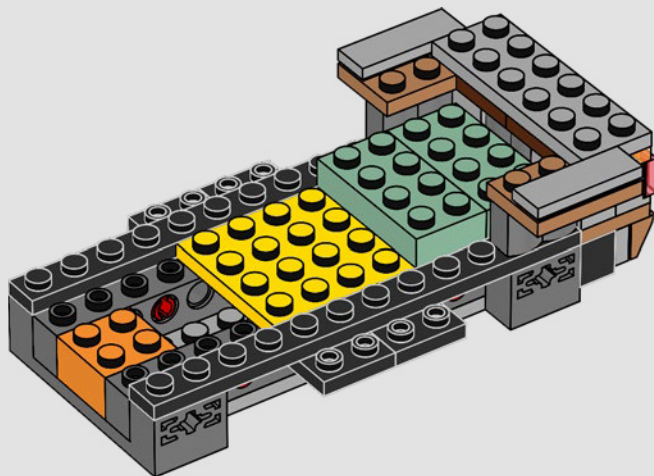



2x



2x

27

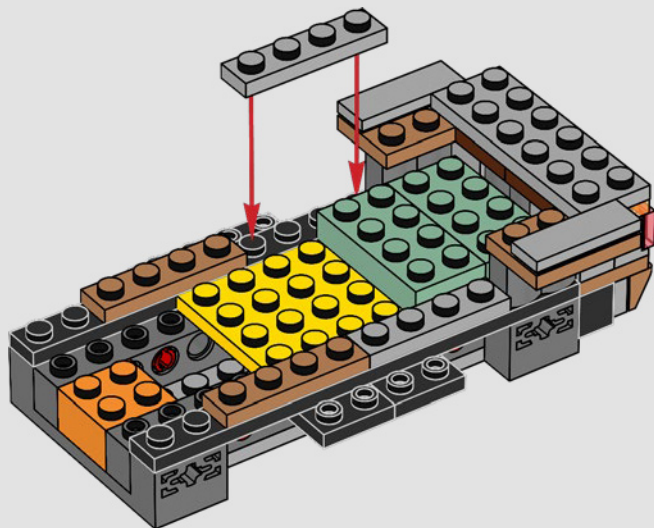



2x

28

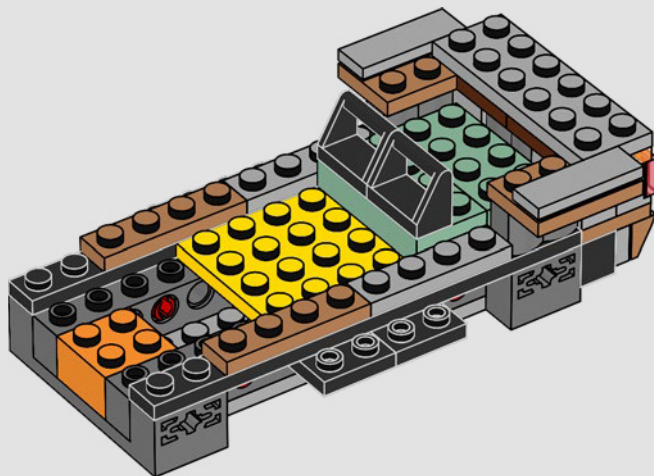



2x

29

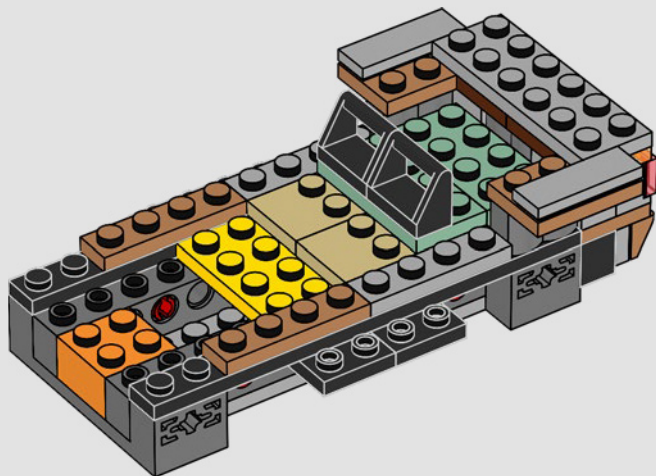



1x

30

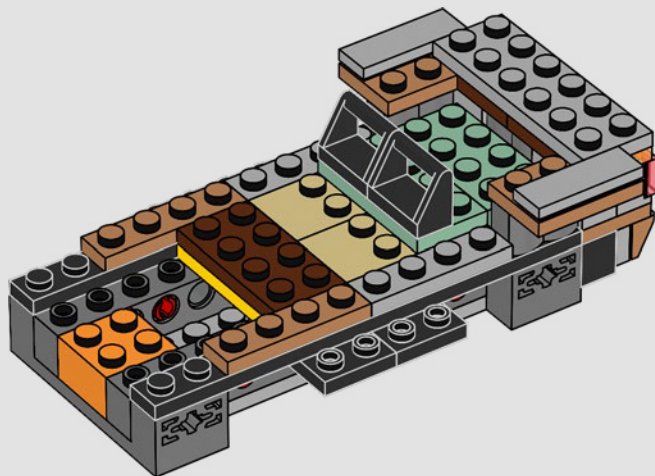

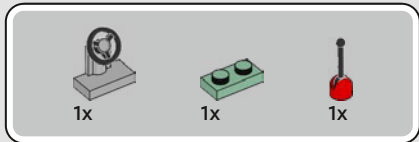

31

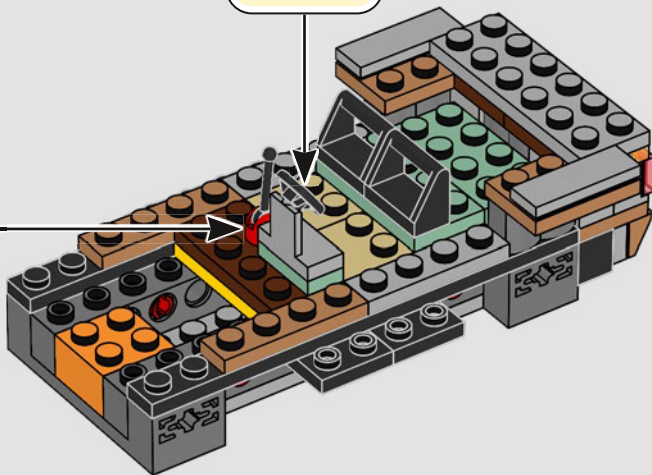
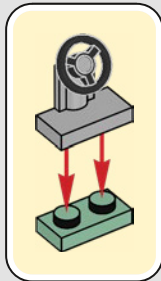

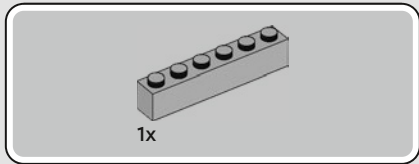

33

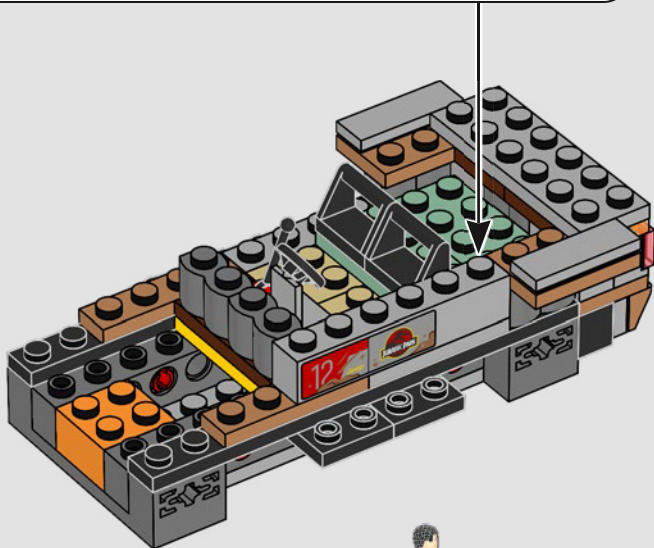
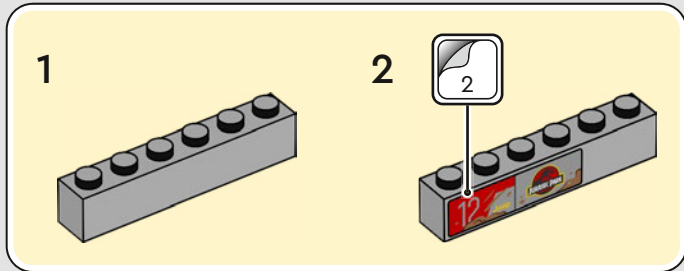

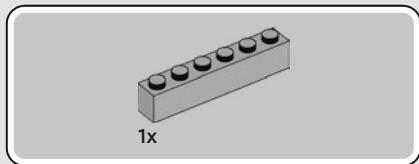

34

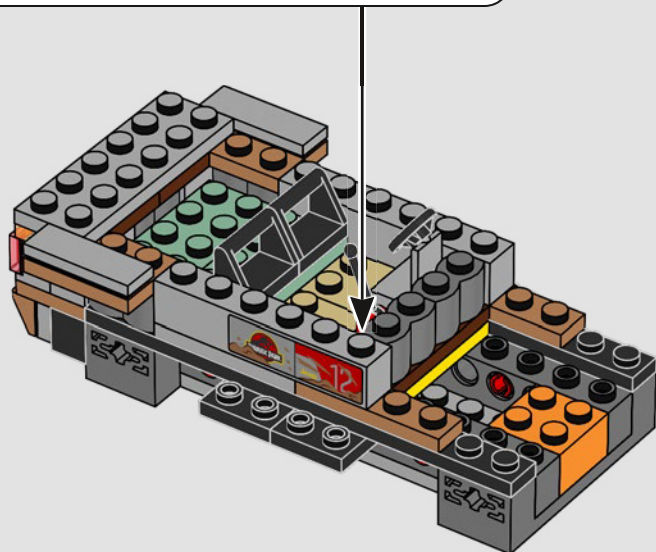
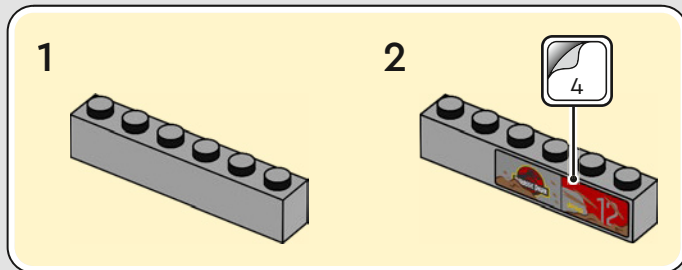



1x

35

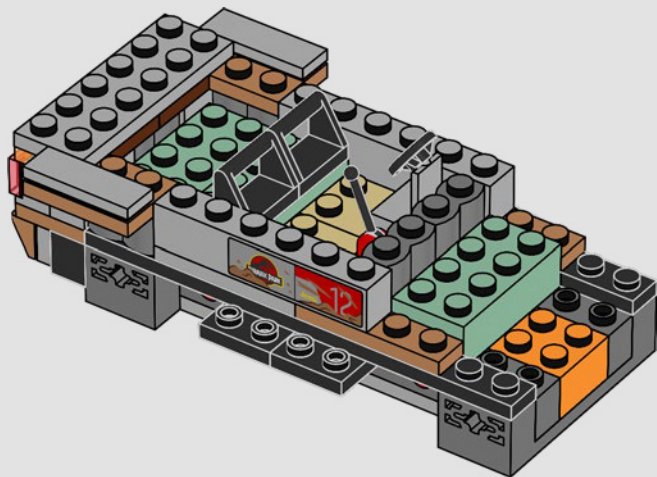



2x

36

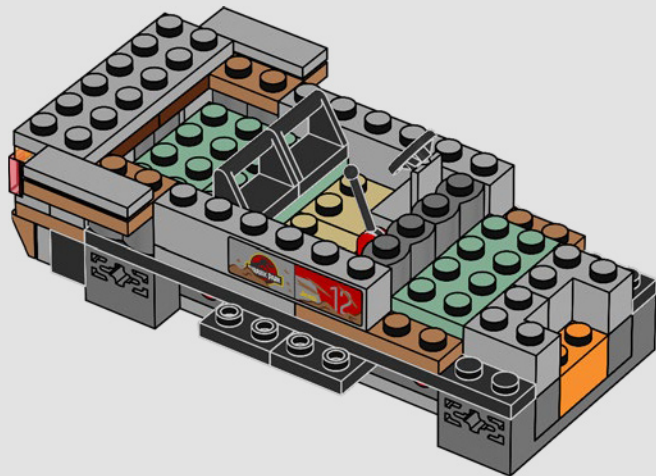



1x

37

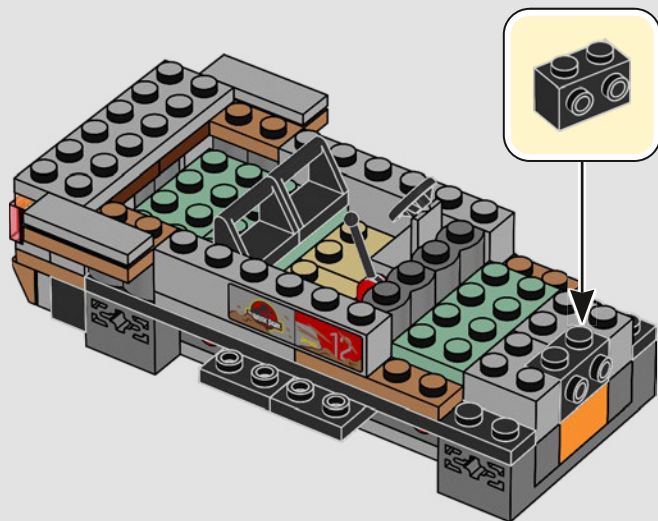



1x



1x

38

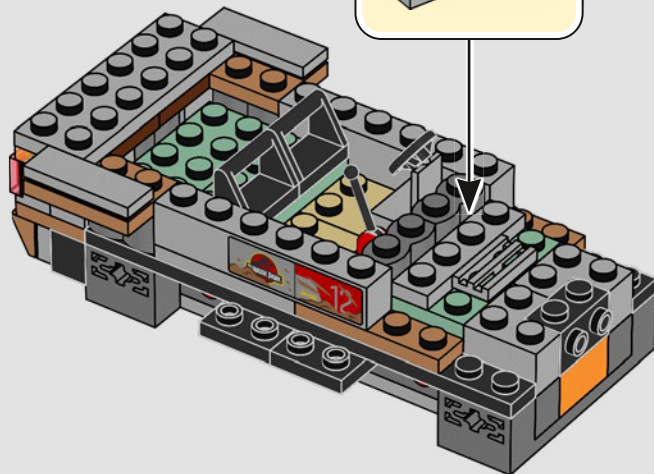
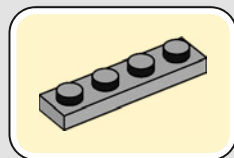



2x



2x

39

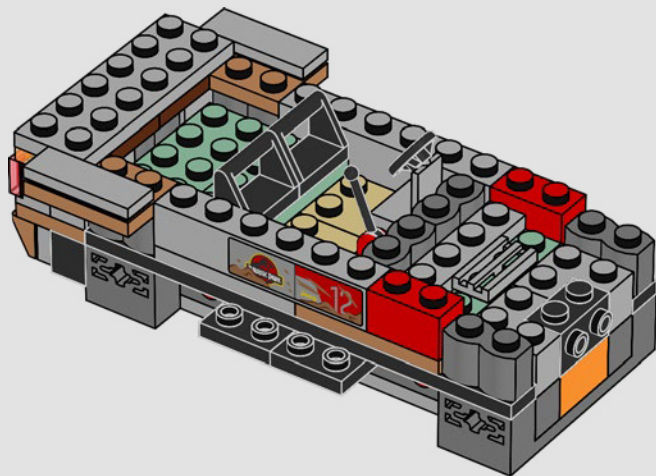



2x

40

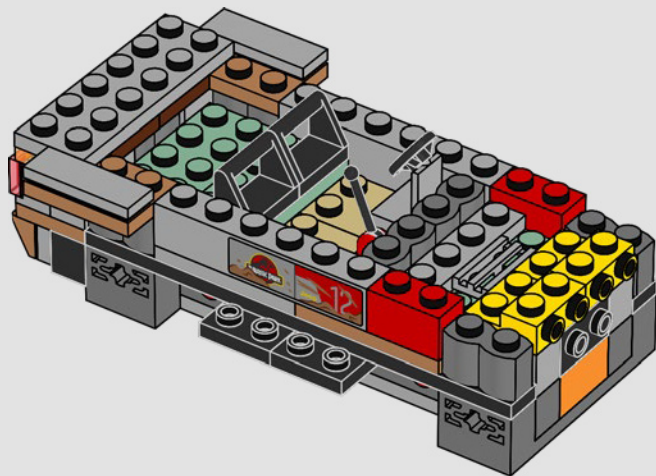



2x

41

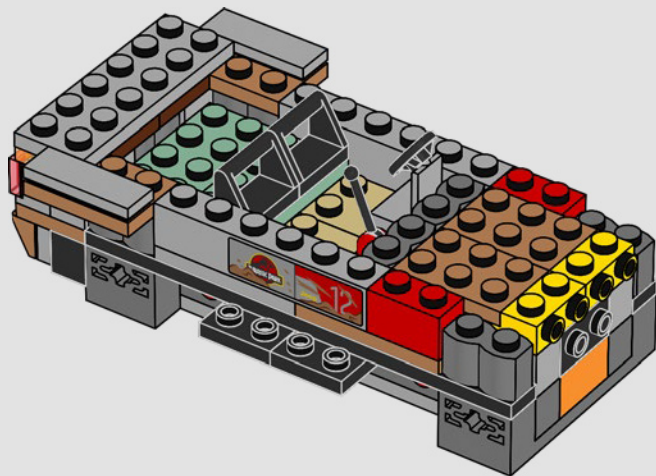

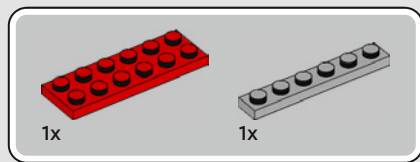

42

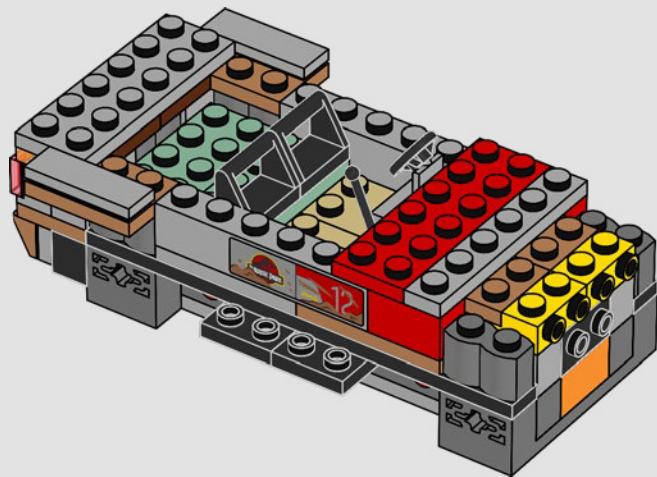



2x

43

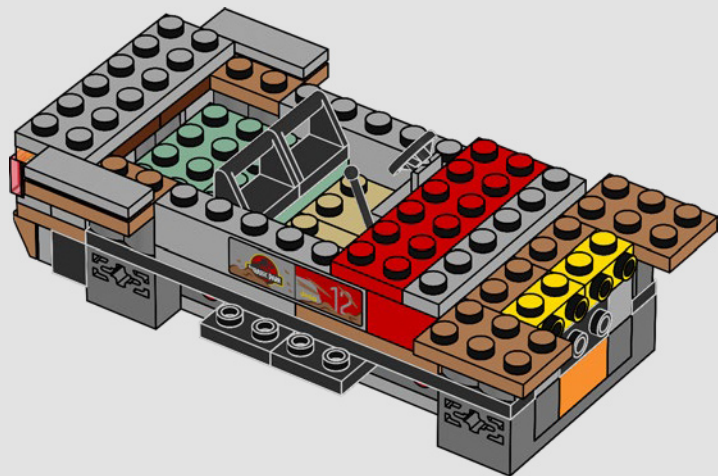

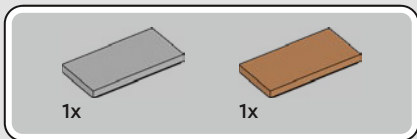

44

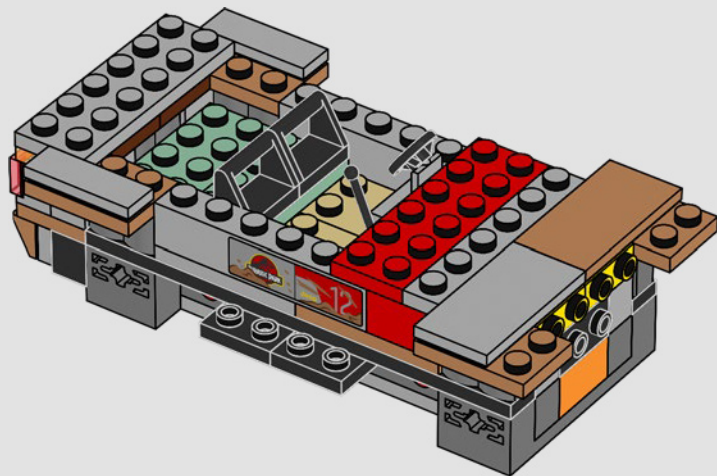



2x

45

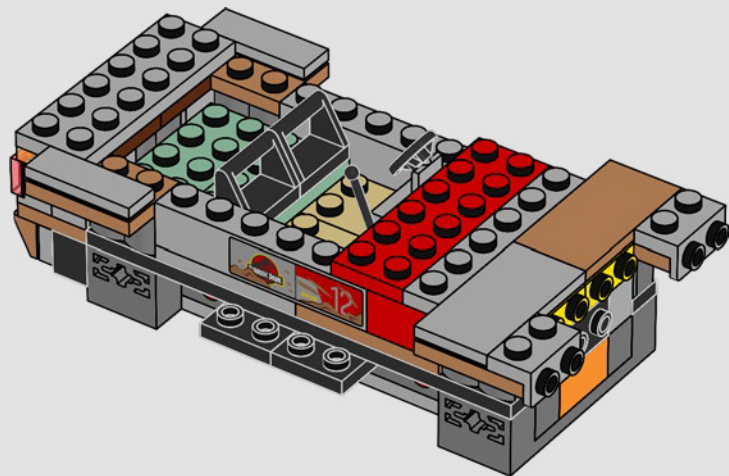



2x

46

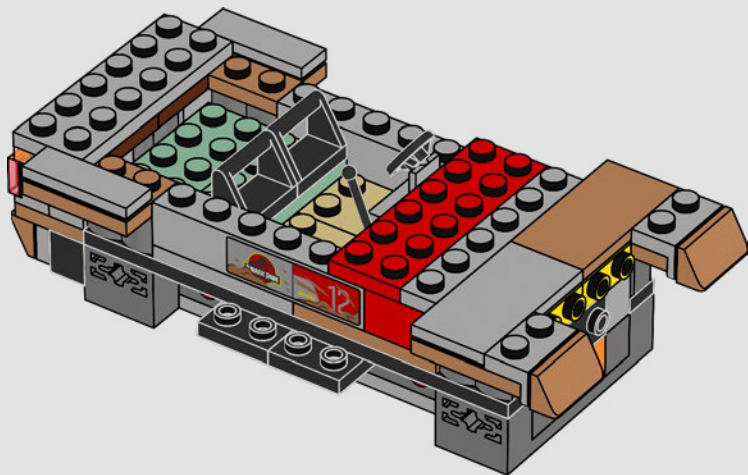

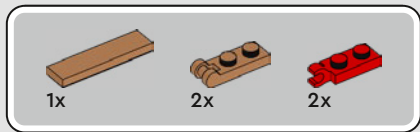

47

1

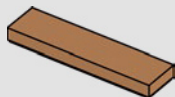

2

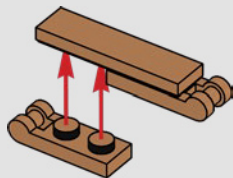

3

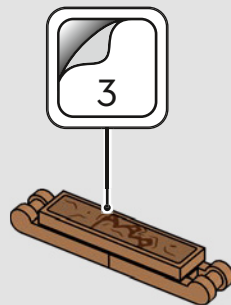

4

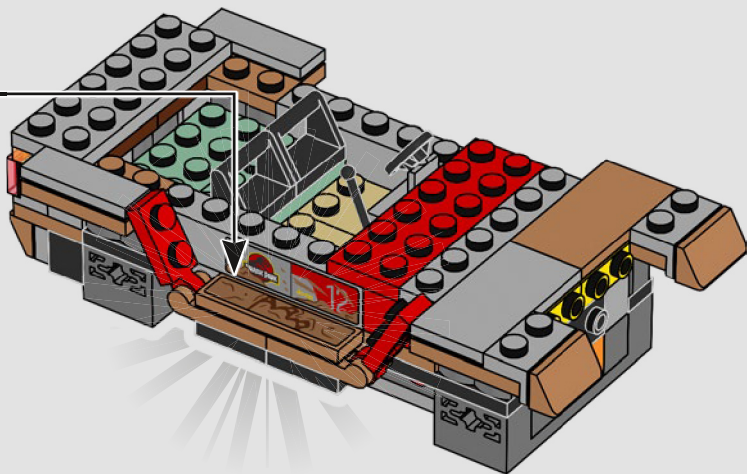
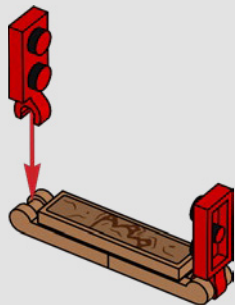

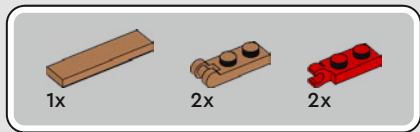

48

1

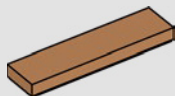

2

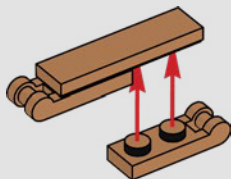

3

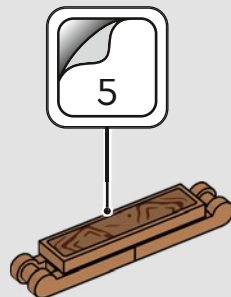

4

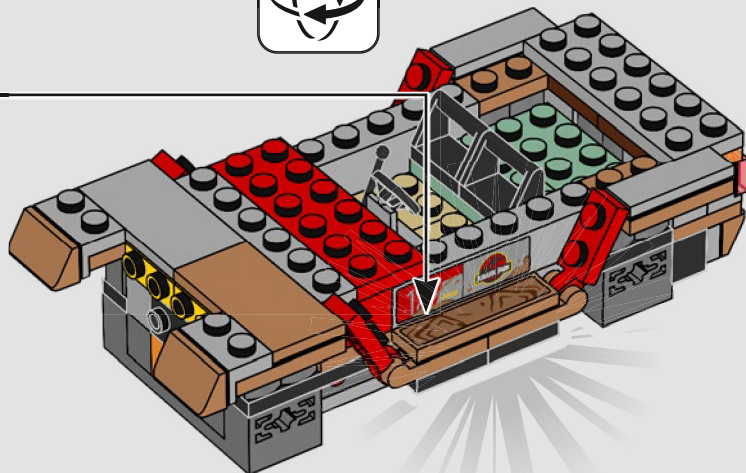
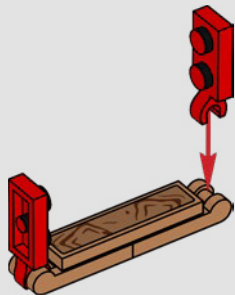



2x

49

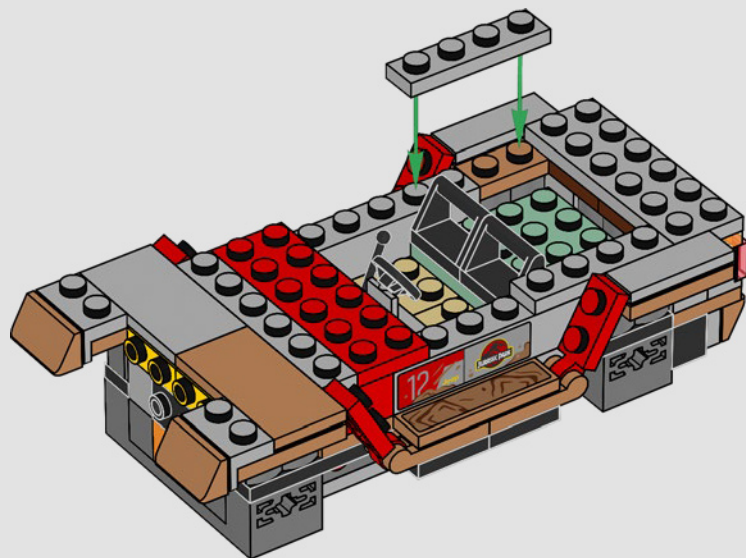



2x



2x

50

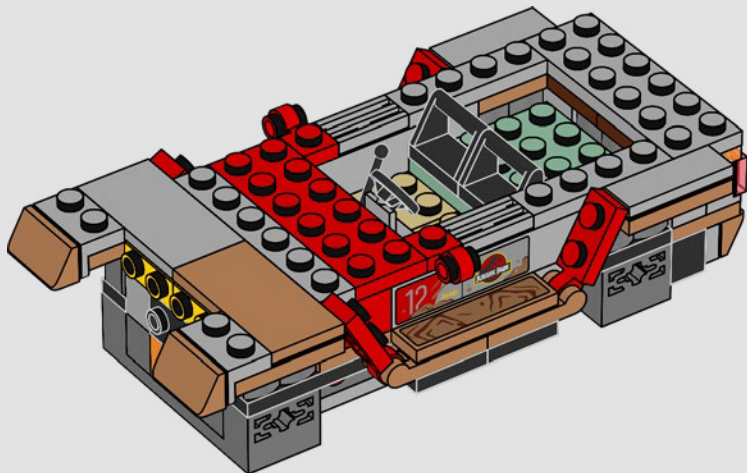

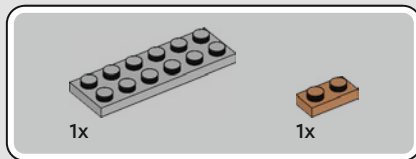
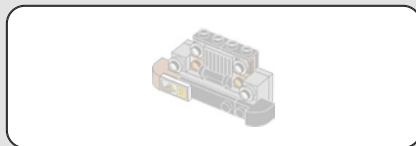

51

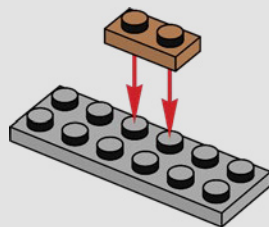



1x

52

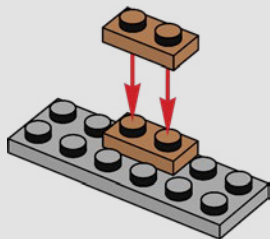

1x

53

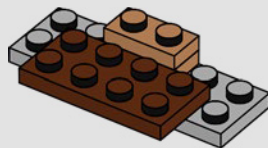



2x

54

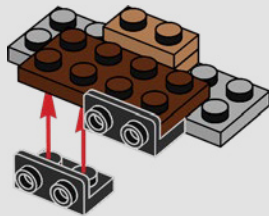



1x

55

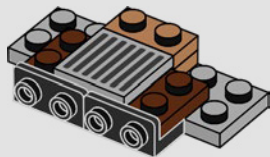

2x



2x

56

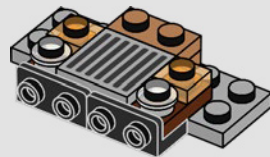



2x



1x

57

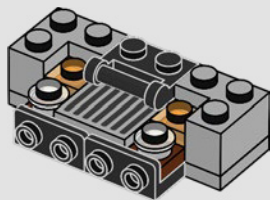

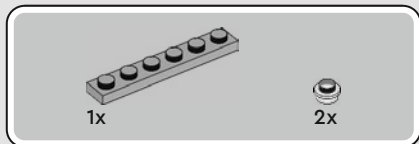

58

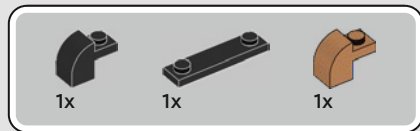
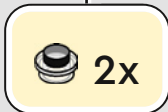
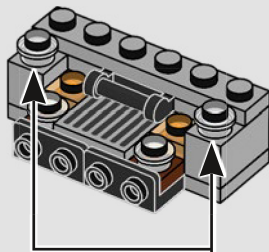

59

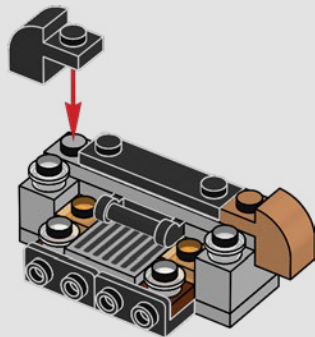



1x

60

1



2

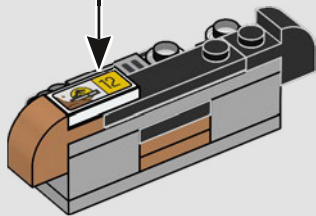

61

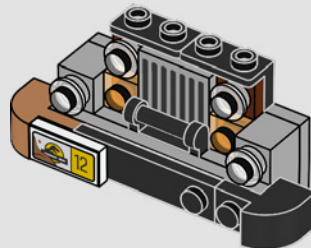

62

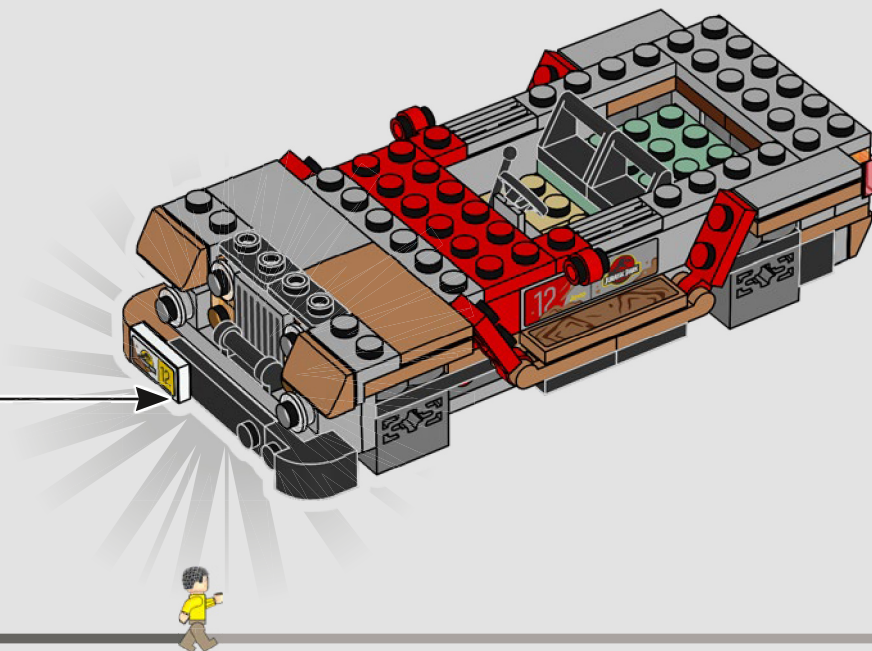

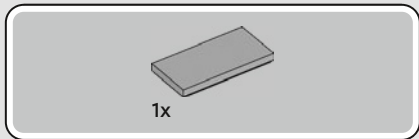

63

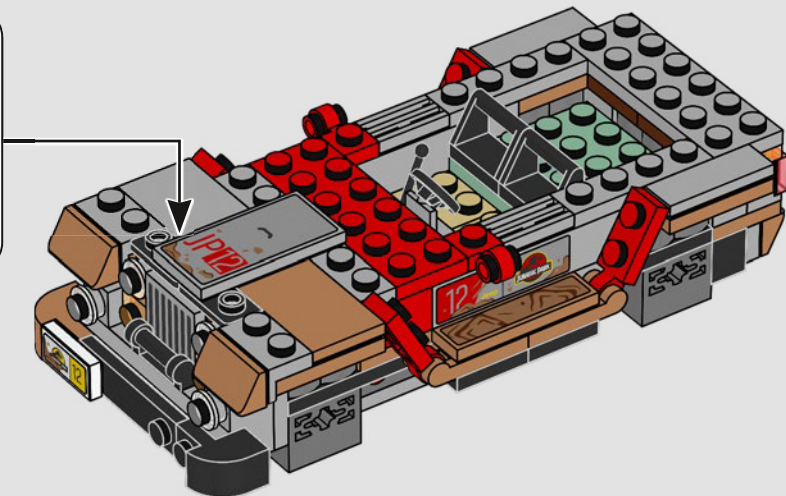
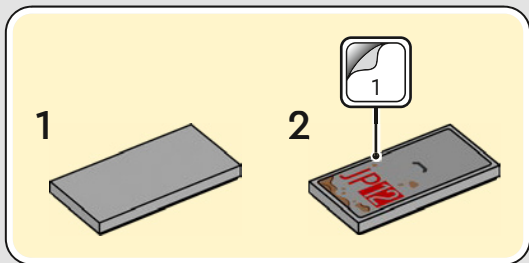

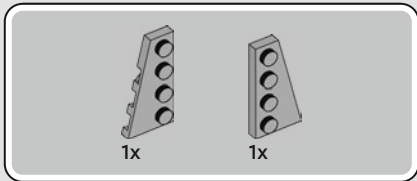

64

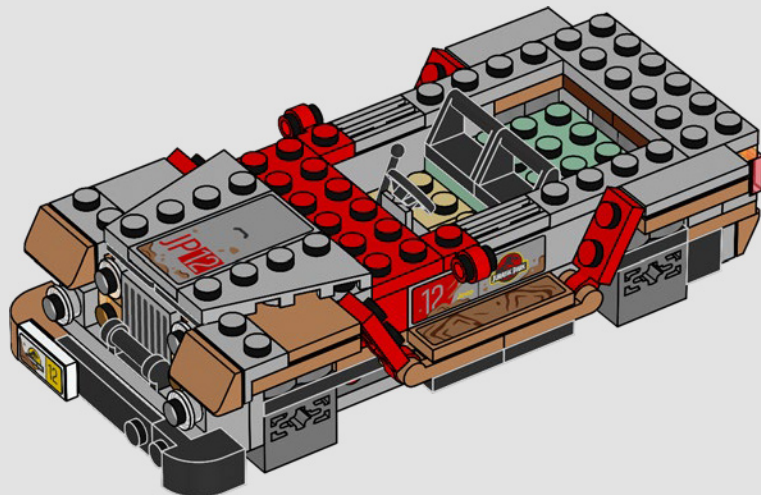



2x

65



2x

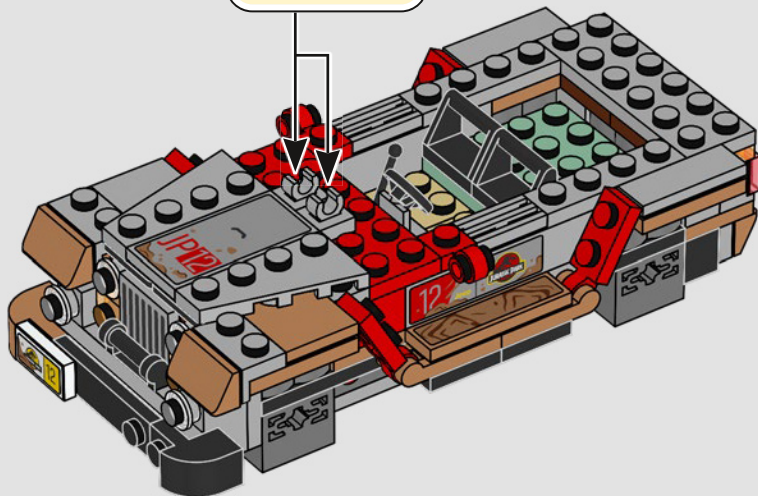

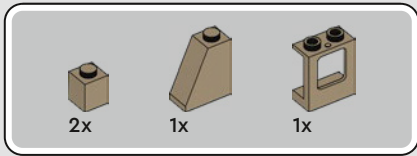

66

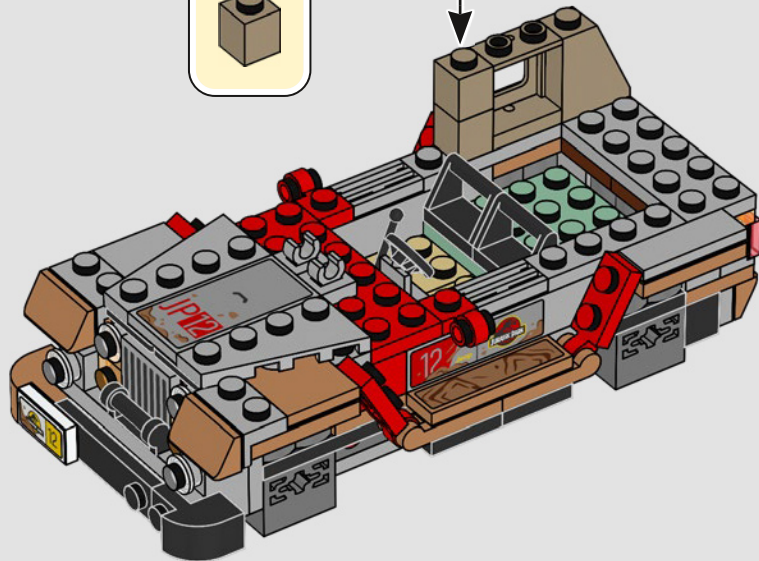
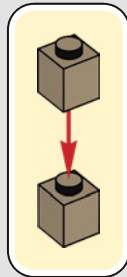

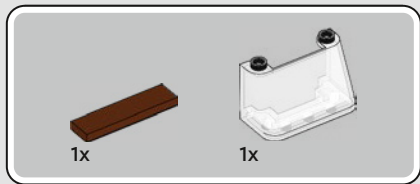

67

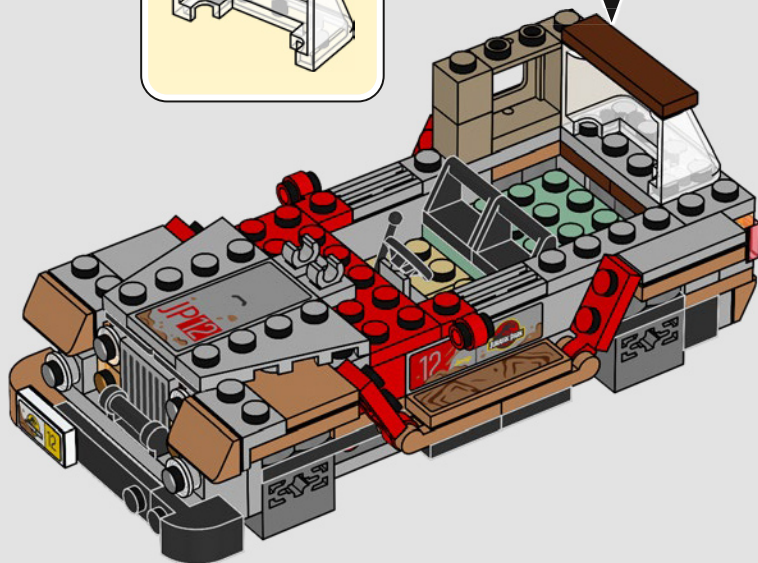
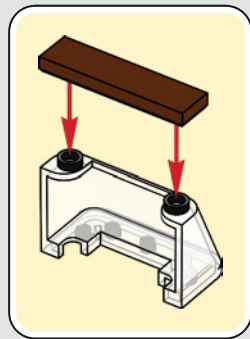

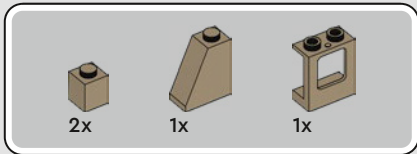

68

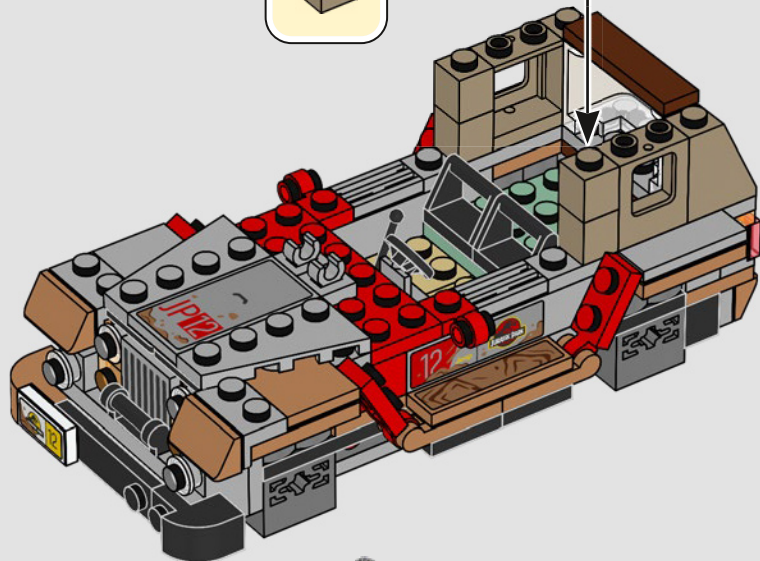
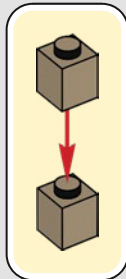



2x

69

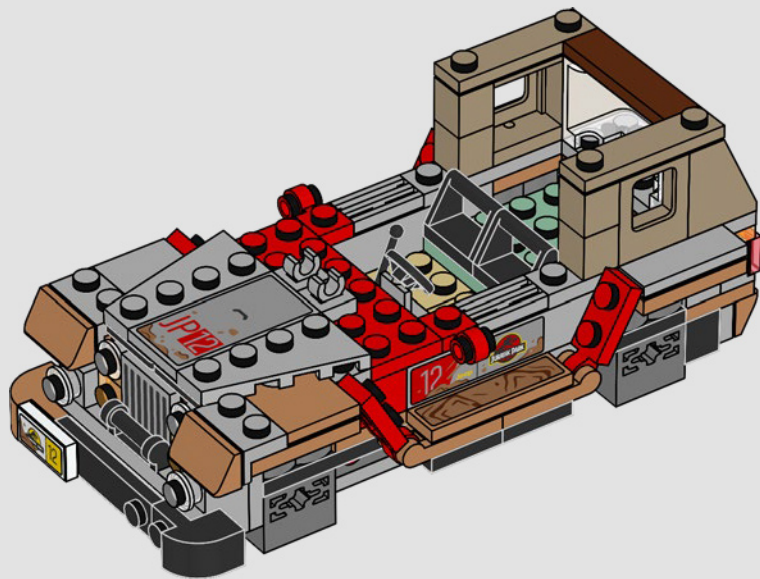

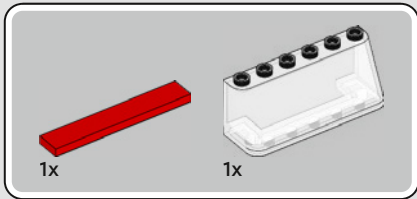

70

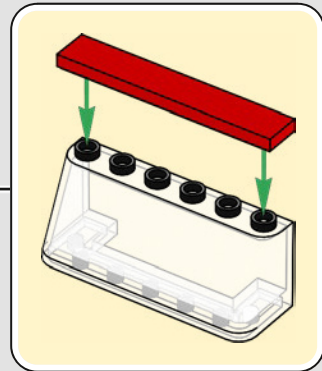
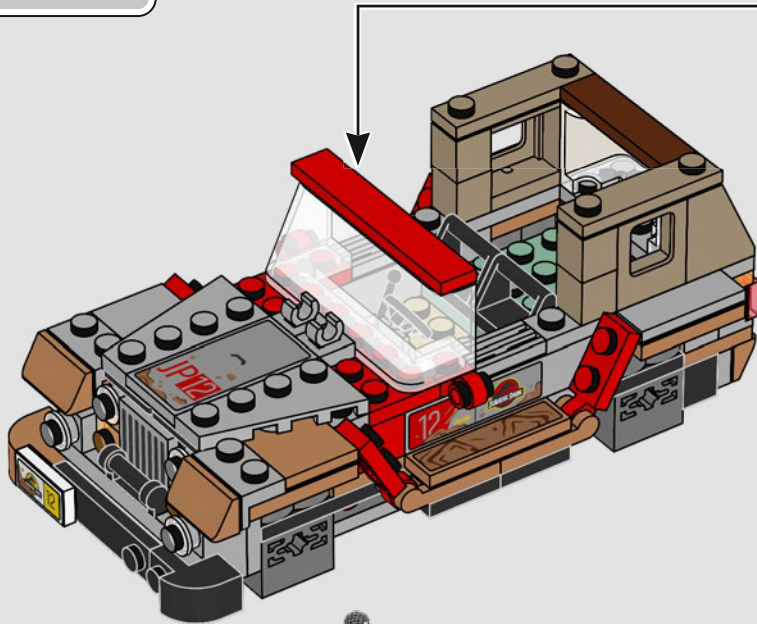

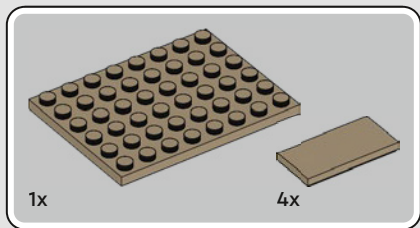

71

1

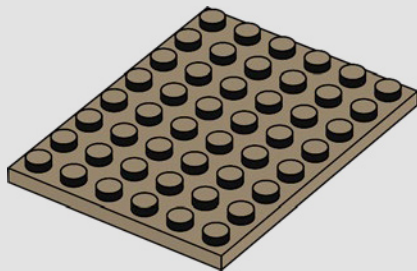

2

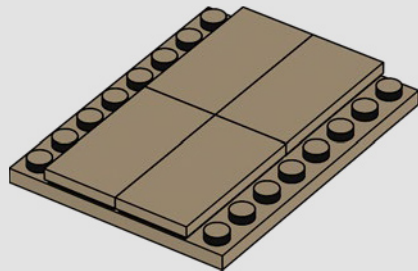

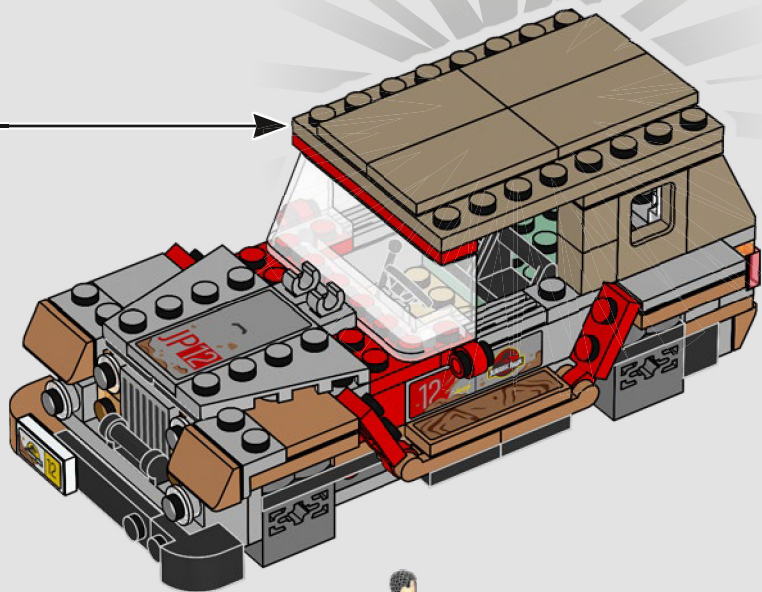

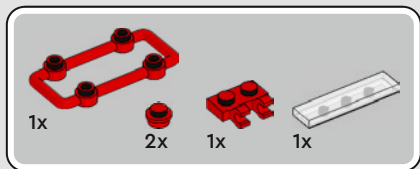

72

1

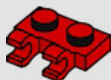

2

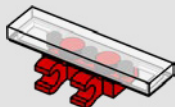

3

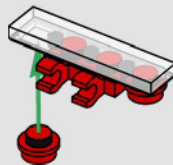

4

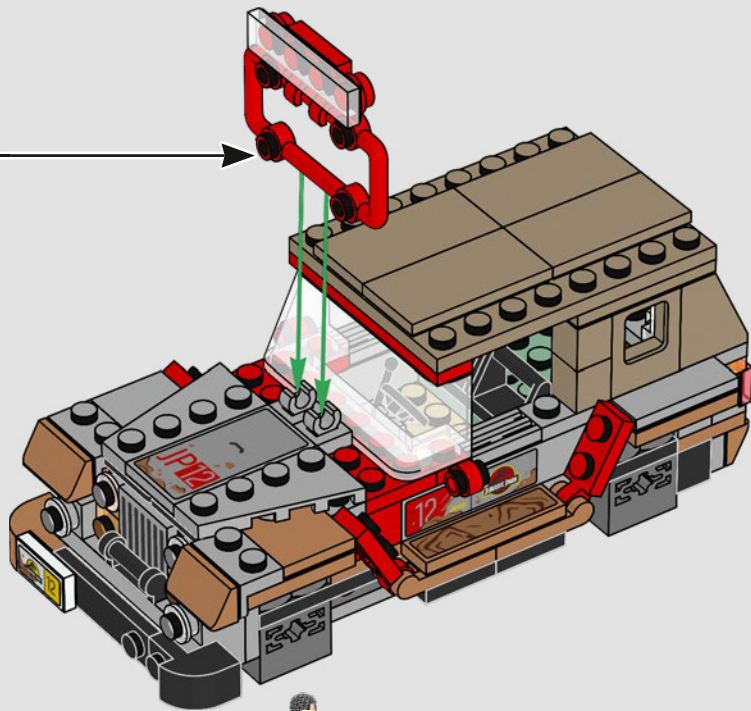
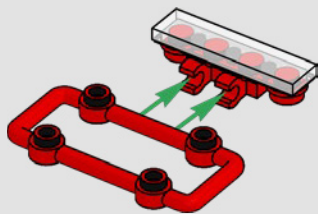

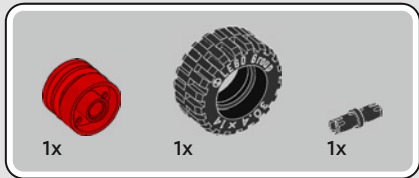

73

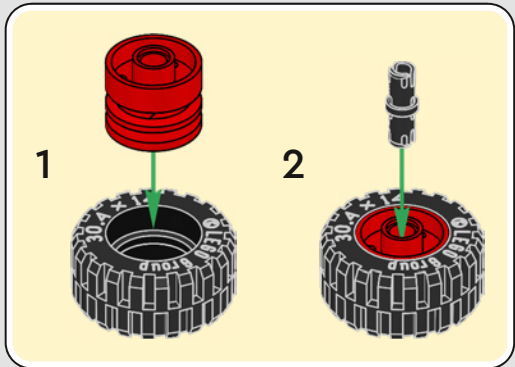
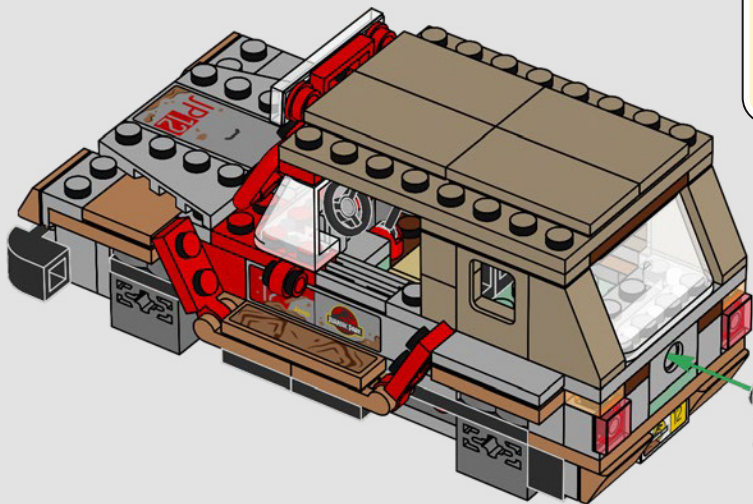



74

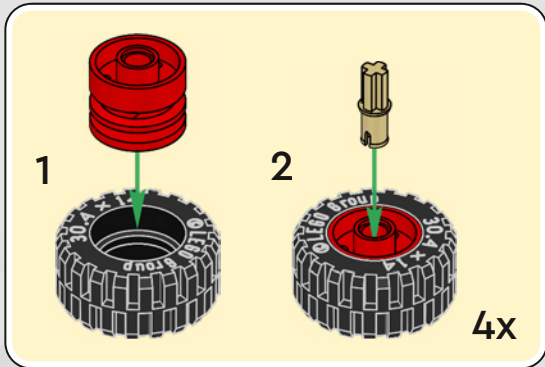
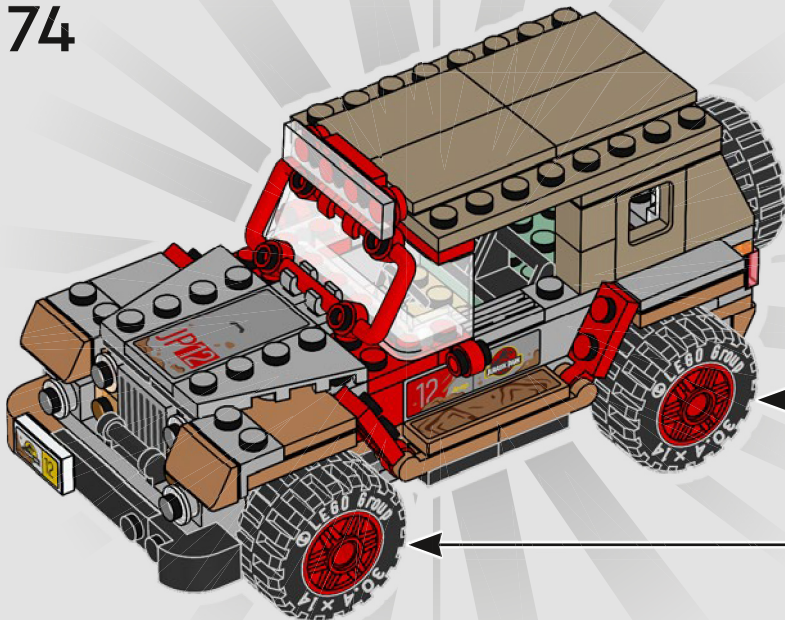

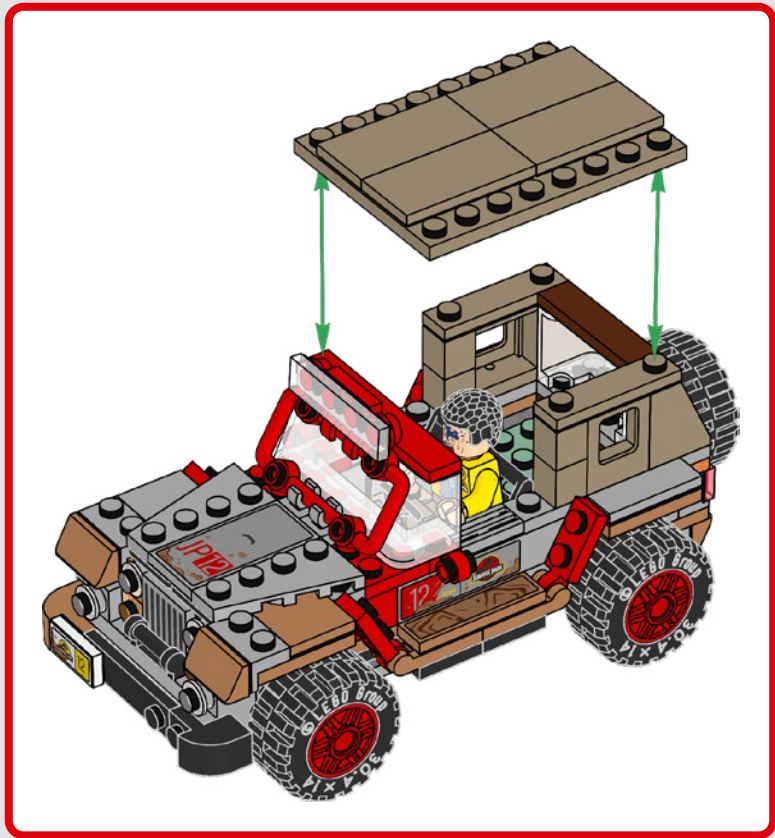

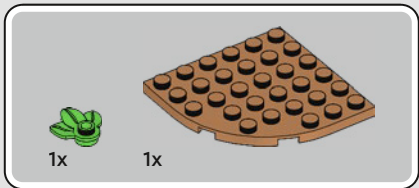

1

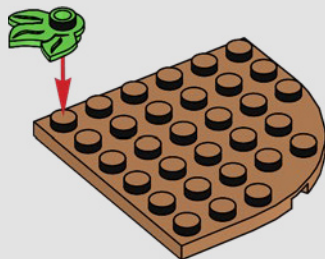



1x



1x

2

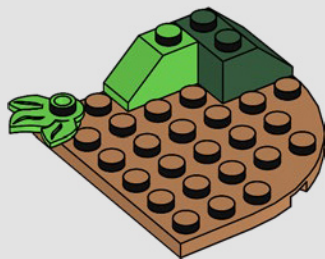

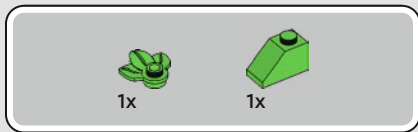

3

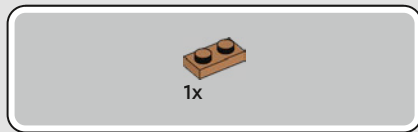
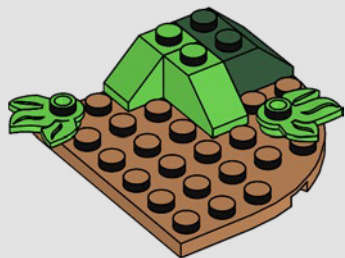

4

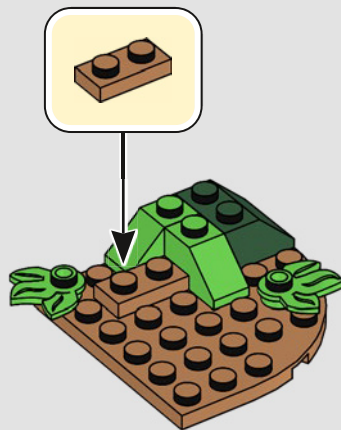



1x



2x

5

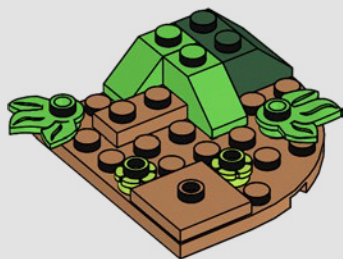



1x



1x

6

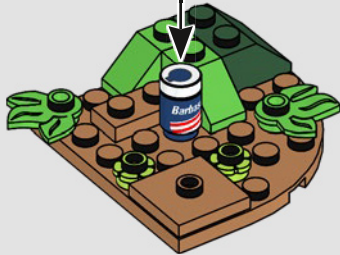

1x



1x

7

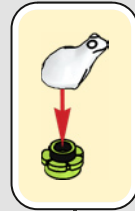



1x

8



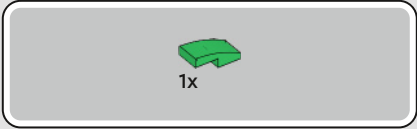

9

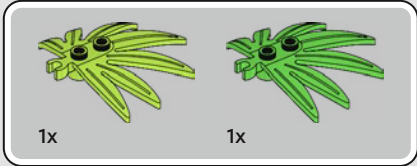

10



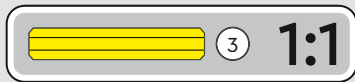
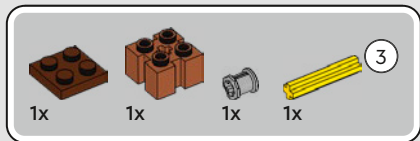

11

1



2

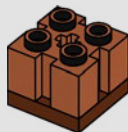

3

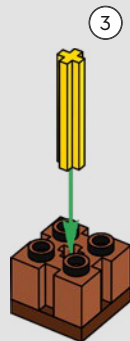

4

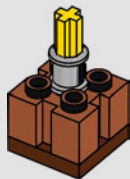

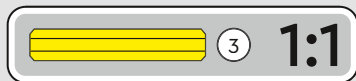
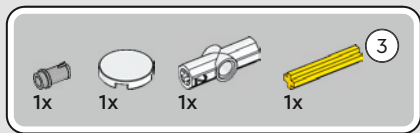

12

1



2

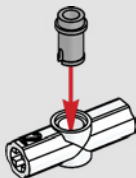

3

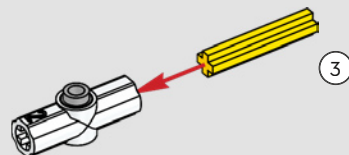

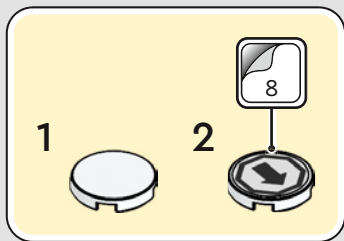

4





2x

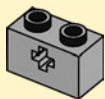

2x

13



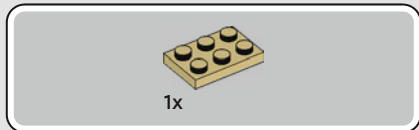

14

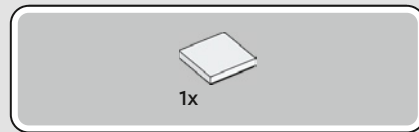

15

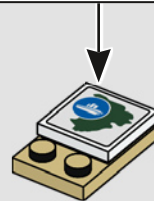
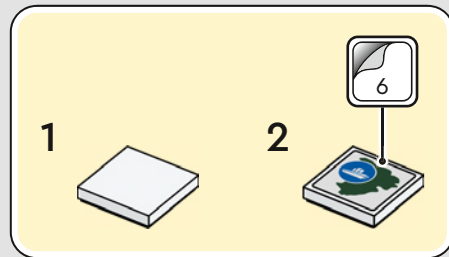

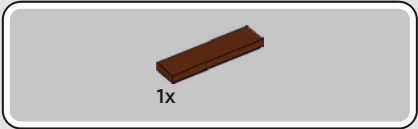

16

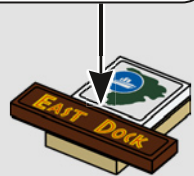
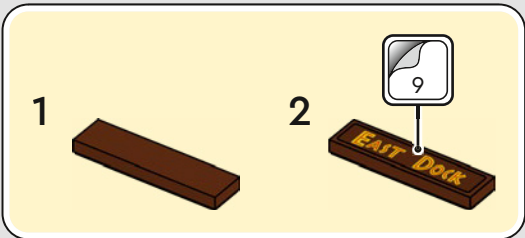

17

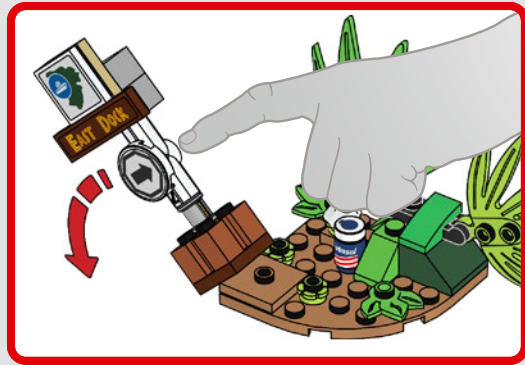





76961







4x
6001824



1x
4524098



2x
6442915



2x
6354068



2x
6257599



4x
6164288



1x
4251796



1x
6443351



1x
6298930



1x
6044691



2x
306901



1x
306801



1x
6271870



4x
6240030



1x
6289455



1x
6253681



1x
6245195



1x
6245195



1x
74335



2x
614121



4x
6378120



2x
6281994



2x
300421



1x
6360036



4x
6346804



5x
6256881



1x
6439693



1x
4113858



1x
379521



2x
6254248



4x
6218358



3x
6218360



1x
6360296



1x
6102994



4x
6167699



6x
6334099



2x
6102998



2x
6167700



1x
6218359



1x
6313600



1x
6346466



1x
6315198



1x
4153825



4x
6252040



4x
4666579



2x
6221467



1x
4118790



1x
6047426



2x
6182261



2x
6300148



1x
6347460



3x
6209692



1x
6313098



1x
6223304



2x
4655080



4x
6075626



3

2x
6130007



2x
6248833



1x
6441115



1x
4243817



2x
4211257



1x
4216695



2x
4211194



2x
4211186



1x
6275844



1x
4211483



2x
4211476



2x
6308012



1x
4211735



1x
4211732



1x
4211440



2x
6206249



2x
4654582



6x
4211349



2x
4558169



6x
4211445



2x
4560183



3x
4211438



2x
4211393



2x
4211452

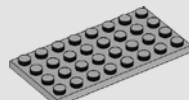

1x
4211407



3x
4211350



1x
6444487



1x
4226995



2x
6020193



1x
4225201



4x
6061032



1x
6099483



1x
6254045



3x
6138173



2x
243226



1x
6122096



5x
6279875



1x
6184784



5x
4619323



2x
4514845



2x
4210963



2x
6454959



7x
4211095



1x
6436296



1x
6436346



1x
6302448



1x
6436298

 [LEGO.com/service](https://www.LEGO.com/service)



YOU COULD
WIN



Scan this QR code or go to
LEGO.COM/PRODUCTFEEDBACK and give
us your short feedback about this LEGO® set
for a chance to win a cool LEGO prize.

Terms and Conditions apply*

EN: YOU COULD WIN. Terms and Conditions apply* **DE: Du könntest GEWINNEN.** Es gelten die Teilnahmebedingungen* **FR: Tu pourrais GAGNER.** Des conditions s'appliquent* **IT: Potresti VINCERE tu.** Termini e condizioni sono applicabili* **ES: Puedes GANAR.** Aplican términos y condiciones* **PT: Poderá GANHAR.** Aplicam-se termos e condições* **ZH: 轻松获奖. 条款和条件适用*** **PL: Szansa na WYGRANĄ.** Obowiązują warunki korzystania* **CS: Máte šanci VYHRÁT.** Platí všeobecné smluvní podmínky* **SK: Máte šancu VYHRAŤ.** Platia všeobecné zmluvné podmienky* **HU: TE IS NYERHETSZ.** Felhasználási feltételek érvényesek* **RO: Ai putea CÂȘTIGA.** Se aplică termeni și condiții* **BG: Можете да СПЕЧЕЛИТЕ.** Има определени правила и условия* **LV: Tu vari LAIMĒT.** Ir spēkā noteikumi un nosacījumi.* **ET: Sul on võimalus VÕITA.** Kehtivad tingimused* **LT: Jūs galite LAIMĖTI.** Taikomos sąlygos*

*[LEGO.com/productfeedback-terms](https://www.lego.com/productfeedback-terms)

LEGO and the LEGO logo and are trademarks of the LEGO Group. ©2023 The LEGO Group. 6464477

© Universal City Studios LLC and Amblin Entertainment, Inc. All Rights Reserved.

Jeep, the Jeep grille and related logos, vehicle model names and trade dress are trademarks of FCA US LLC and used under license by the LEGO Group. ©2023 FCA US LLC.