



CITY

60380



1



LEGO.com/sustainable-packaging

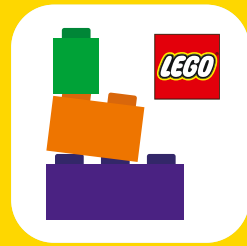

BUILDER



Apple and the Apple logo are trademarks of Apple Inc., registered in the U.S. and other countries and regions. App Store is a service mark of Apple Inc. Google Play and the Google Play logo are trademarks of Google LLC. Tencent and the Tencent logo are trademarks of Tencent Inc.

Q [LEGO.com/devicecheck](https://www.lego.com/devicecheck)

EN Ask parents' permission before going online | DE Eltern um Erlaubnis bitten, bevor du online gehst | FR Demande l'autorisation d'un parent avant d'aller en ligne | IT Chiedi il permesso ai tuoi genitori prima di andare online | ES Pídeles permiso a tus papás antes de conectarte a Internet | PT Peça autorização aos pais antes de acederes online | ZH 上网前应先征得父母的同意 | PL Poproś rodziców o zgodę, zanim wejdiesz do Internetu | CS Než půjdeš na internet, požádej rodiče o svolení | SK Skôr než pôjdeš na internet, vypýtaj si povolenie od rodičov | HU Kérj szülői engedélyt, mielőtt online csatlakoznál! | RO Cere permisiunea părinților înainte de a te conecta online | BG Поискайте разрешение от родител, преди да влезете онлайн | LV Pirms došanās tiešsaistē palūdz atļauju vecākiem | ET Enne Interneti kasutamist küsi vanematelt luba | LT Prieš prisijungdami prie interneto, atsklauskite tėvų

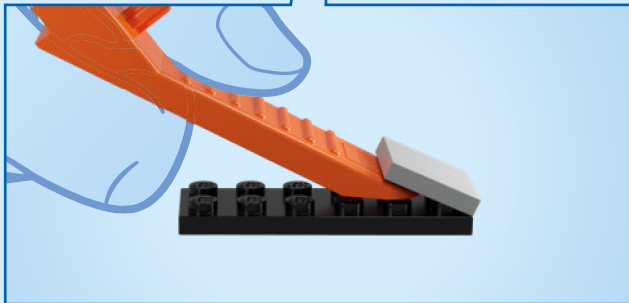
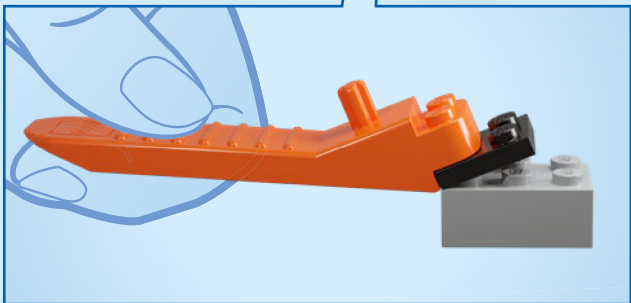
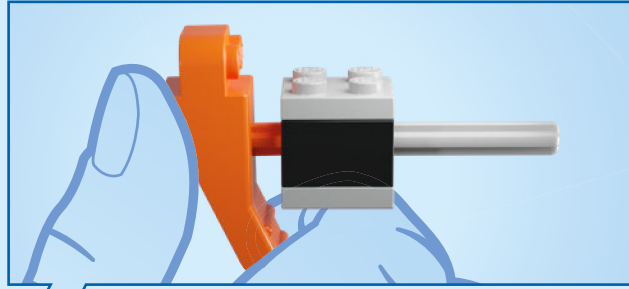
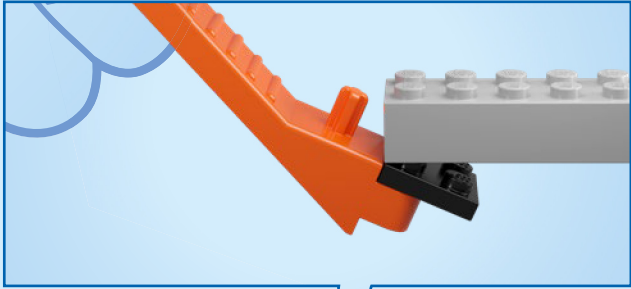

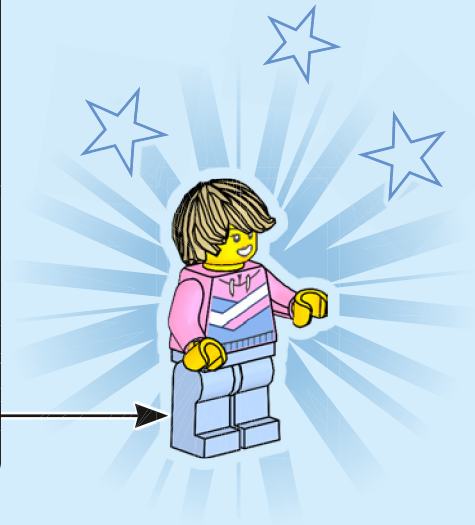
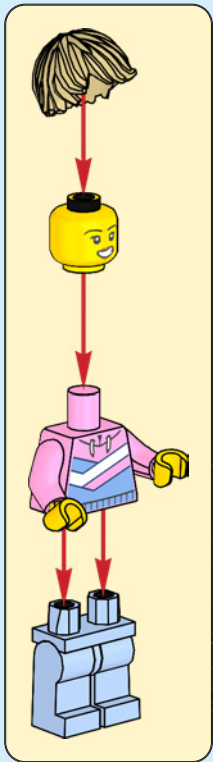
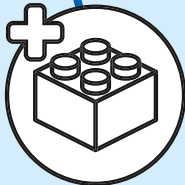
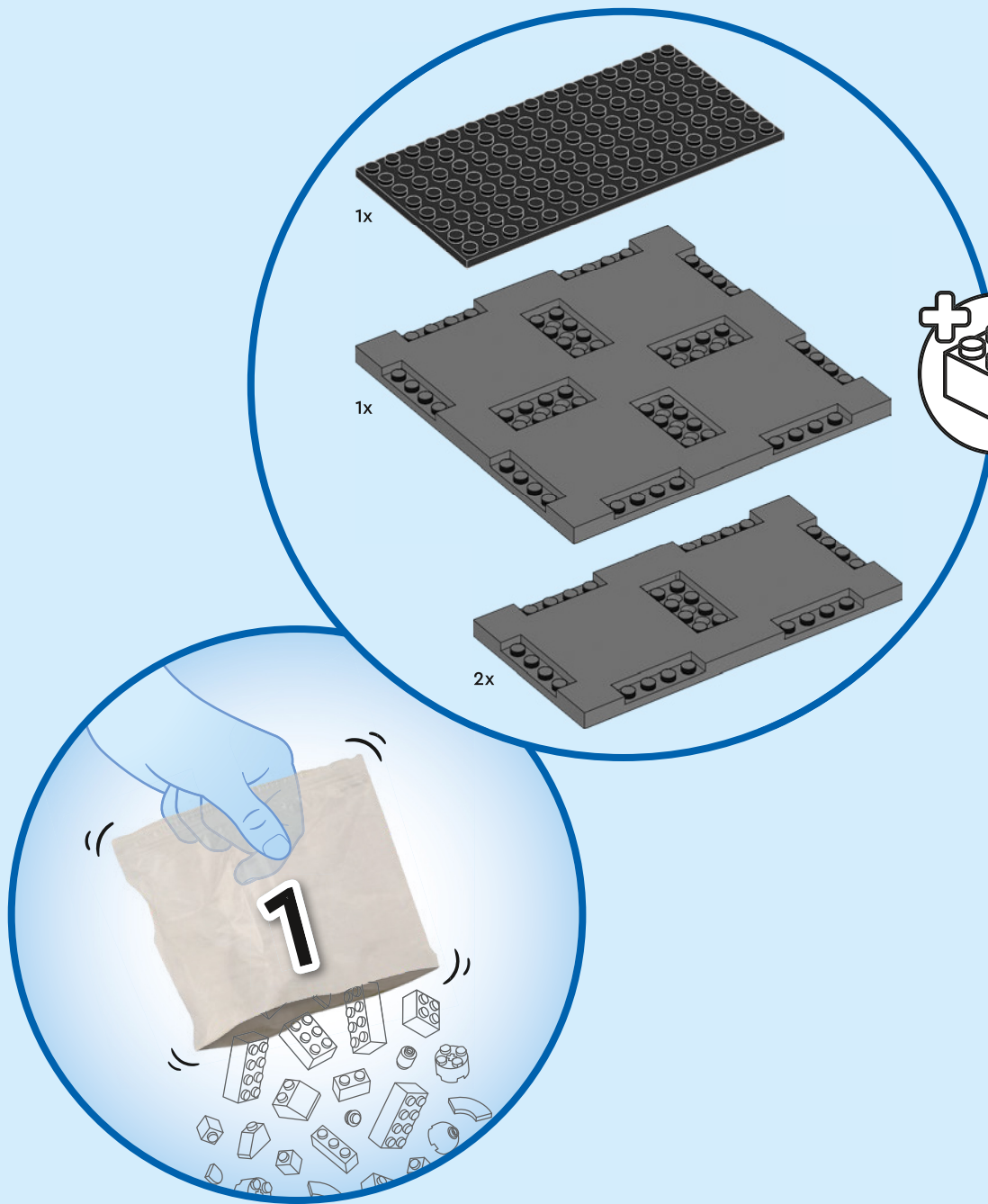

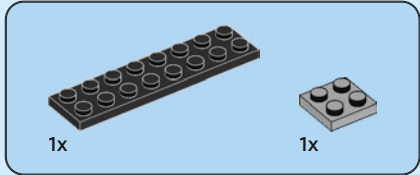

1

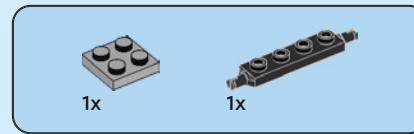
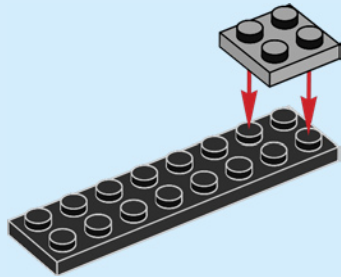

2

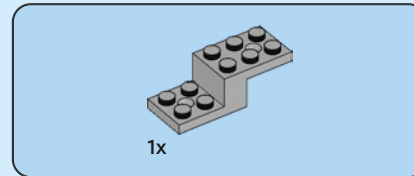
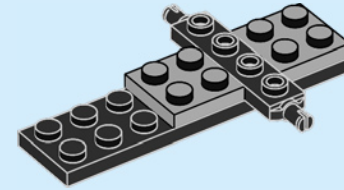

3

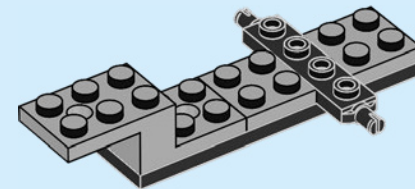

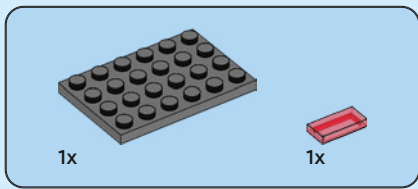

4

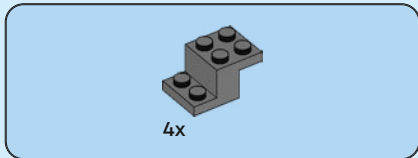
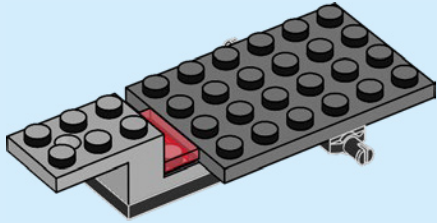

5

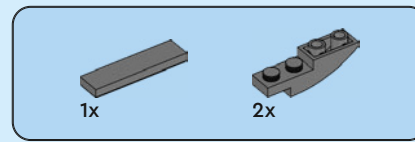
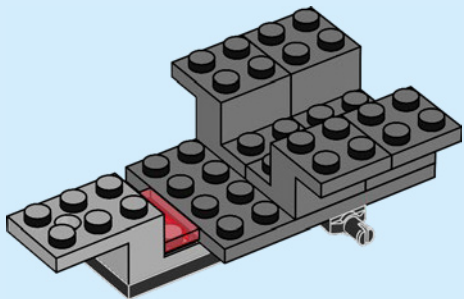

6

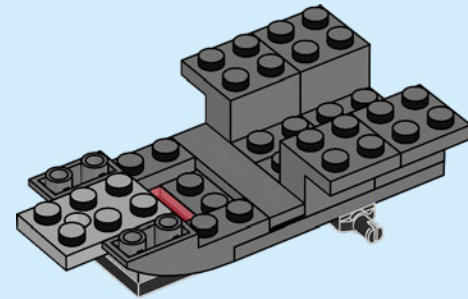

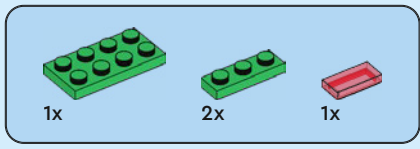

7

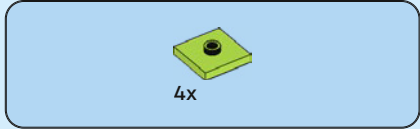
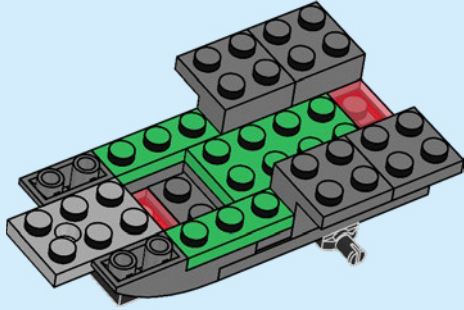

8

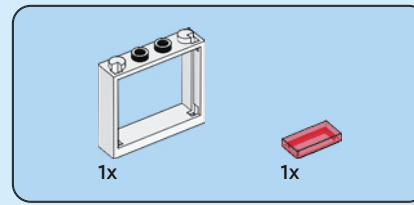
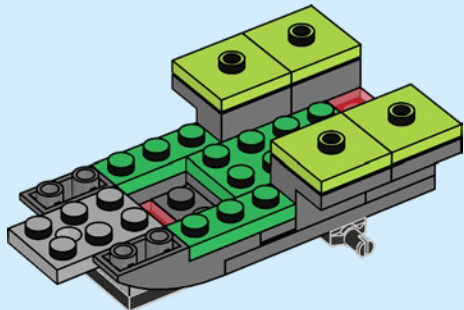

9

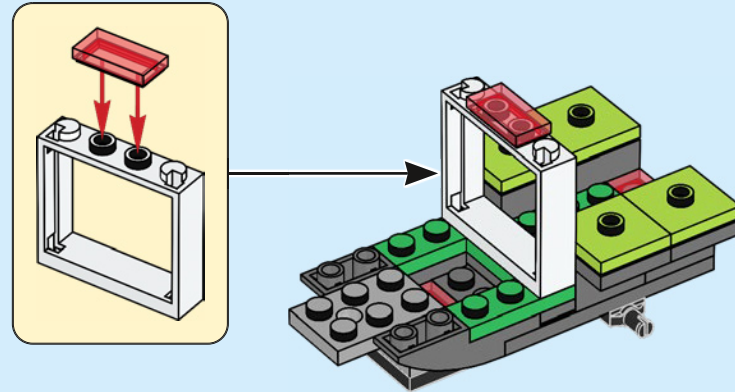

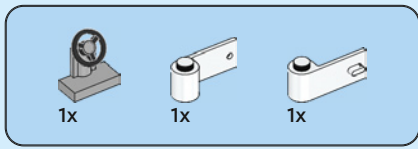

10

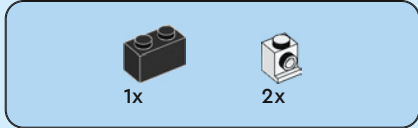
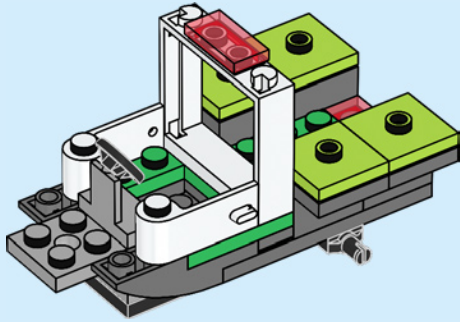

11

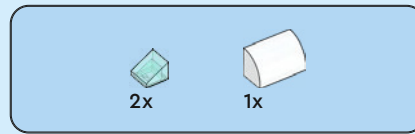
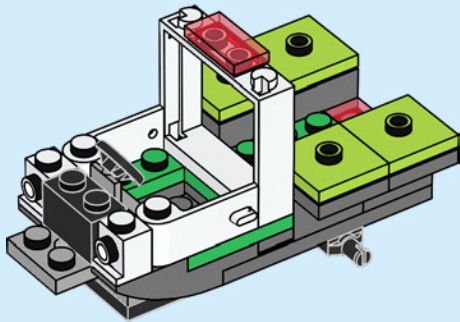

12

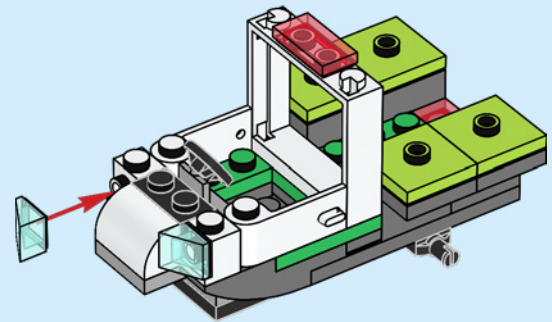

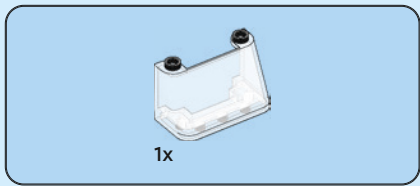

13

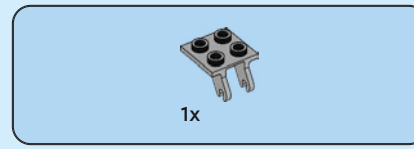
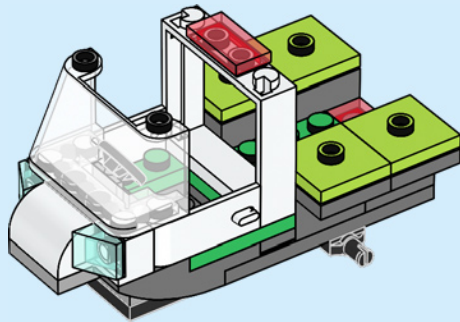

14

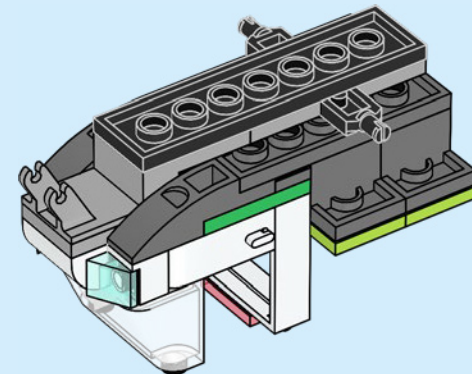
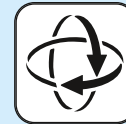

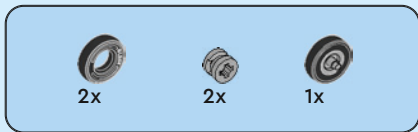

15

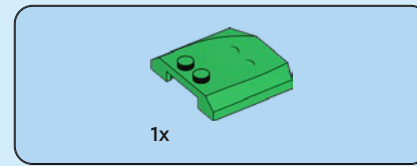
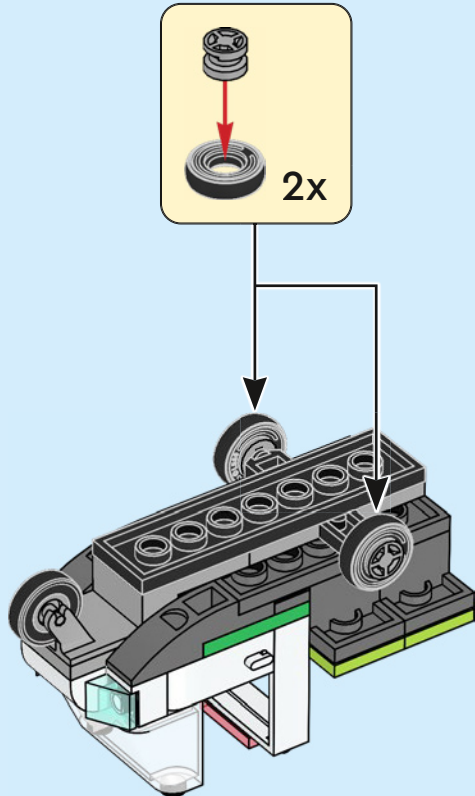

16

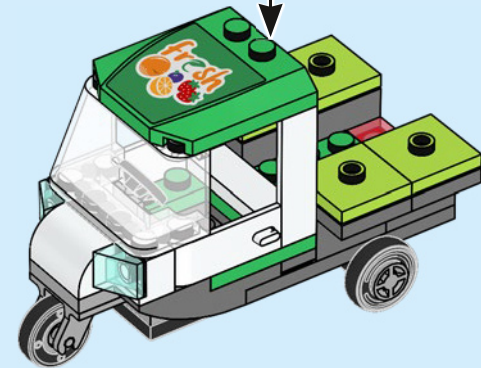
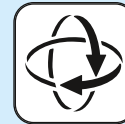
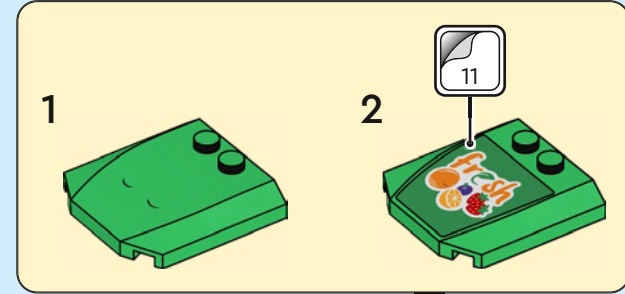

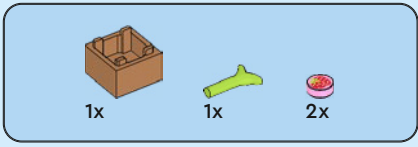

17

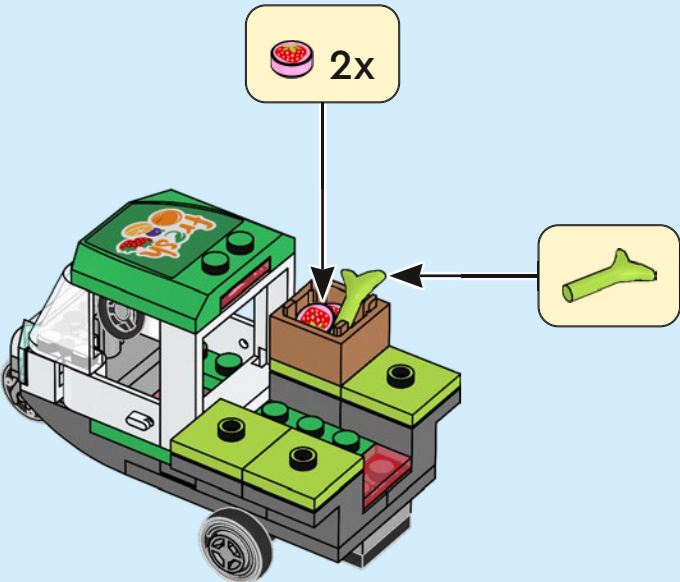

18

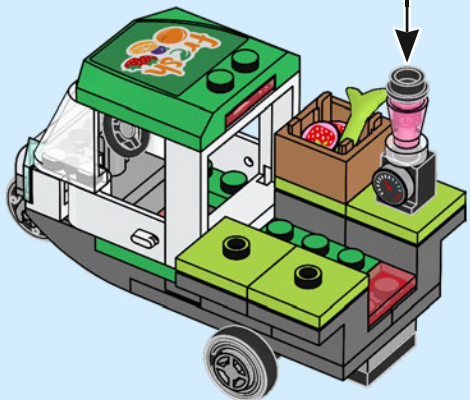
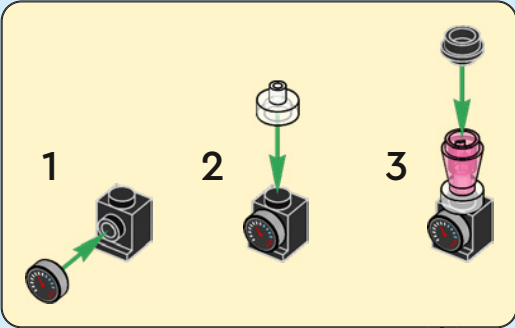

1x 1x 1x

19

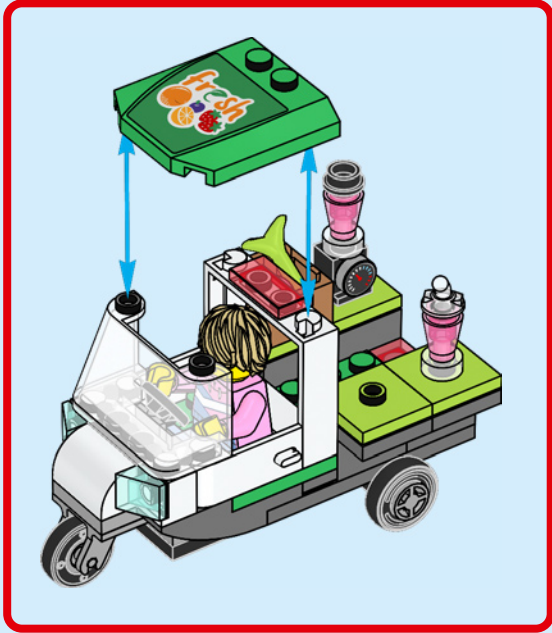
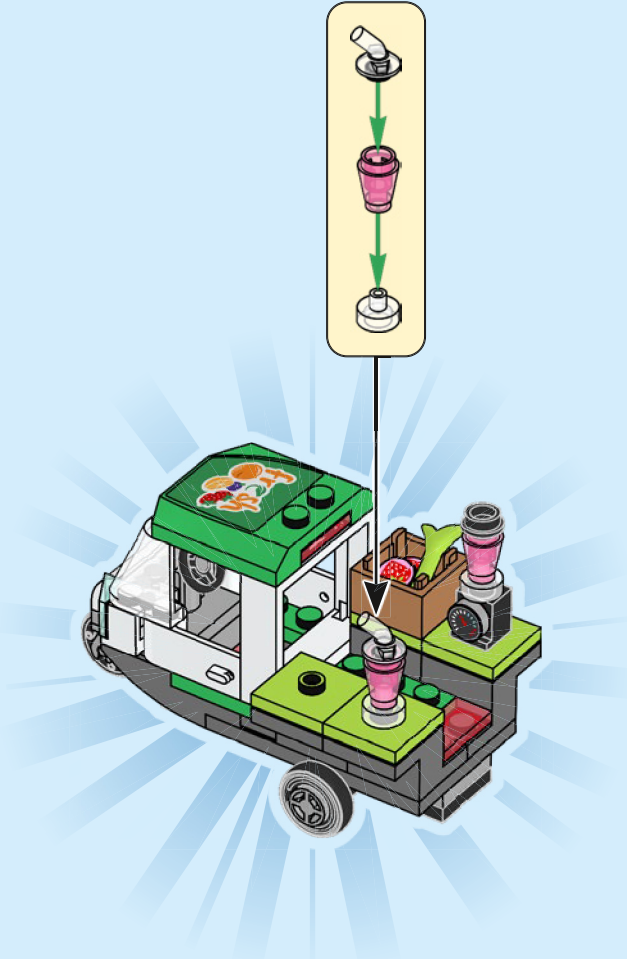

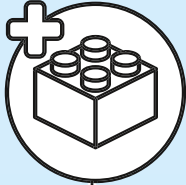
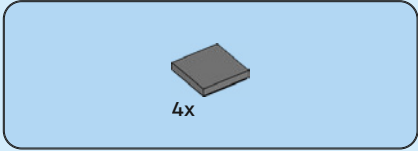

1

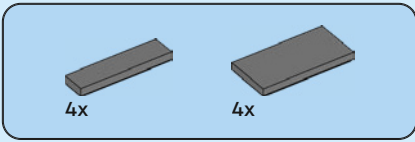
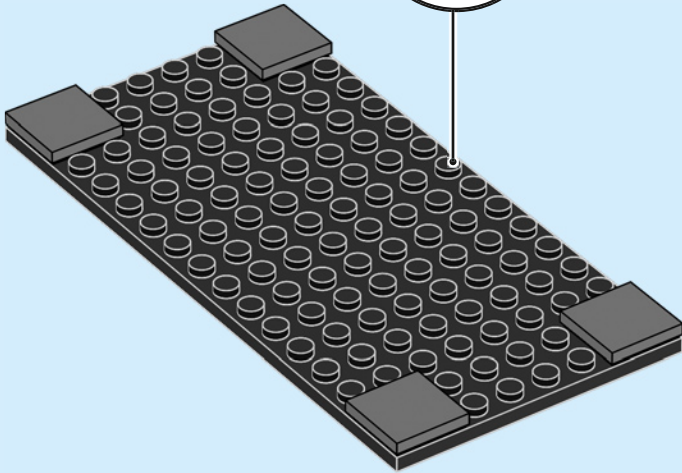

2

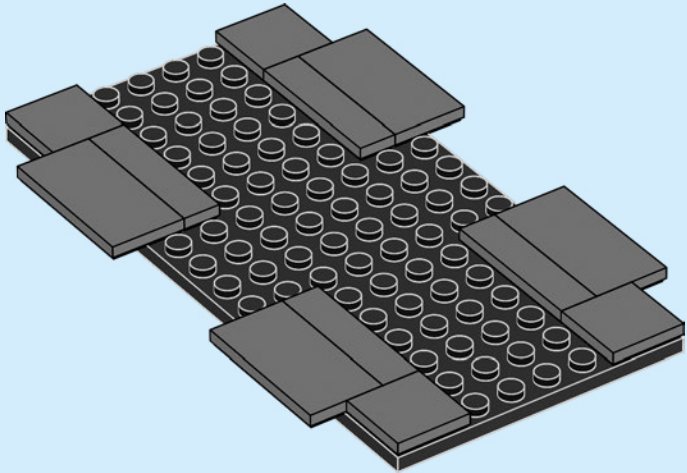

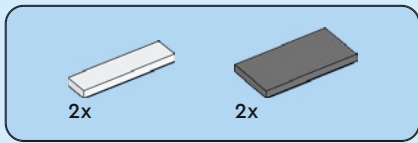

3

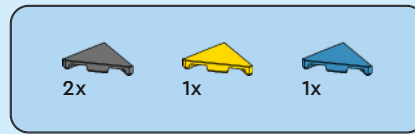
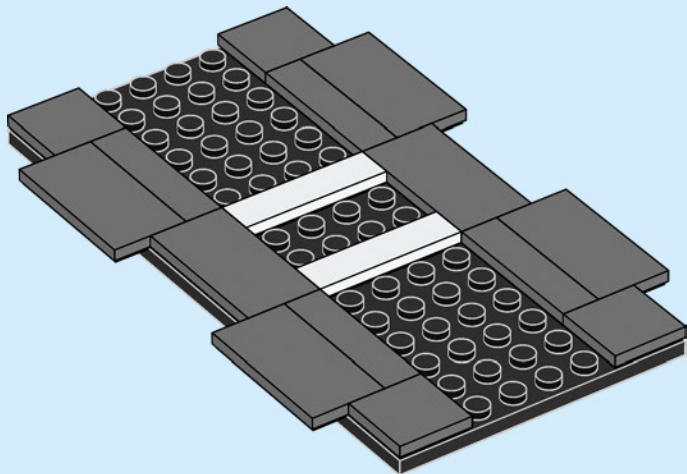

4

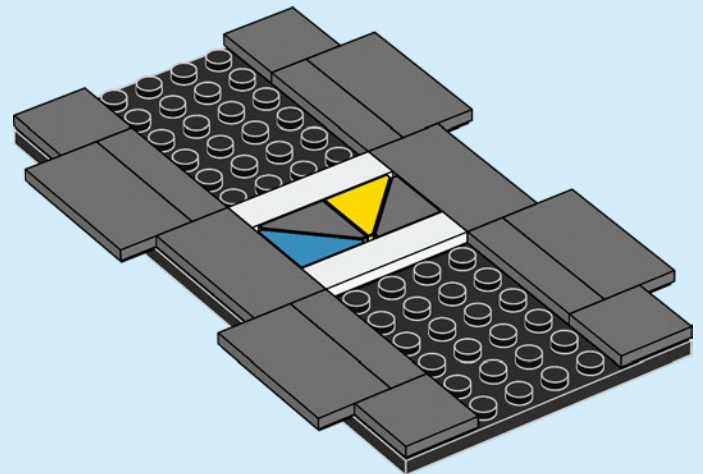

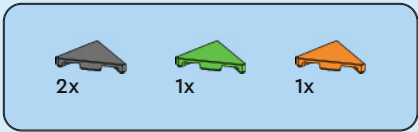

5

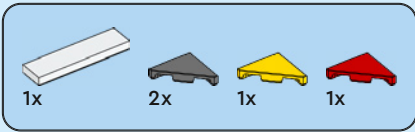
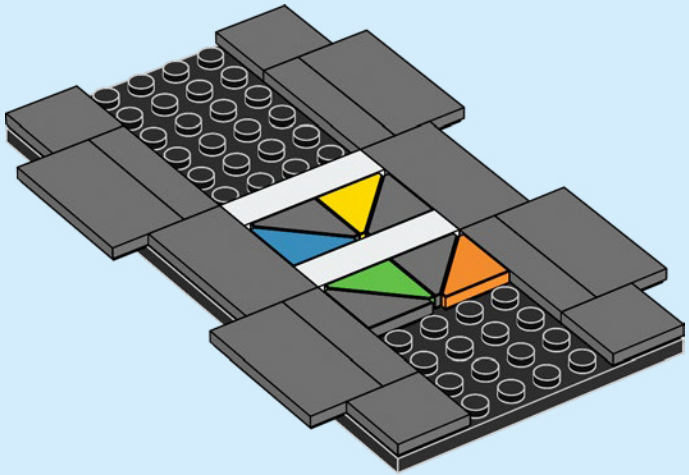

6

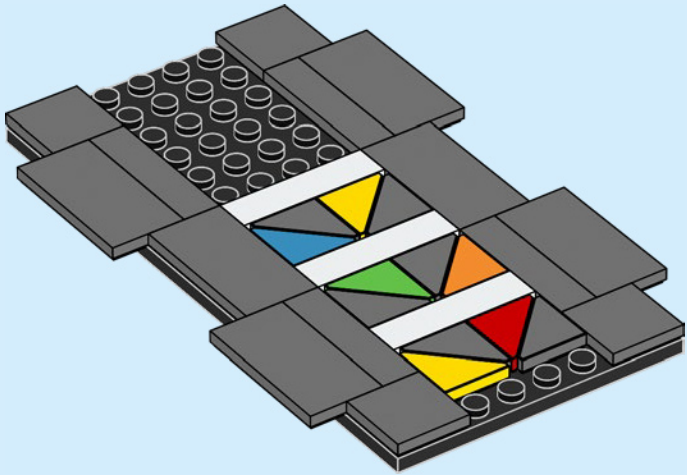



7

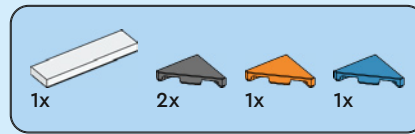
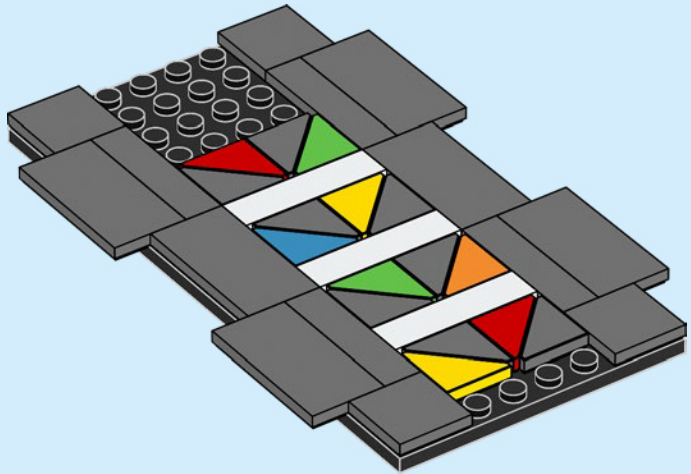

8

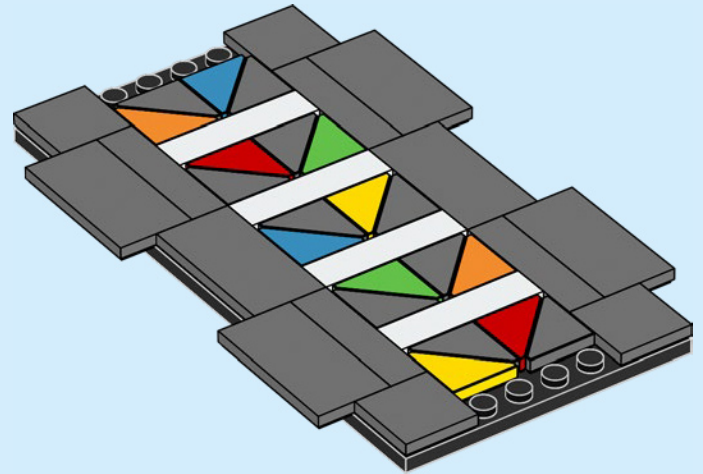

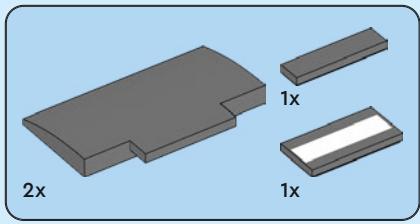

9

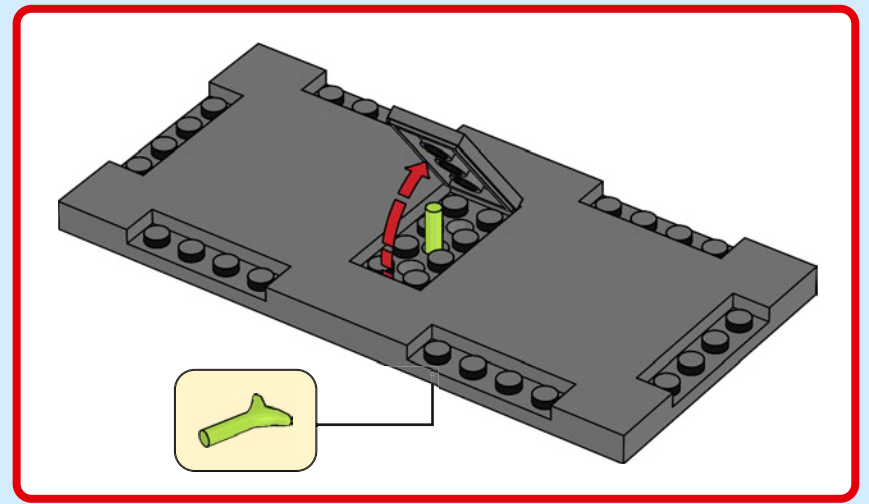
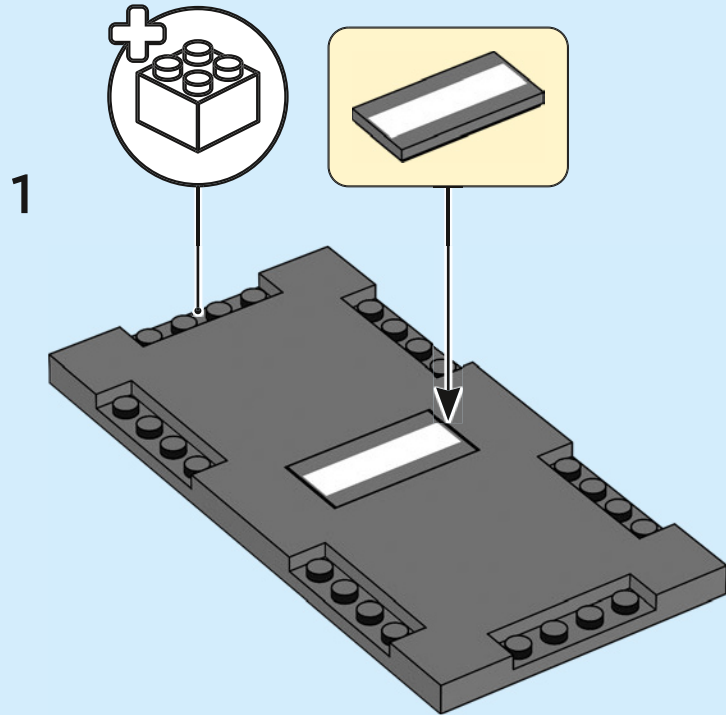

2

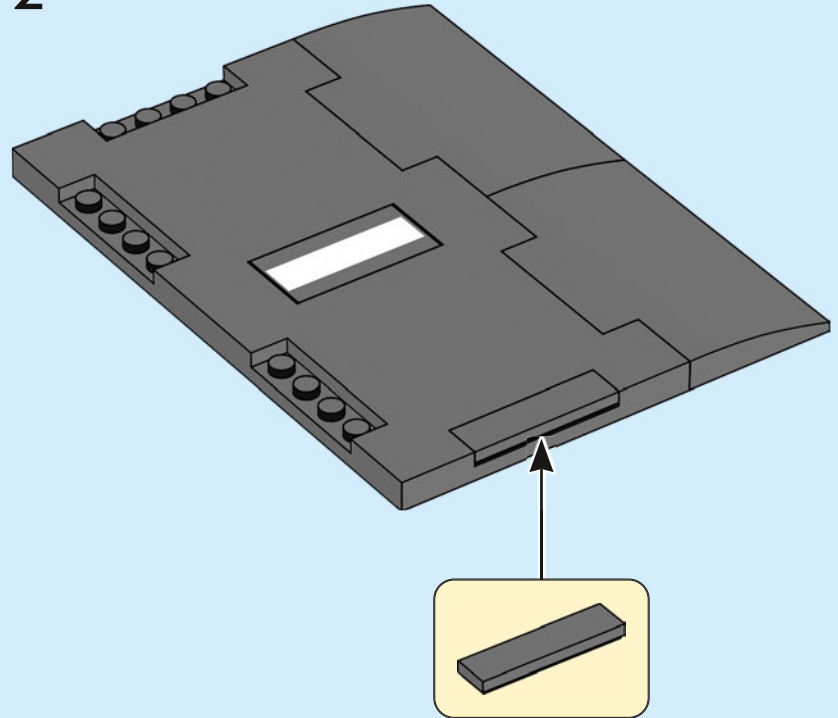

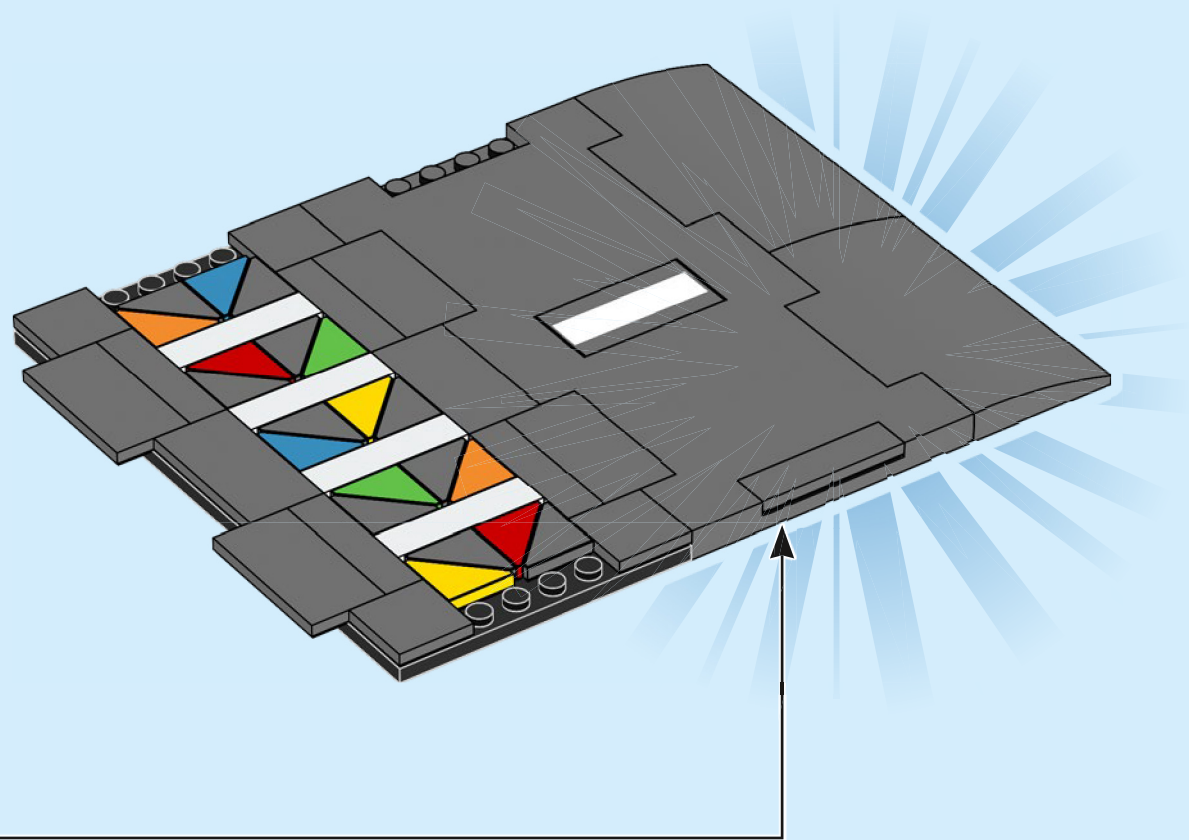

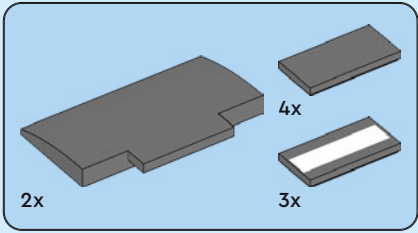
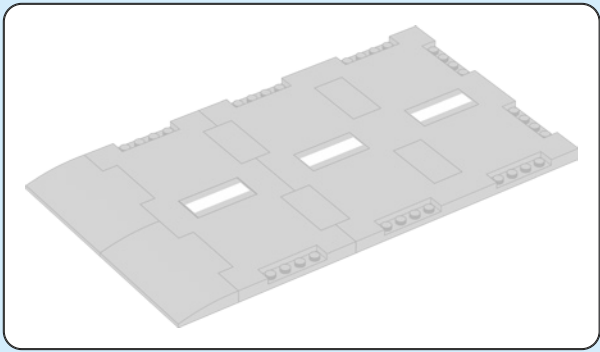

10

1

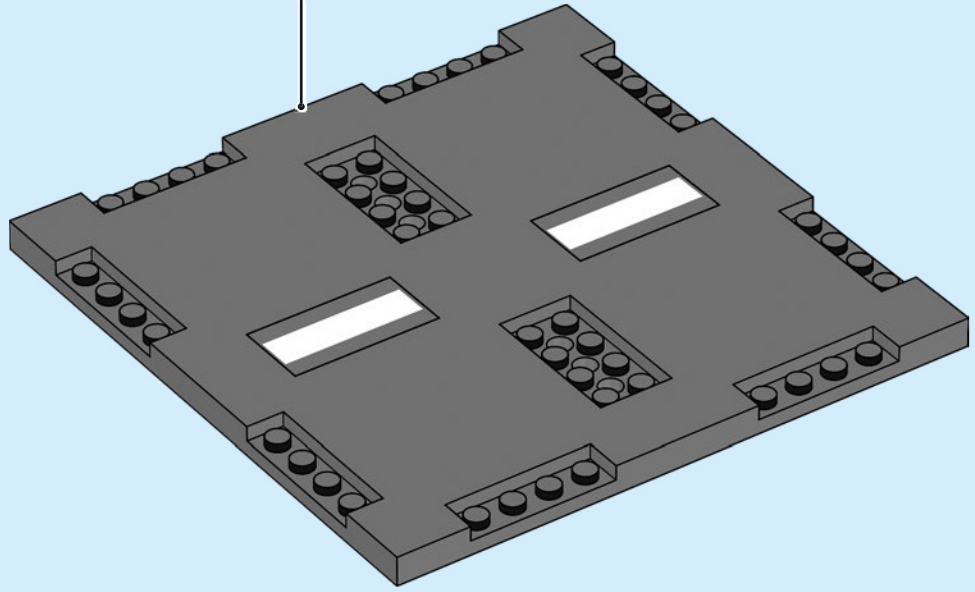
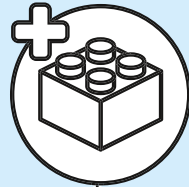

2

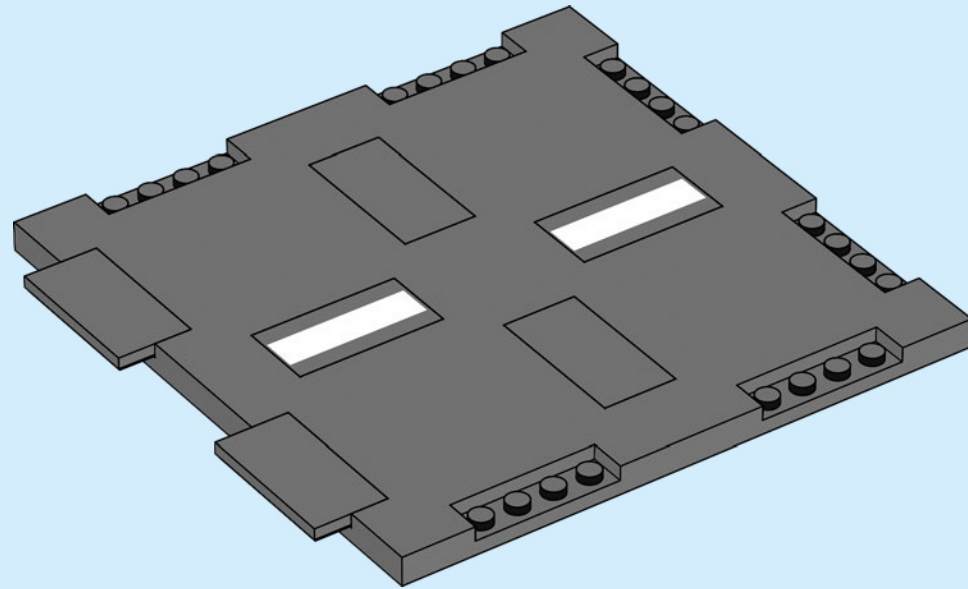

4

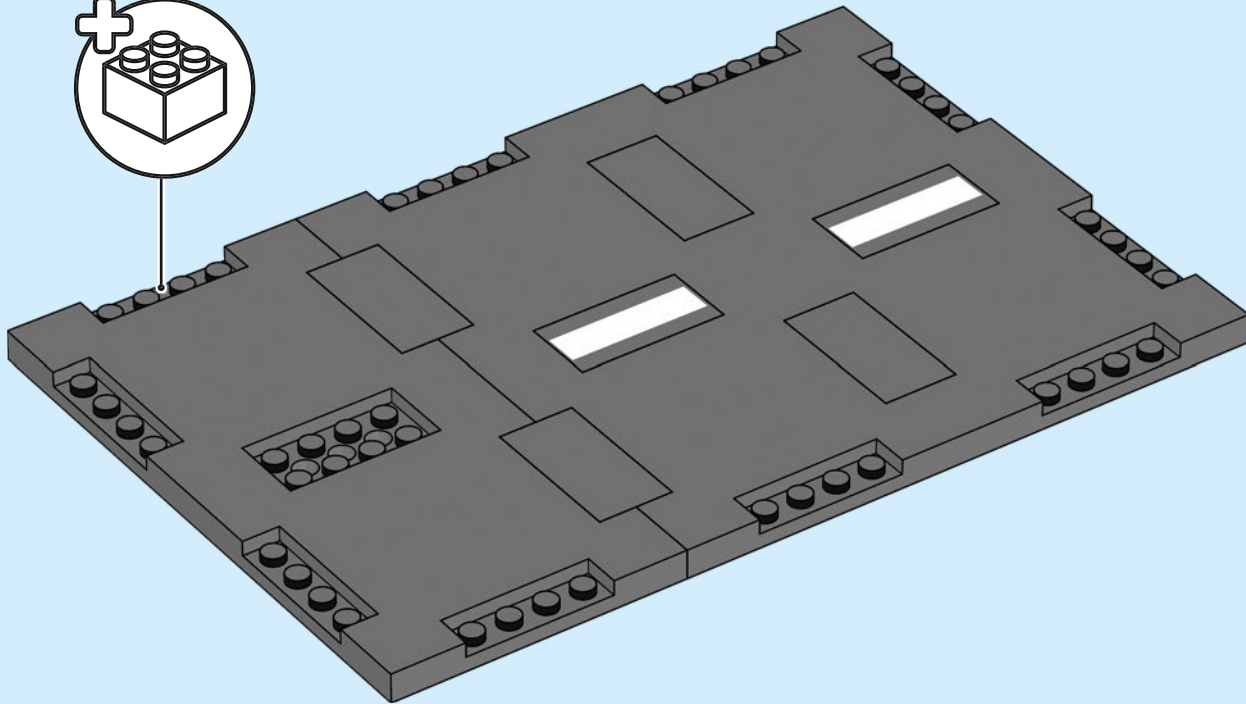
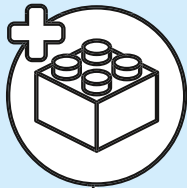

5

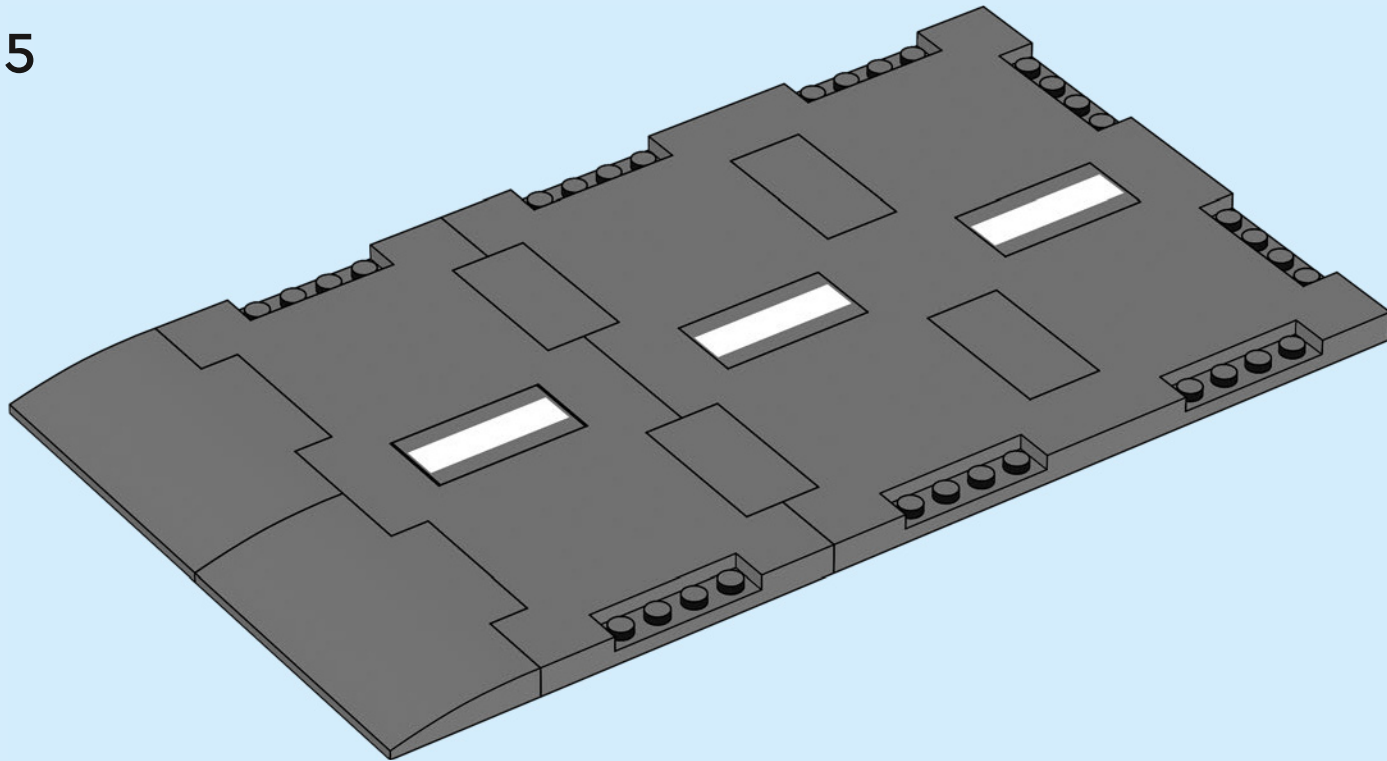

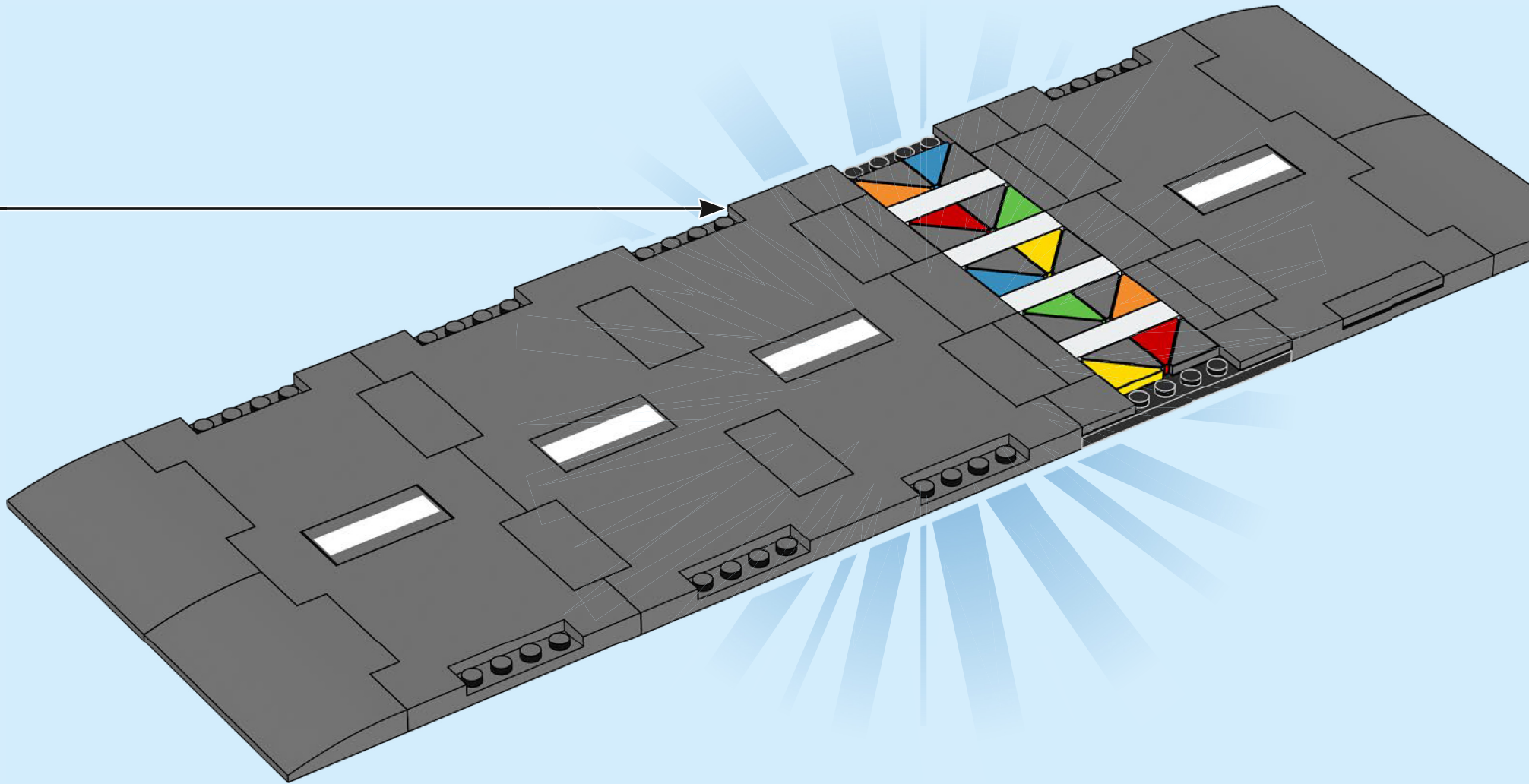

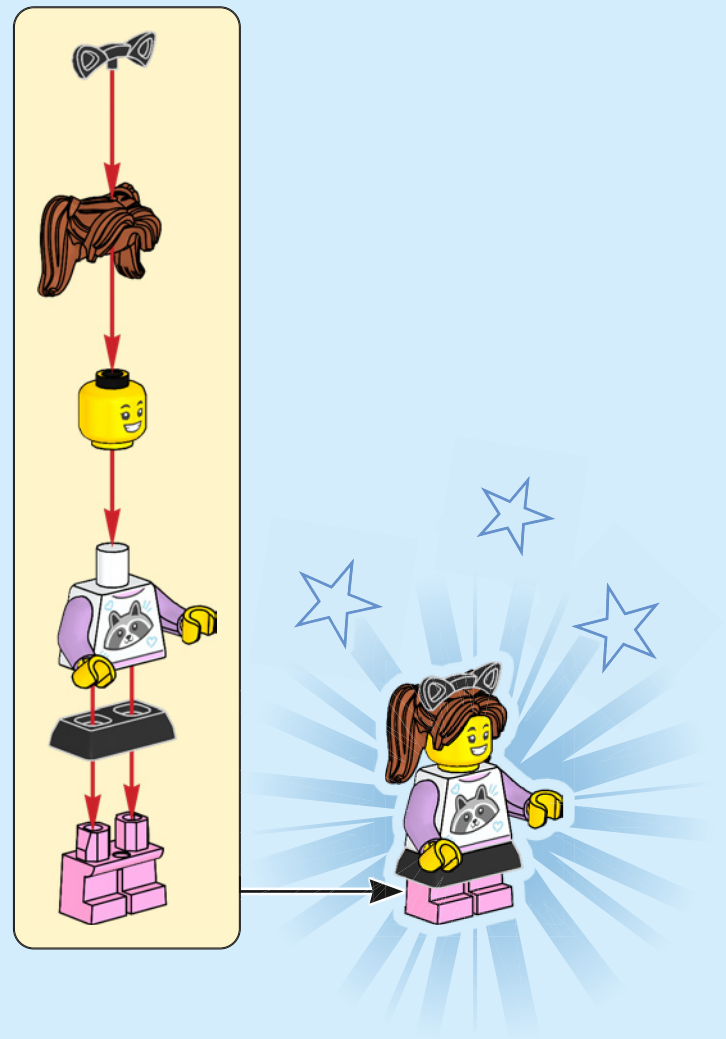
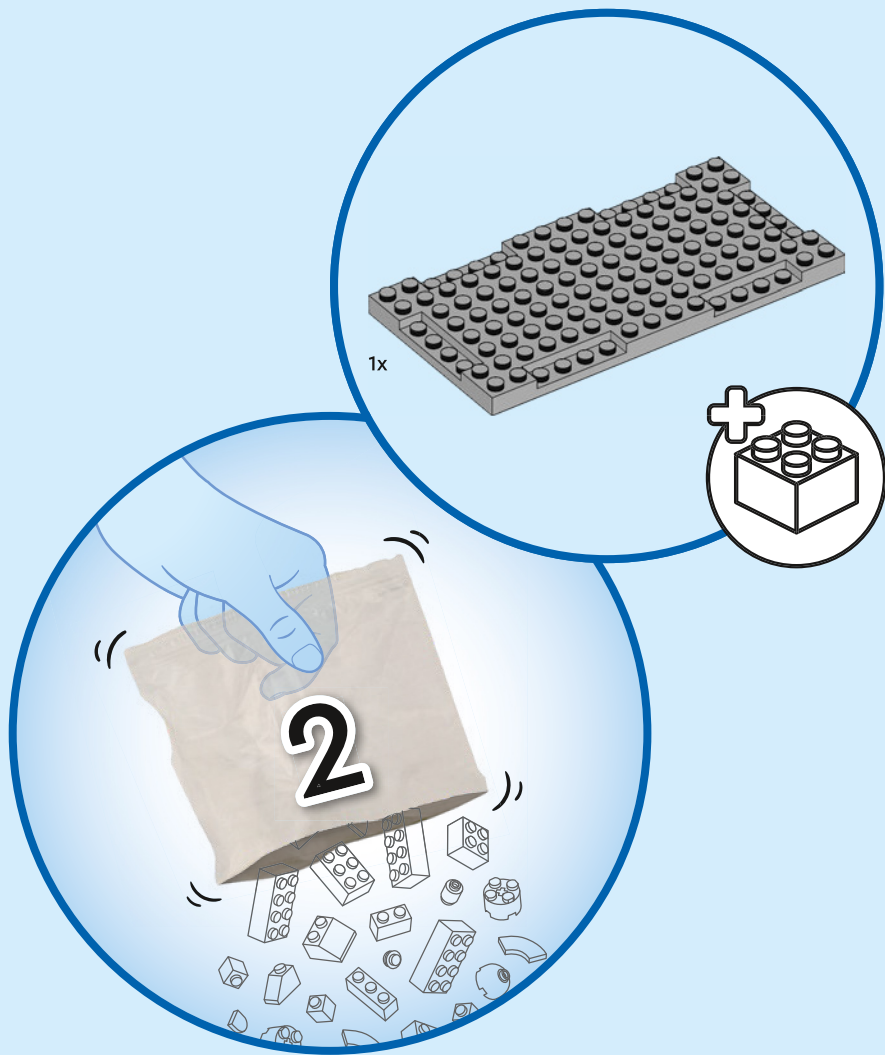

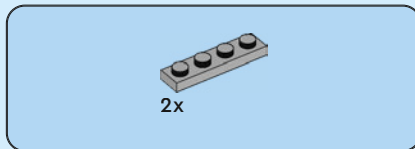
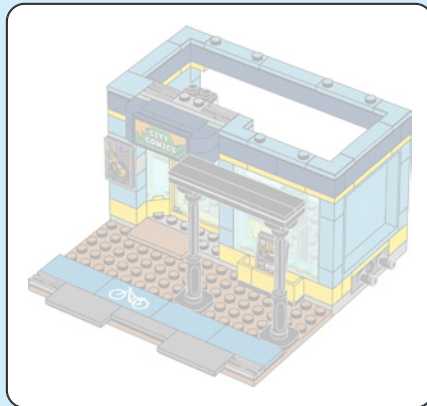
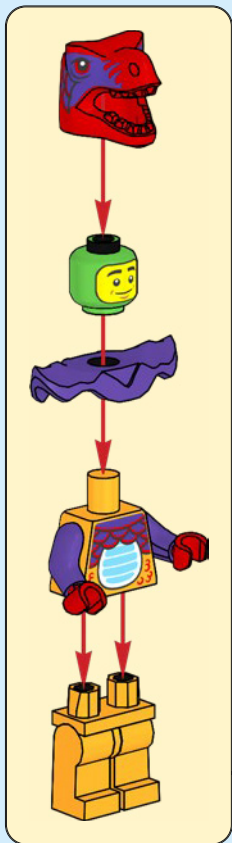
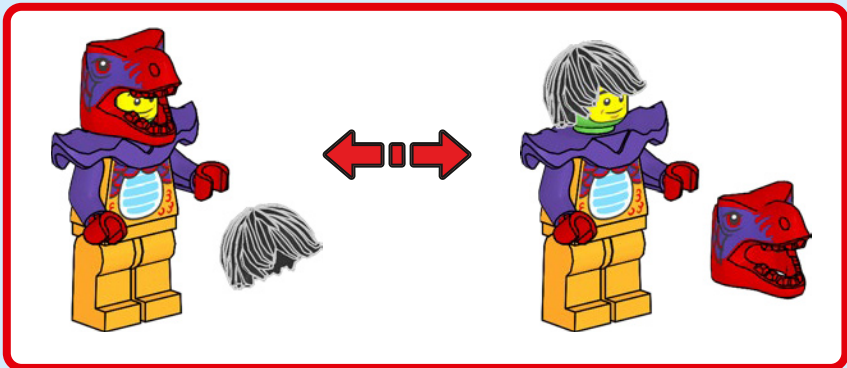

11

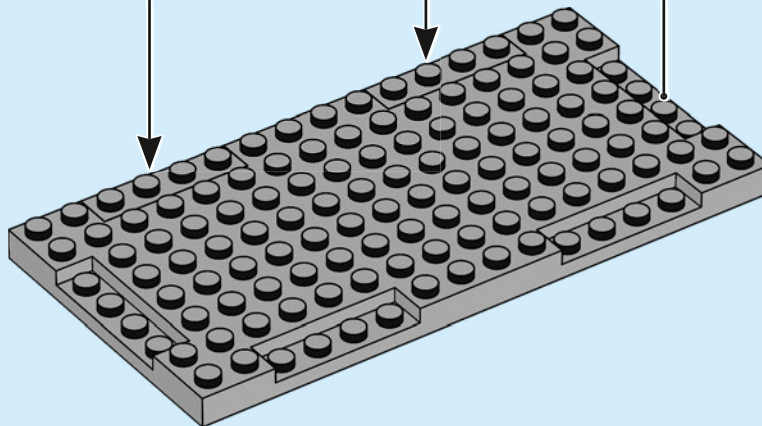
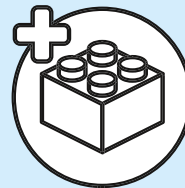
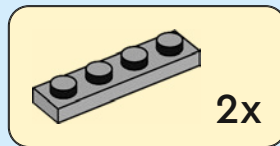

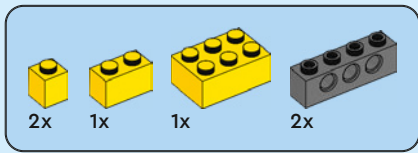

12

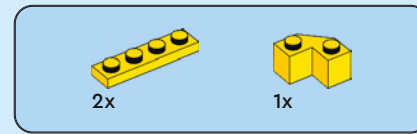
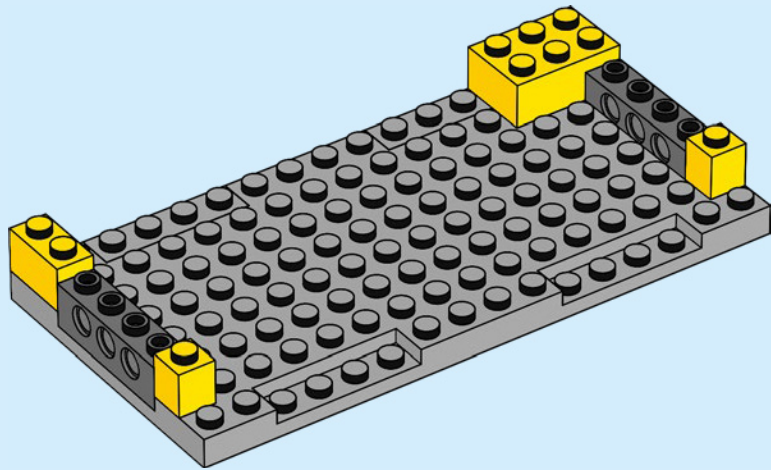

13

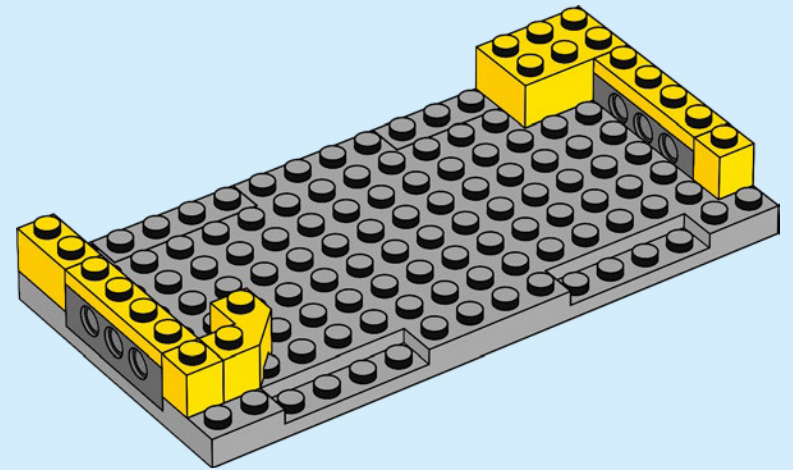

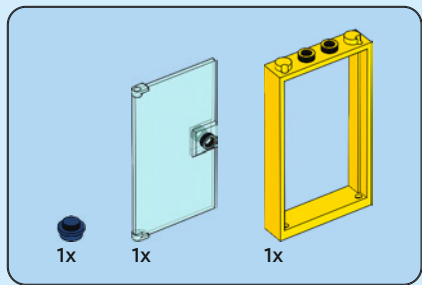

14

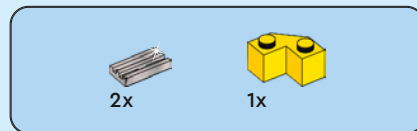
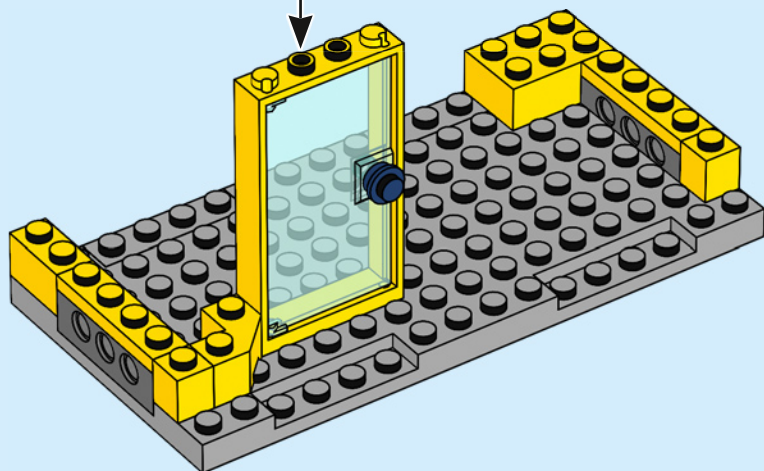
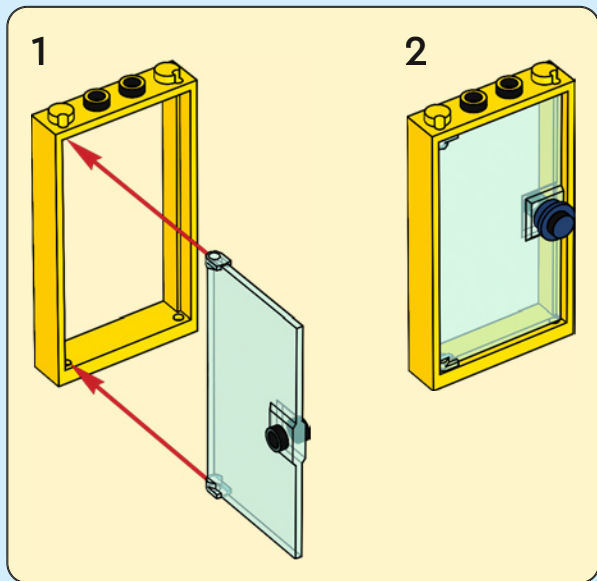

15

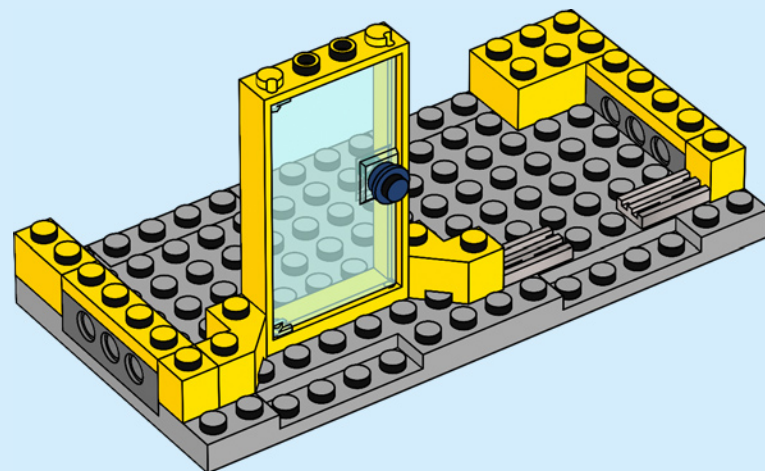

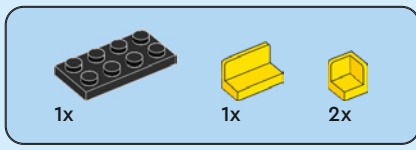

16

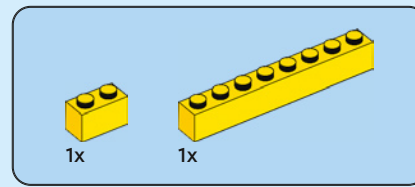
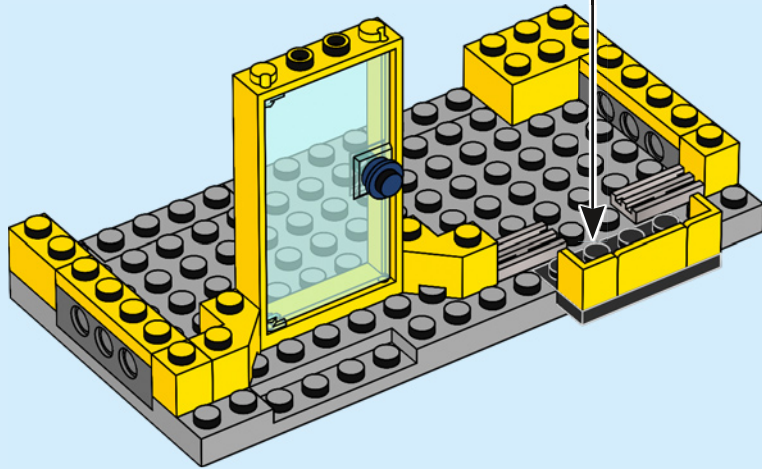
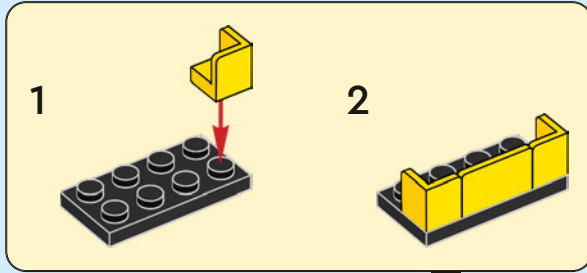

17

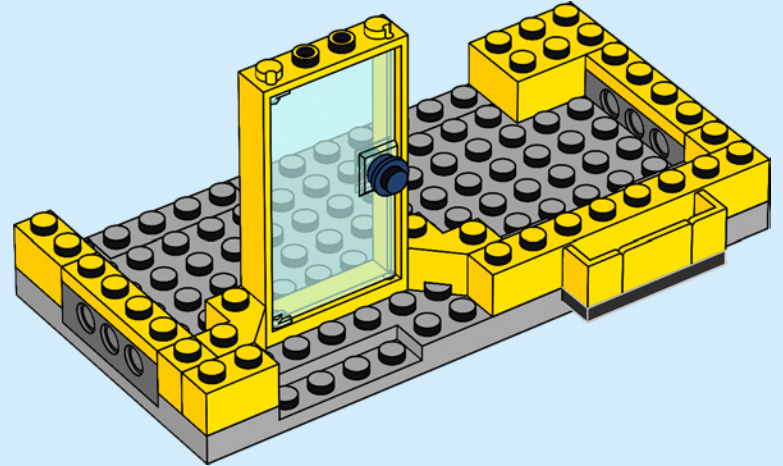



2x

18

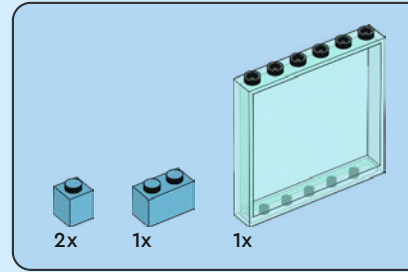
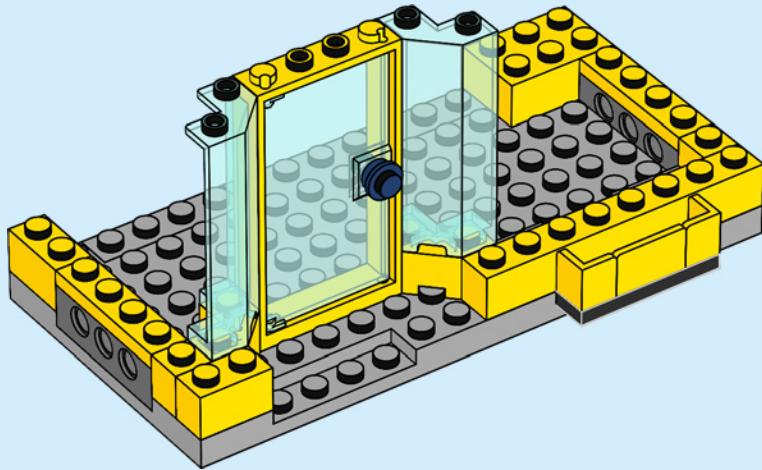

19

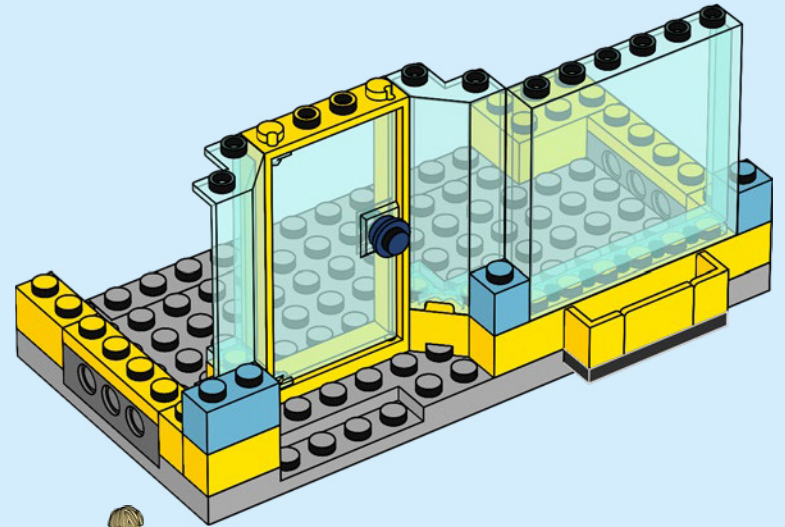

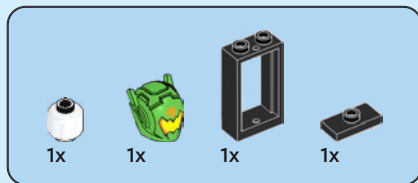

20

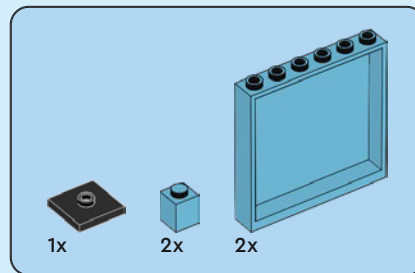
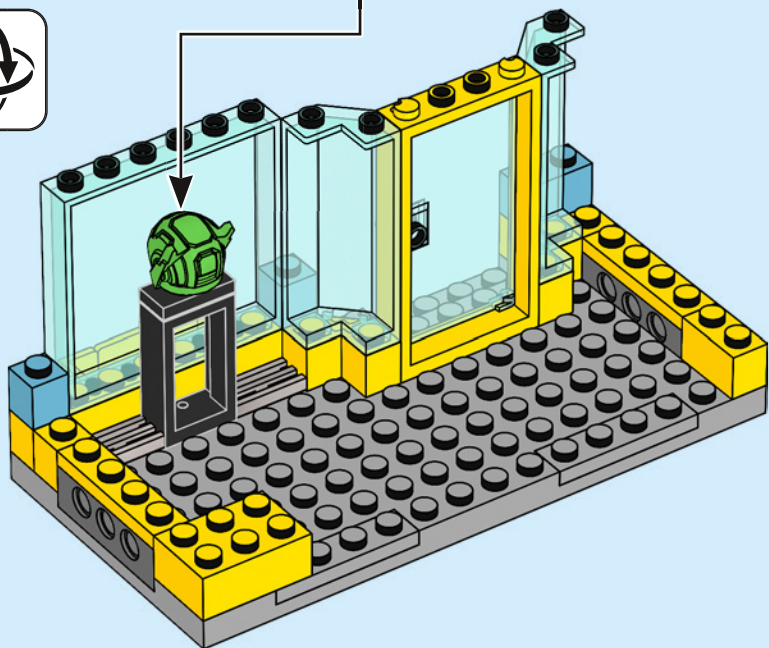
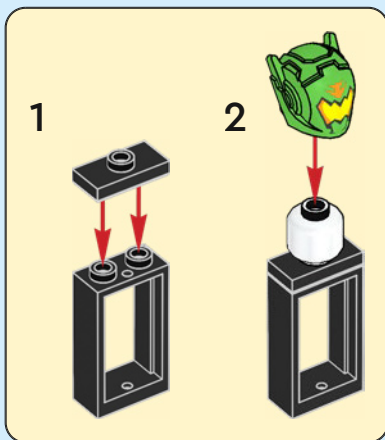

21

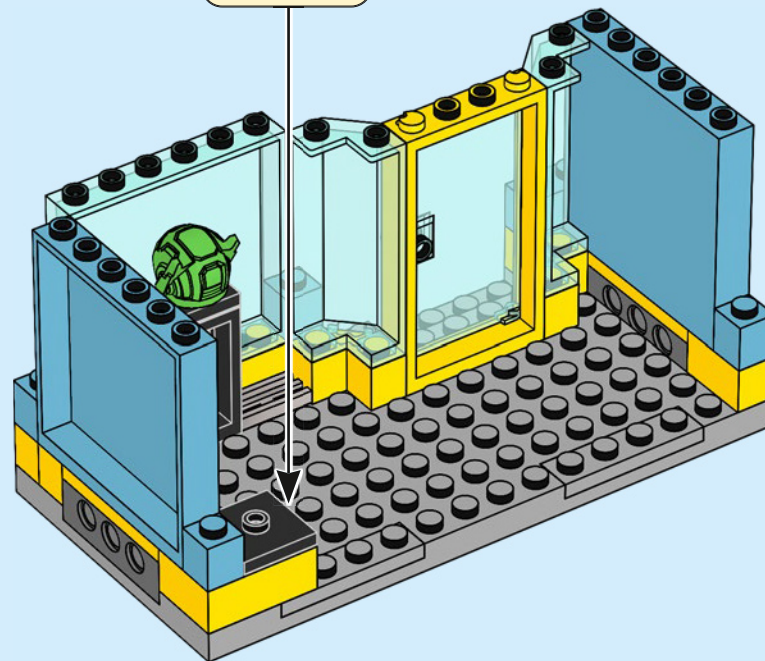
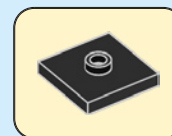

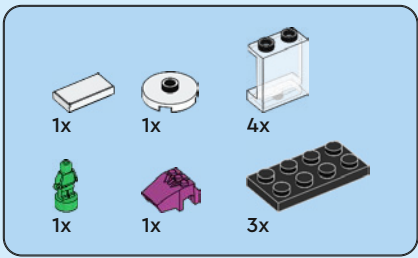

22

1

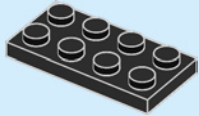

2

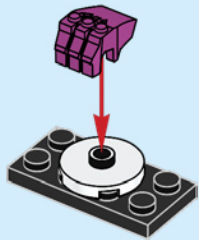

3

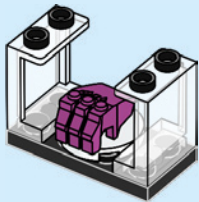

4

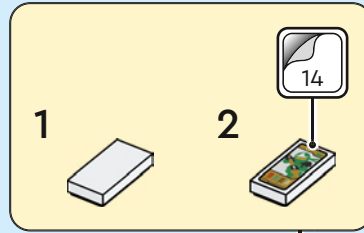
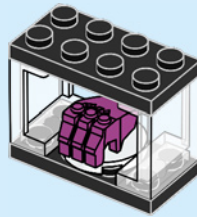

5

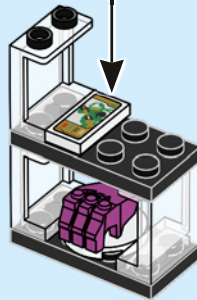

6



7



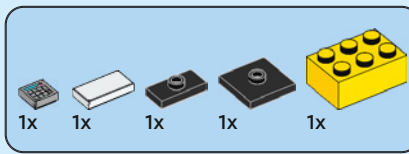

23

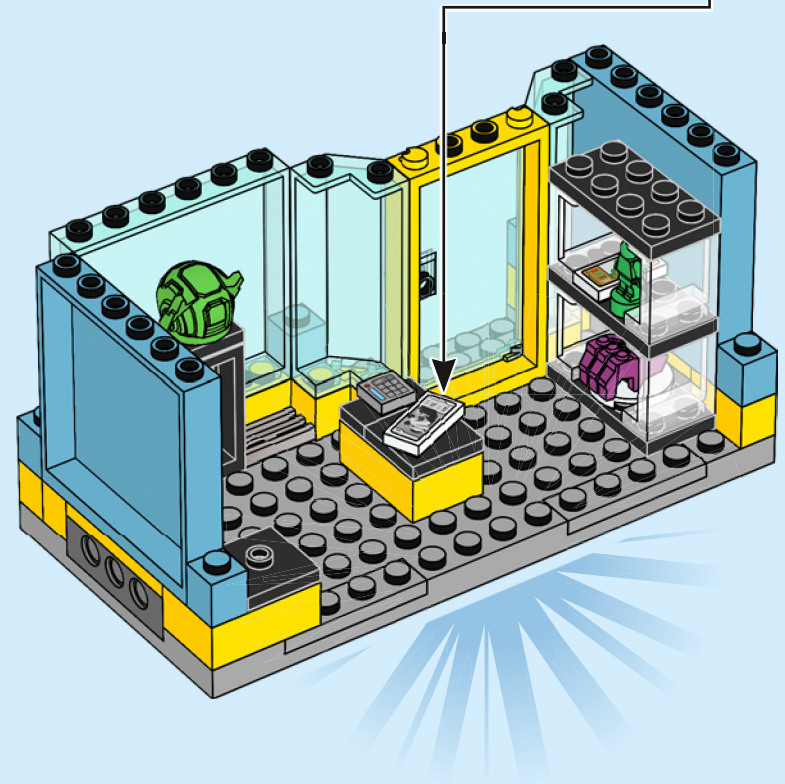
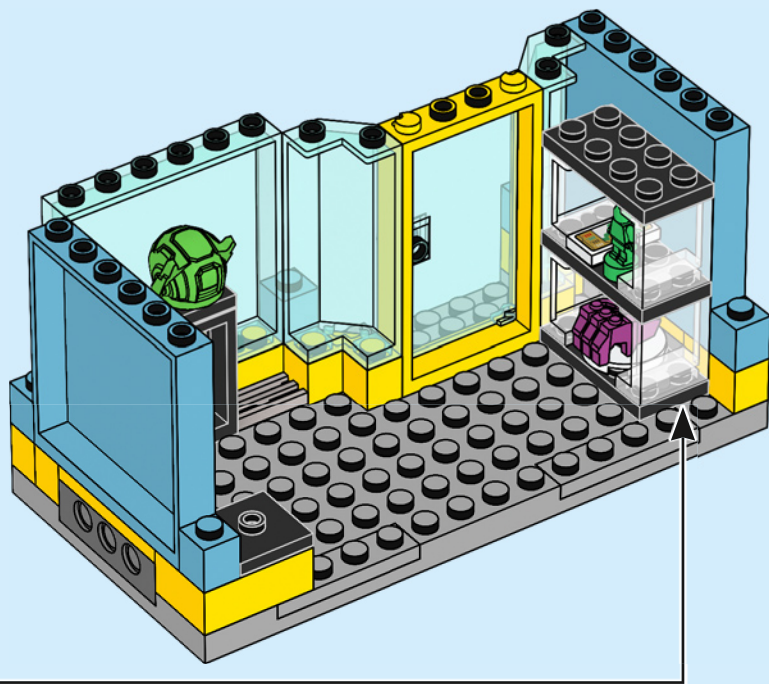
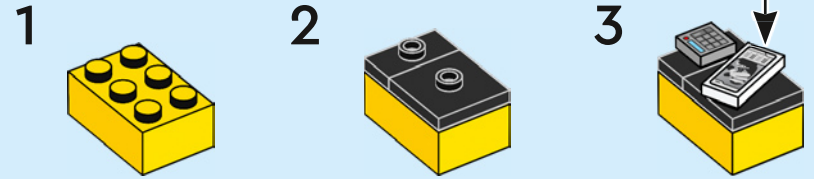
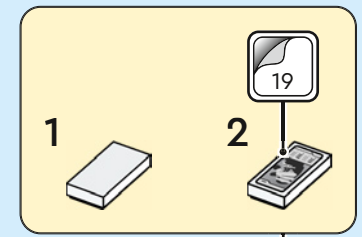

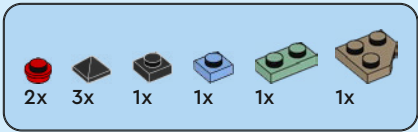

24

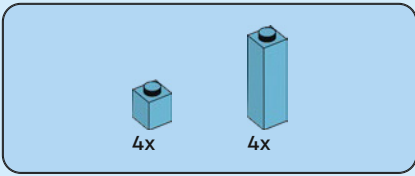
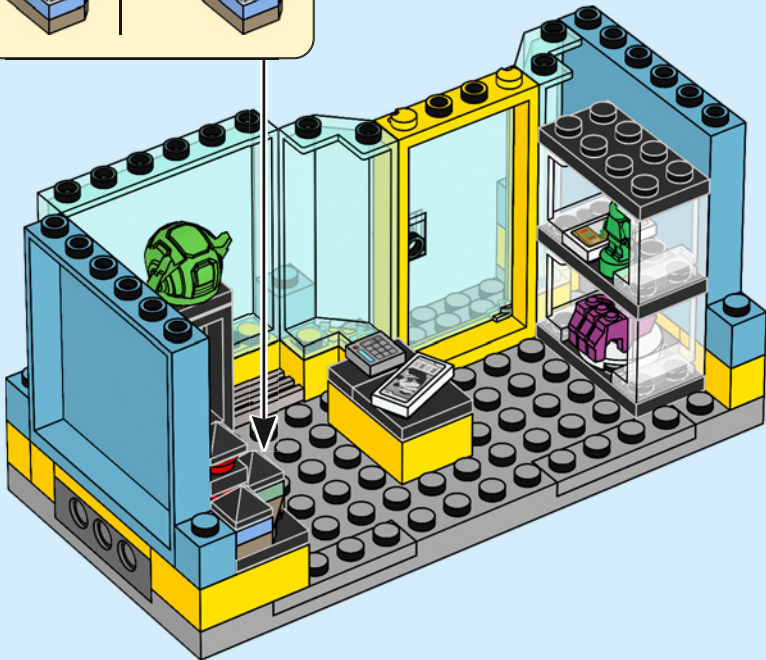
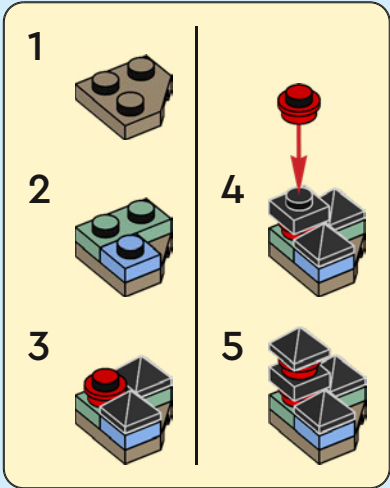

25

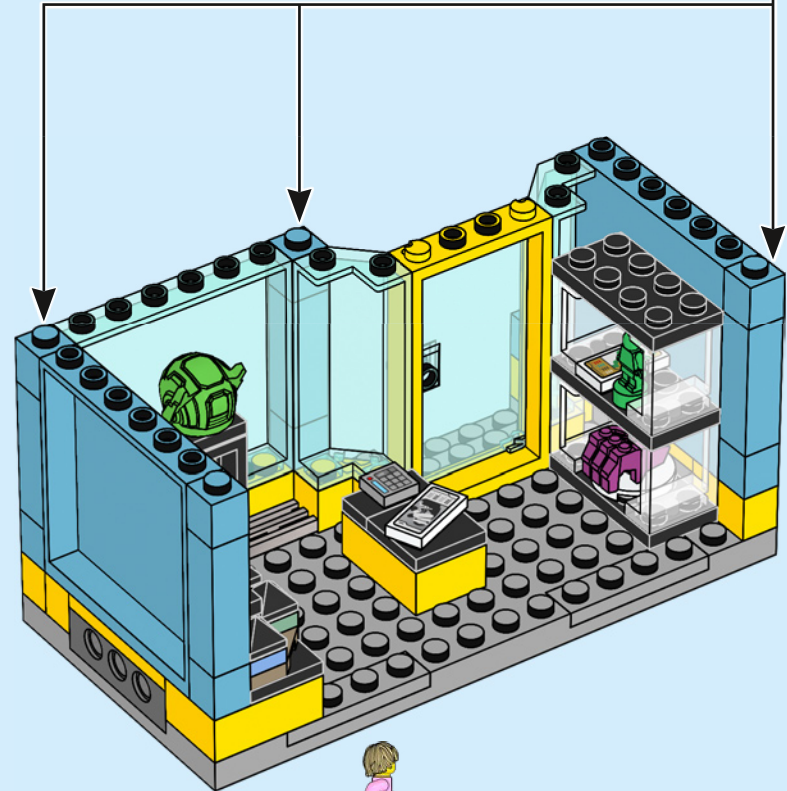
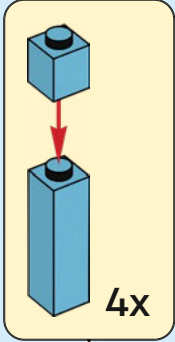

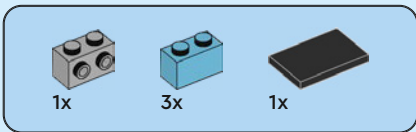

26

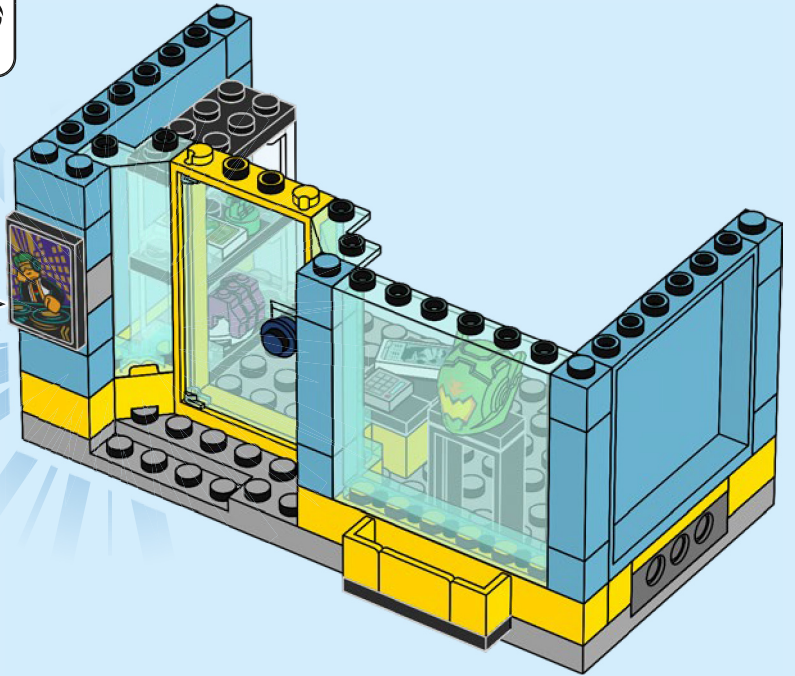
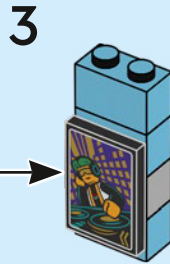
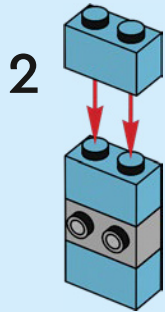
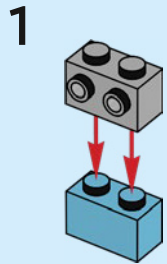
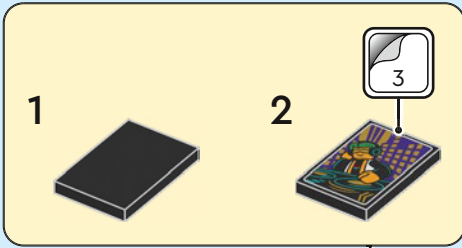

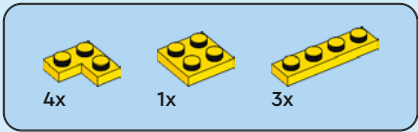

27

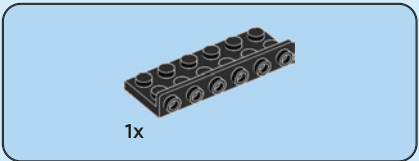
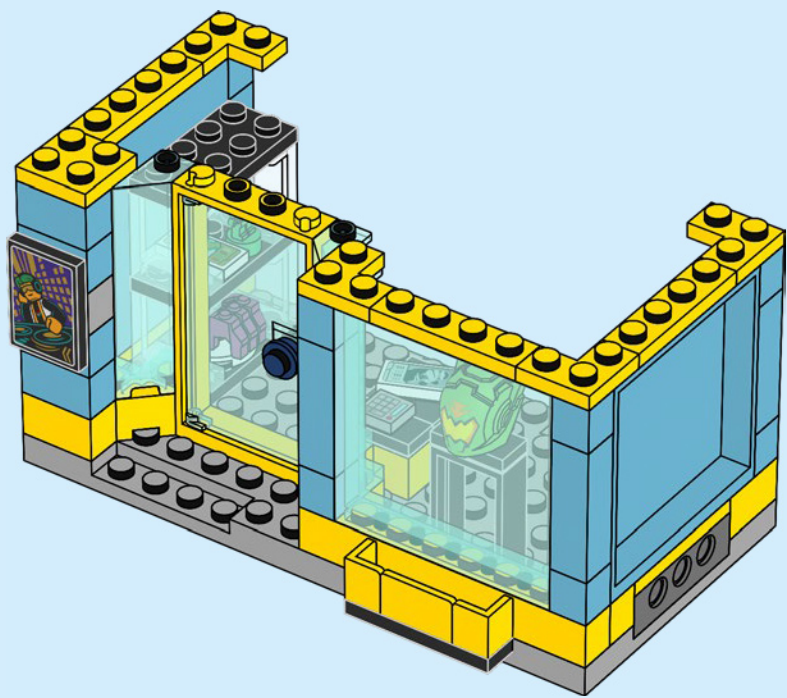

28

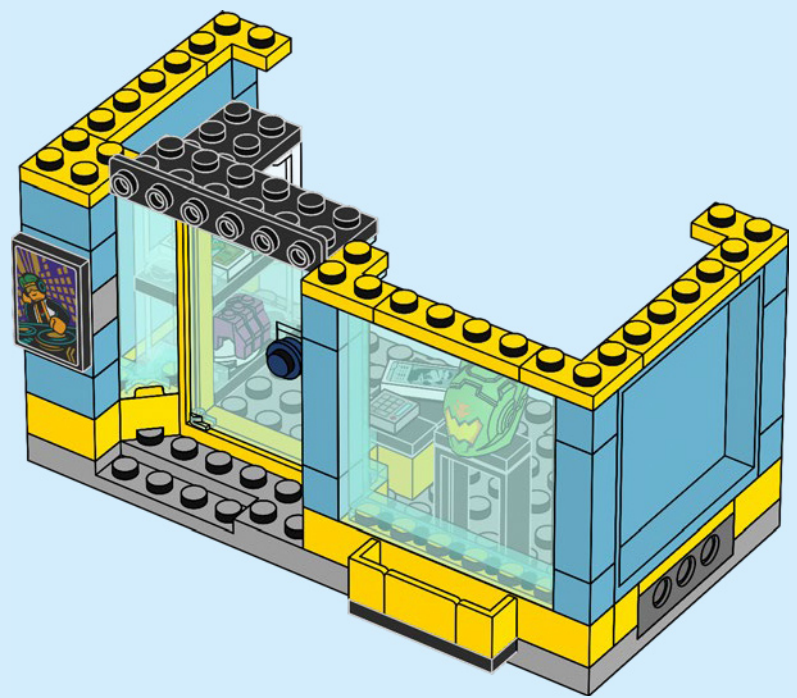

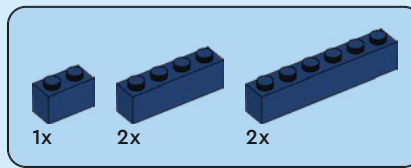
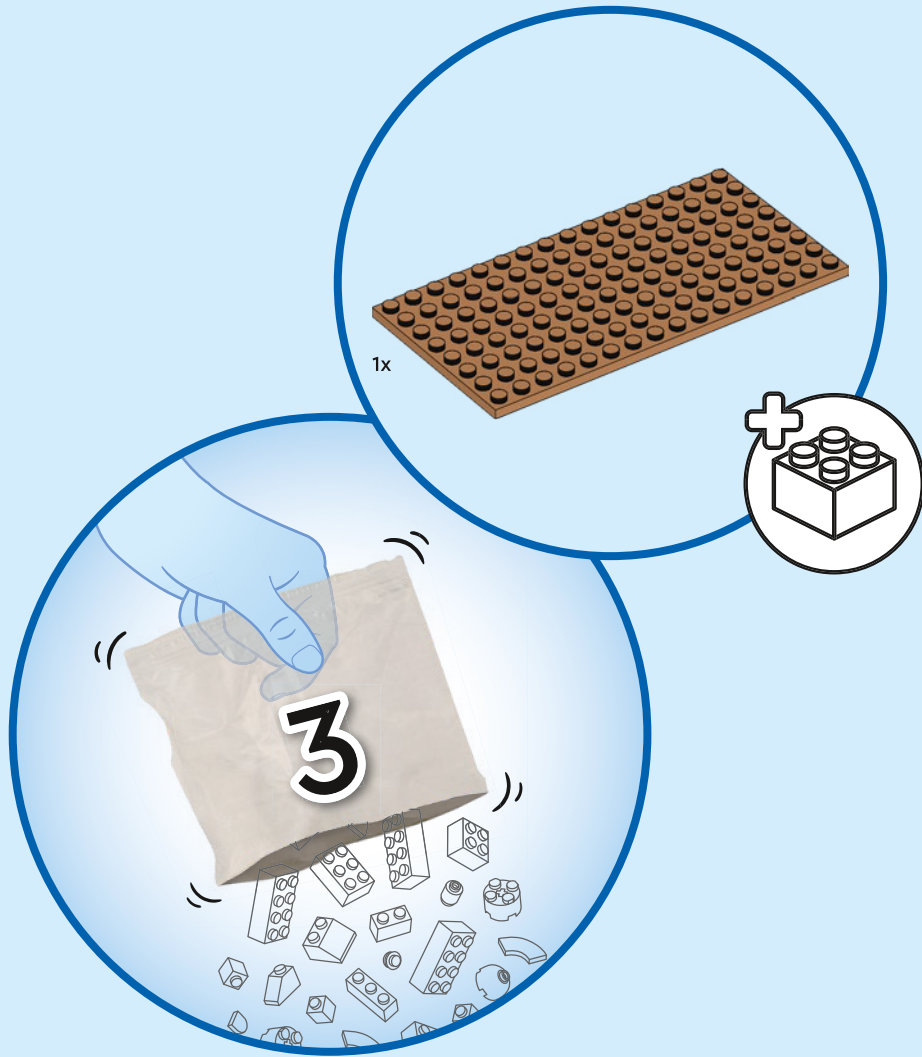

29

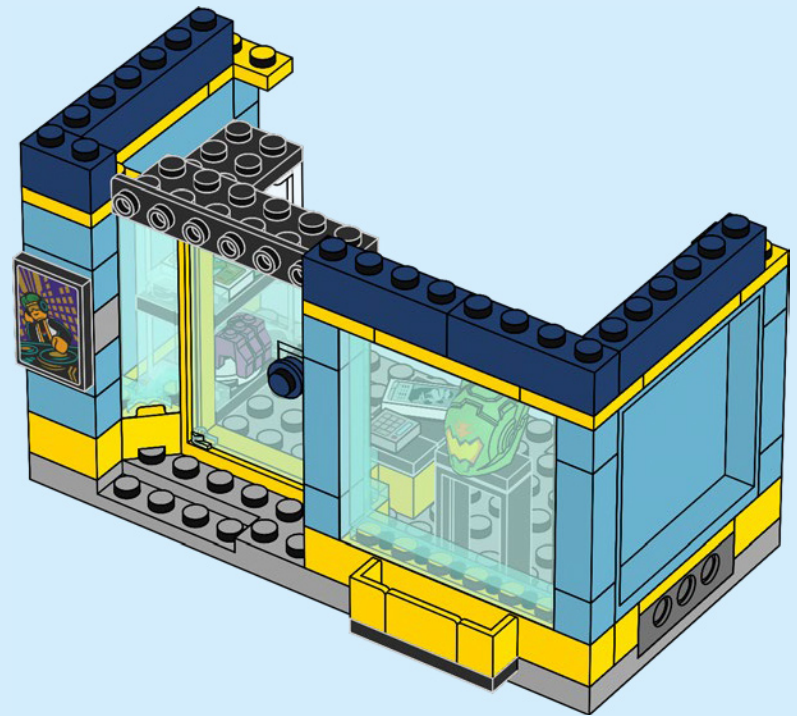

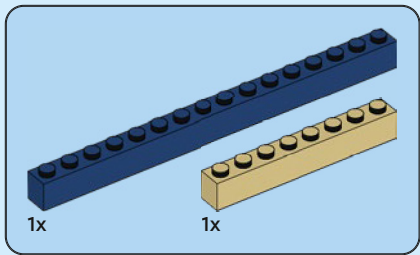

30

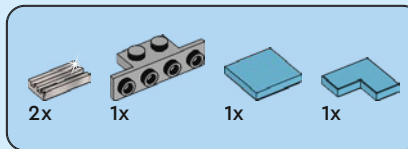
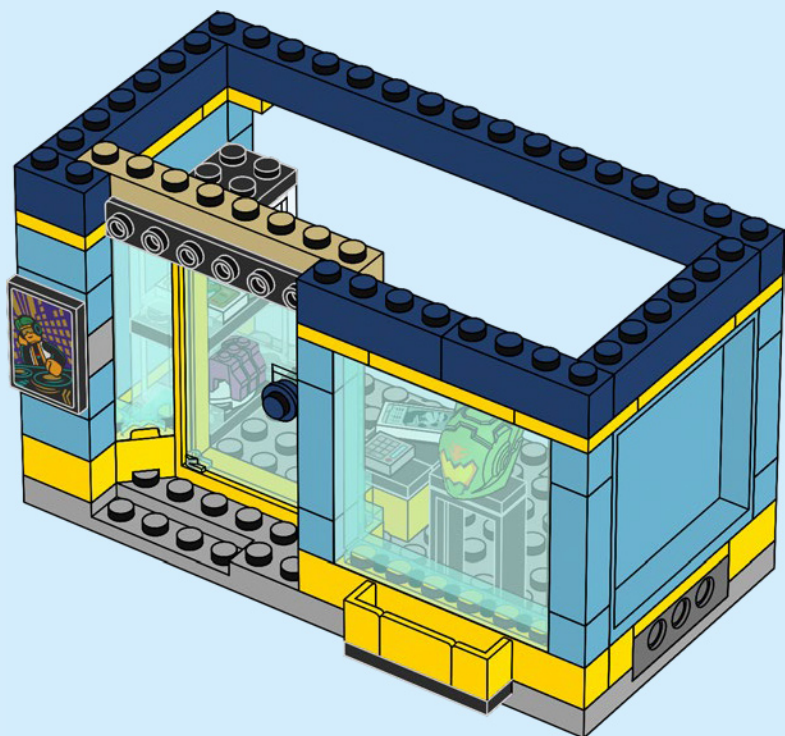

31

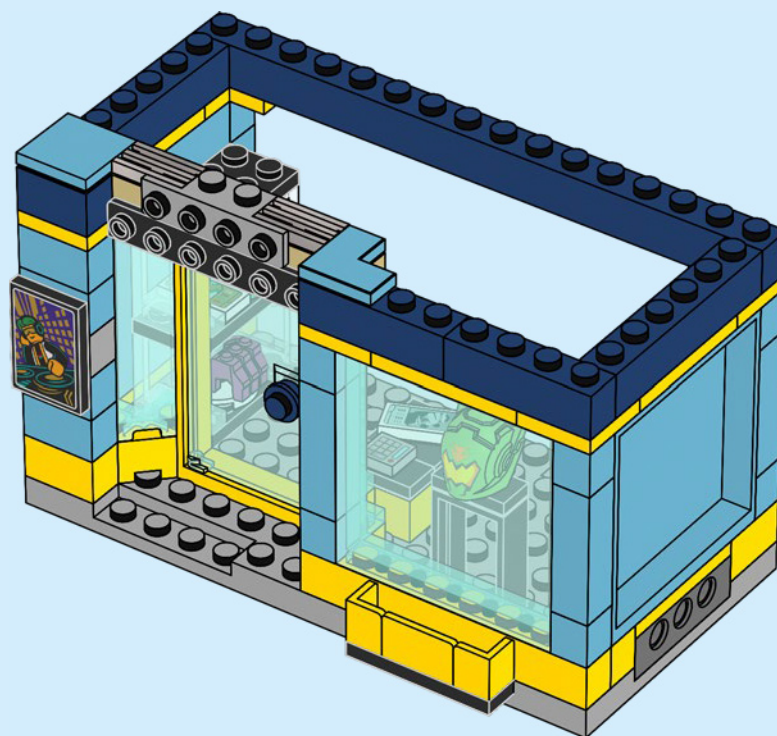

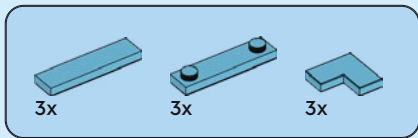

32

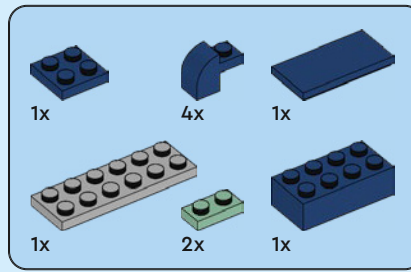
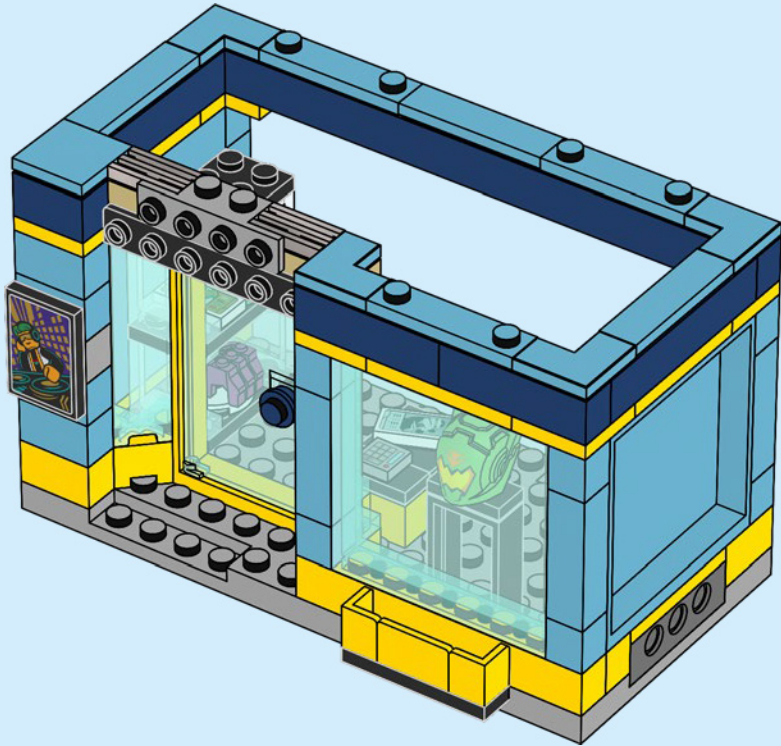

33

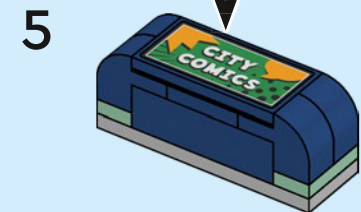
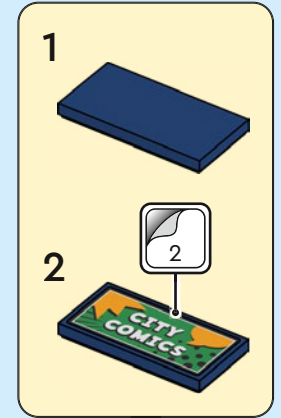
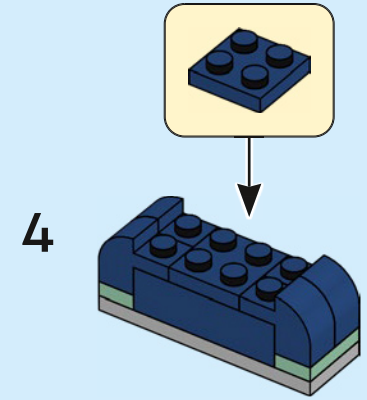
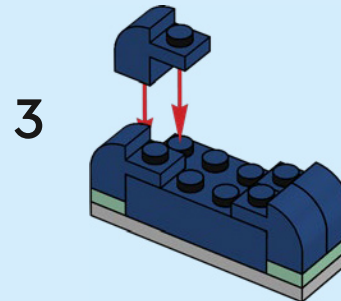
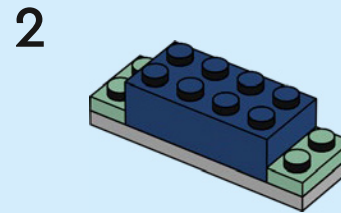
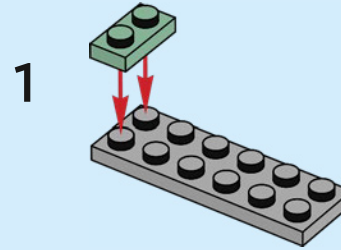

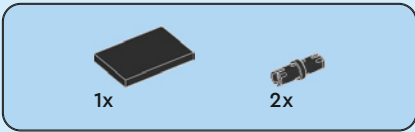

34

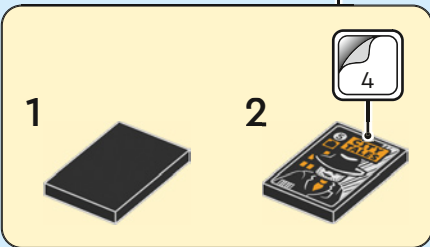
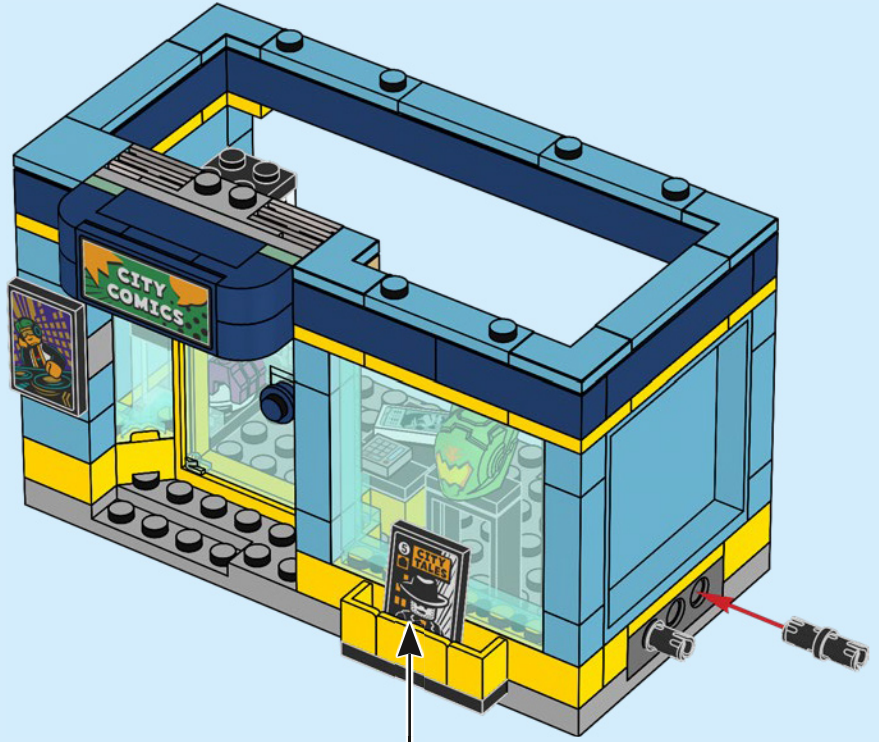
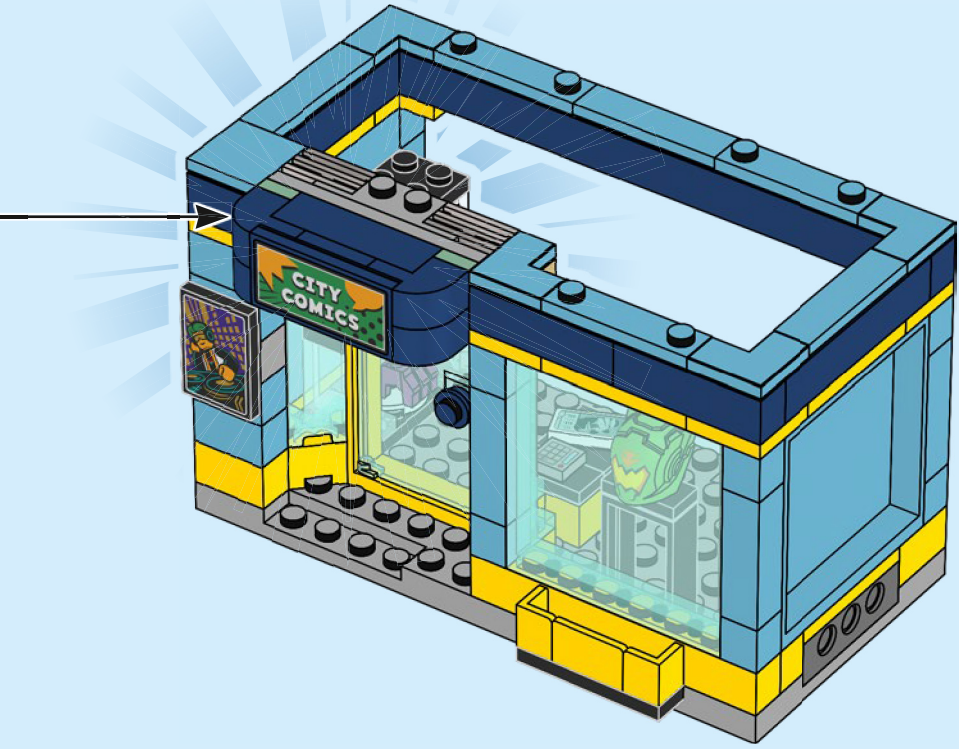

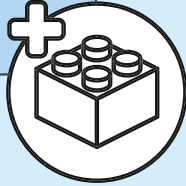
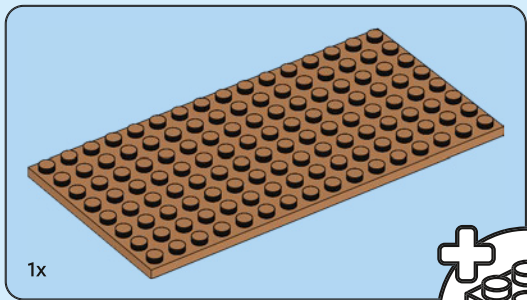

35



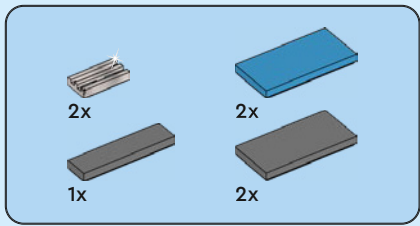

36

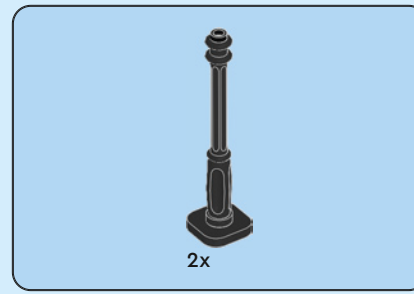

37

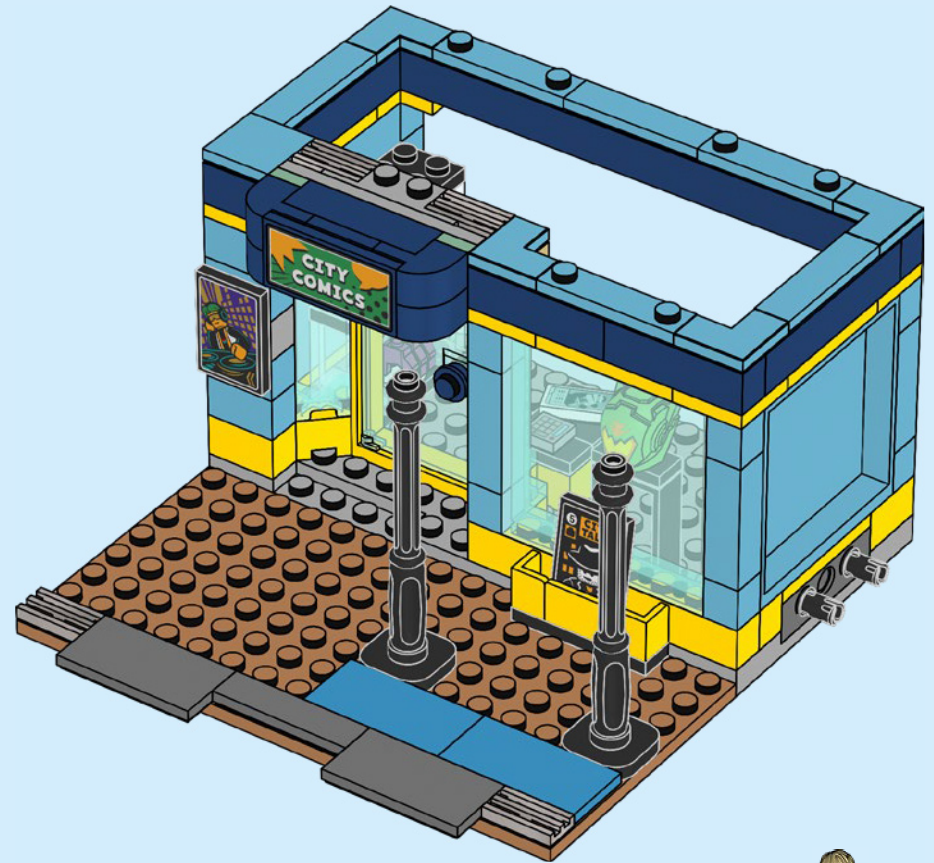

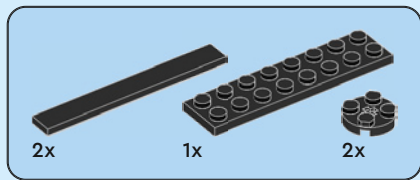

38

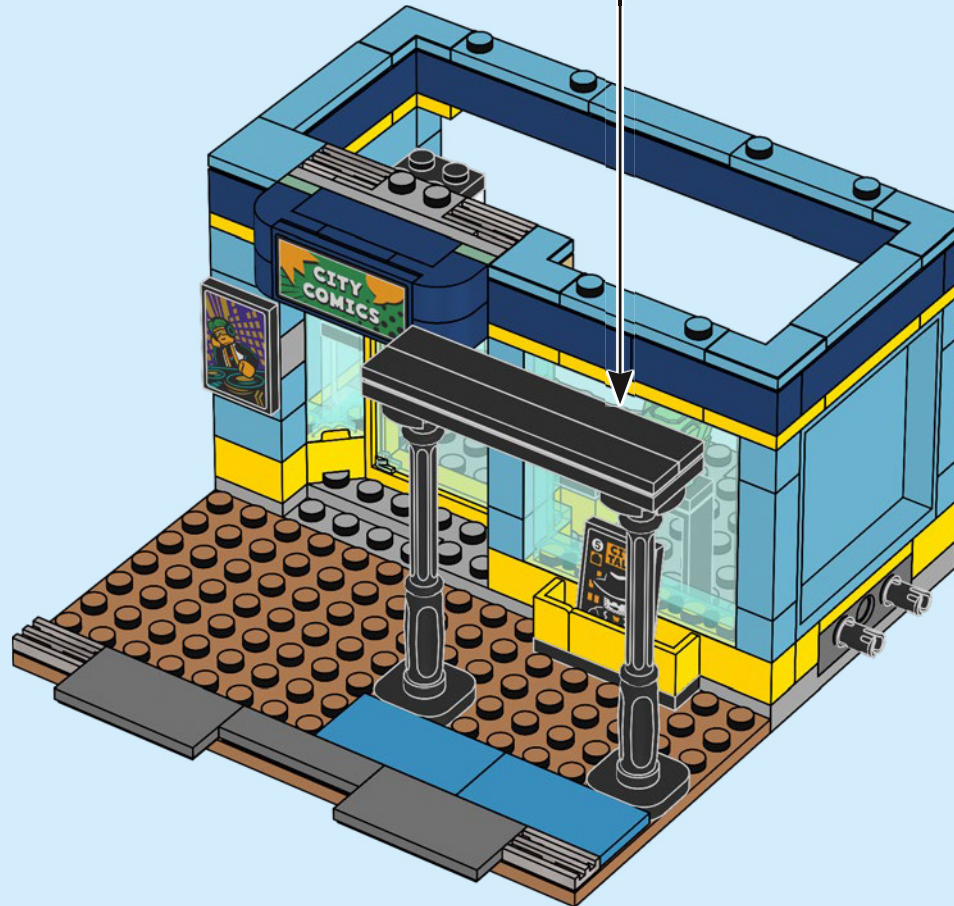
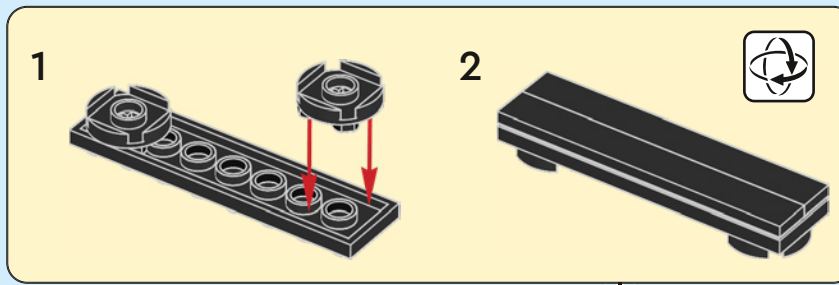

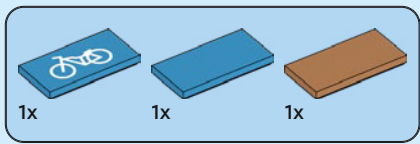

39

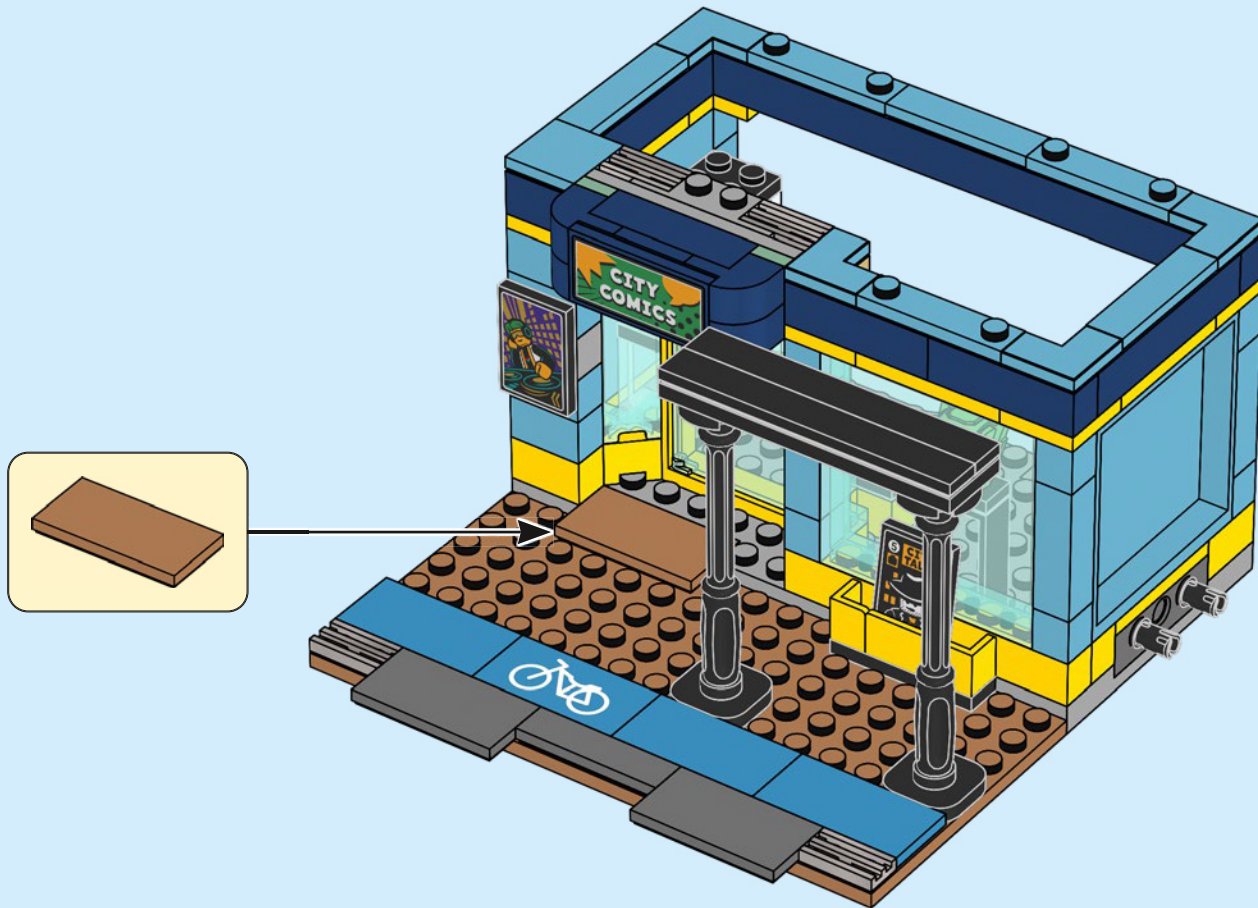

40

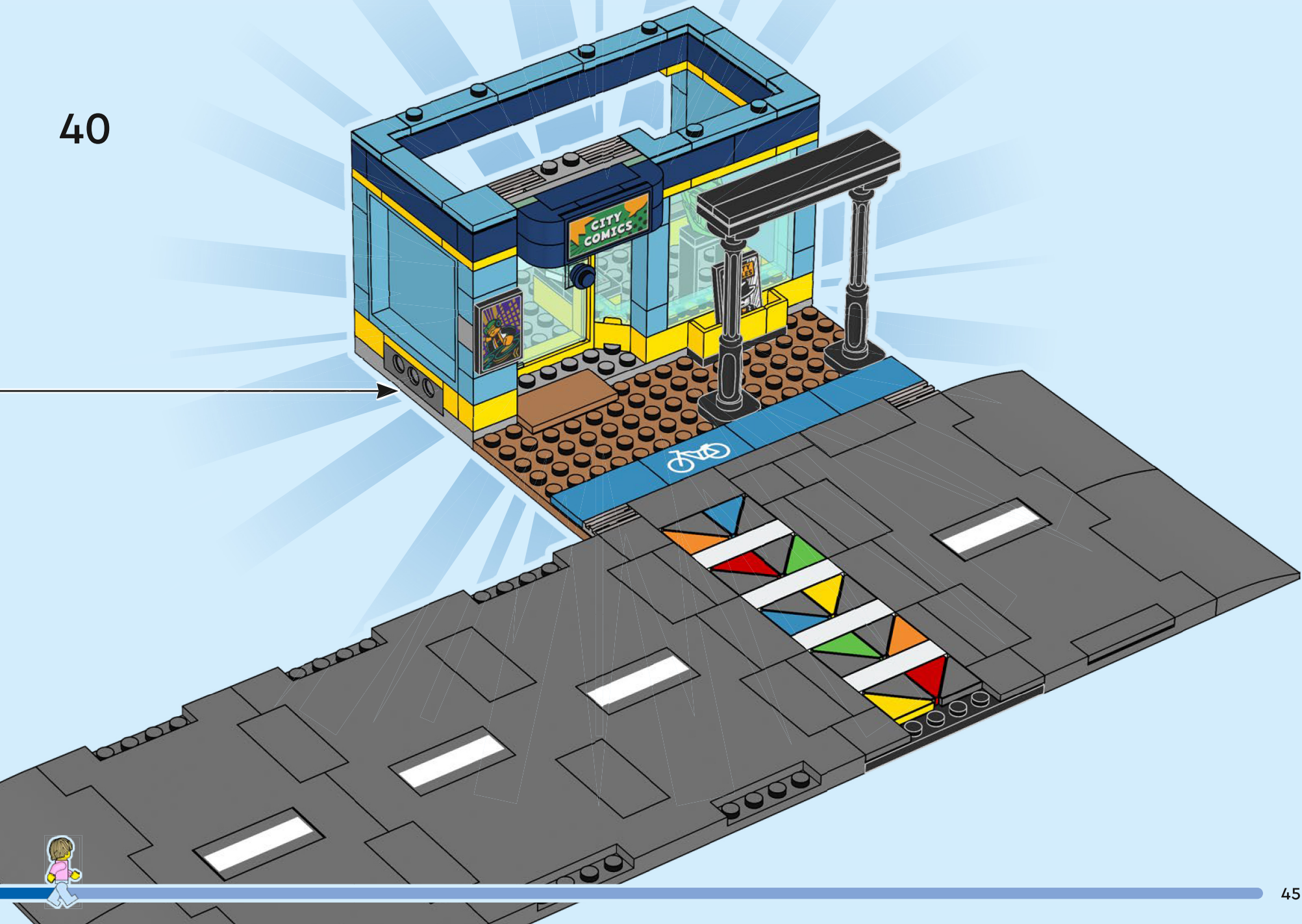

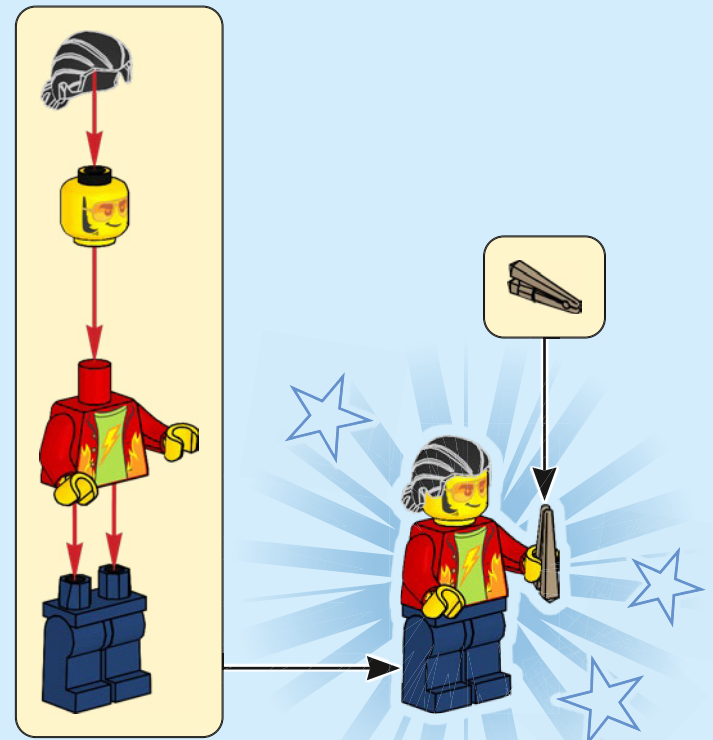
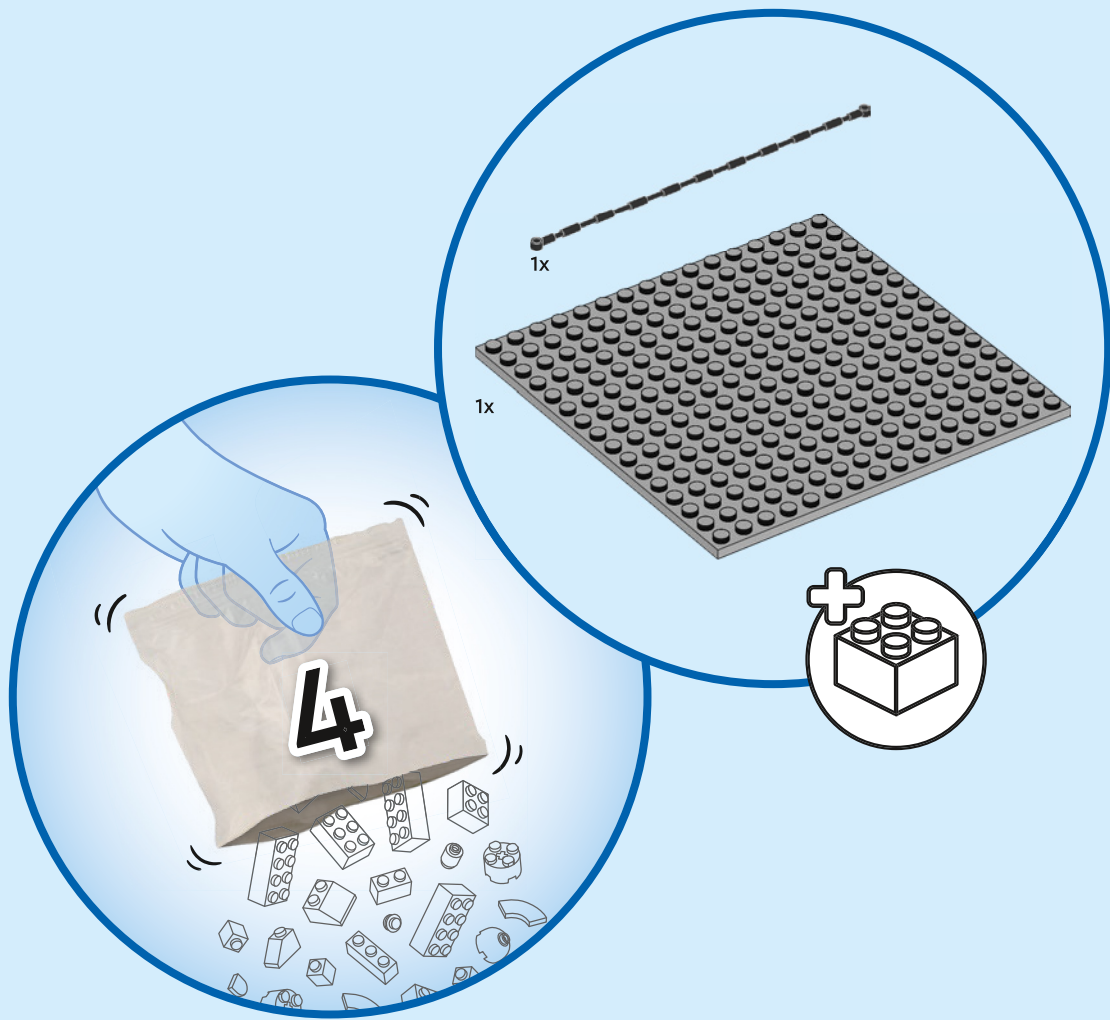

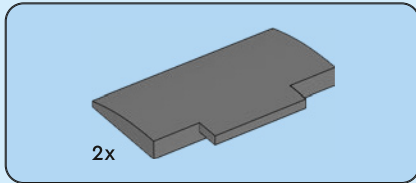
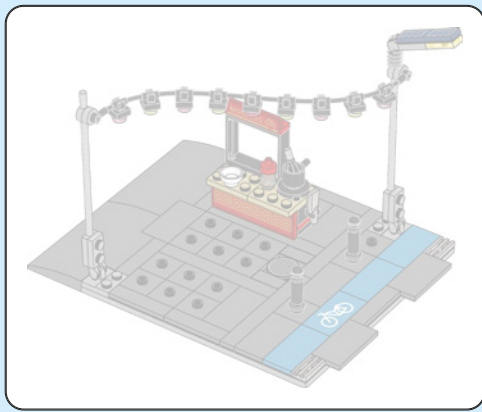

41

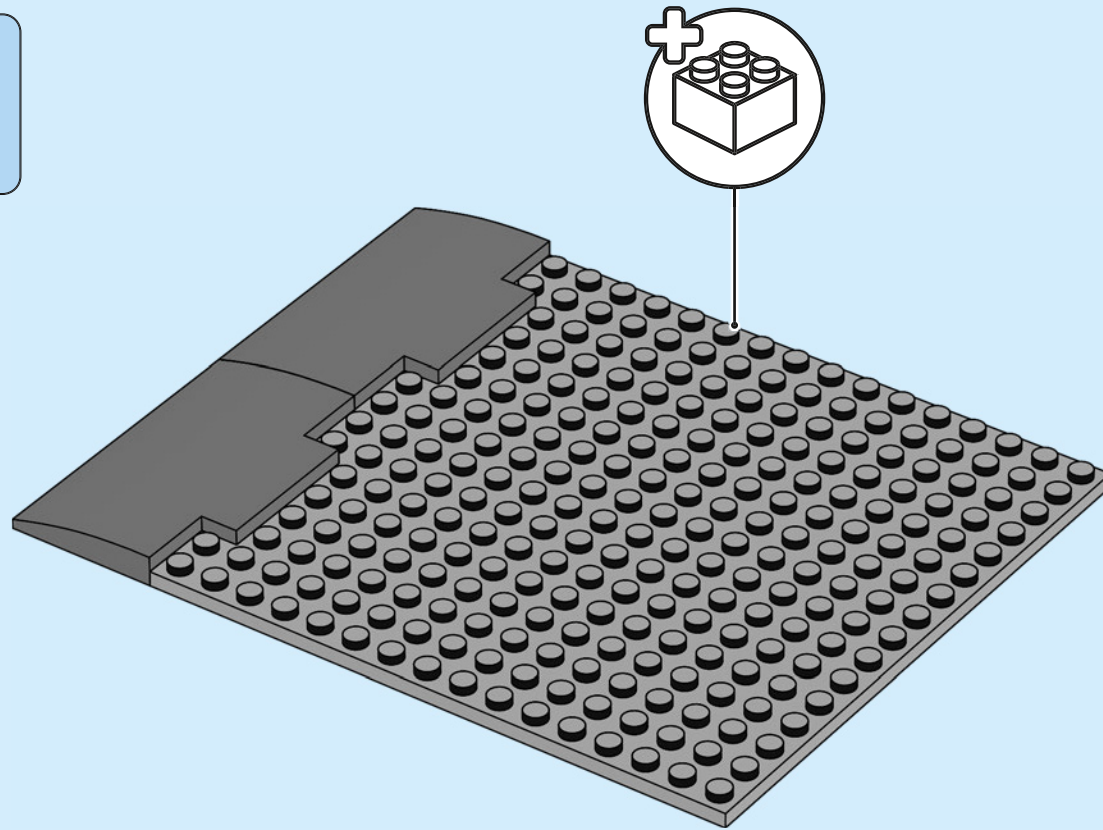

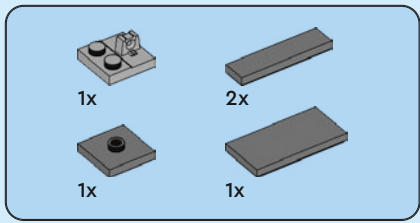

42

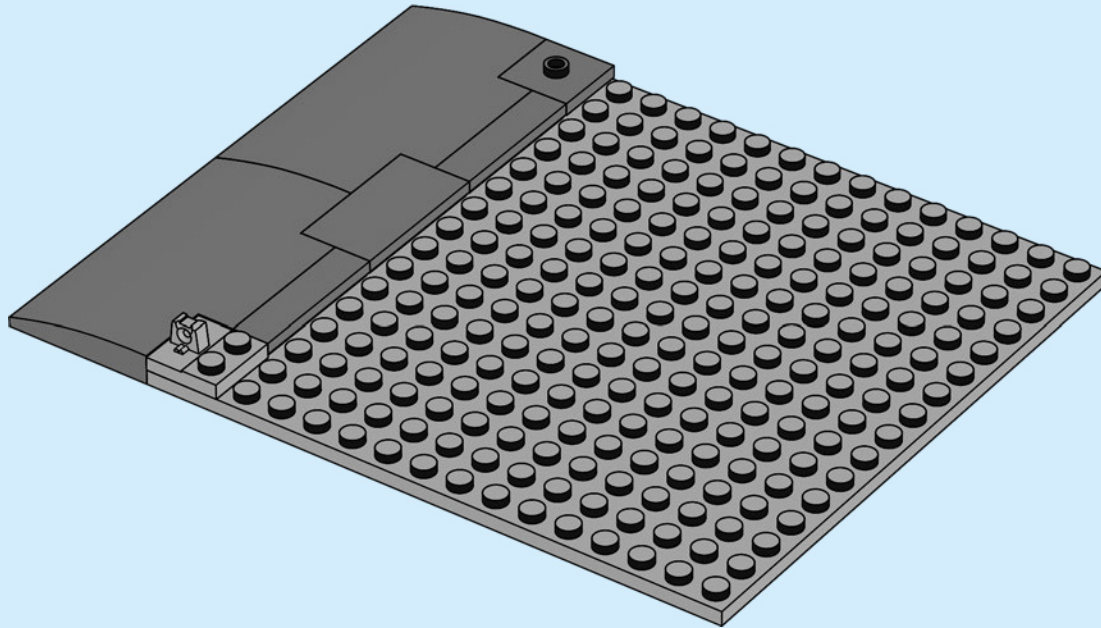

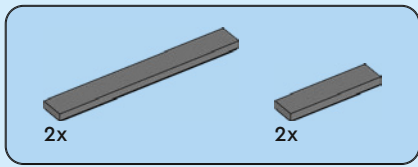

43

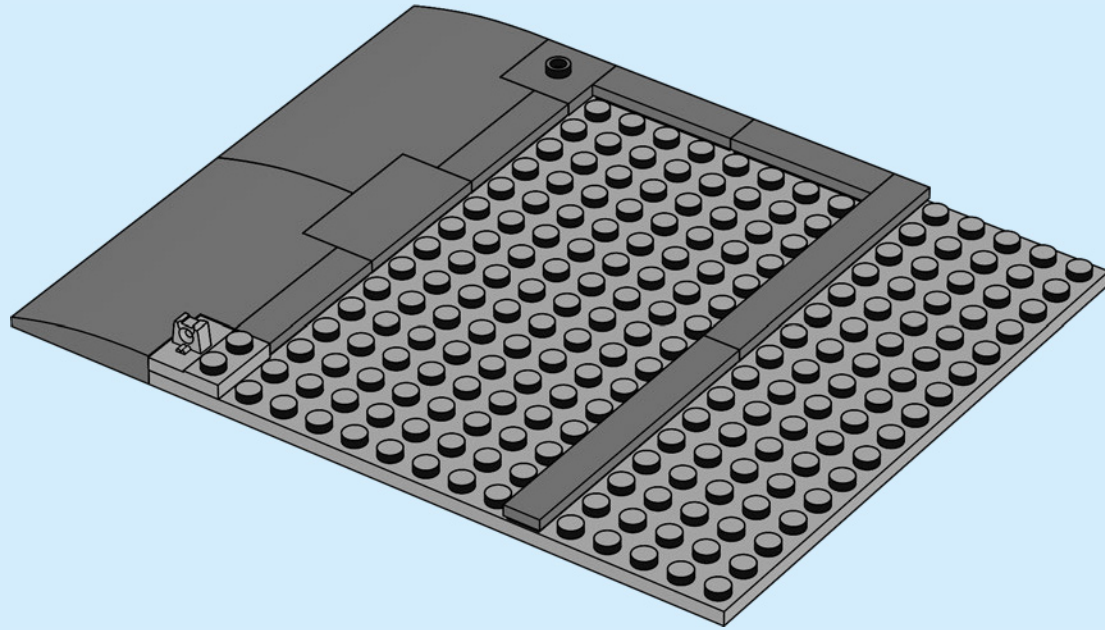

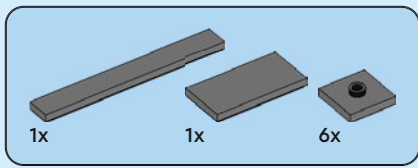

44

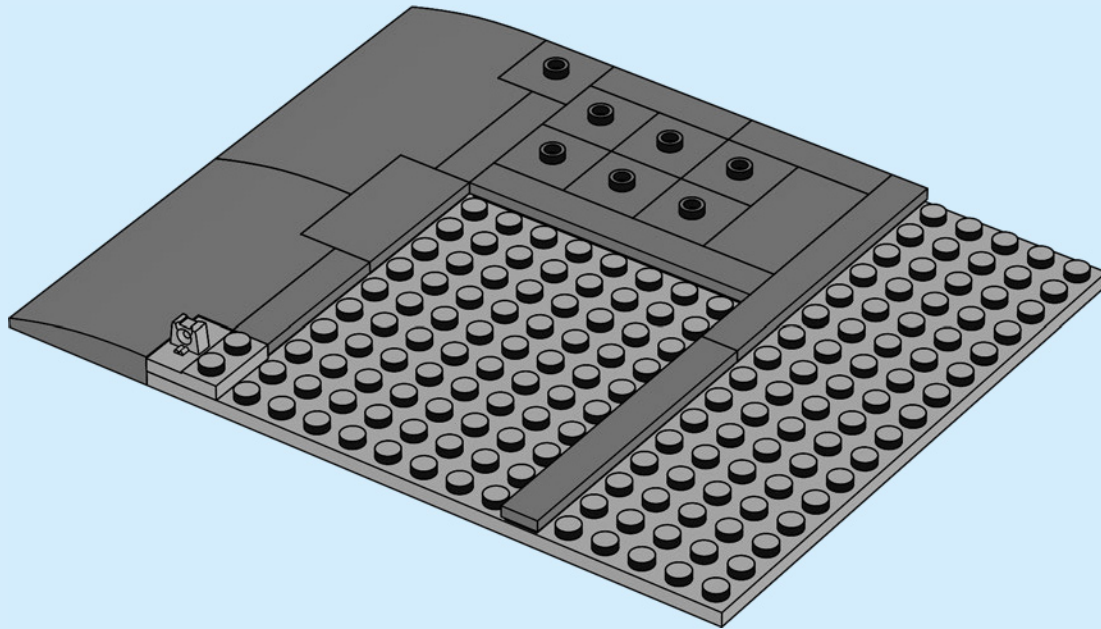

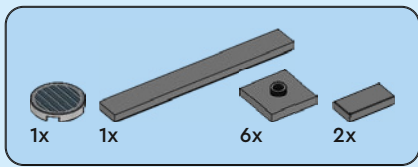

45

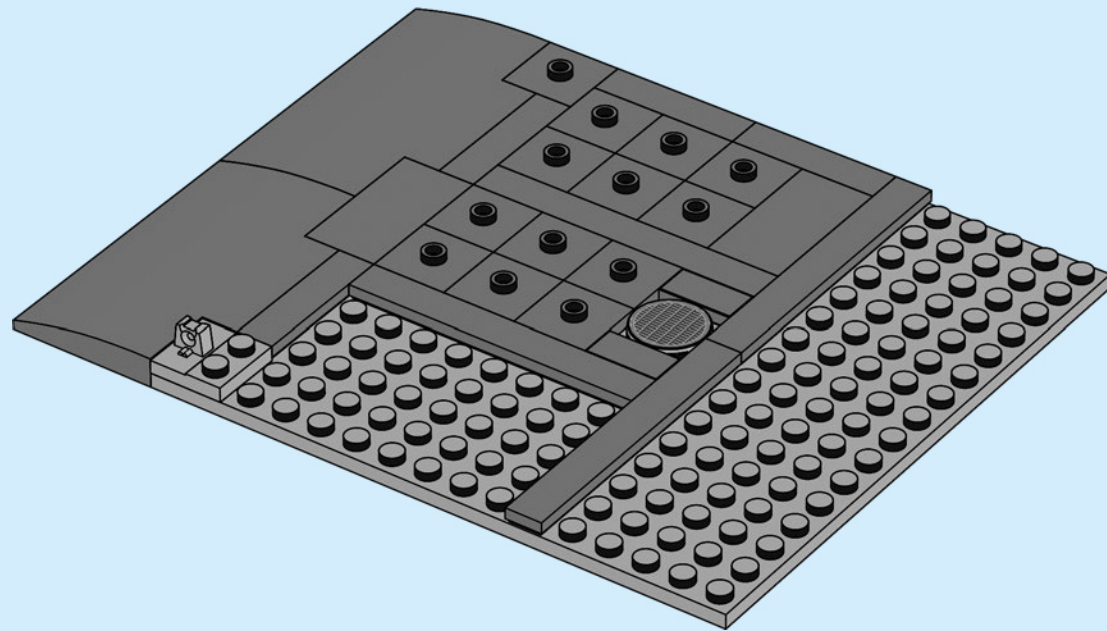

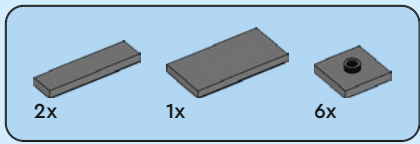

46

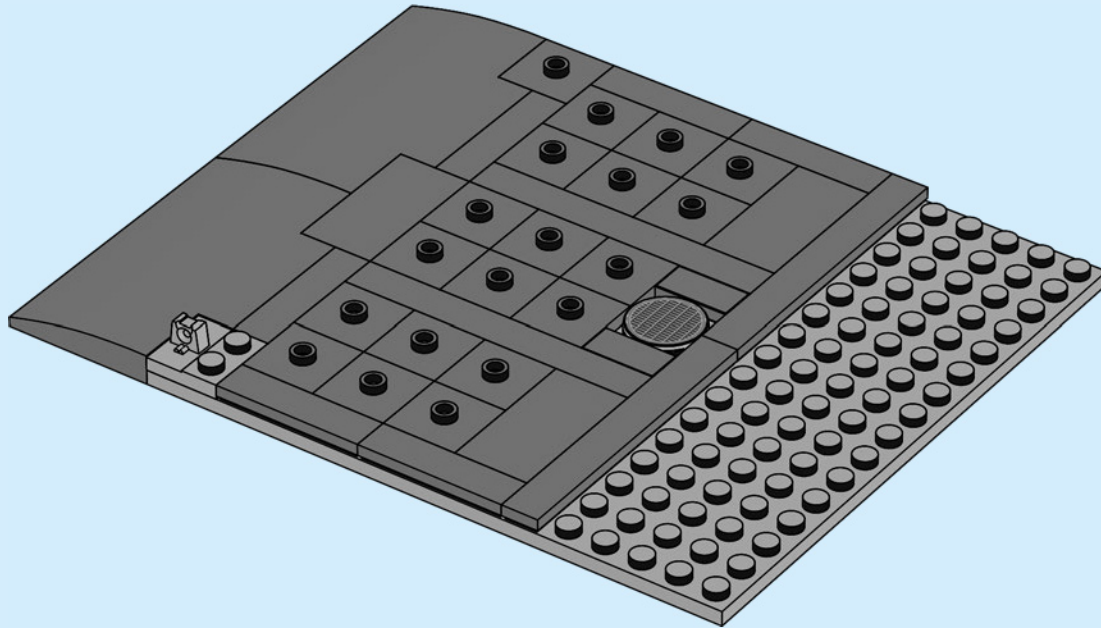

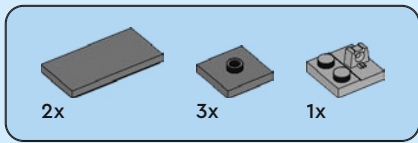

47

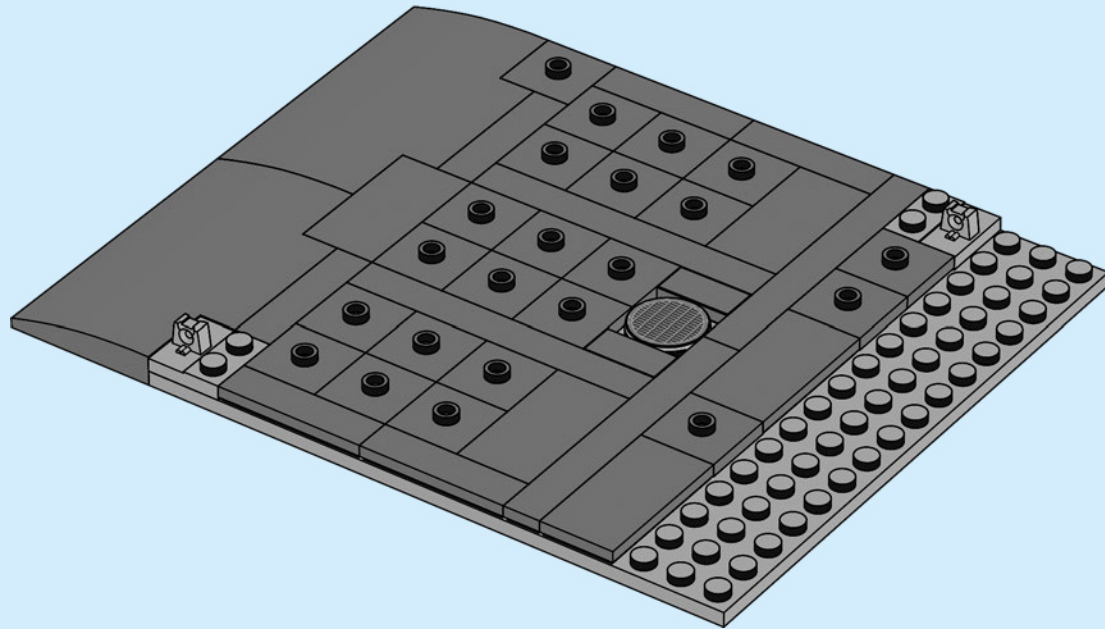

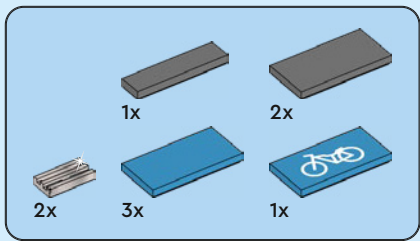

48

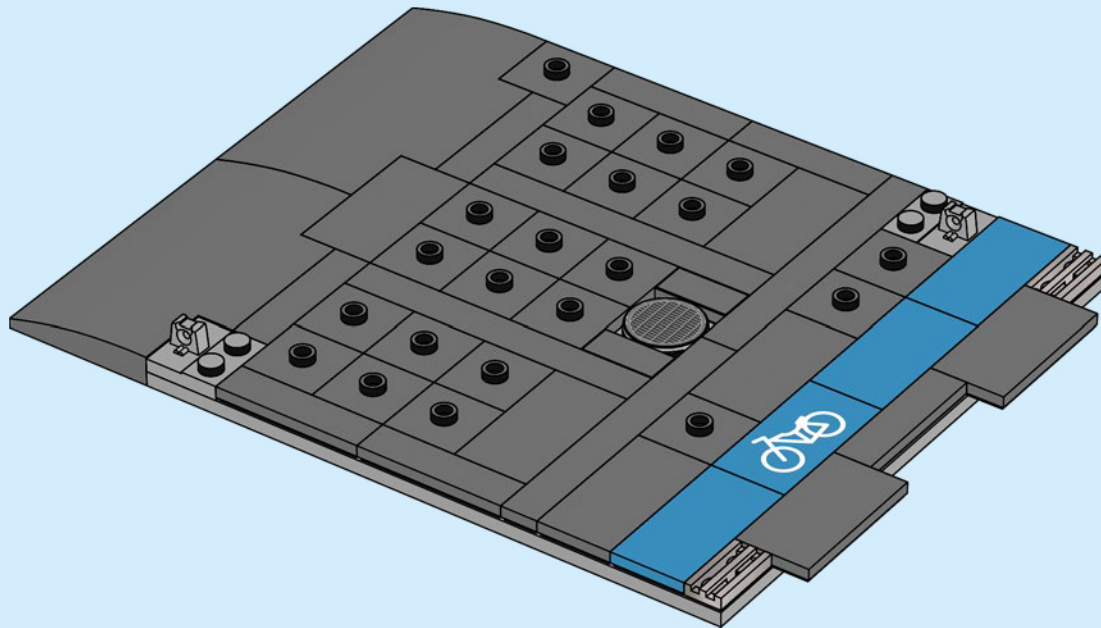

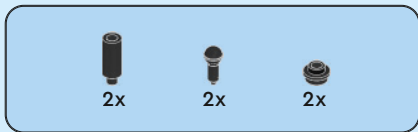

49

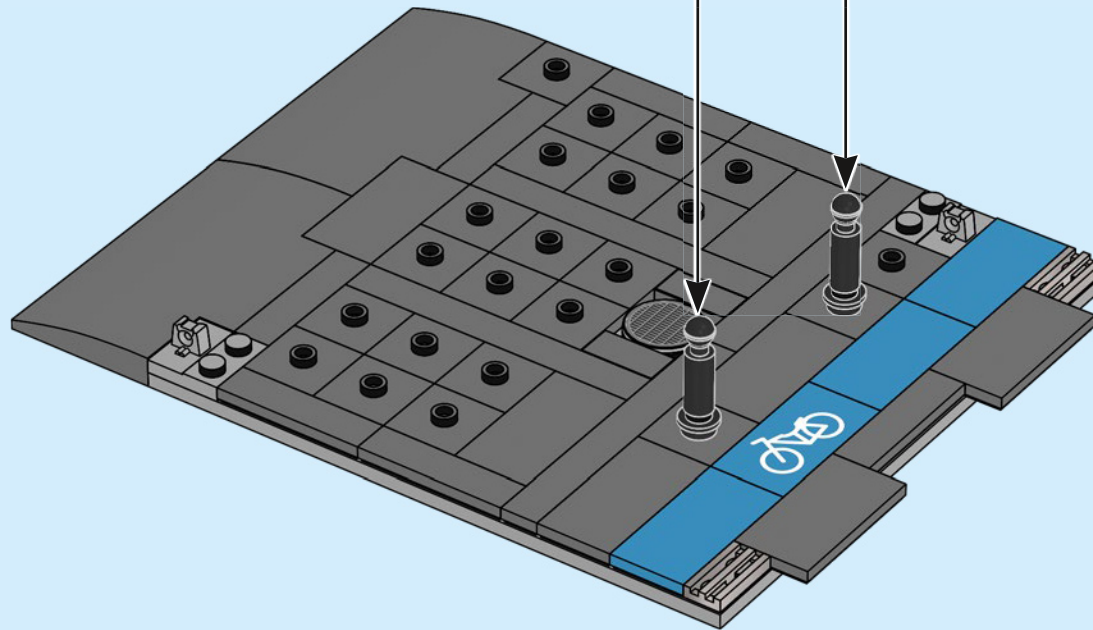
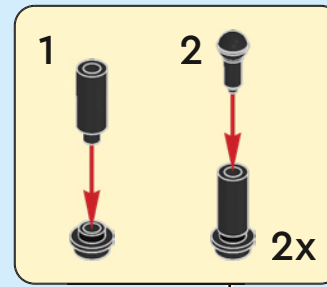

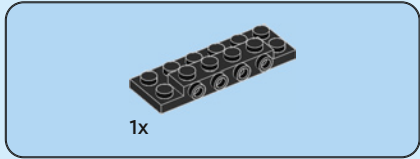

50

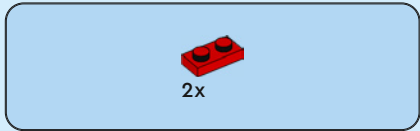
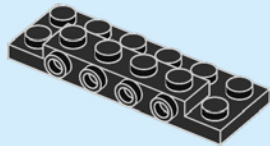

51

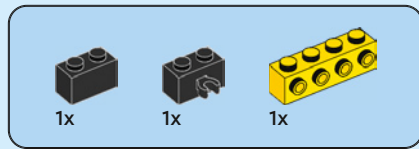
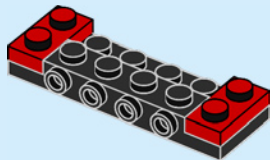

52

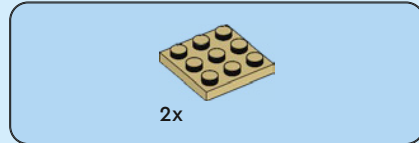
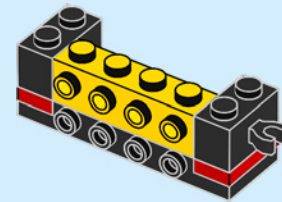

53

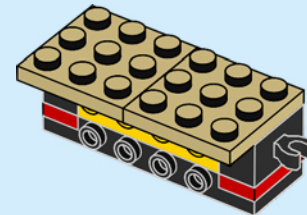

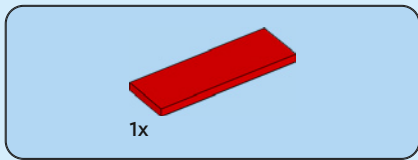

54

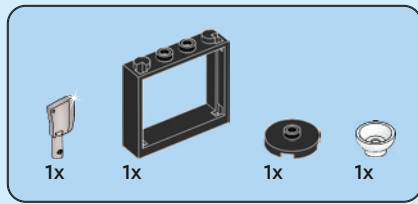
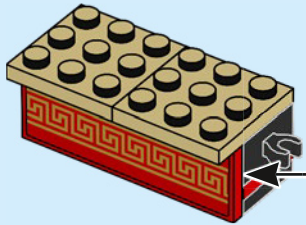
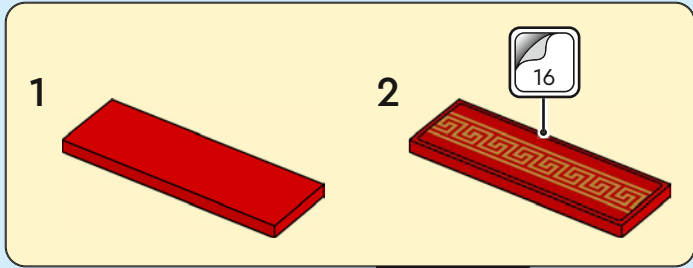

55

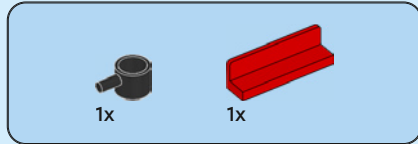
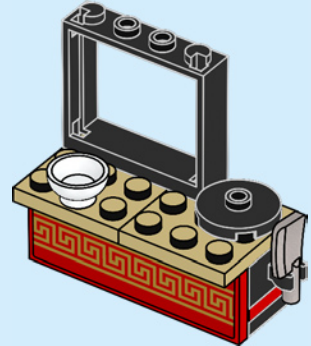

56

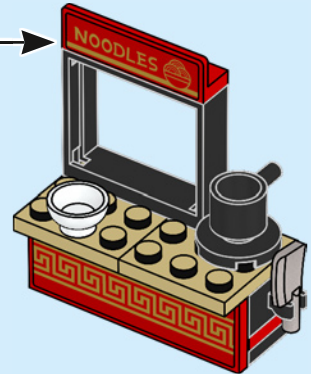
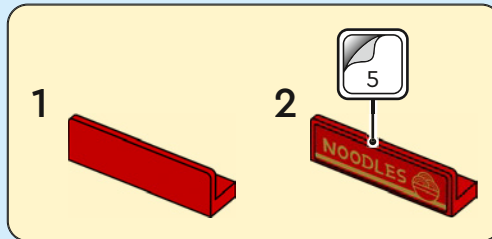



57

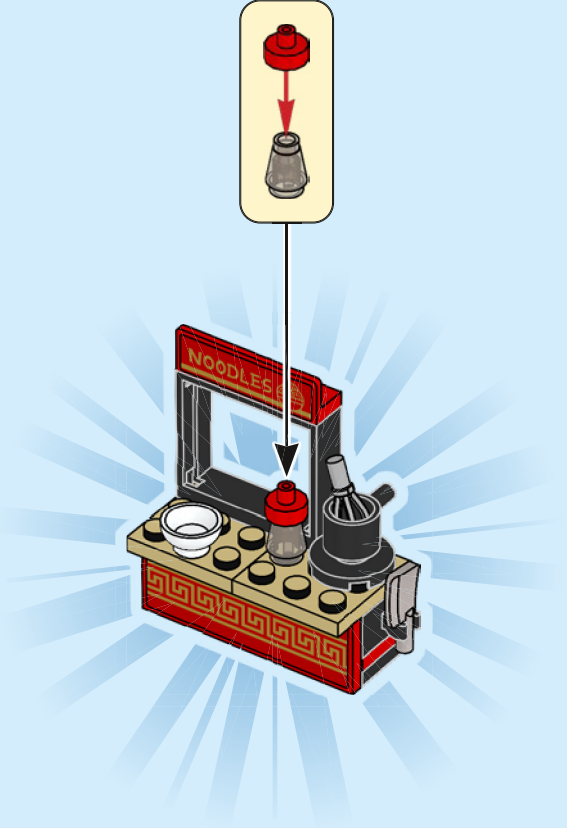

58

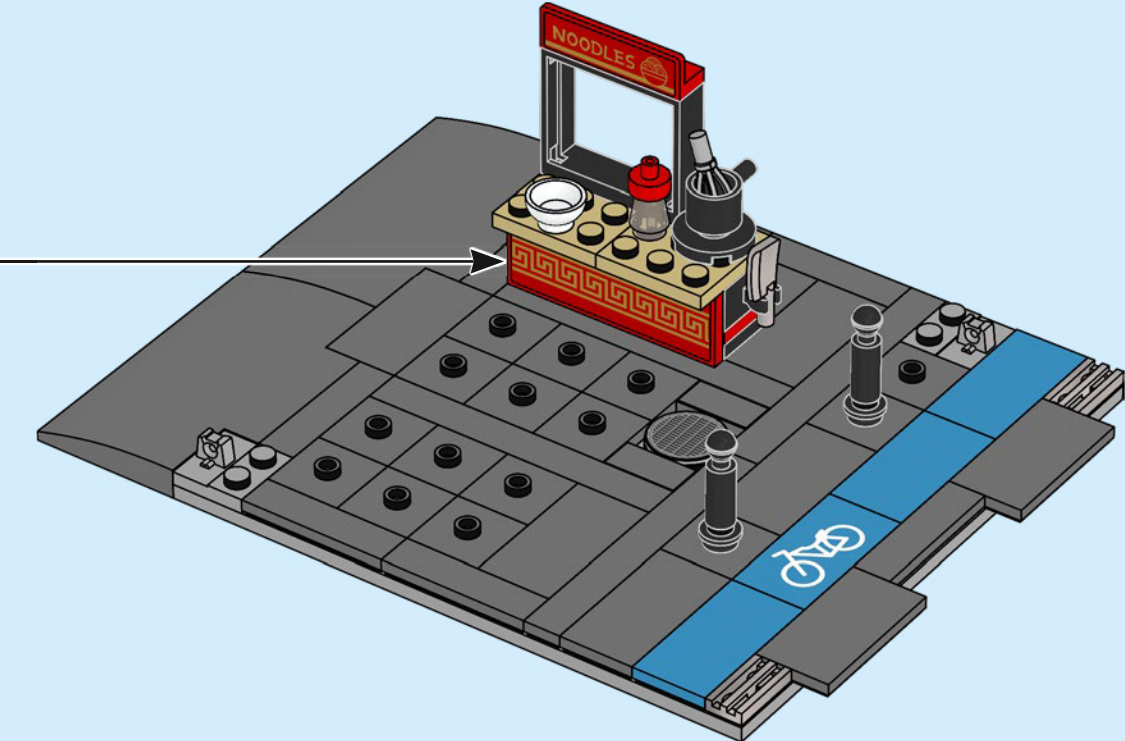

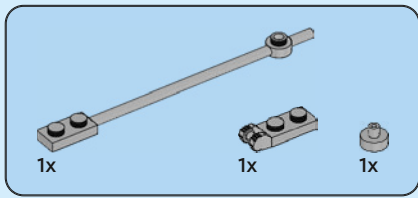

59

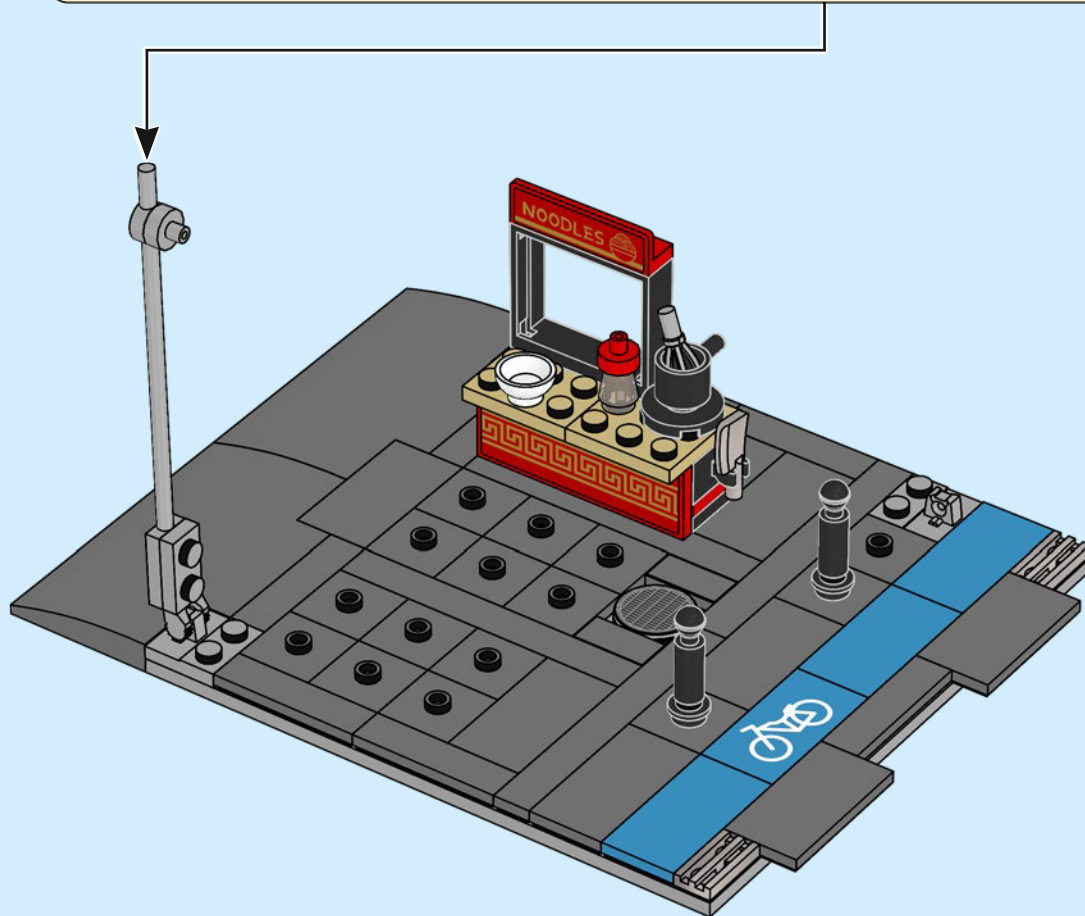
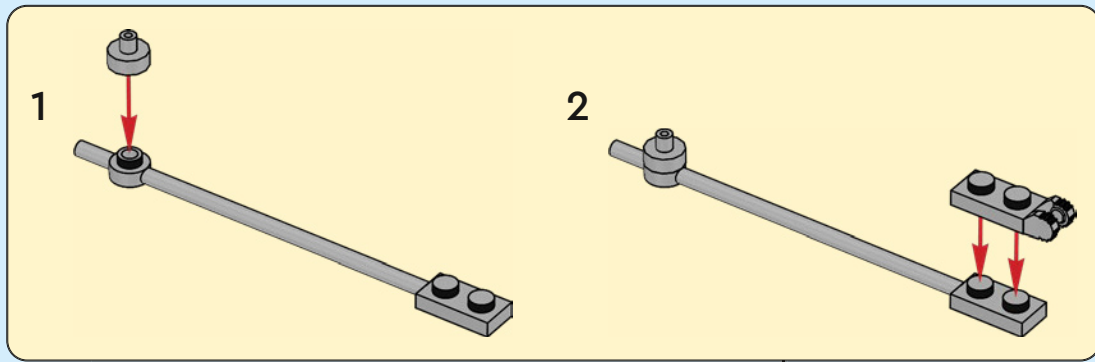

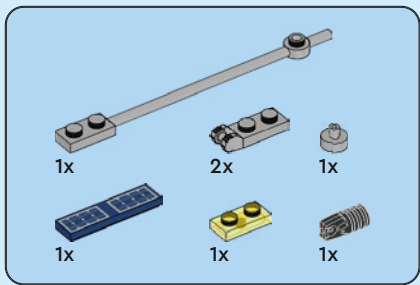

60

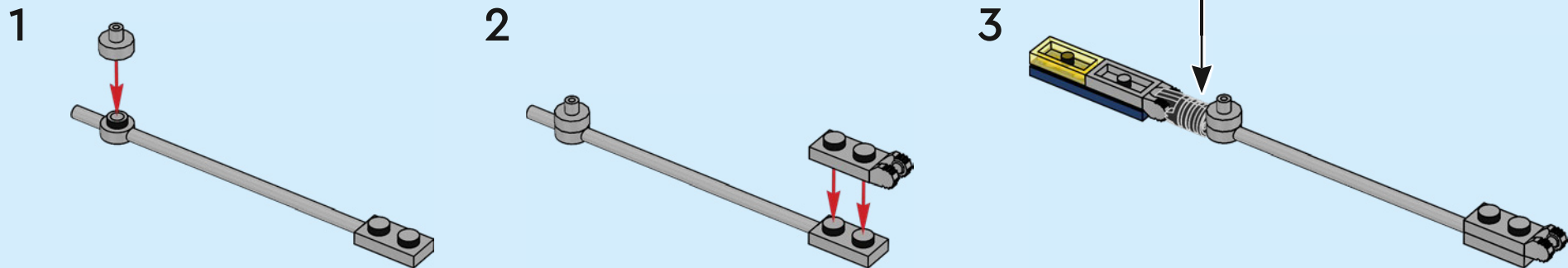
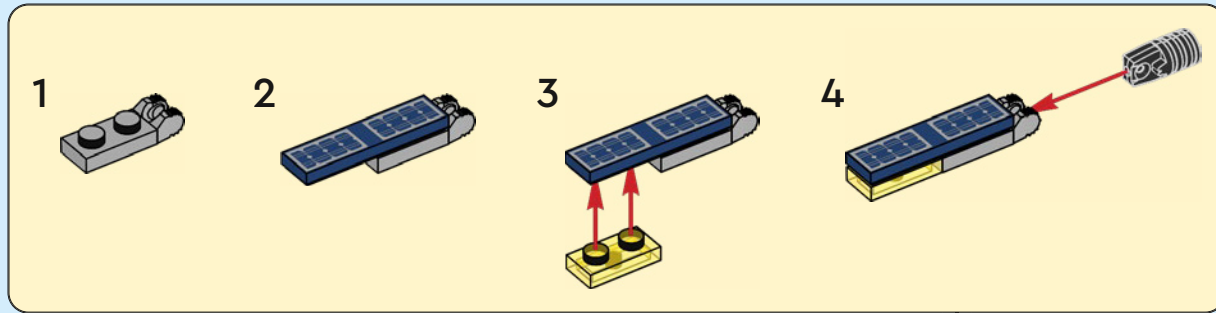

4

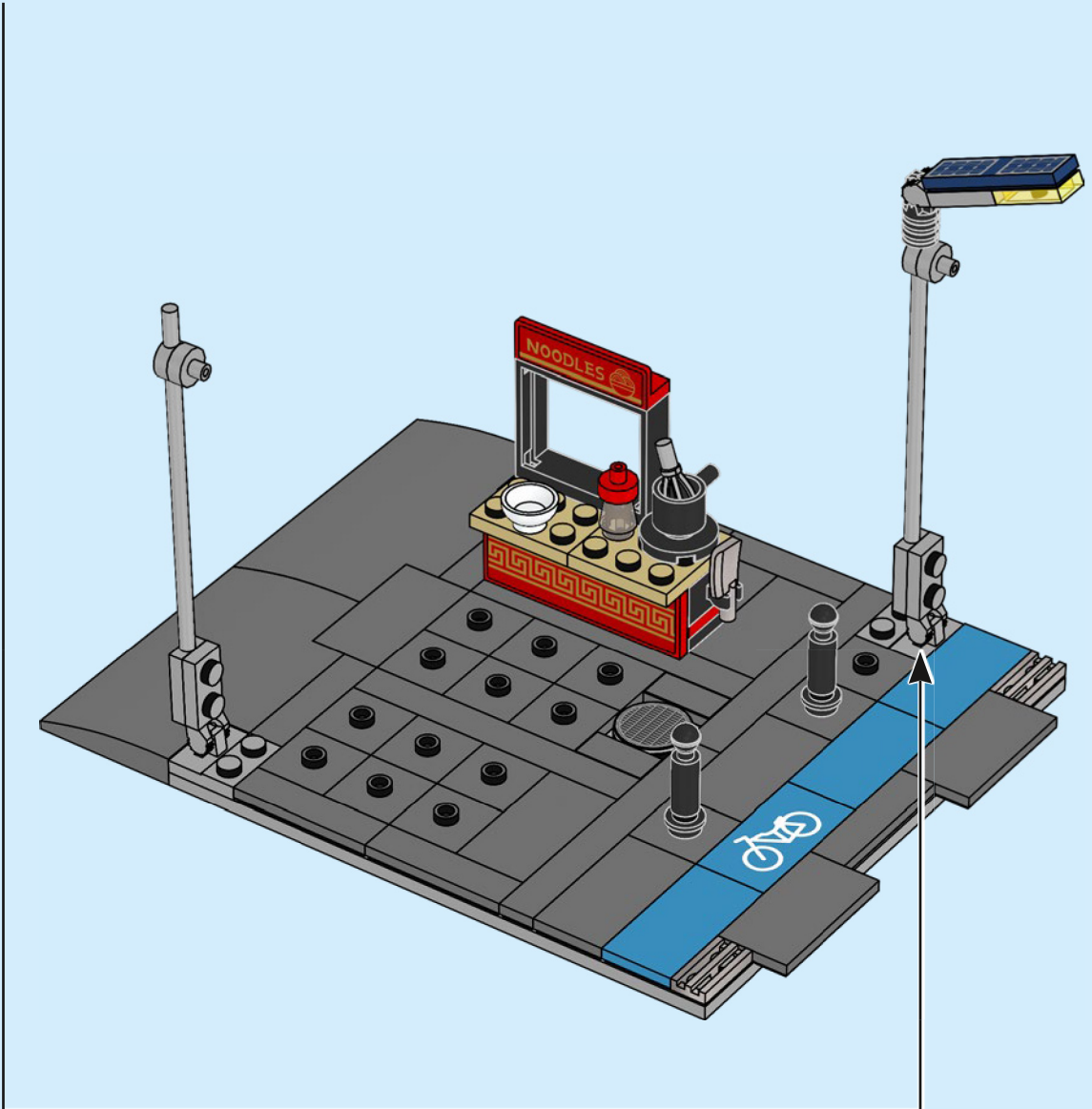
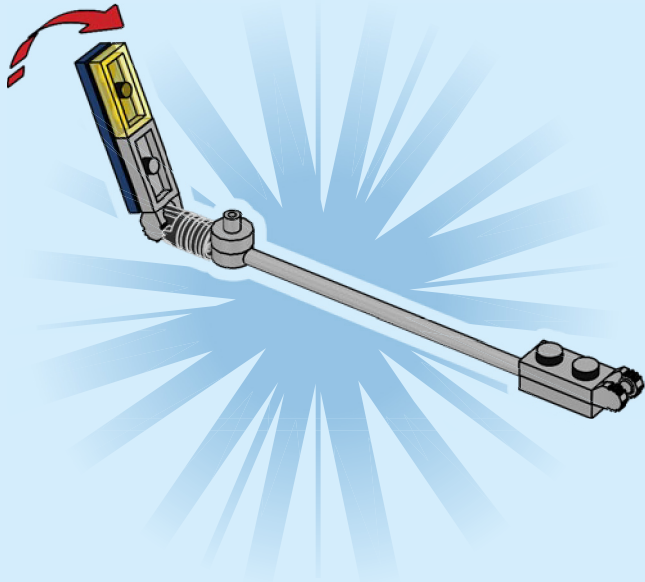

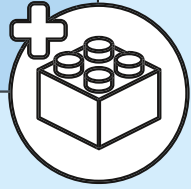
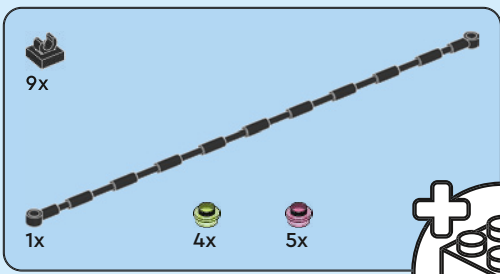

61

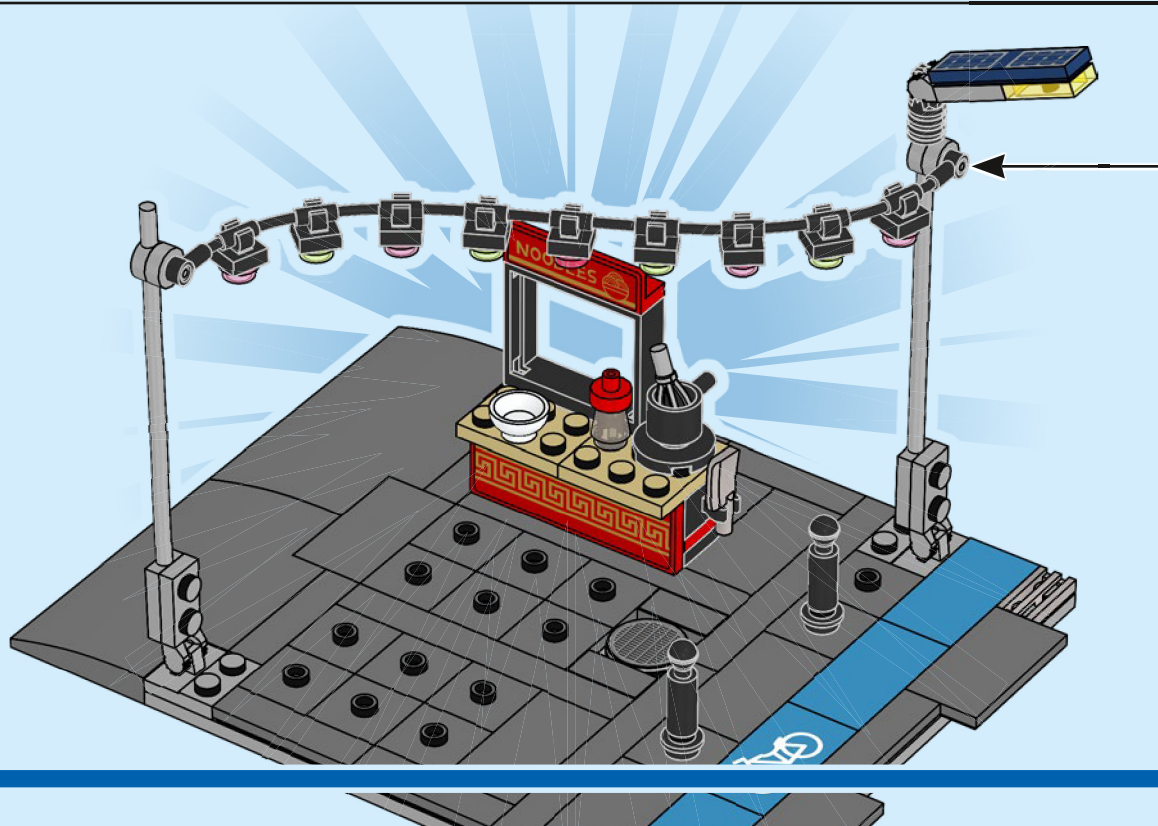
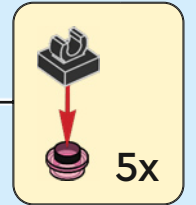
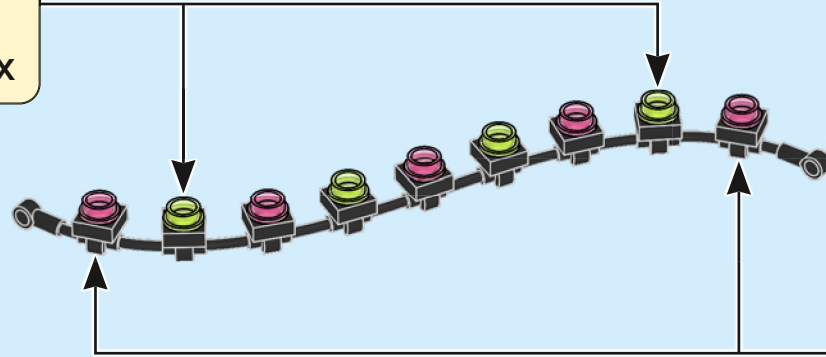
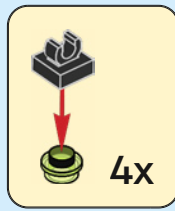

62



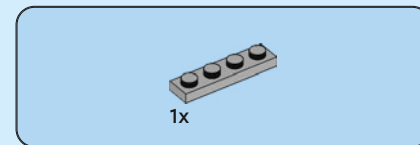
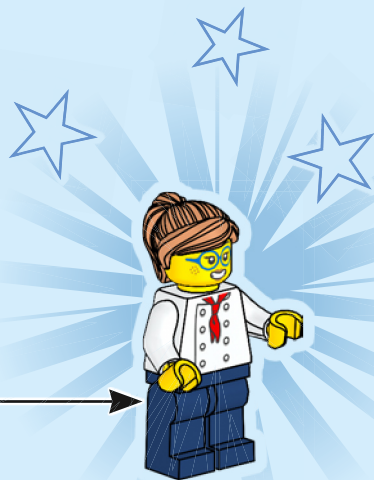
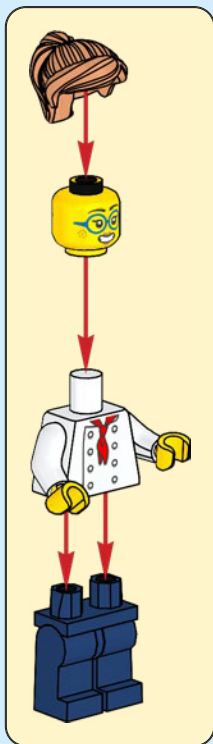
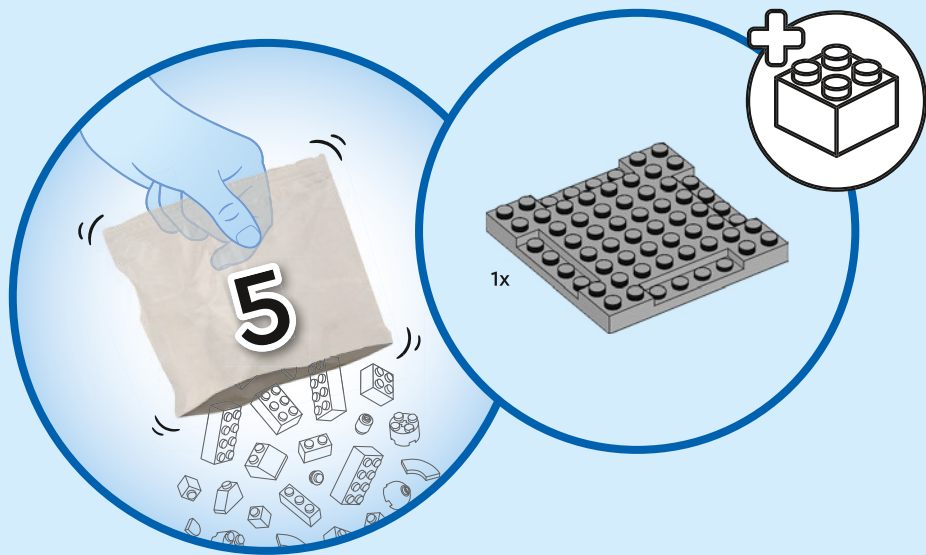

63

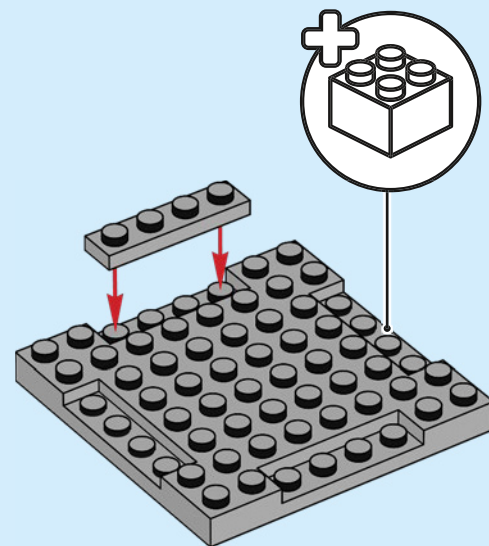

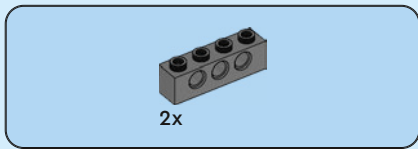

64

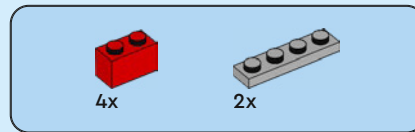
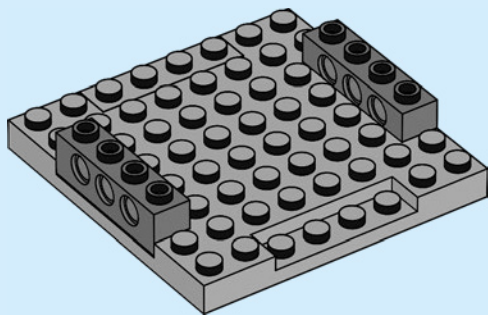

65

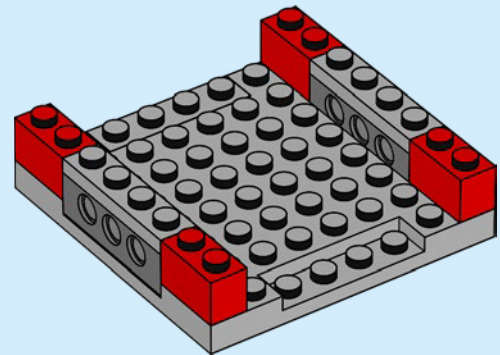



2x

66

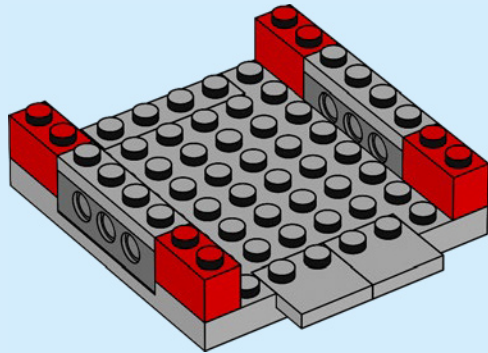

6x

67

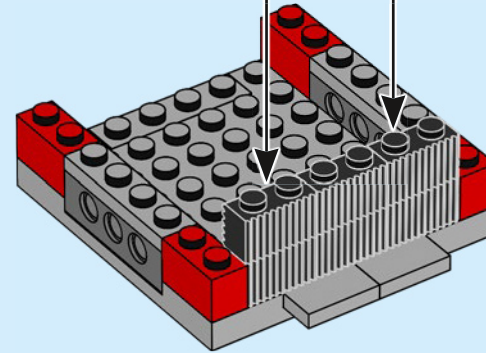
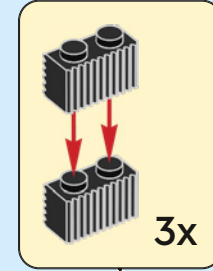

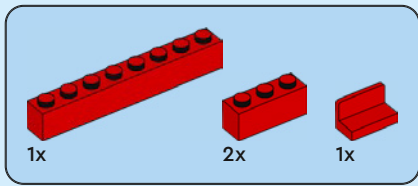

68

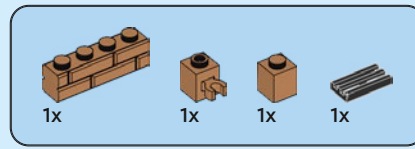
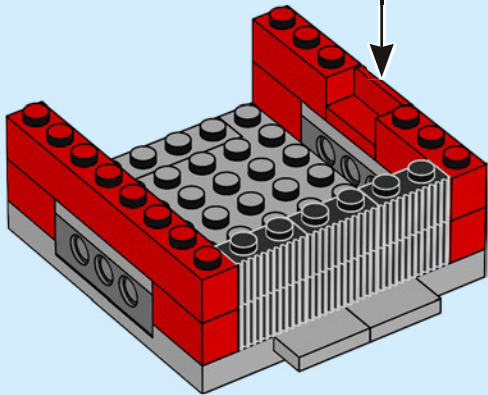
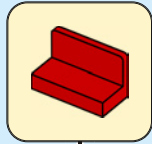

69

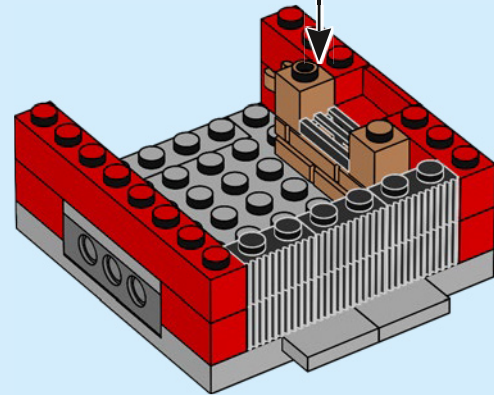
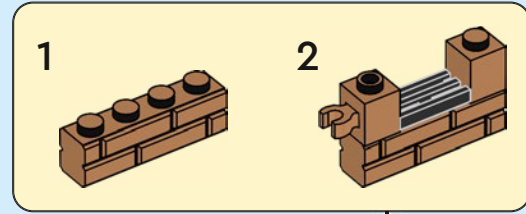

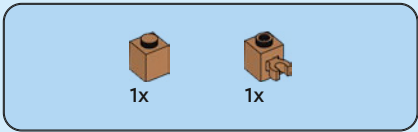

70

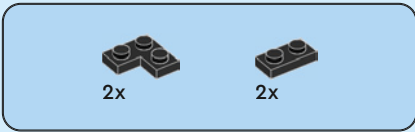
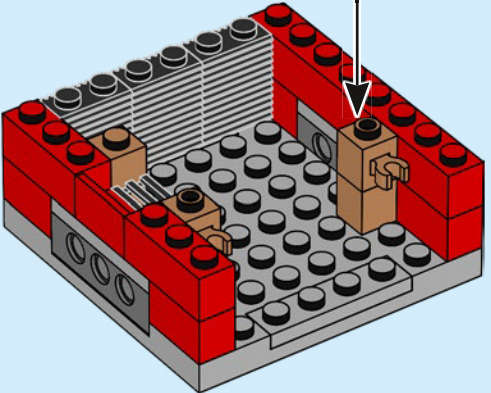
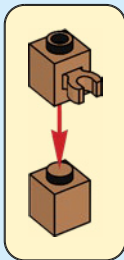

71

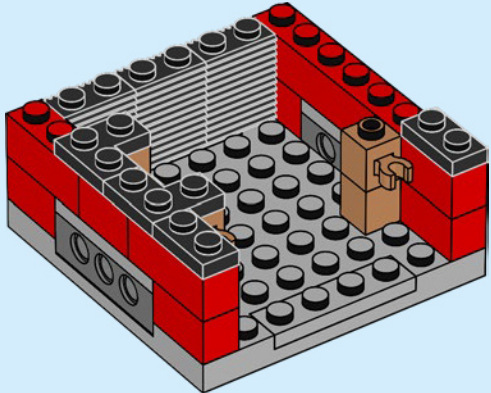

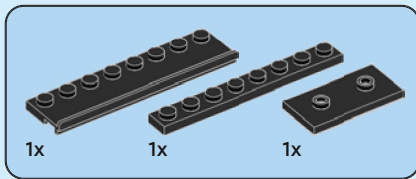

72

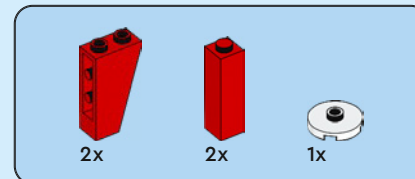
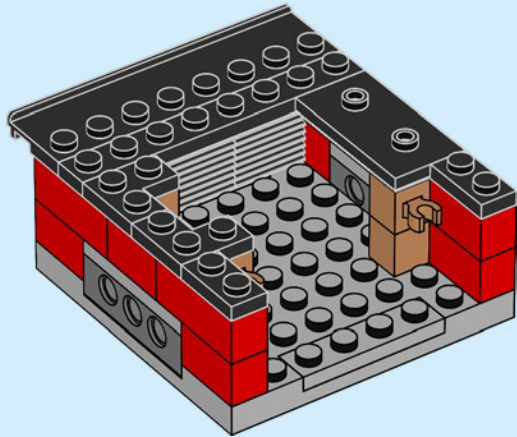

73

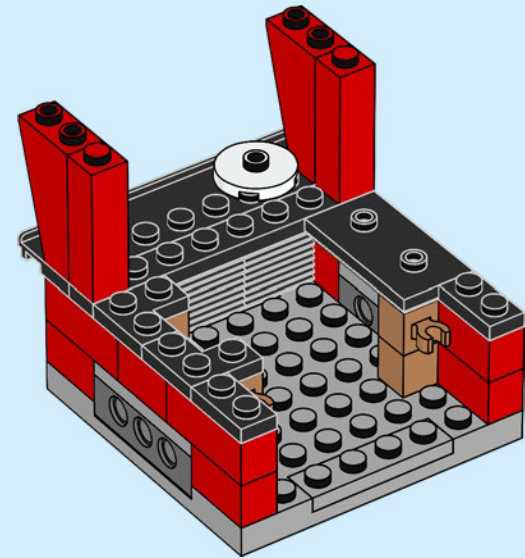



74

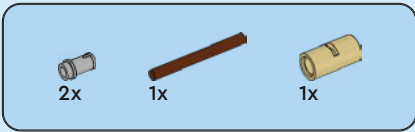
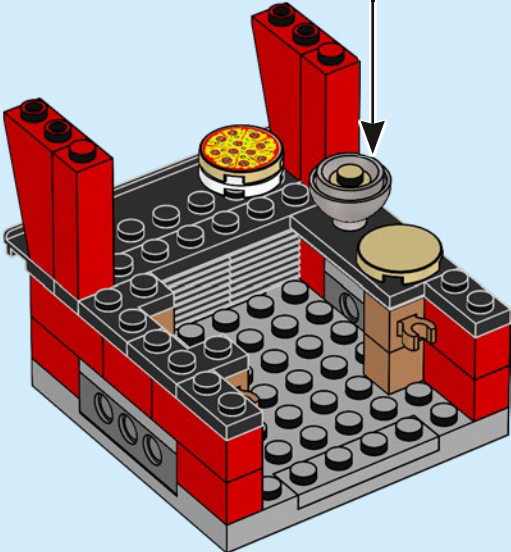
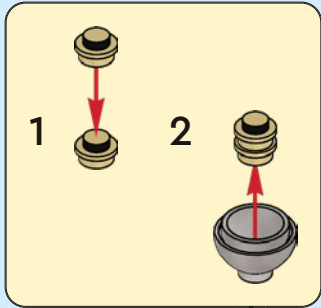

75

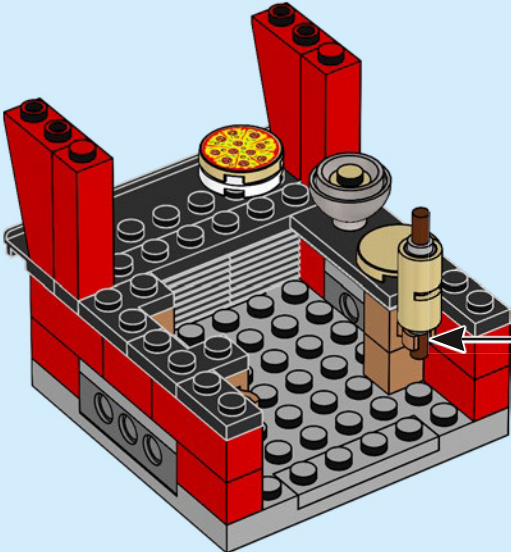
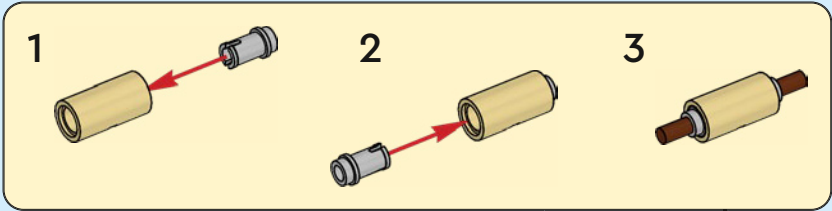

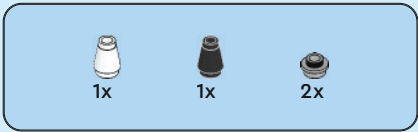

76

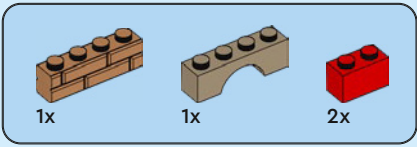
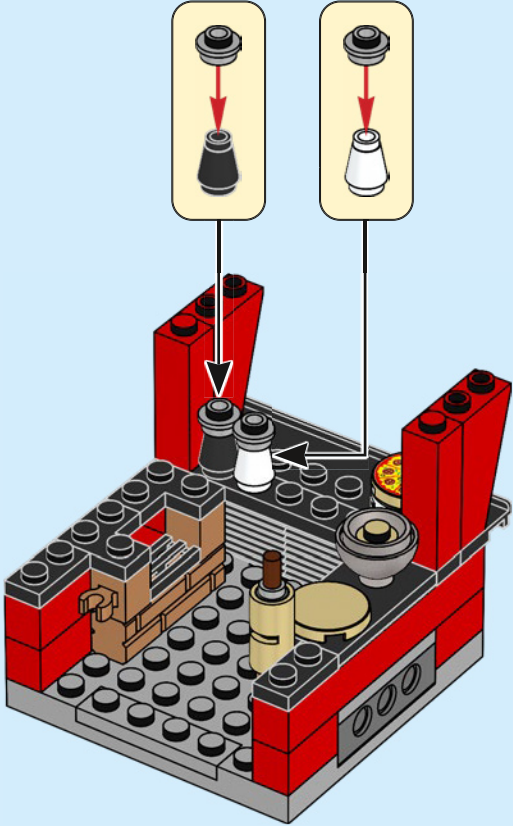

77

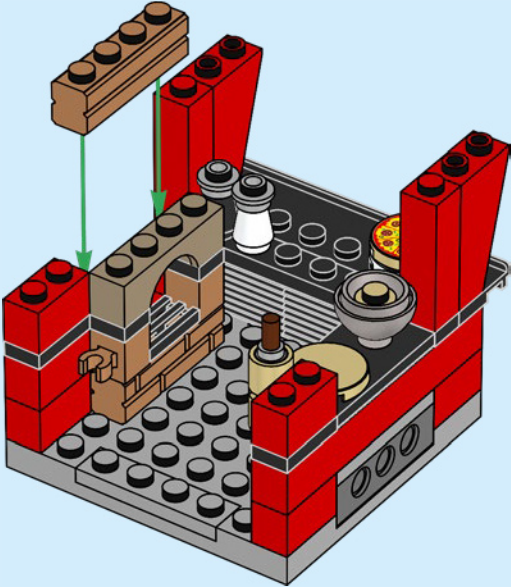

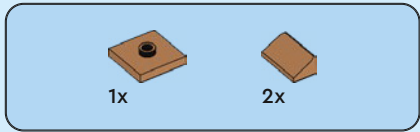

78

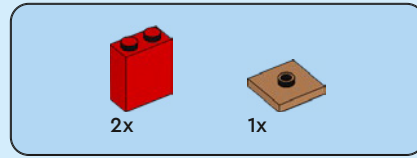
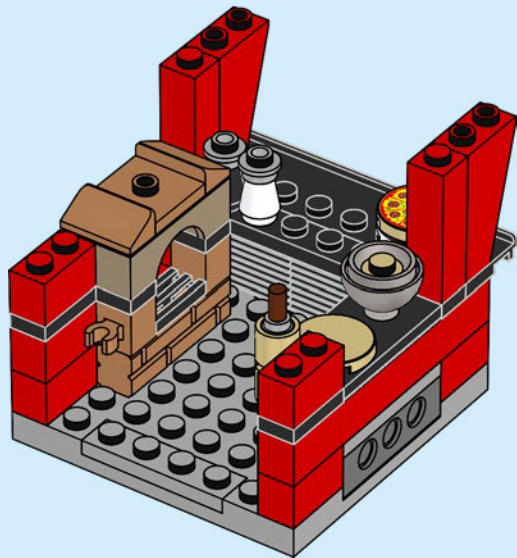

79

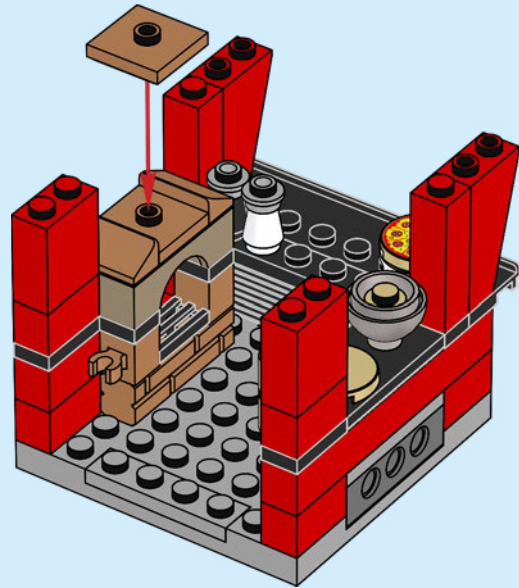

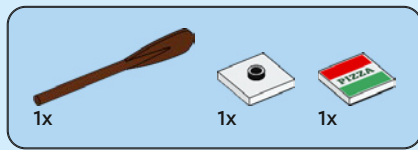

80

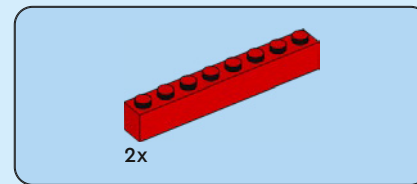
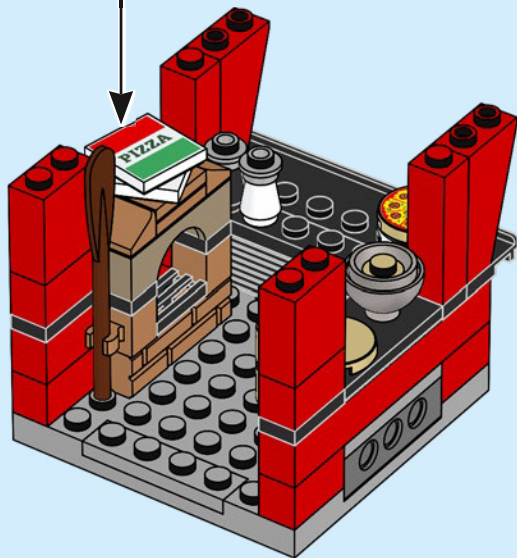
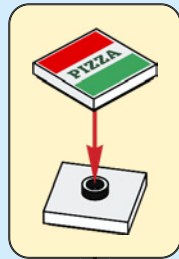

81

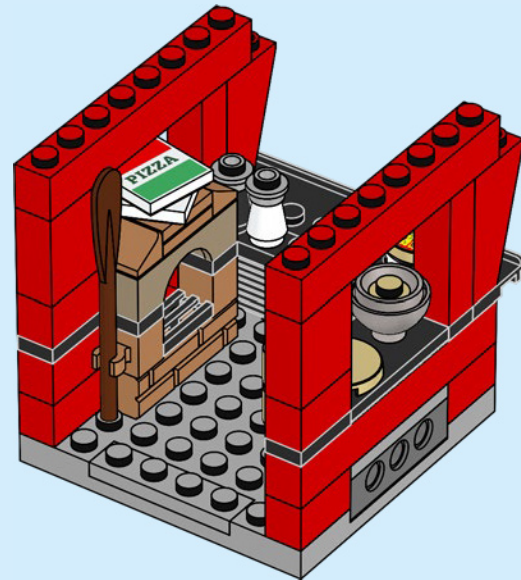

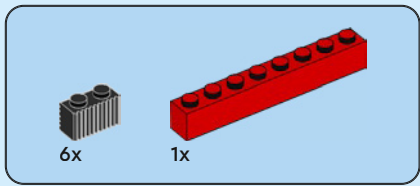

82

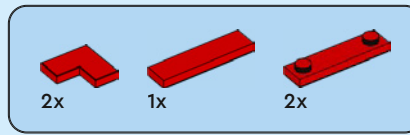
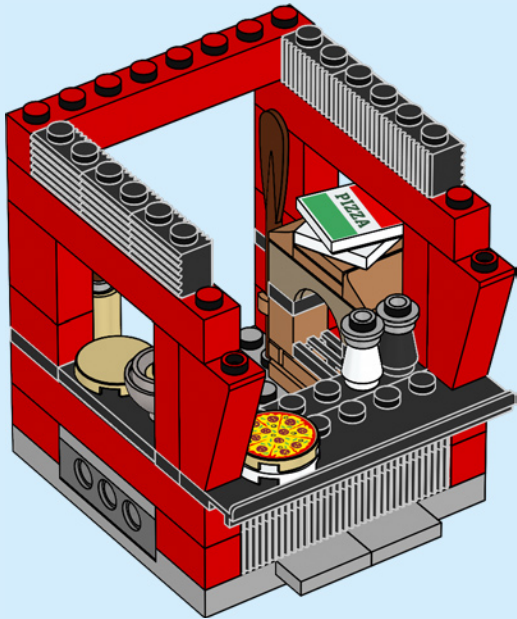

83

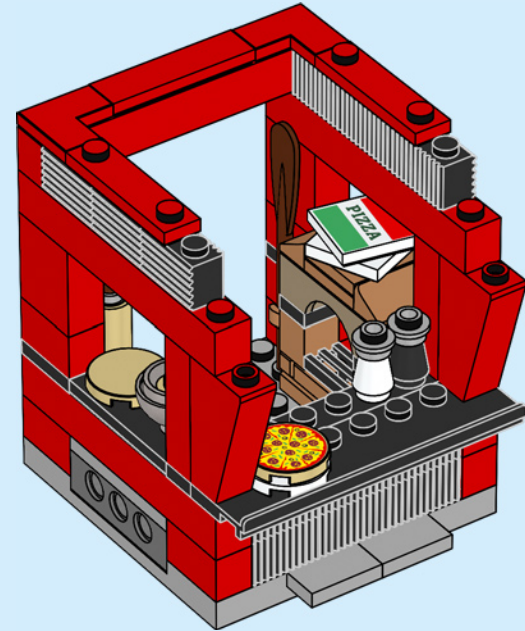

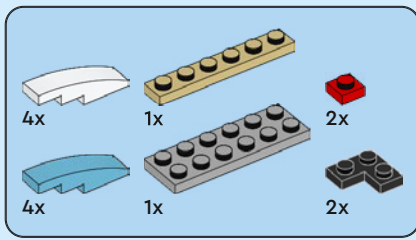

84

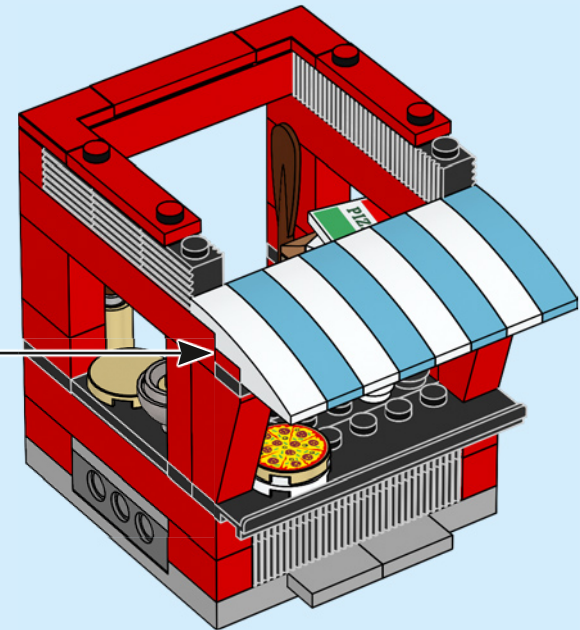
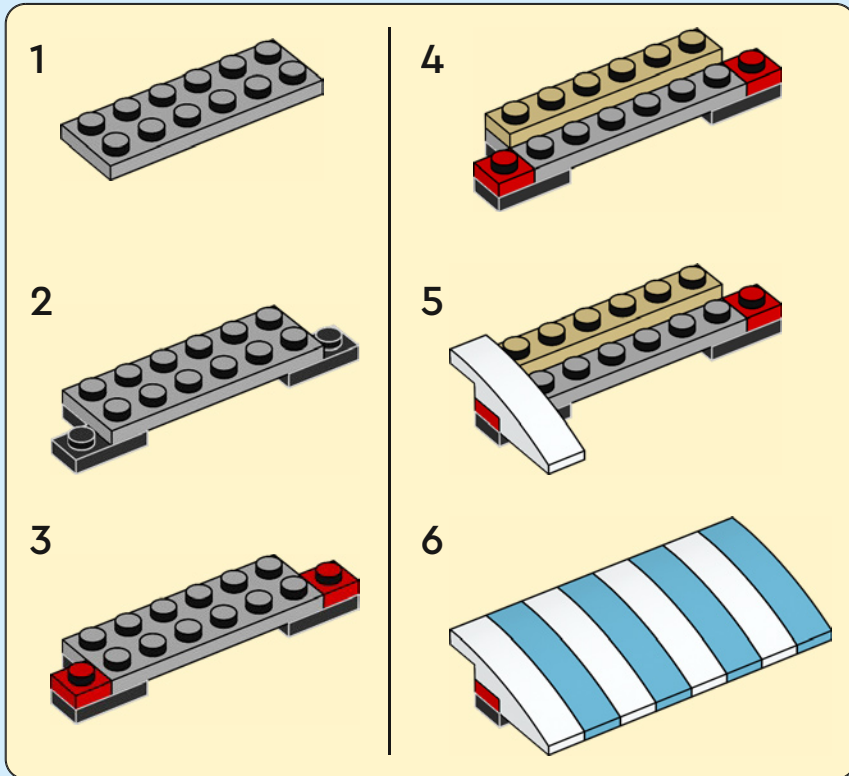

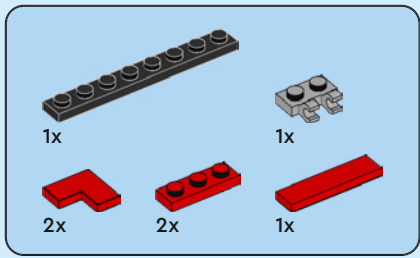

85

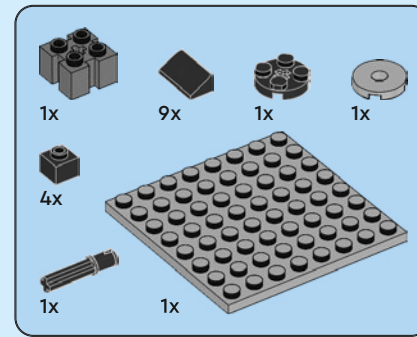
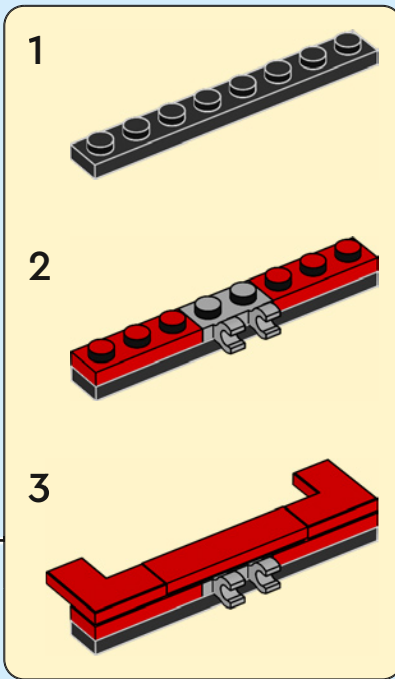
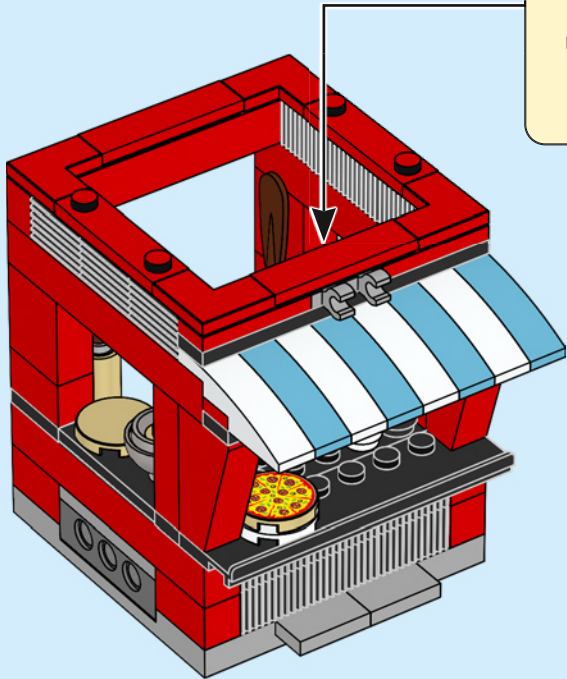

86

1

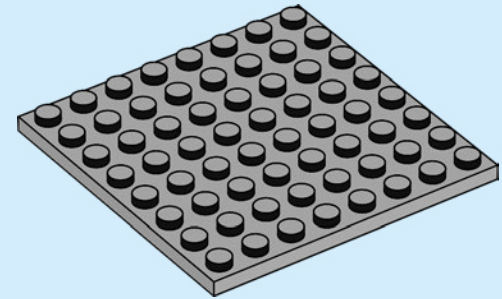

2

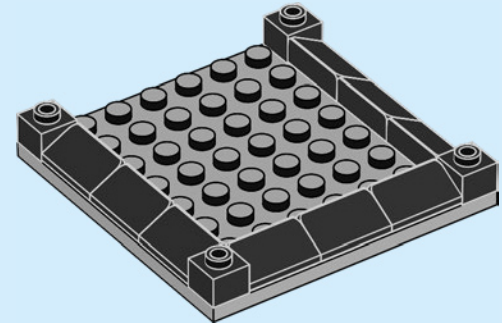

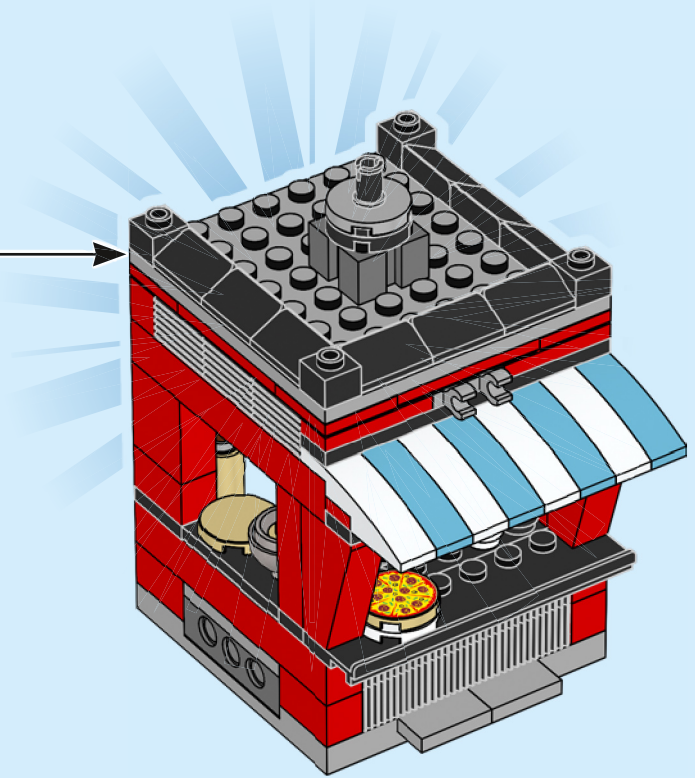
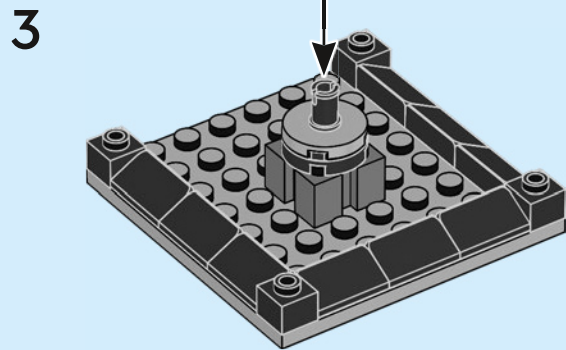
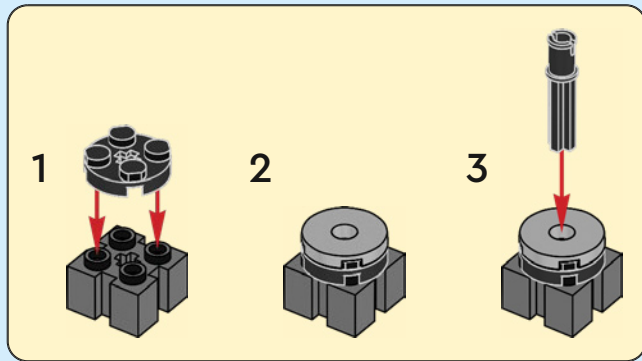

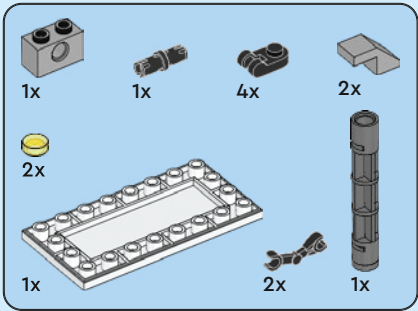

87

1

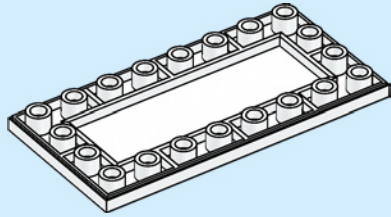

2

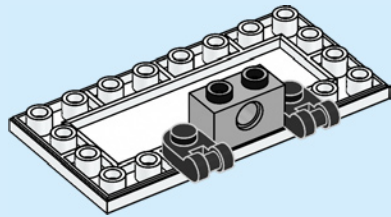

3

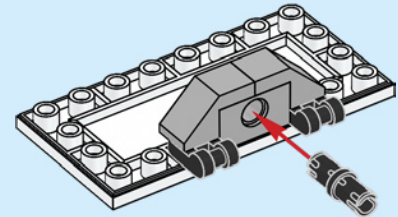

4

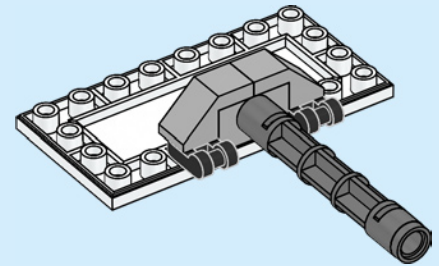



5

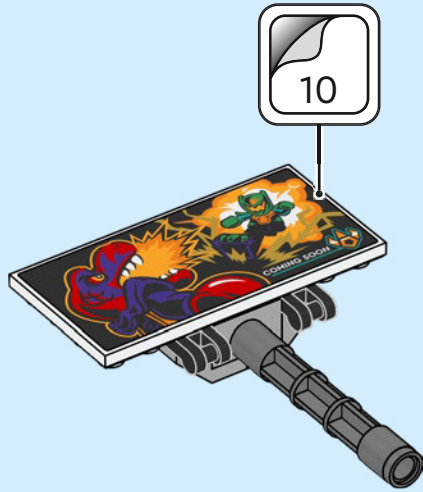

6

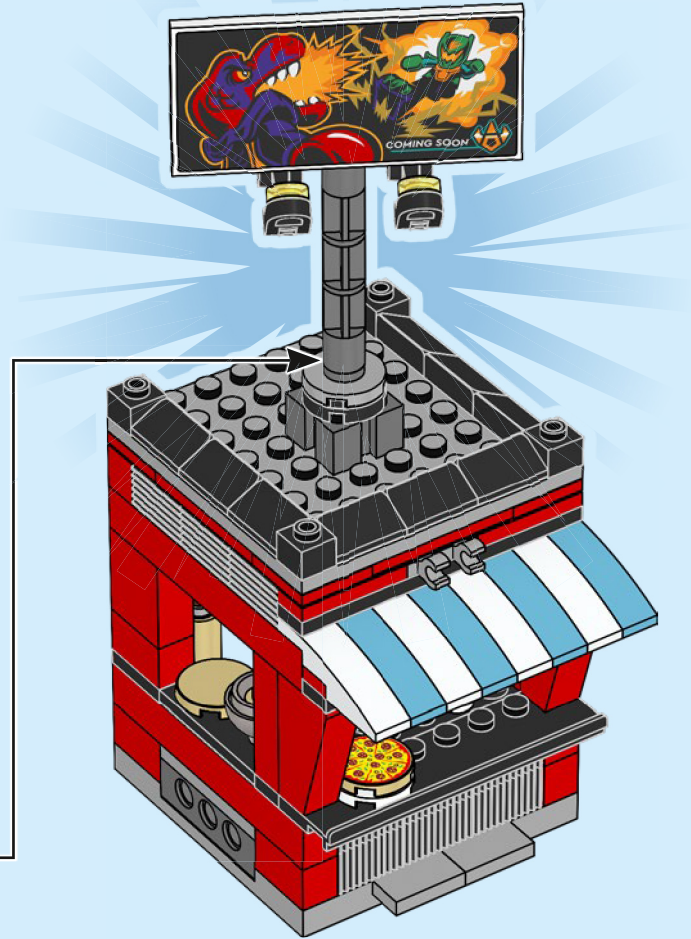
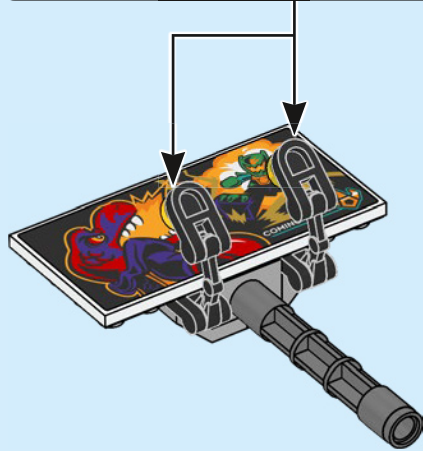

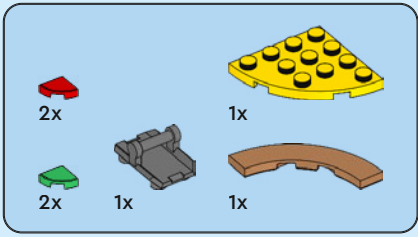

88

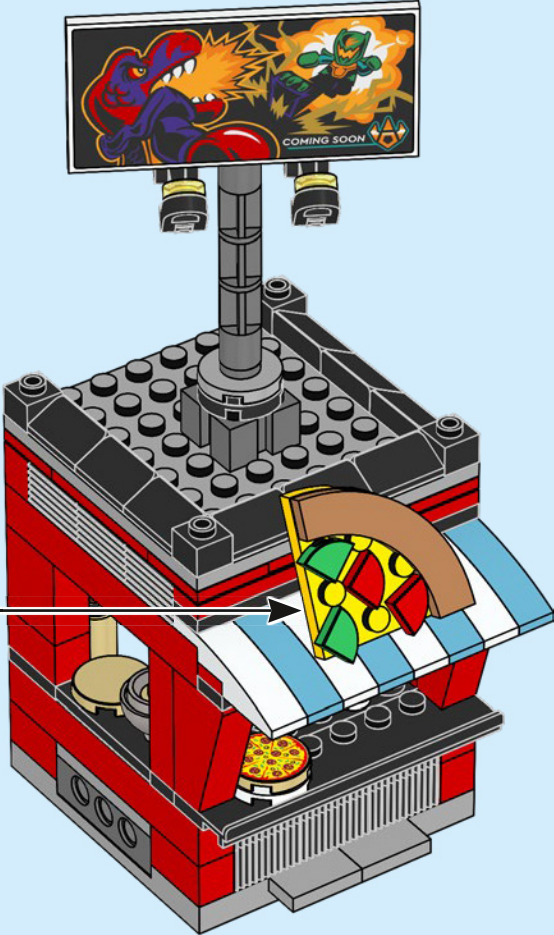
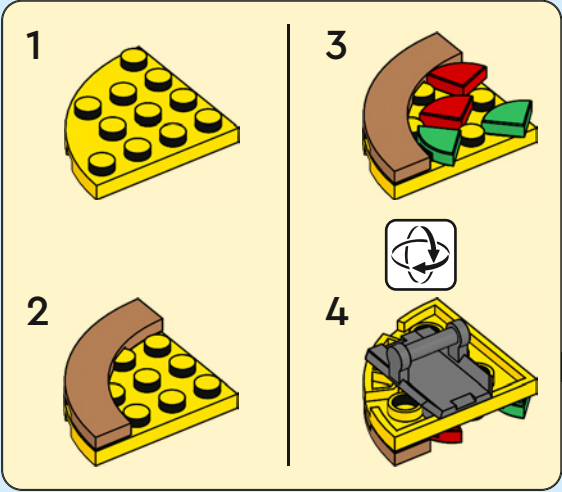

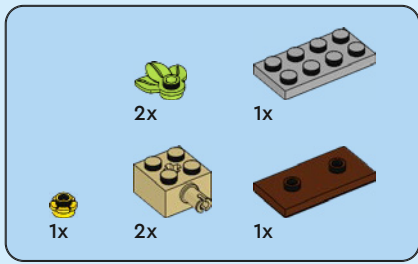

89

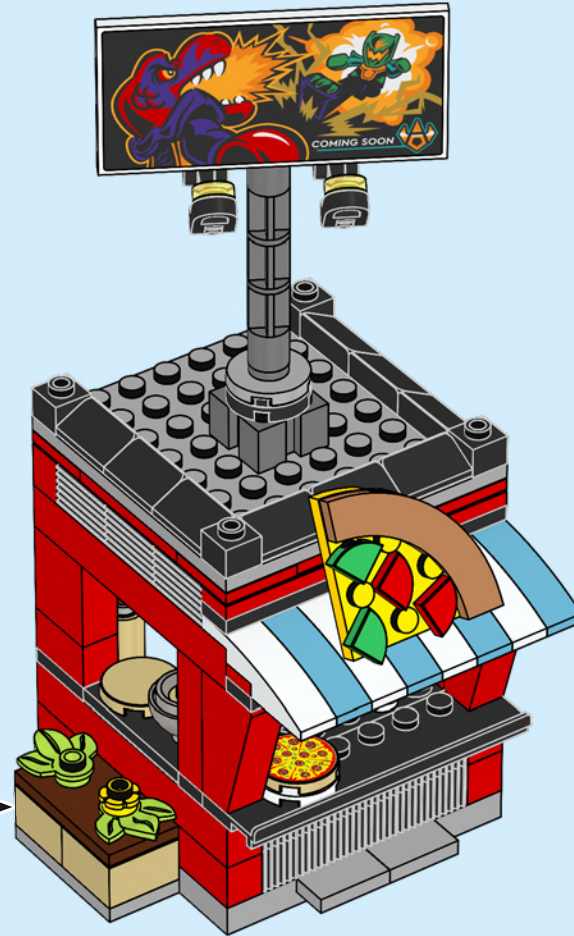
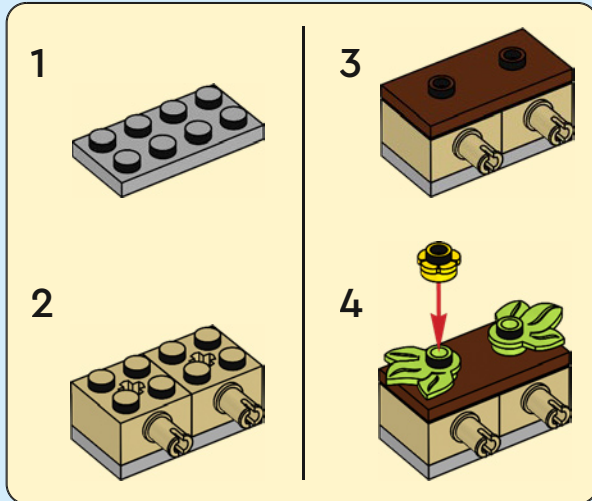

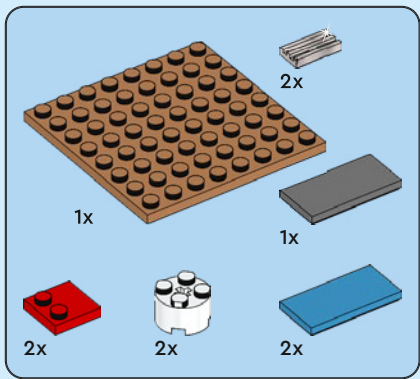

90

1

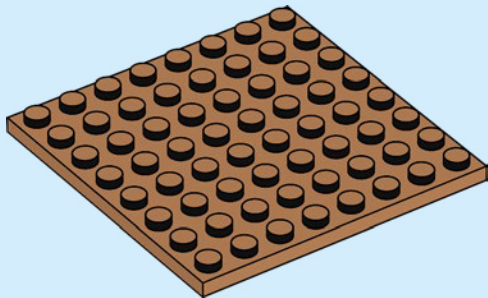

2

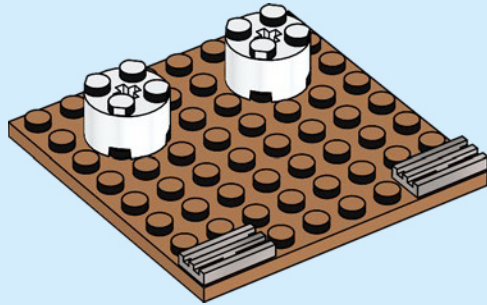

3

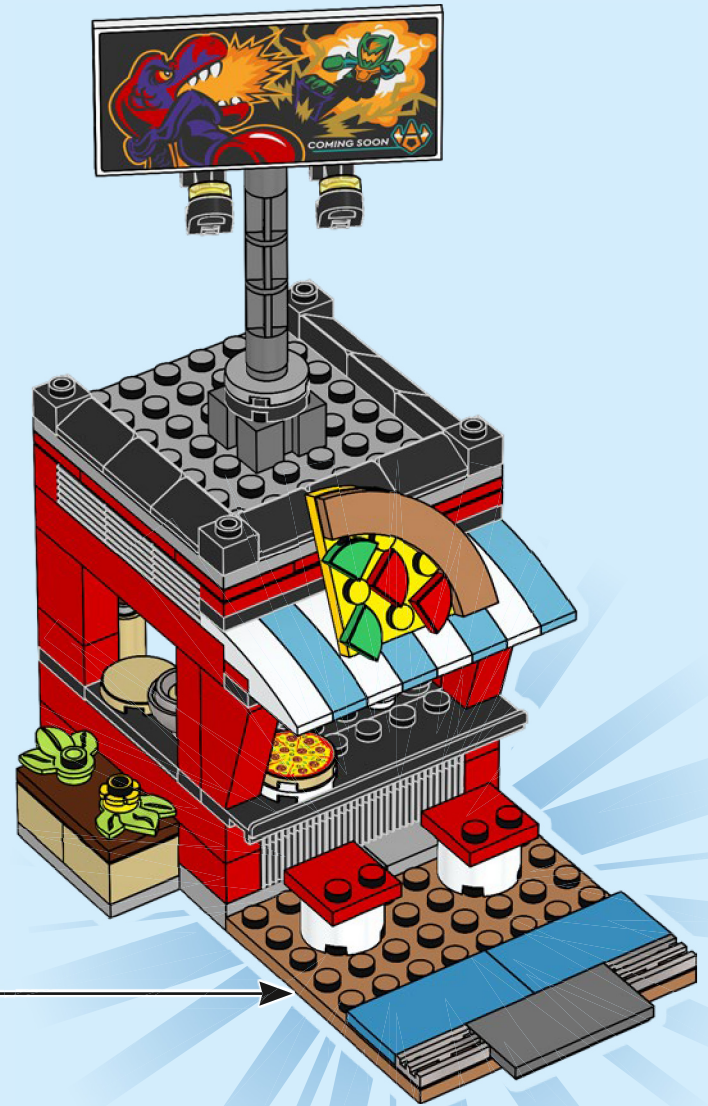
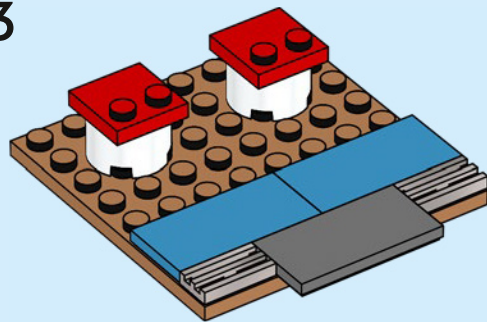

91

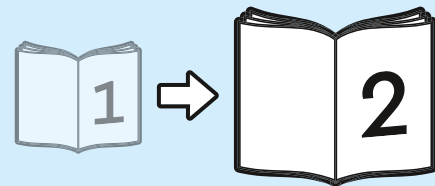
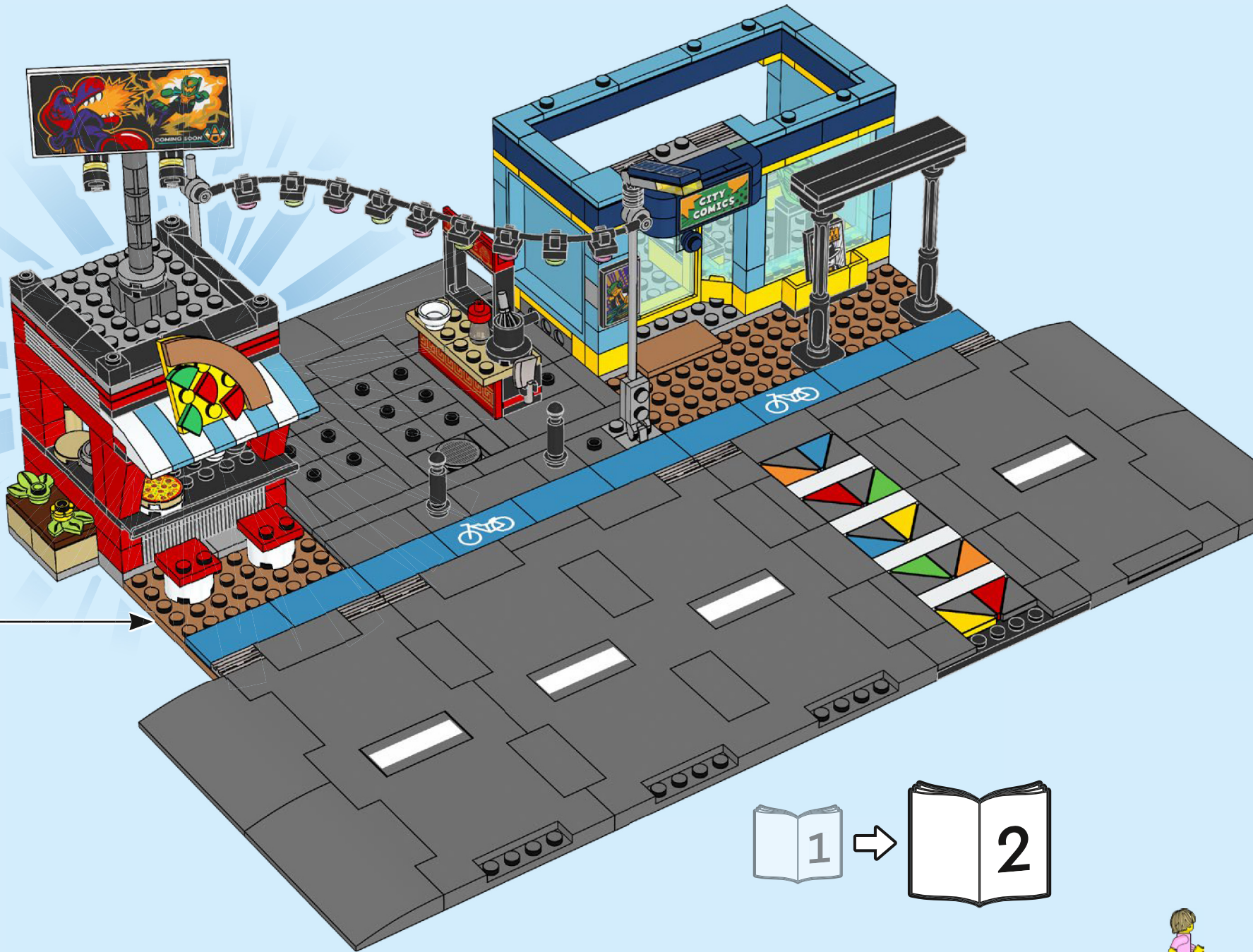

YOU COULD **WIN** 



Scan this QR code or go to **LEGO.COM/PRODUCTFEEDBACK** and give us your short feedback about this LEGO® set for a chance to win a cool LEGO prize.

Terms and Conditions apply*

EN: YOU COULD WIN. Terms and Conditions apply* **DE: Du könntest GEWINNEN.** Es gelten die Teilnahmebedingungen* **FR: Tu pourrais GAGNER.** Des conditions s'appliquent* **IT: Potresti VINCERE tu.** Termini e condizioni sono applicabili* **ES: Puedes GANAR.** Aplican términos y condiciones* **PT: Poderá GANHAR.** Aplicam-se termos e condições* **ZH: 轻松获奖. 条款和条件适用*** **PL: Szansa na WYGRANĄ.** Obowiązują warunki korzystania* **CS: Máte šanci VYHRÁT.** Platí všeobecné smluvní podmínky* **SK: Máte šancu VYHRAŤ.** Platia všeobecné zmluvné podmienky* **HU: TE IS NYERHETSZ.** Felhasználási feltételek érvényesek* **RO: Ai putea CÂȘTIGA.** Se aplică termenii și condițiile* **BG: Можете да СПЕЧЕЛИТЕ.** Има определени правила и условия* **LV: Tu vari LAIMĒT.** Ir spēkā noteikumi un nosacījumi.* **ET: Sul on võimalus VÕITA.** Kehtivad tingimused* **LT: Jūs galite LAIMĖTI.** Taikomos sąlygos*

*[LEGO.com/productfeedback-terms](https://www.lego.com/productfeedback-terms)