



76959





[LEGO.com/sustainable-packaging](https://www.lego.com/sustainable-packaging)

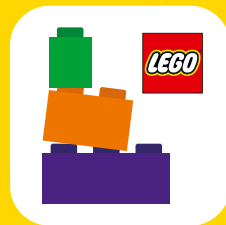

# BUILDER



Apple and the Apple logo are trademarks of Apple Inc., registered in the U.S. and other countries and regions. App Store is a service mark of Apple Inc. Google Play and the Google Play logo are trademarks of Google LLC. Tencent and the Tencent logo are trademarks of Tencent Inc.

Q [LEGO.com/devicecheck](https://www.lego.com/devicecheck)

**EN** Ask parents' permission before going online | **DE** Eltern um Erlaubnis bitten, bevor du online gehst | **FR** Demande l'autorisation d'un parent avant d'aller en ligne | **IT** Chiedi il permesso ai tuoi genitori prima di andare online | **ES** Pídeles permiso a tus papás antes de conectarte a Internet | **PT** Pede autorização aos pais antes de acederes online | **ZH** 上网前应先征得父母的同意 | **PL** Poproś rodziców o zgodę, zanim wejdiesz do Internetu | **CS** Než půjdeš na internet, požádej rodiče o svolení | **SK** Skôr než pôjdeš na internet, vypýtaj si povolenie od rodičov | **HU** Kérj szülői engedélyt, mielőtt online csatlakoznál! | **RO** Cere permisiunea părinților înainte de a te conecta online | **BG** Поискайте разрешение от родител, преди да влезете онлайн | **LV** Pirms došanās tiešsaistē palūdz atļauju vecākiem | **ET** Enne Interneti kasutamist küsi vanematelt luba | **LT** Prieš prisijungdami prie interneto, atsiklauskite tėvų

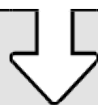
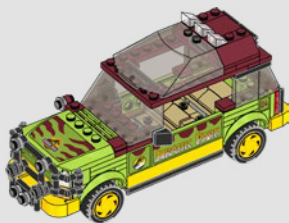
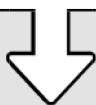
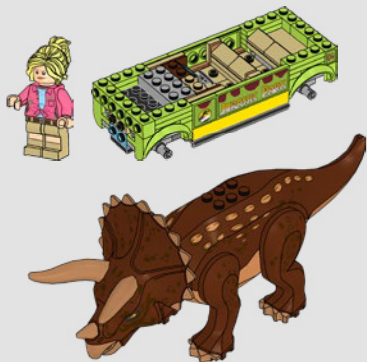
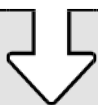

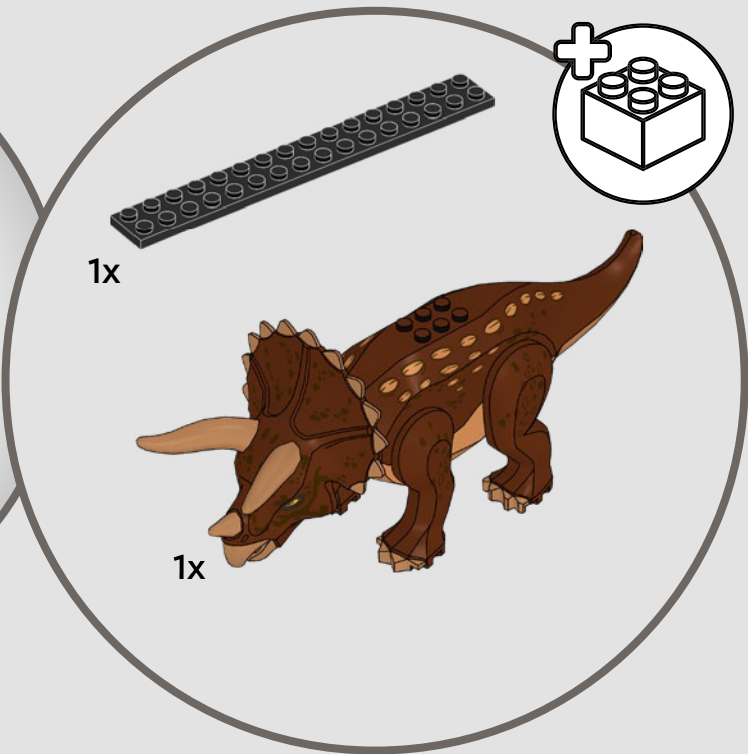

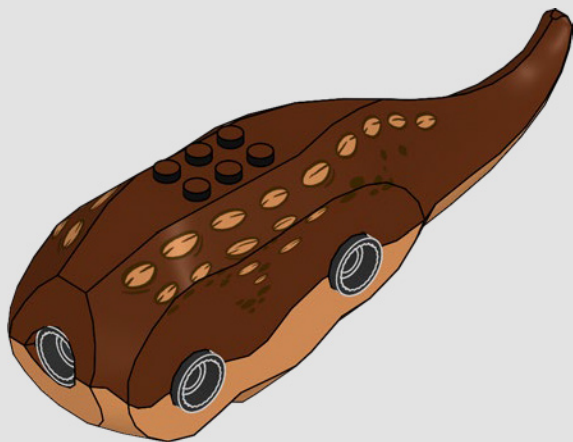
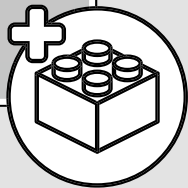
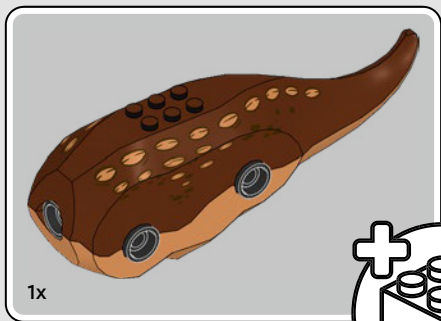
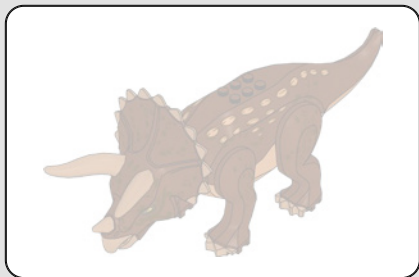

1

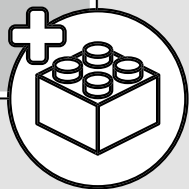
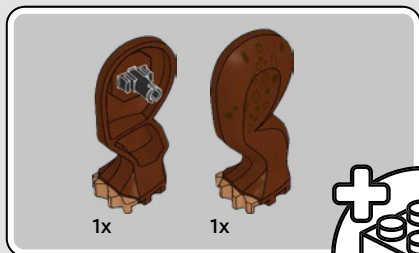

2

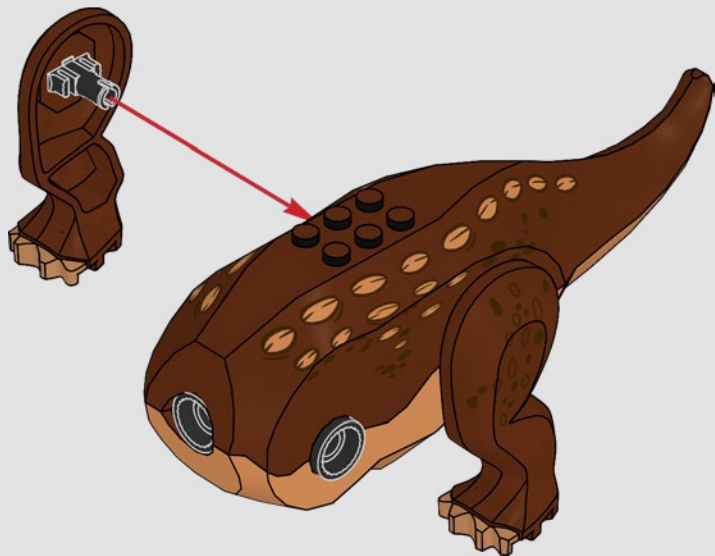

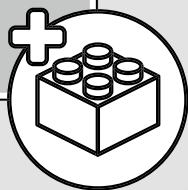

3

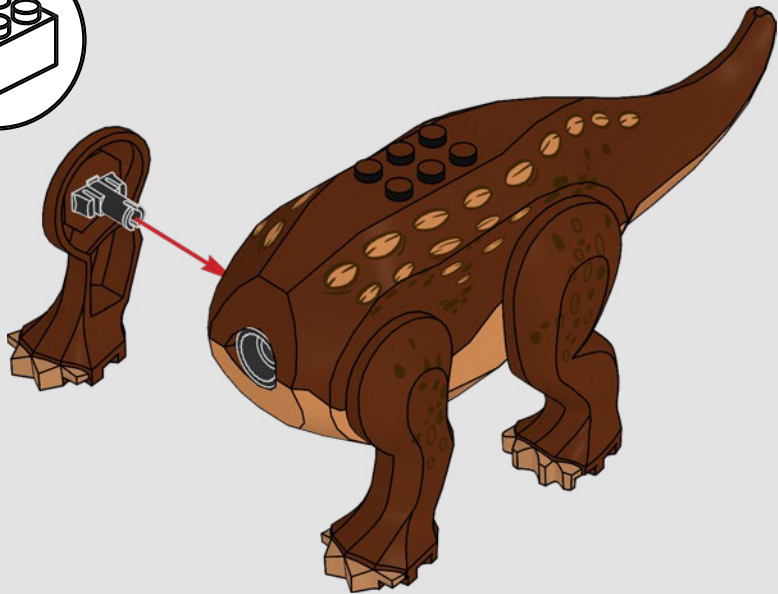



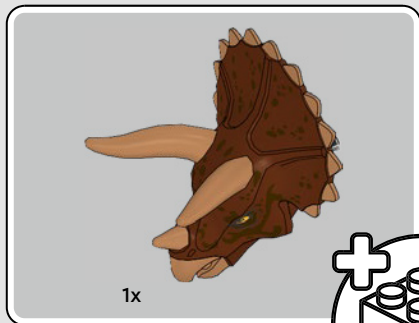

4



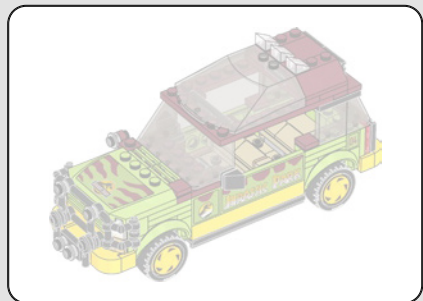
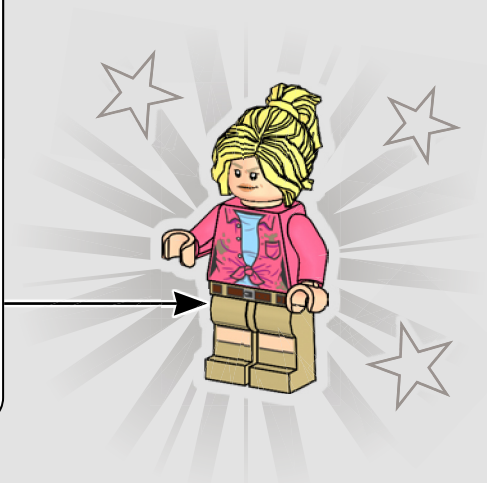
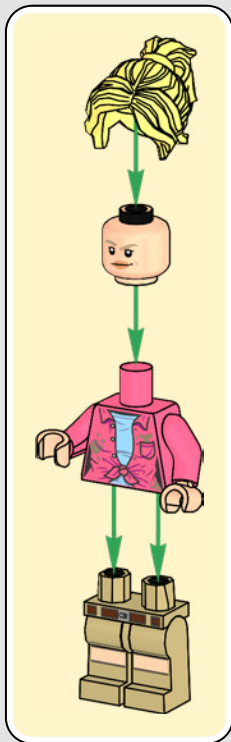

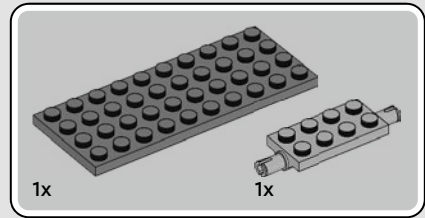
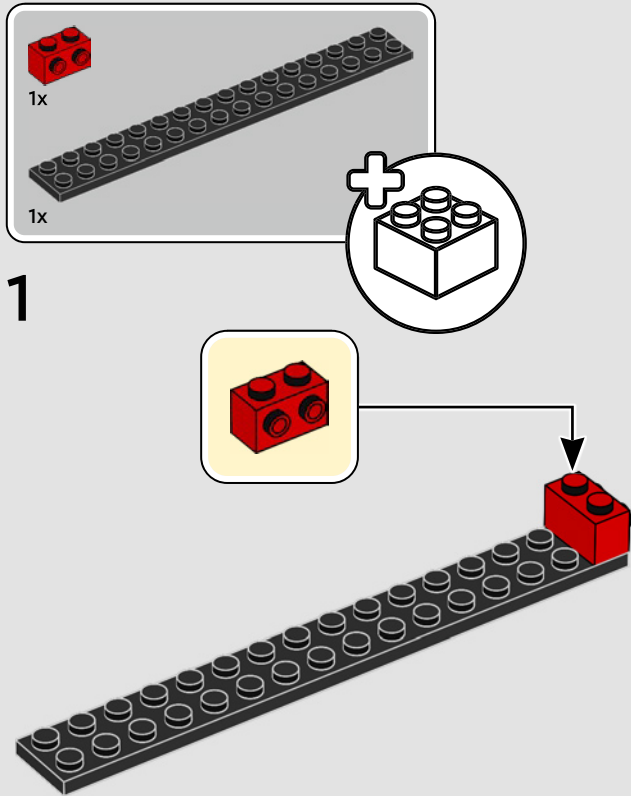

2

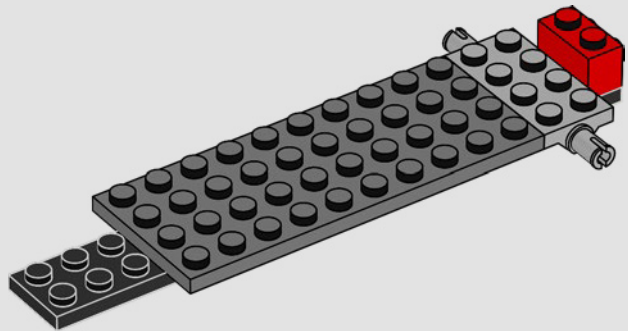

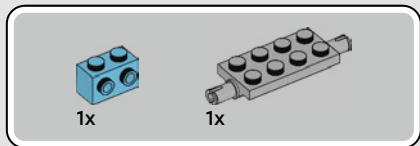

3

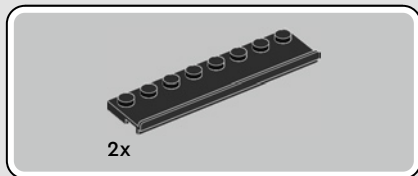
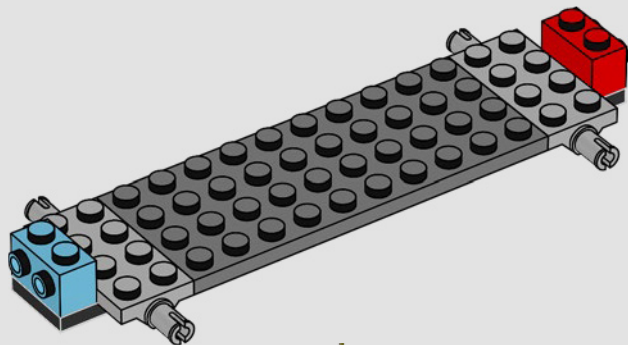

4

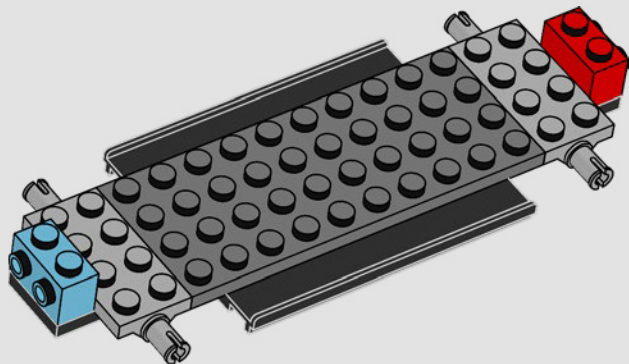



2x

5

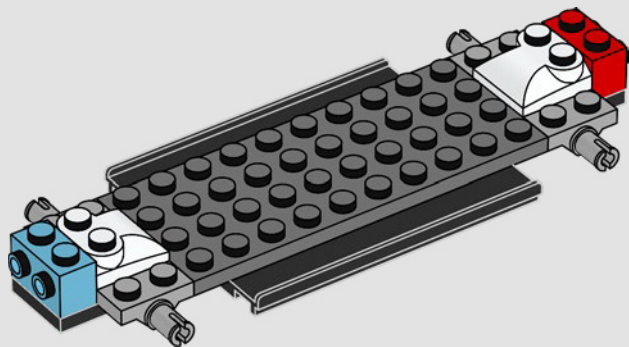

2x

6

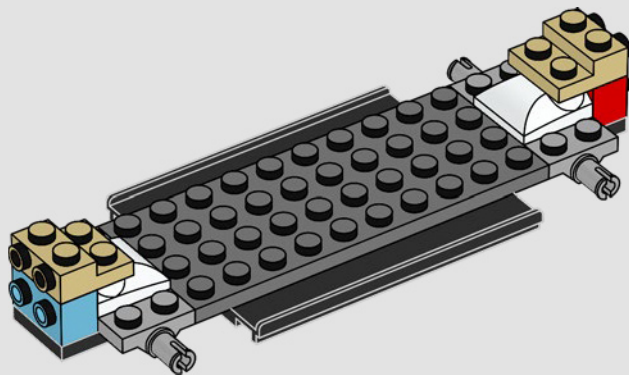

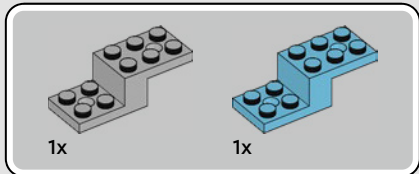

7

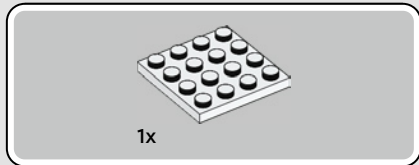
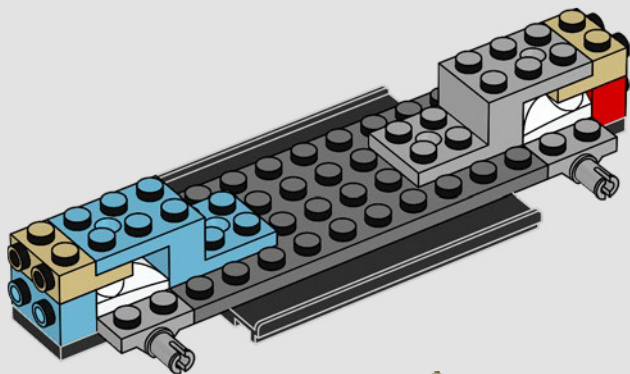

8

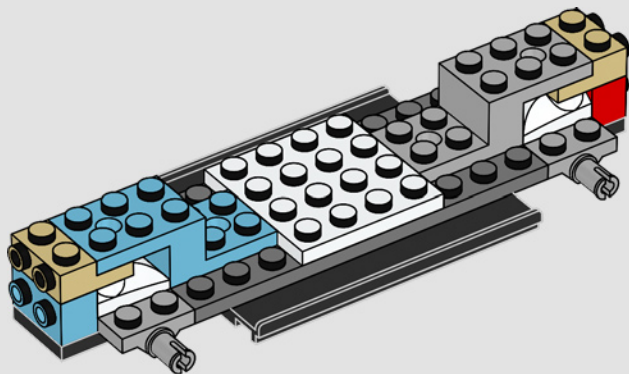

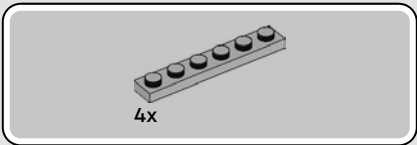

9

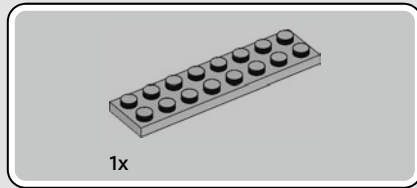
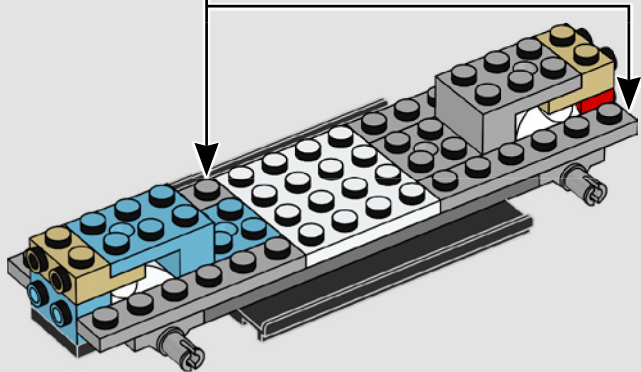
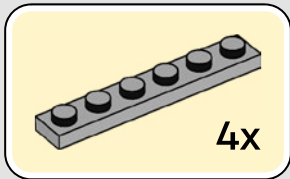

10

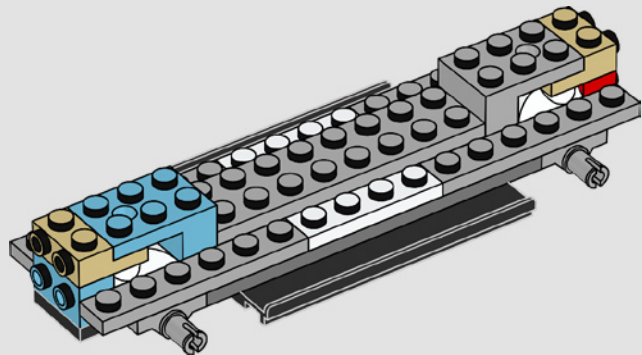

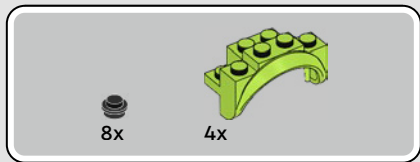

11

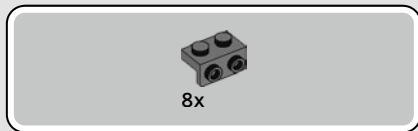
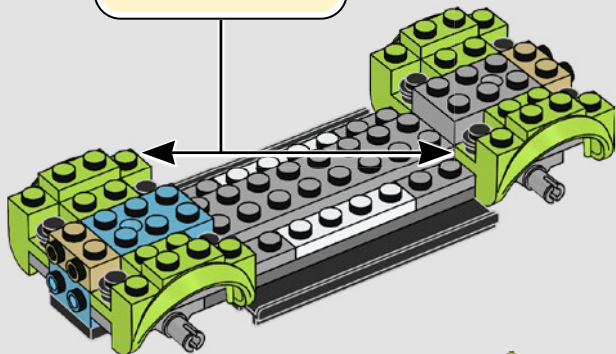
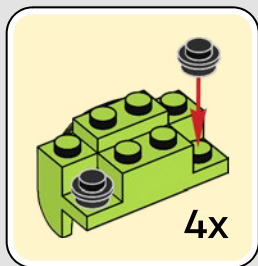

12

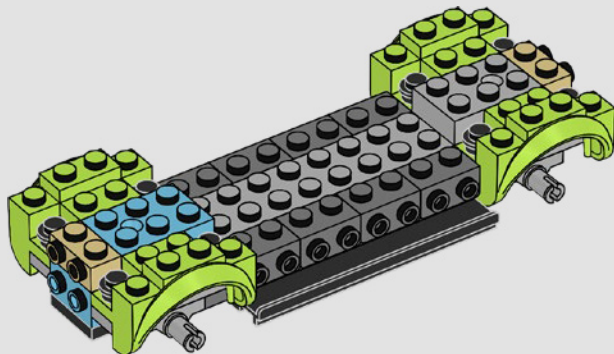



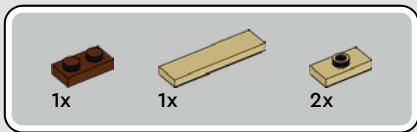

13

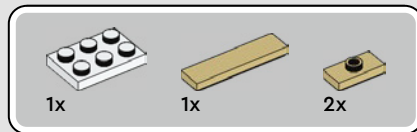
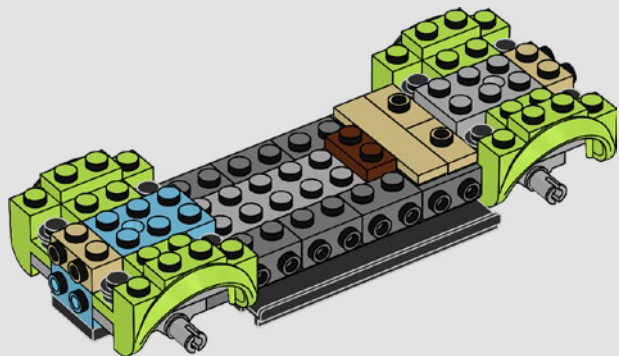

14

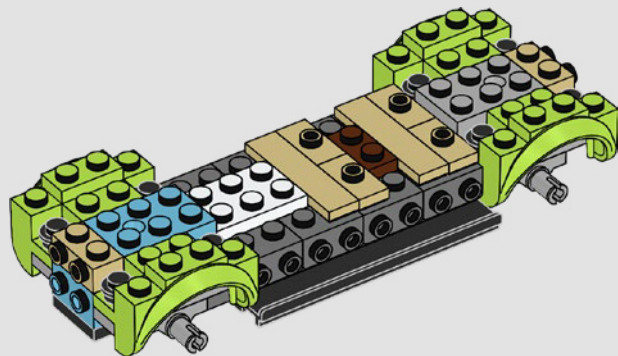



6x

15

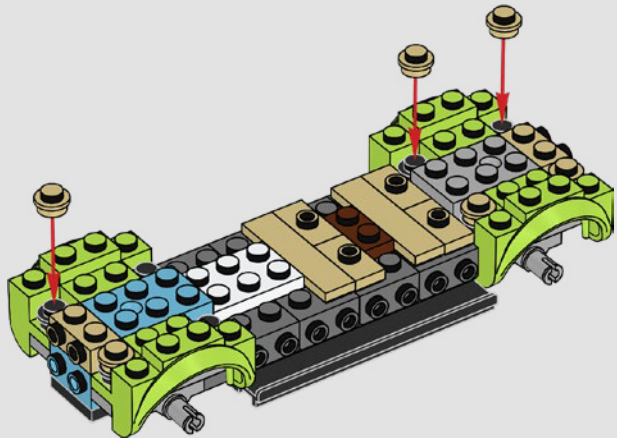

3x

16

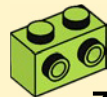

3x

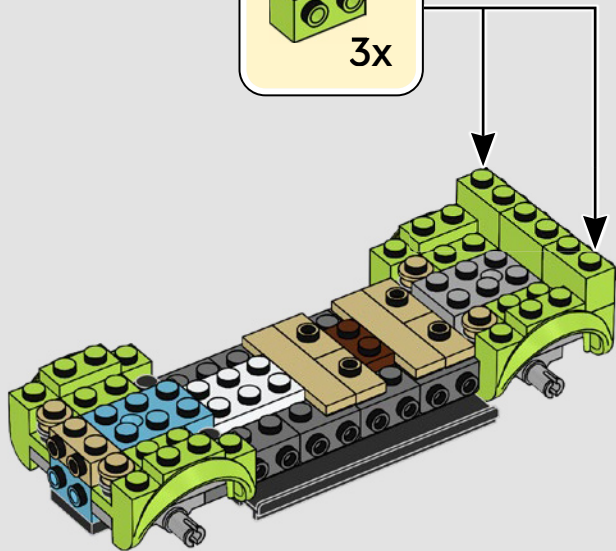

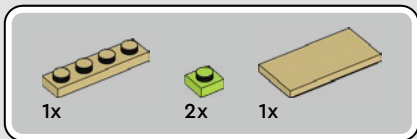

17

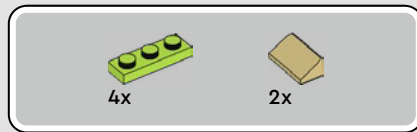
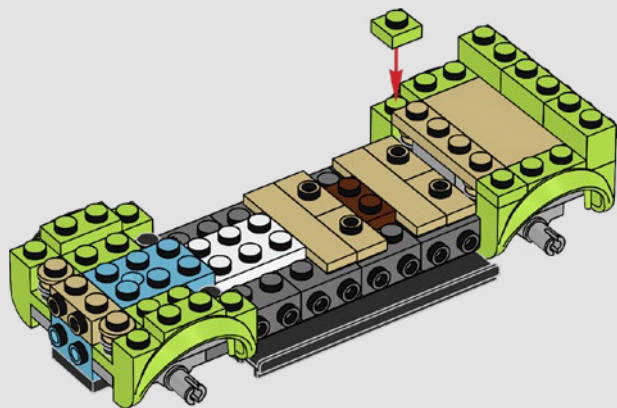

18

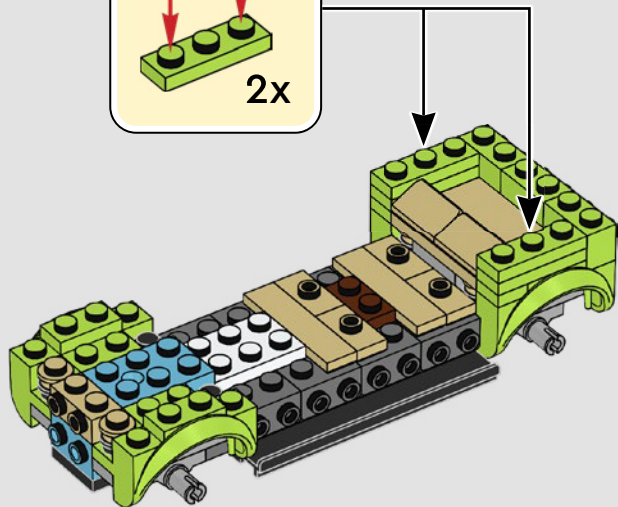
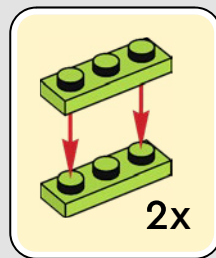



2x



4x

# 19

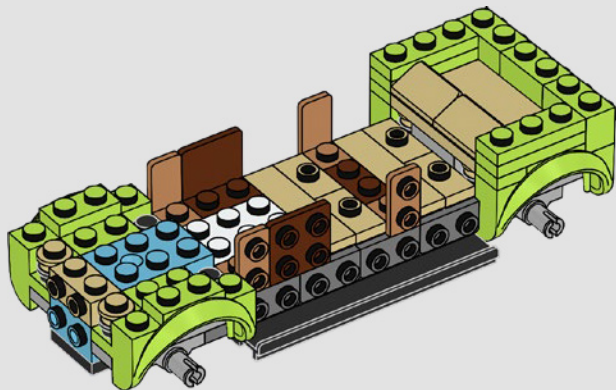

2x



2x

# 20

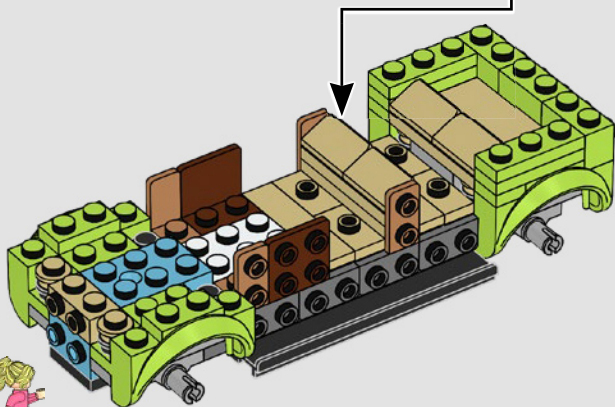
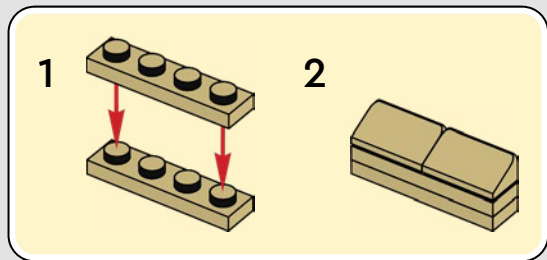



1x



2x

# 21



2x

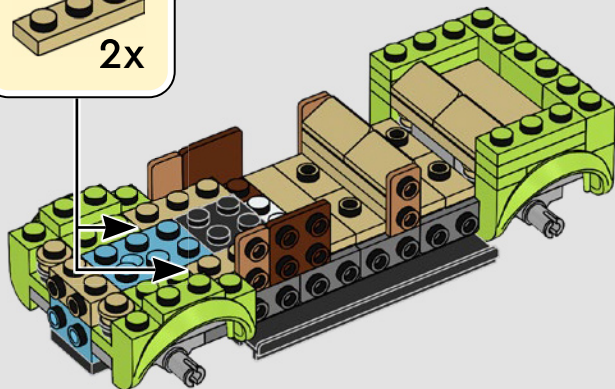

1x



1x

# 22

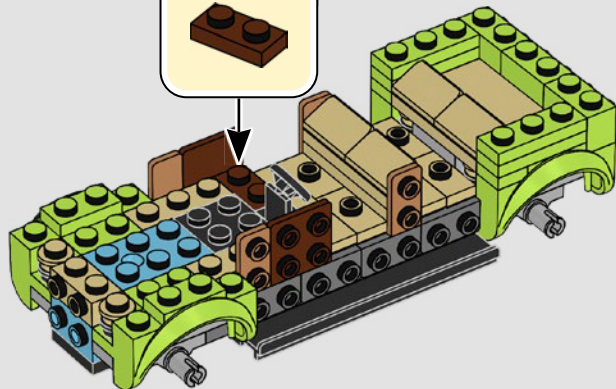

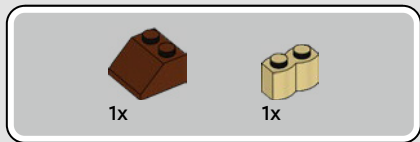

23

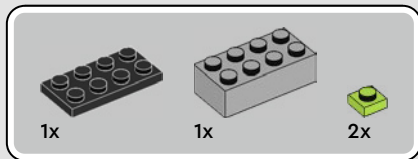
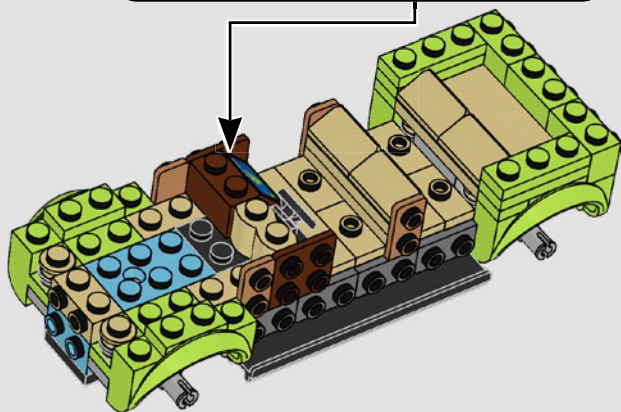
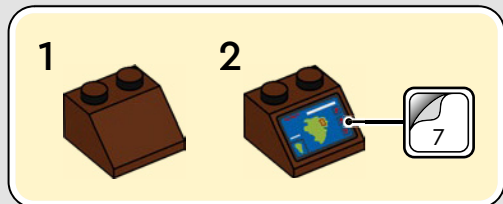

24

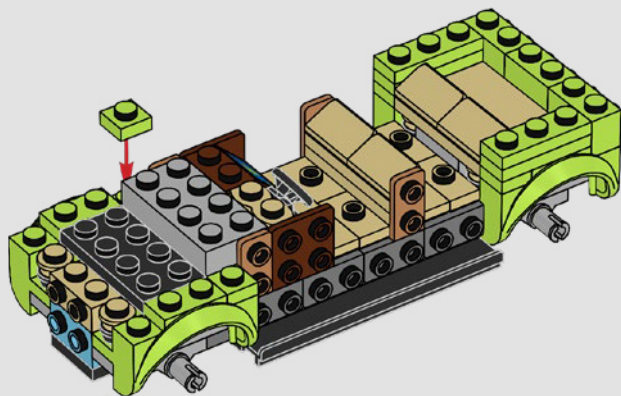



4x

25

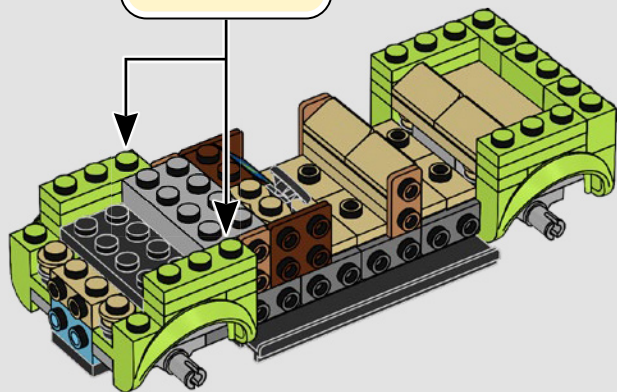
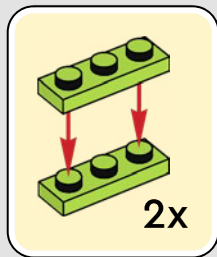

3x

26

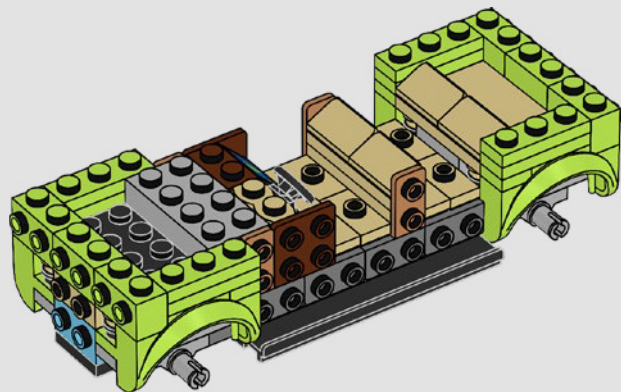

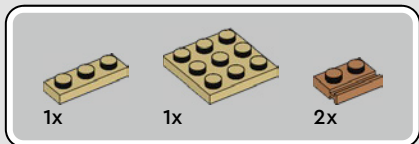

27

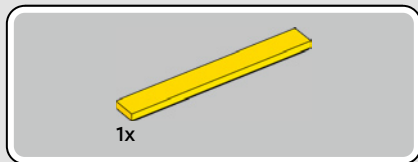
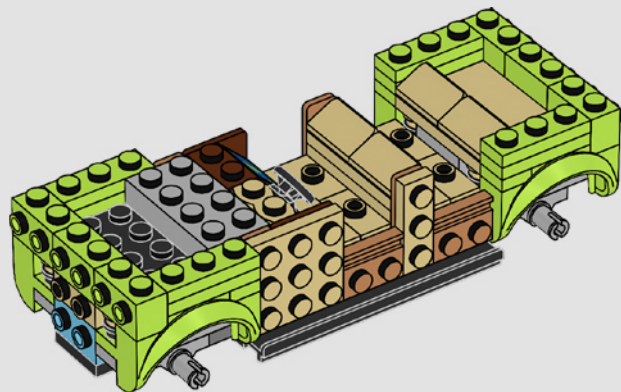

28

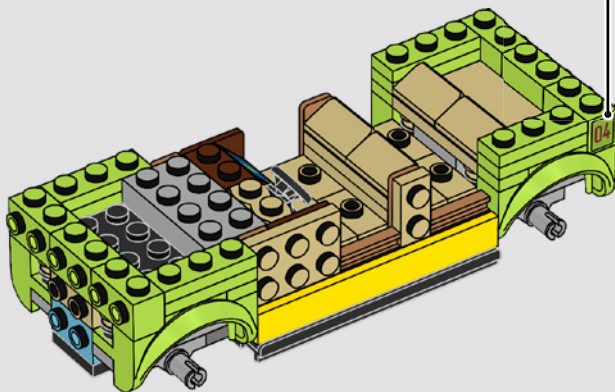



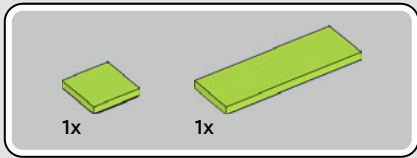

29

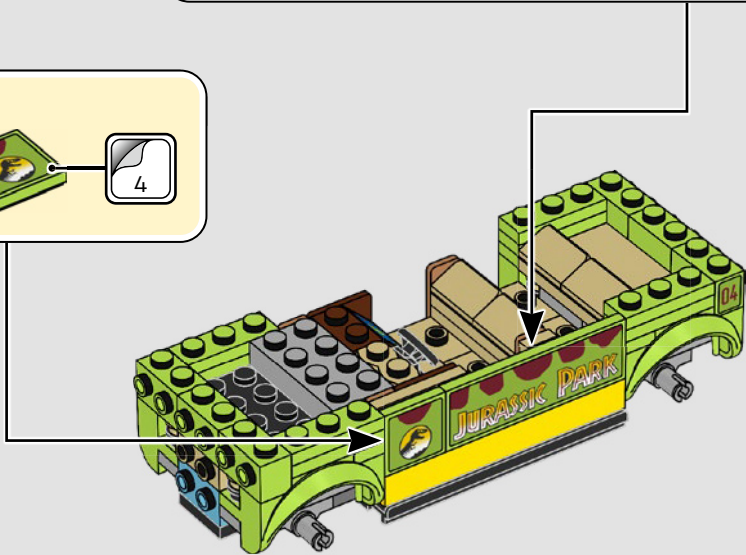
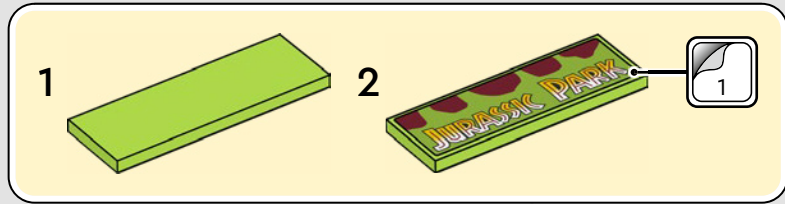

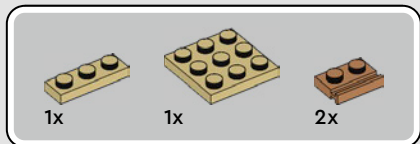

30

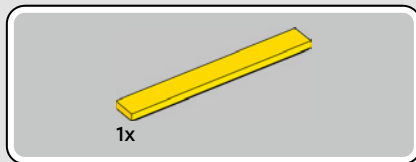
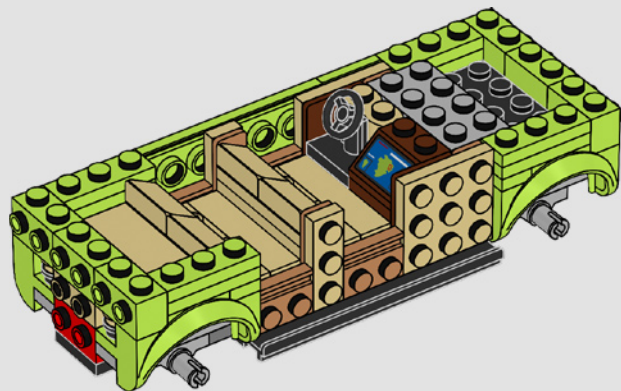

31

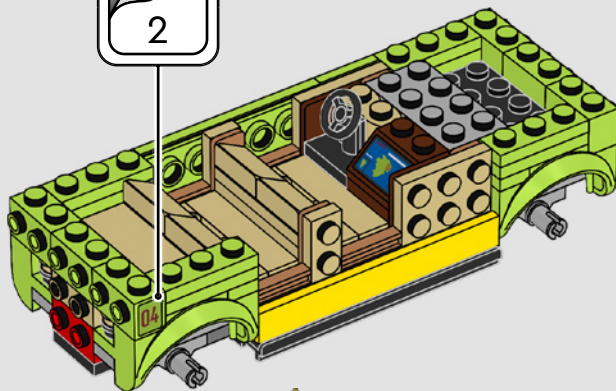

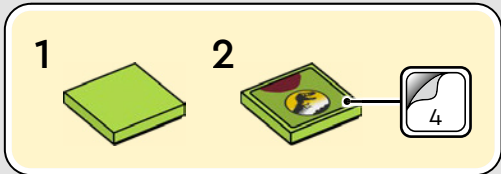
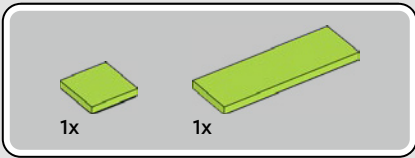

# 32

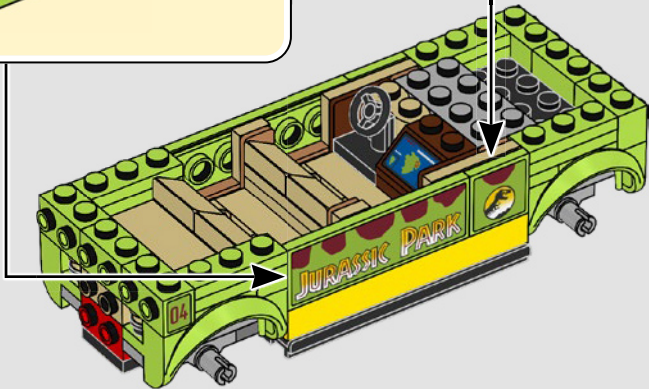
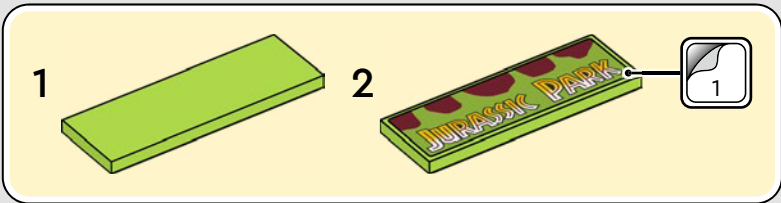

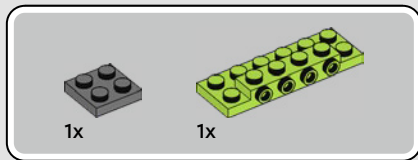
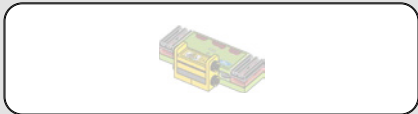

33

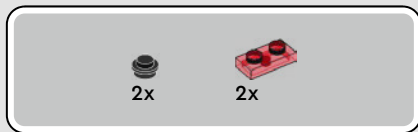
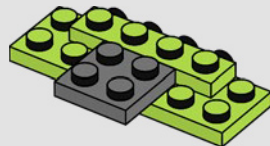

34

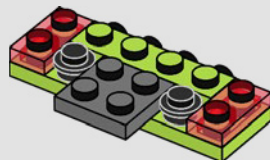

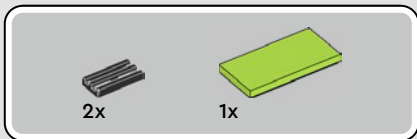

35

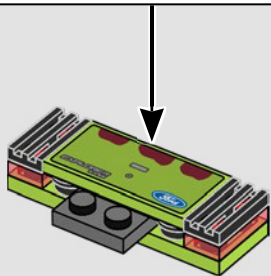
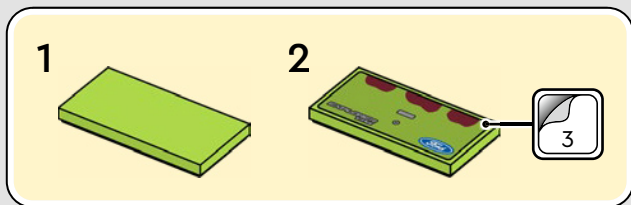

36

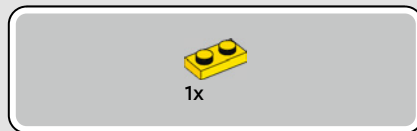
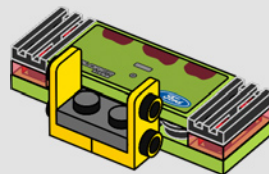

37

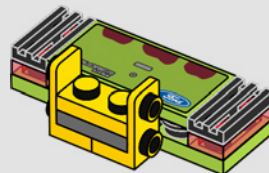



1x

38

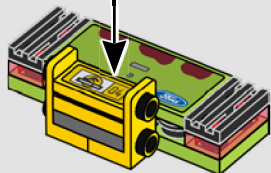
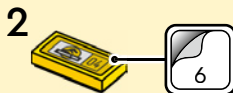
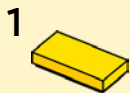

39

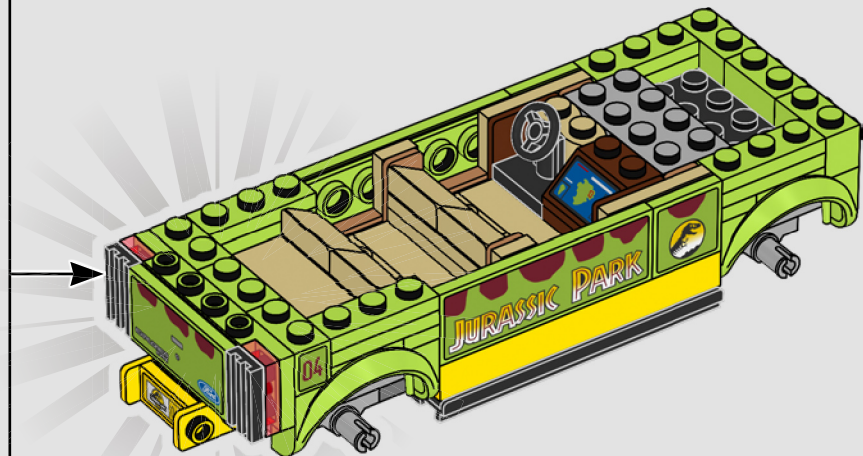

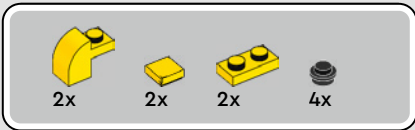

40

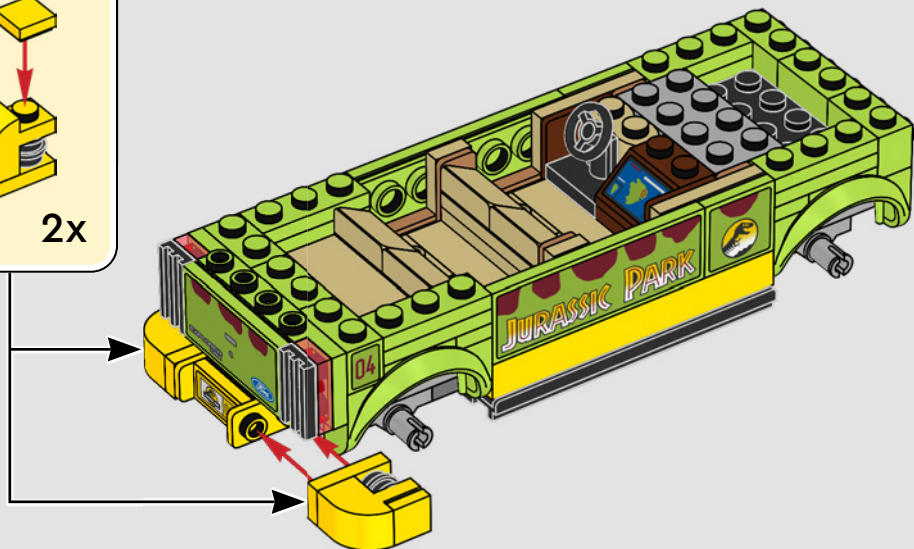
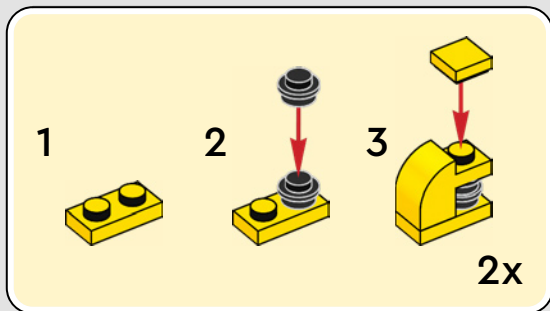

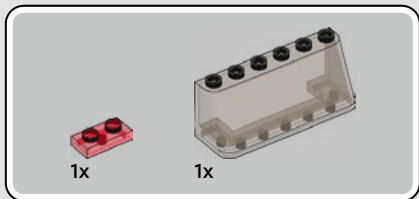

41

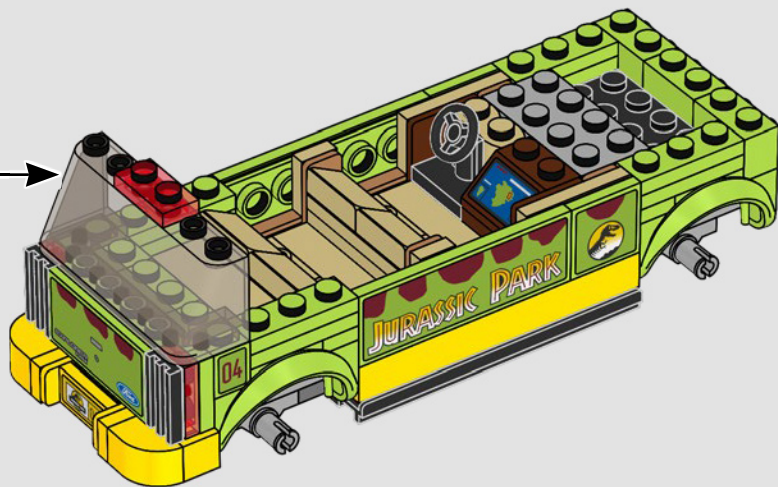
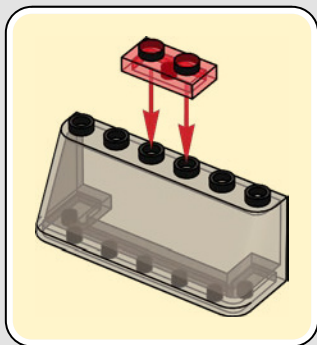



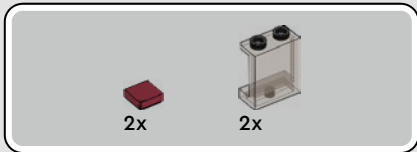

42

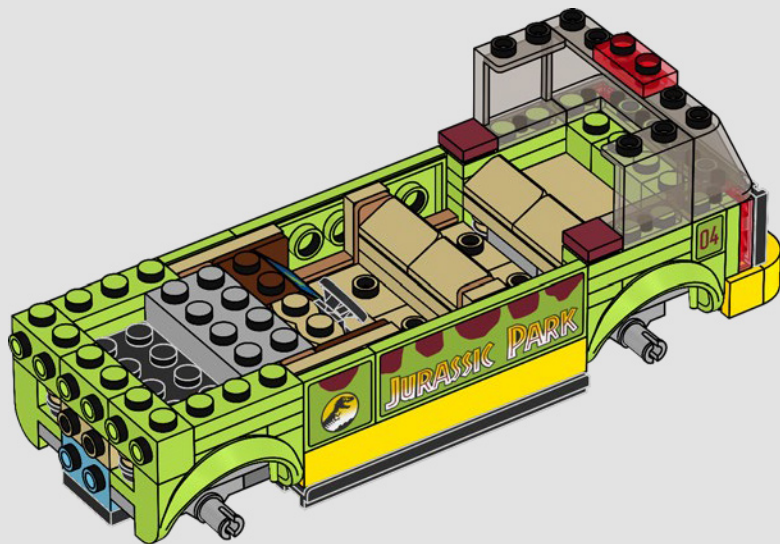



1x



1x

43

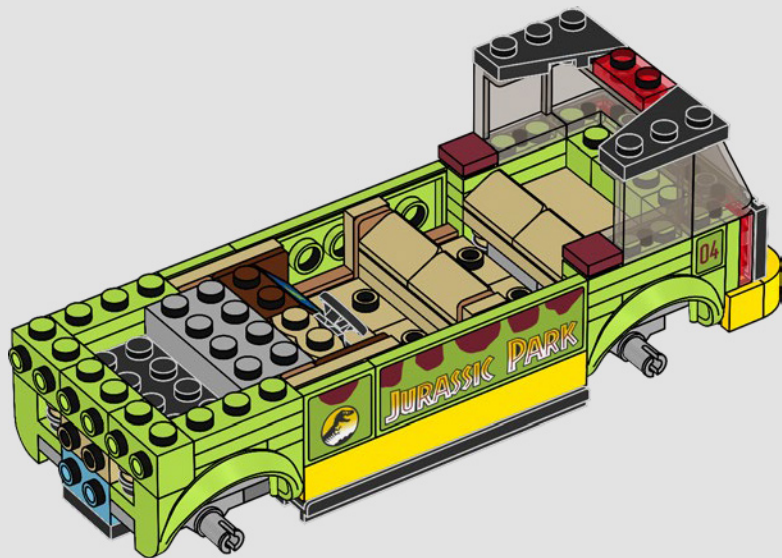

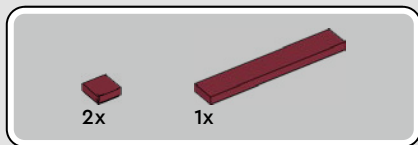

44

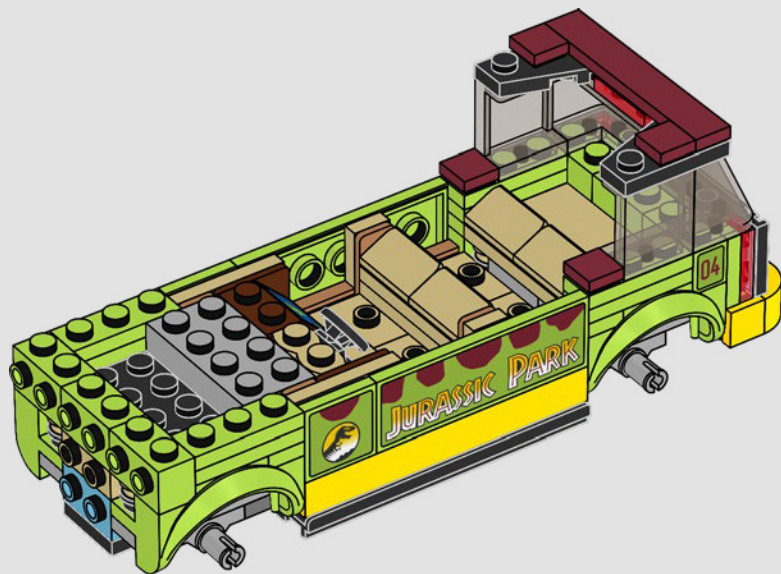

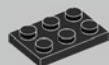

1x

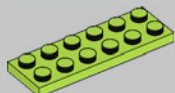

1x

# 45

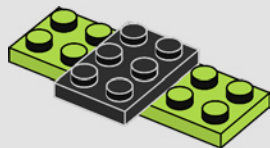

2x



2x



2x

# 46

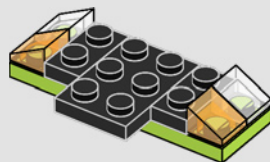

1x



2x

# 47

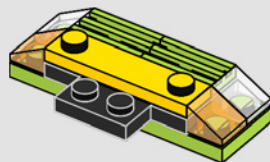



2x

48

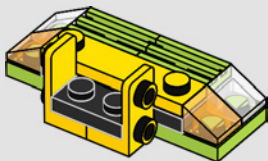

1x



1x

49

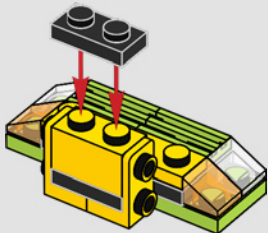

2x

50

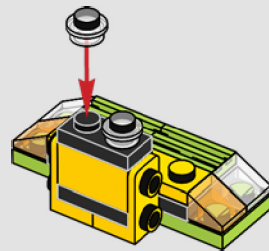

51

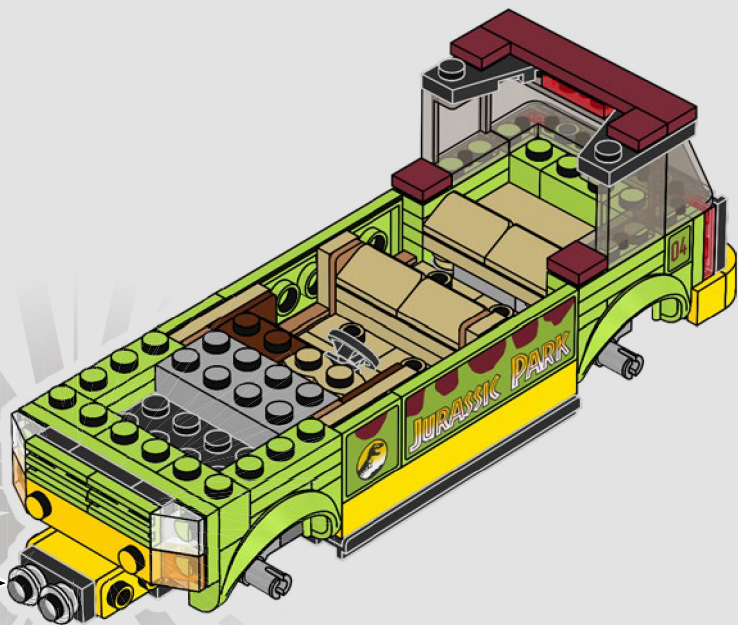

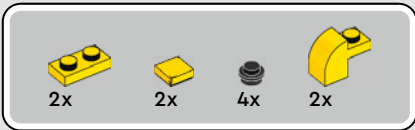

52

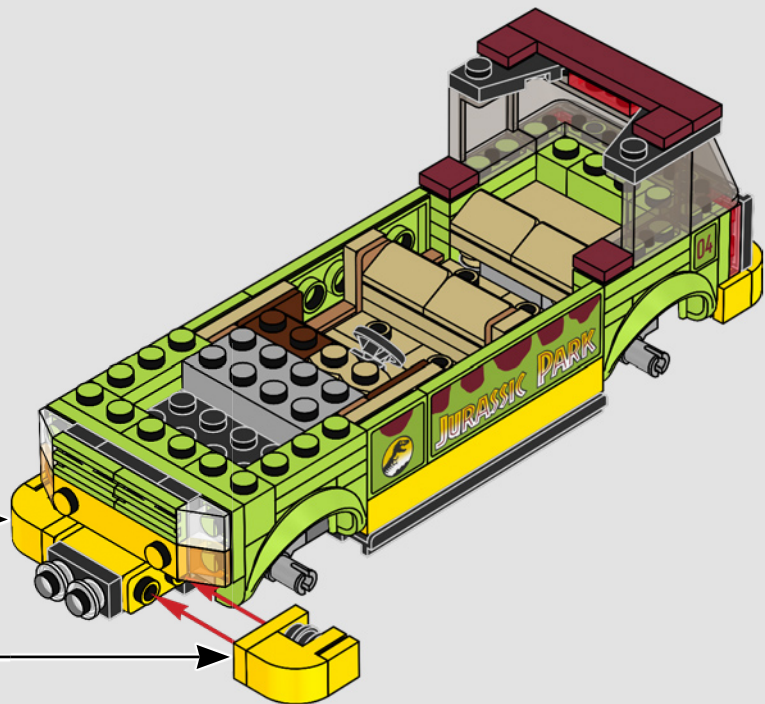
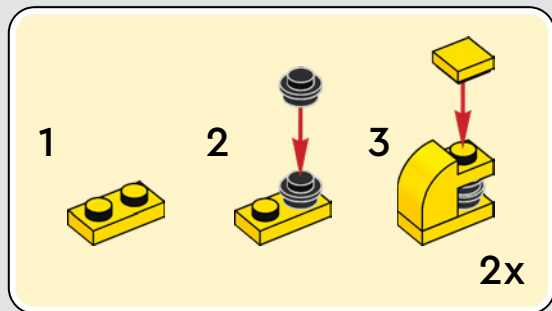



1x

53

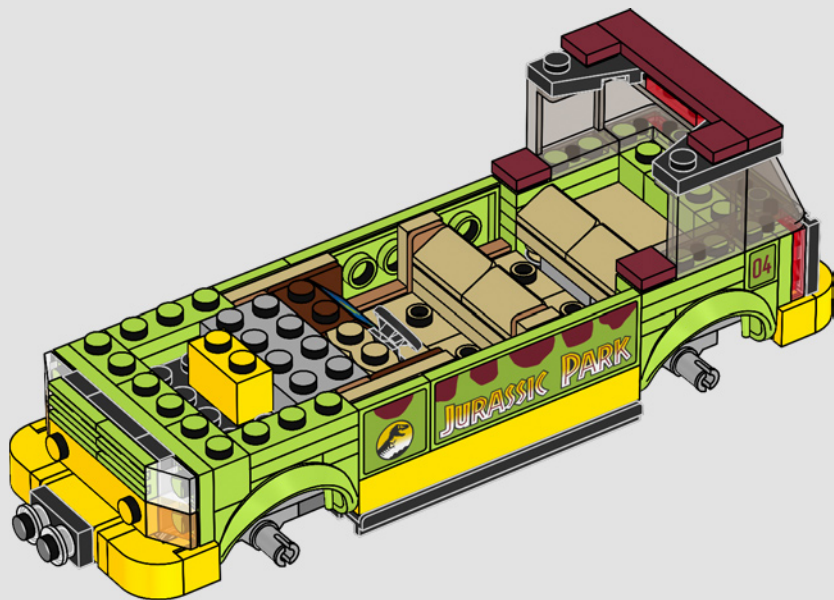



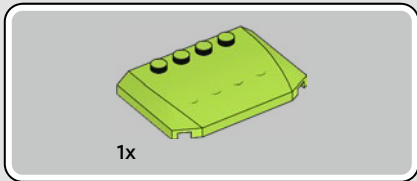

54

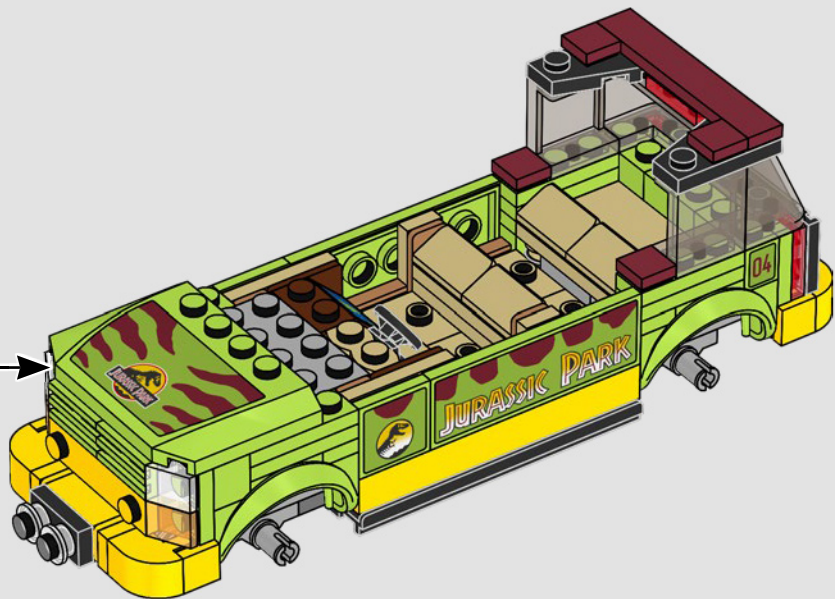
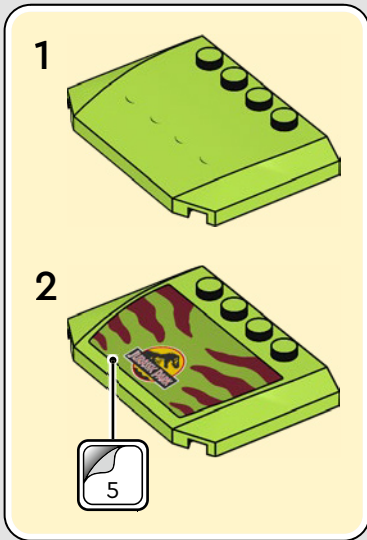

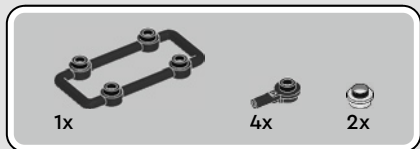

55

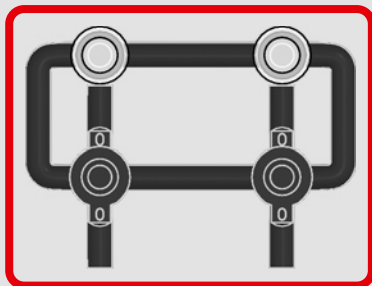

1

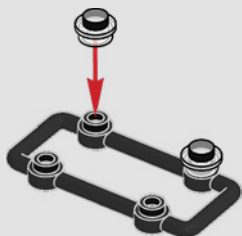

2

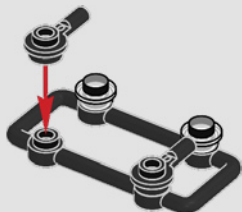

3

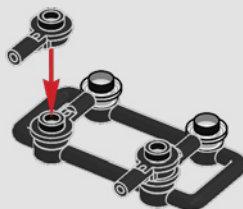

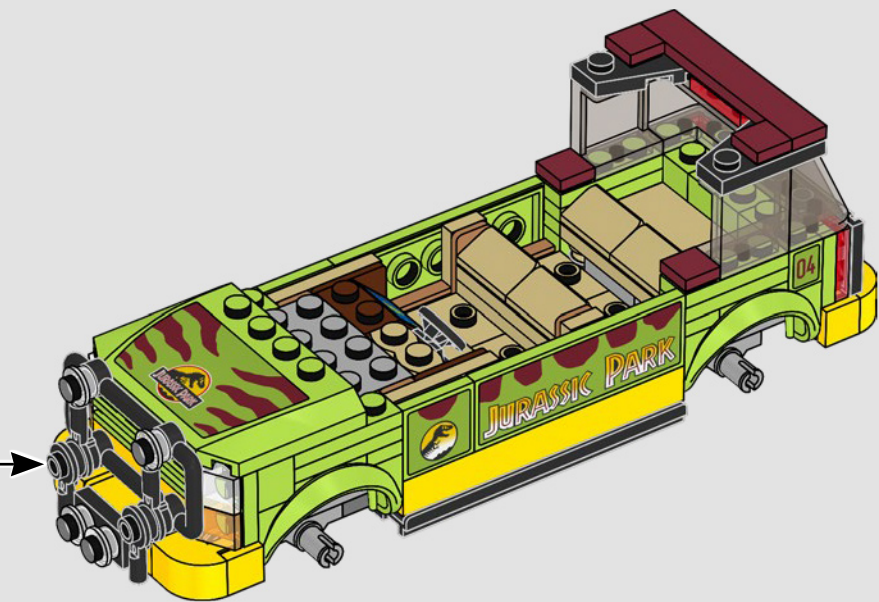



4x



2x

# 56

1



2



2x

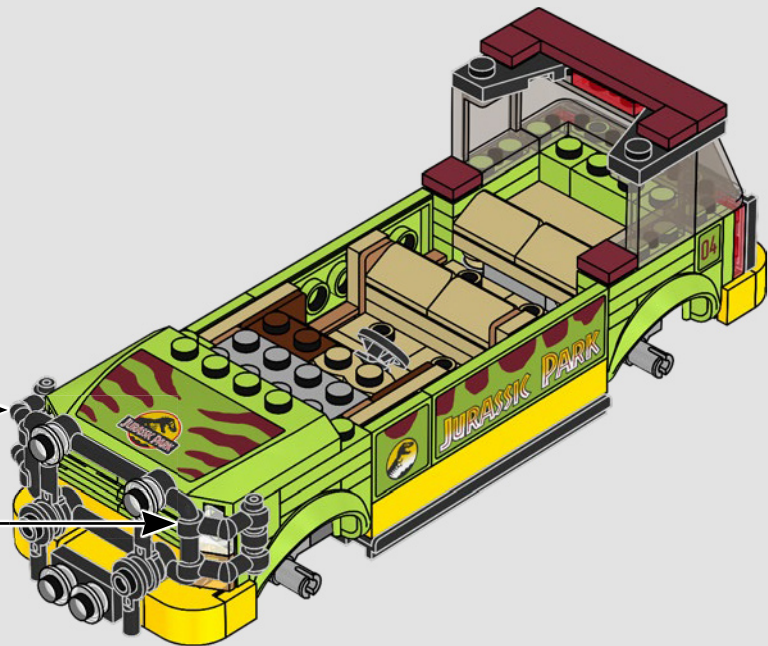

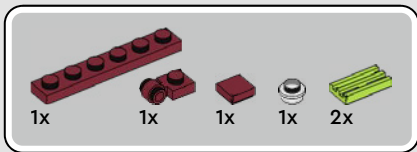

57

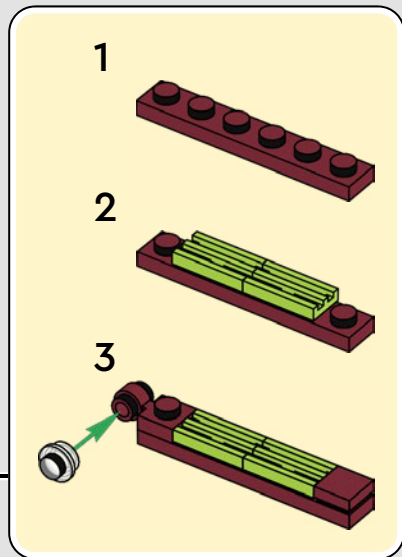
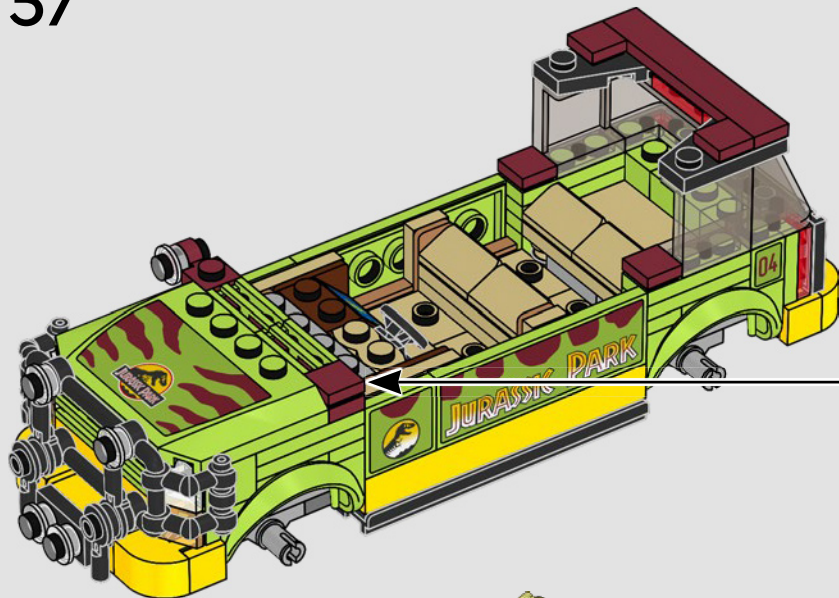

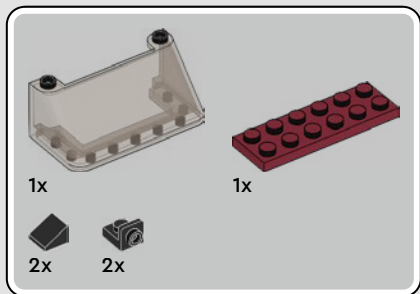

58

1

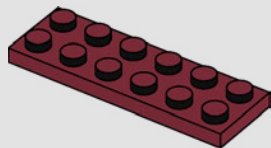

2

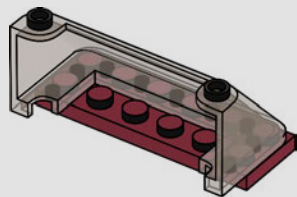

3

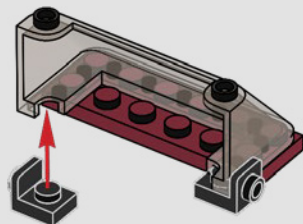

4

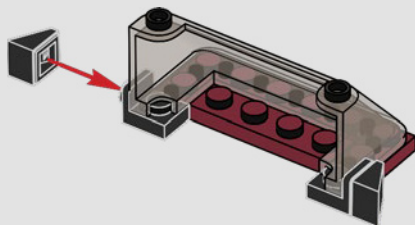

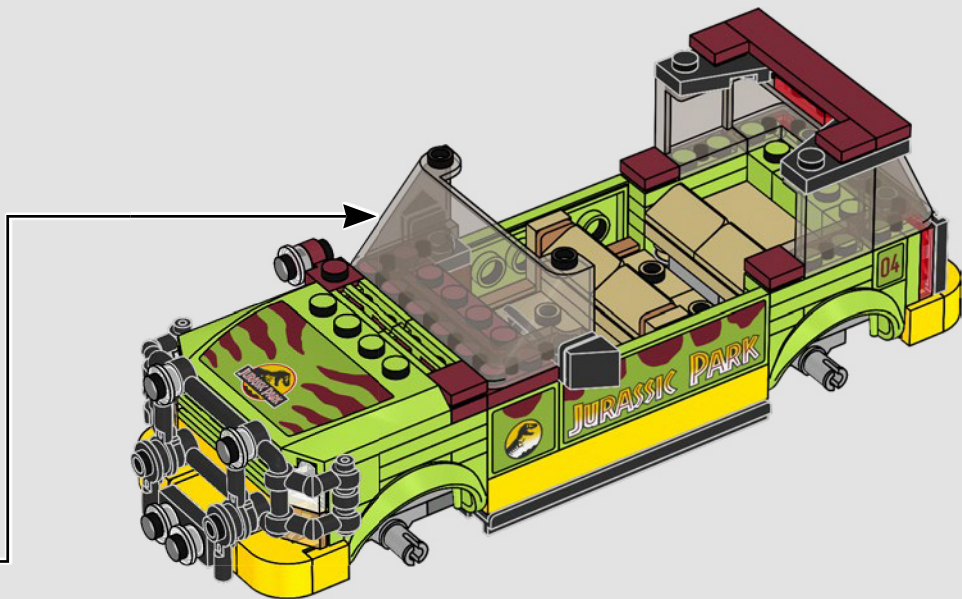

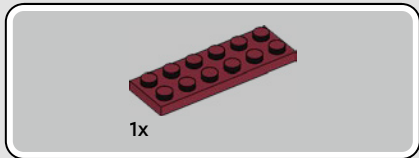
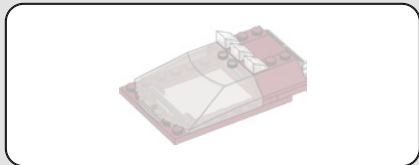

59

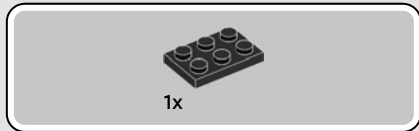
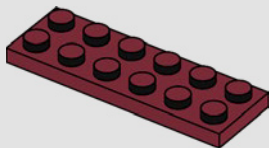

60

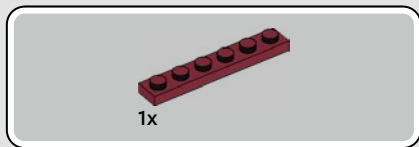
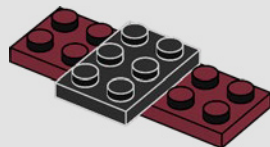

61

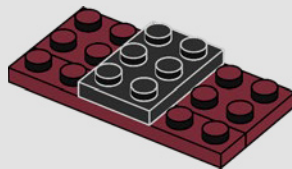



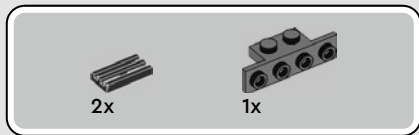

62

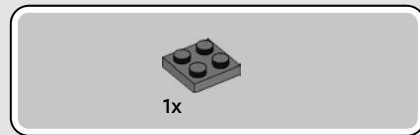
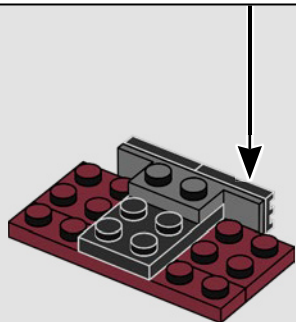
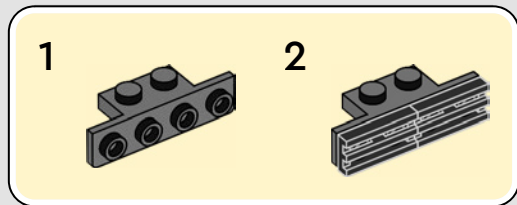

63

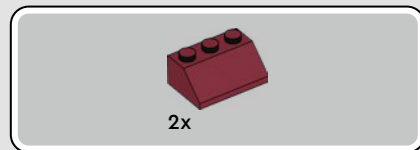
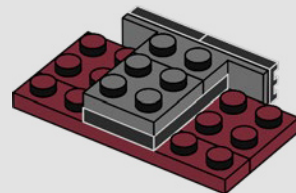

64

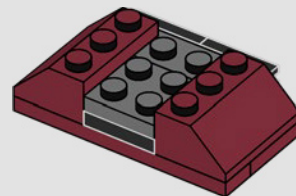

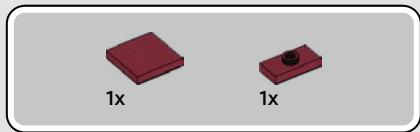

65

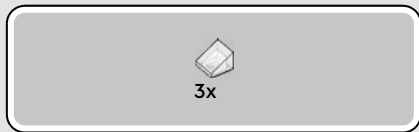
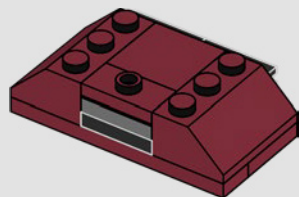

66

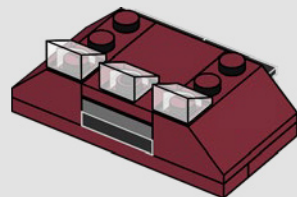

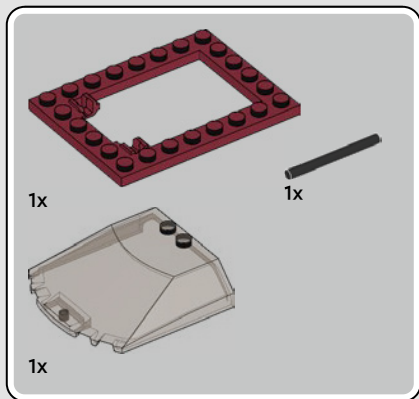

67

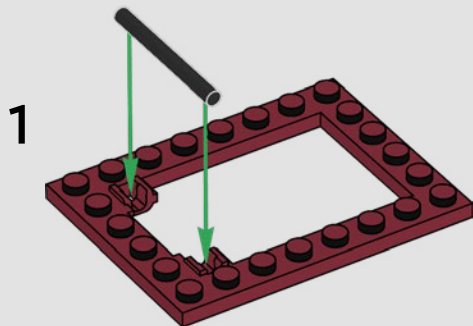

2

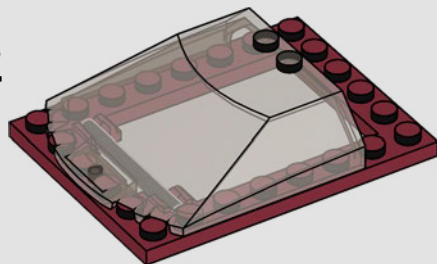

68

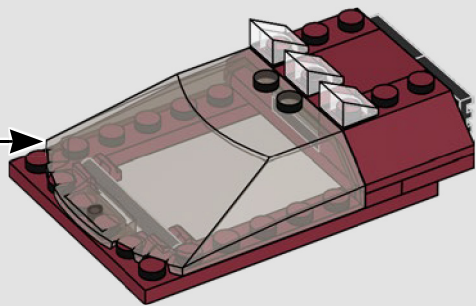

69

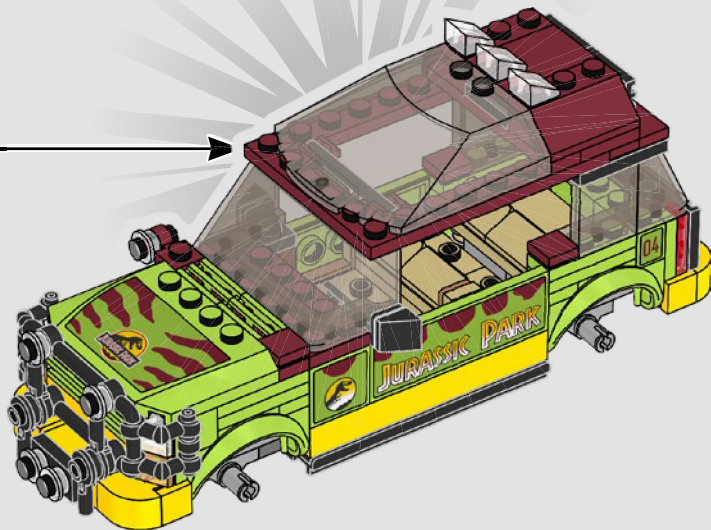

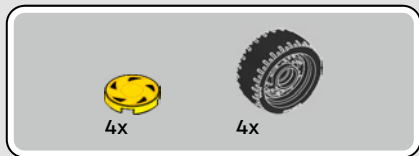

70

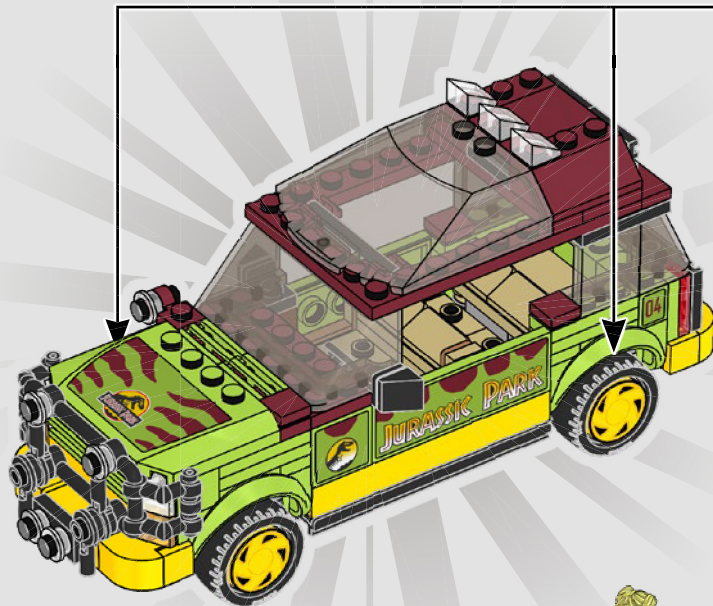

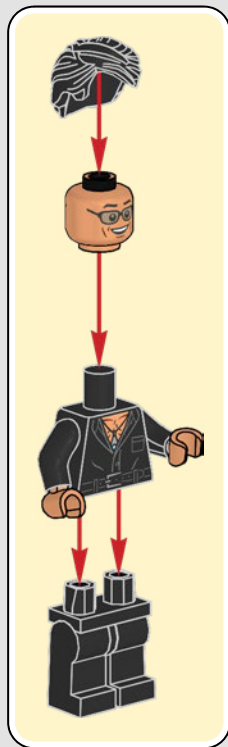

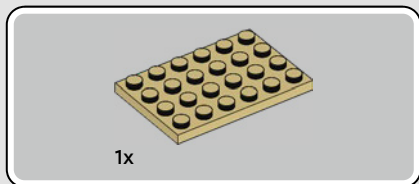
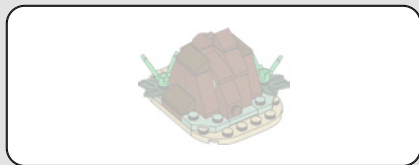

1

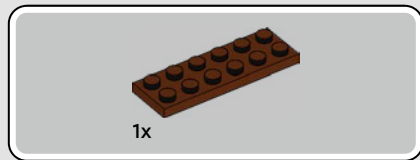
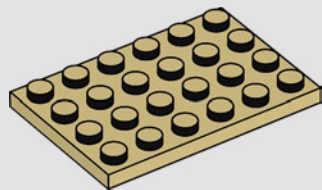

2

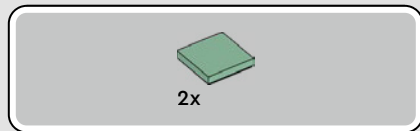
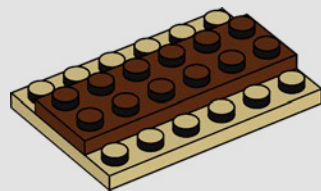

3

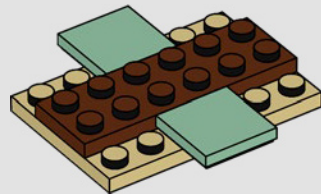



2x

4

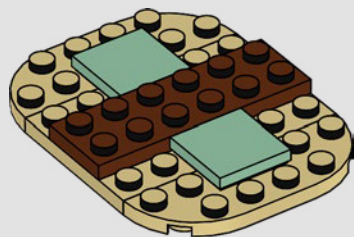

4x

5

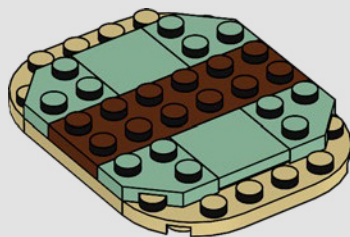





2x

6

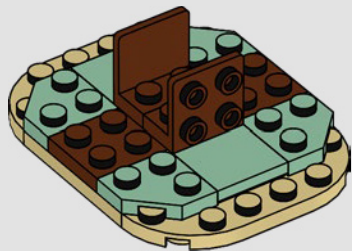

1x

7

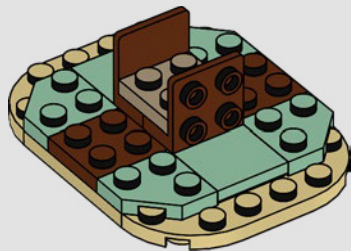

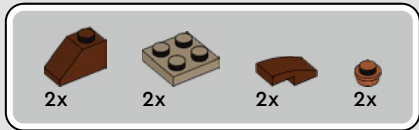

8

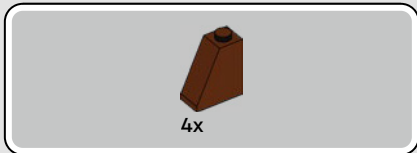
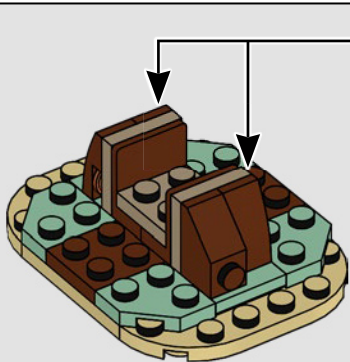
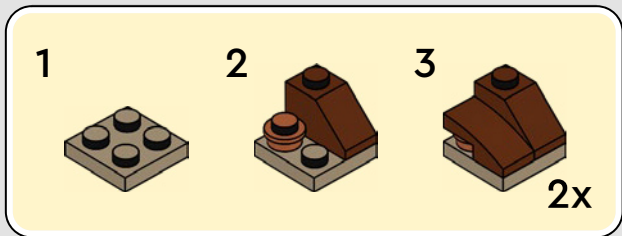

9

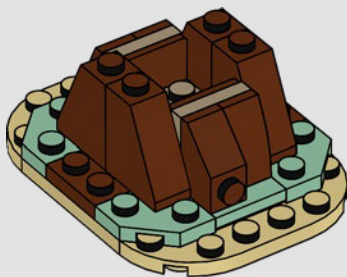



4x

10

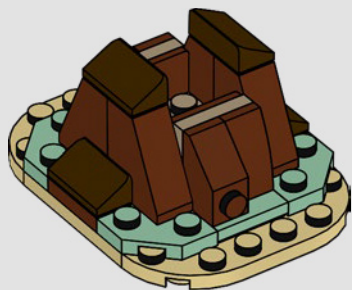

2x

11

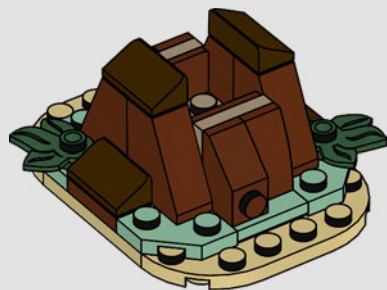



2x

12

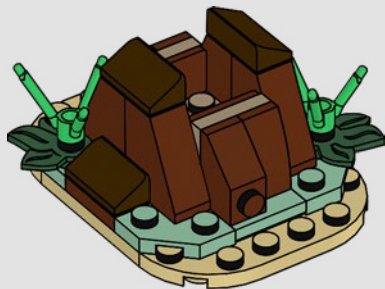

1x

13

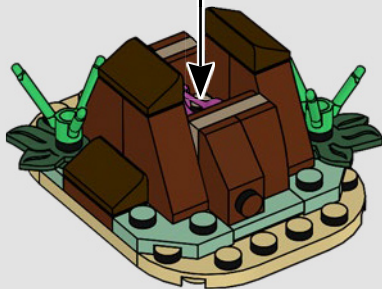

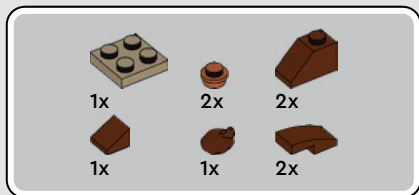

14

1



2



3

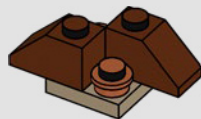

4

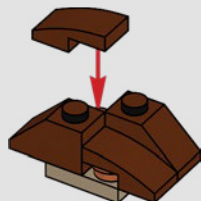

5

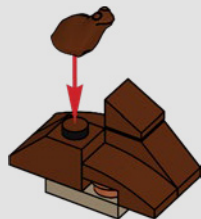

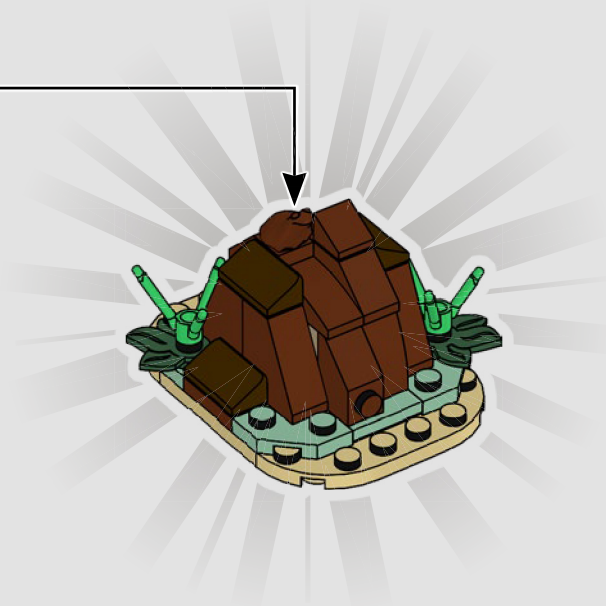





76961









1x  
6100562



4x  
6047415



2x  
6400754



2x  
6133896



4x  
6233984



2x  
6439884



5x  
4550169



1x  
6092597



1x  
4539105



1x  
4650865

2x  
4539062



2x  
4618986



1x  
6282000



1x  
6389824



2x  
6245265



1x  
4504376



4x  
4211199



4x  
4629736



1x  
4211202



4x  
6069984



2x  
4211150



1x  
4211247



4x  
6226436



1x  
6436308



1x  
6436311



1x  
6436310



1x  
6436313

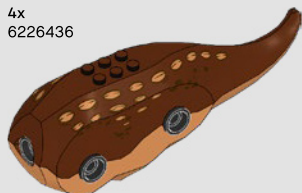

1x  
6442974



1x  
6436312



1x  
6234347



1x  
4211385



1x  
6028811



4x  
4211438



1x  
4211406



2x  
4211094



1x  
4211122



8x  
6214341



1x  
6271127



1x  
4211006



1x  
6390255



1x  
6226739



4x  
6127366



4x  
6380634



4x  
6433739



1x  
6348142



1x  
6355732



1x  
6441067



 [LEGO.com/service](https://www.lego.com/service)

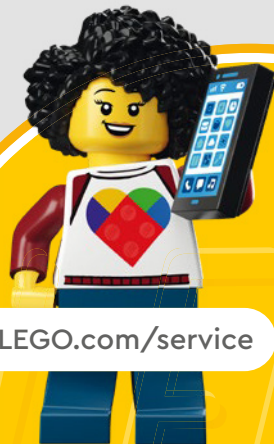

YOU COULD  
**WIN**



Scan this QR code or go to  
**LEGO.COM/PRODUCTFEEDBACK** and give  
us your short feedback about this LEGO® set  
for a chance to win a cool LEGO prize.

Terms and Conditions apply\*

**EN: YOU COULD WIN.** Terms and Conditions apply\* **DE: Du könntest GEWINNEN.** Es gelten die Teilnahmebedingungen\* **FR: Tu pourrais GAGNER.** Des conditions s'appliquent\* **IT: Potresti VINCERE tu.** Termini e condizioni sono applicabili\* **ES: Puedes GANAR.** Aplican términos y condiciones\* **PT: Poderá GANHAR.** Aplicam-se termos e condições\* **ZH: 轻松获奖. 条款和条件适用\*** **PL: Szansa na WYGRANĄ.** Obowiązują warunki korzystania\* **CS: Máte šanci VYHRÁT.** Platí všeobecné smluvní podmínky\* **SK: Máte šancu VYHRÁŤ.** Platia všeobecné zmluvné podmienky\* **HU: TE IS NYERHETSZ.** Felhasználási feltételek érvényesek\* **RO: Ai putea CÂȘTIGA.** Se aplică termenii și condiții\* **BG: Можете да СПЕЧЕЛИТЕ.** Има определени правила и условия\* **LV: Tu vari LAIMĒT.** Ir spēkā noteikumi un nosacījumi.\* **ET: Sul on võimalus VÕITA.** Kehtivad tingimused\* **LT: Jūs galite LAIMĖTI.** Taikomos sąlygos\*

\*[LEGO.com/productfeedback-terms](https://www.lego.com/productfeedback/terms)

LEGO and the LEGO logo and are trademarks of the LEGO Group. ©2023 The LEGO Group.  
© Universal City Studios LLC and Amblin Entertainment, Inc. All Rights Reserved.  
Ford Motor Company Trademarks and Trade Dress used under license to the LEGO Group.

6465905