



NINJAGO

DRAGONS RISING

71798



2



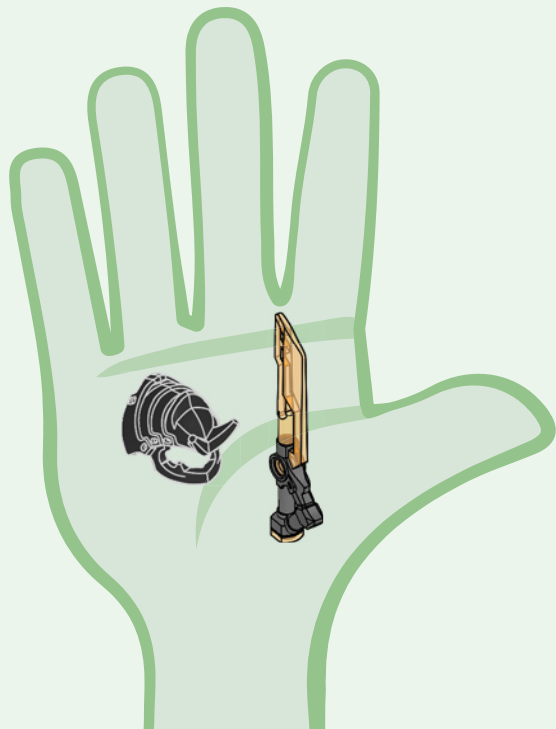
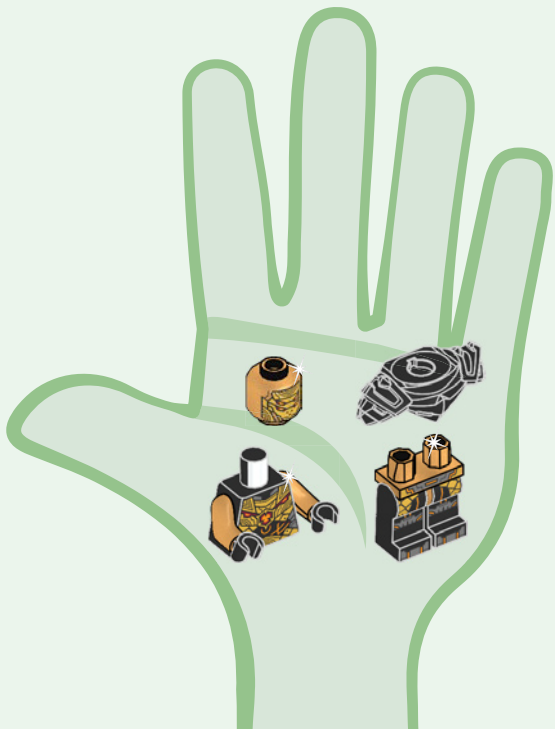

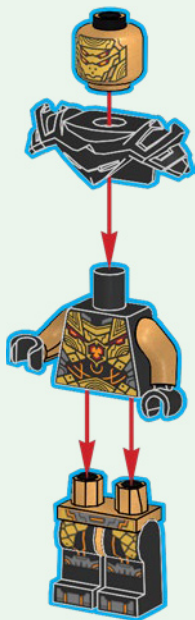

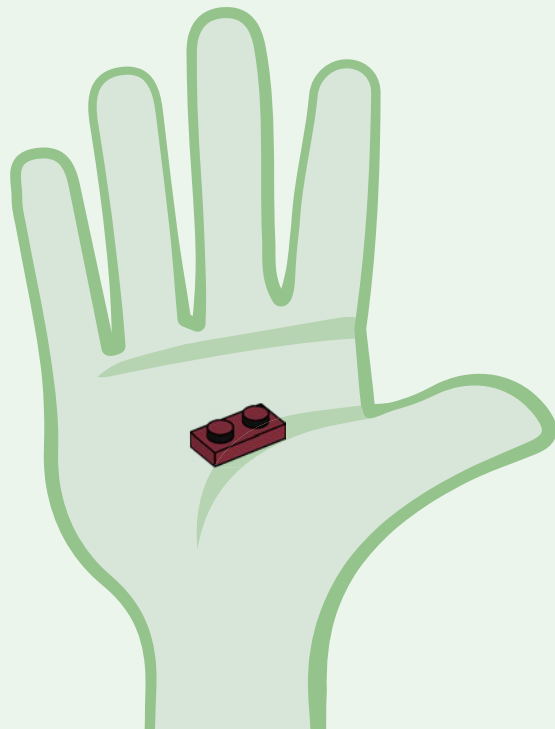
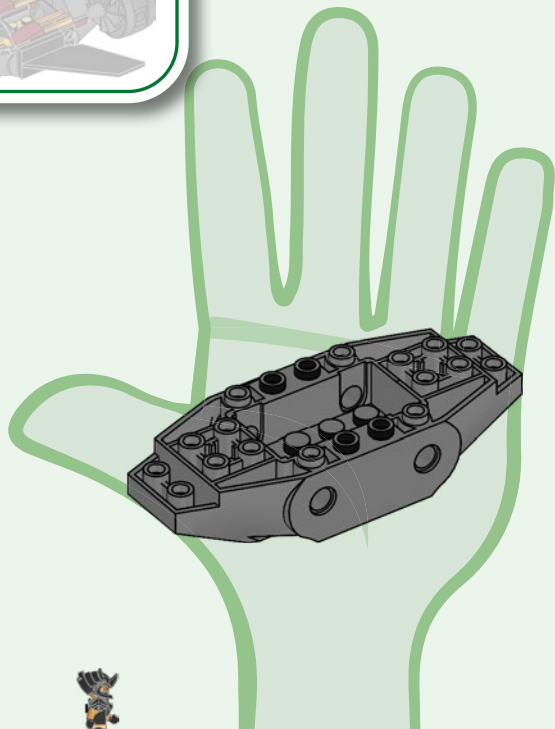
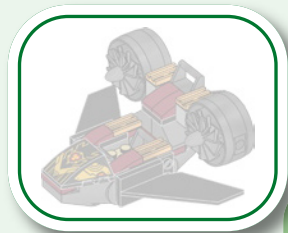

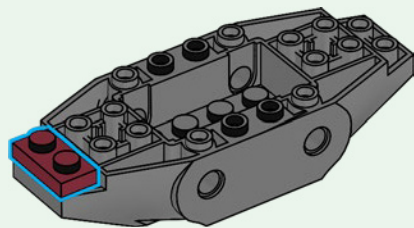
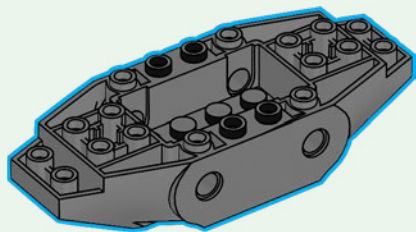

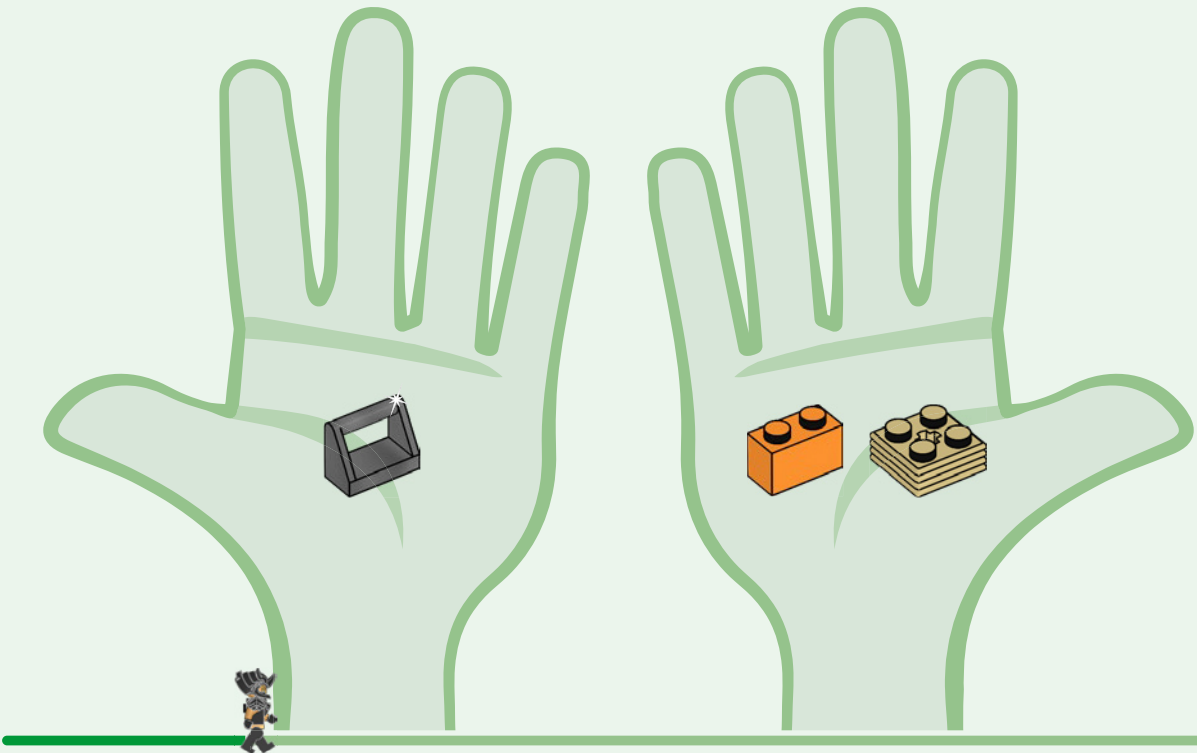

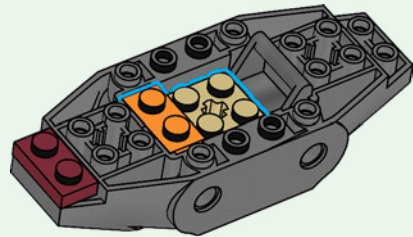
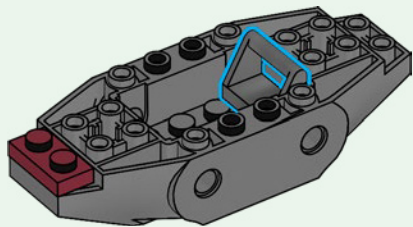





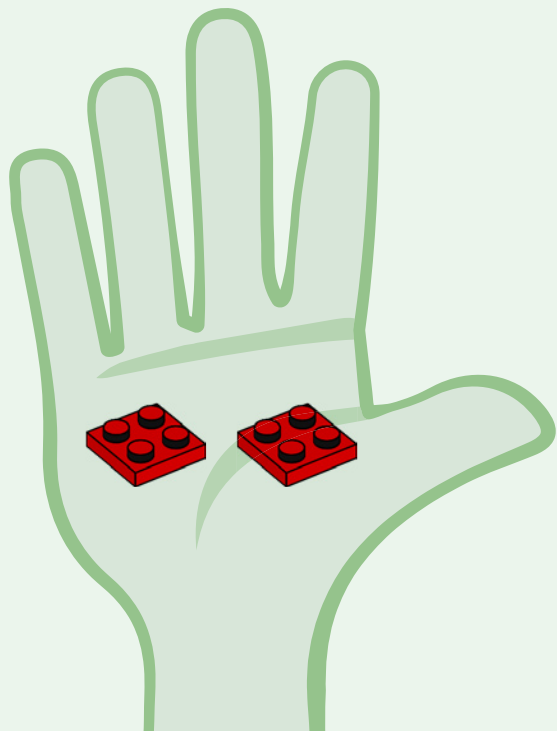
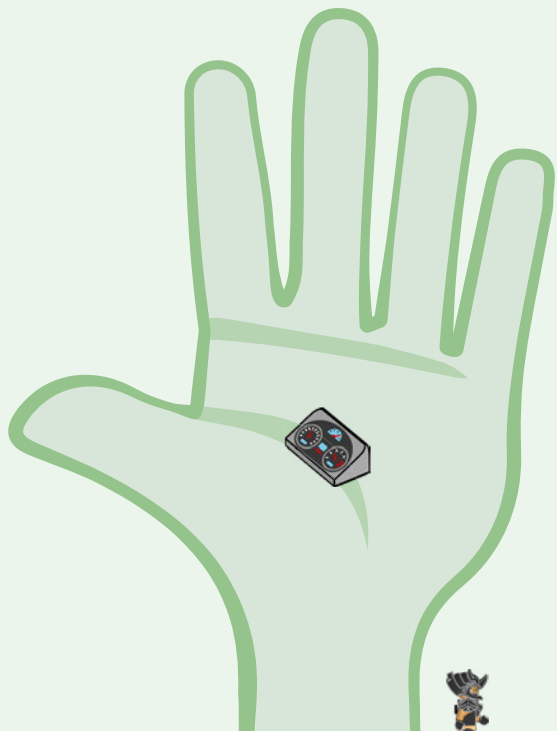

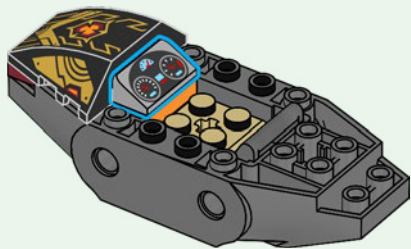

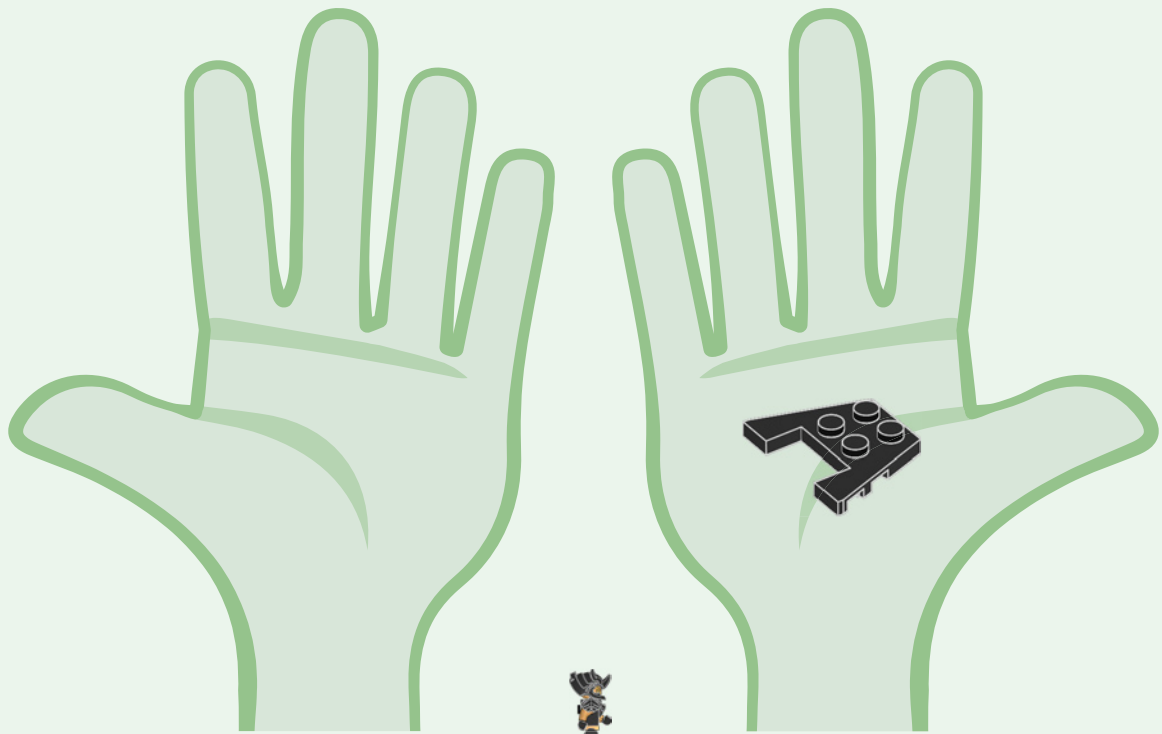



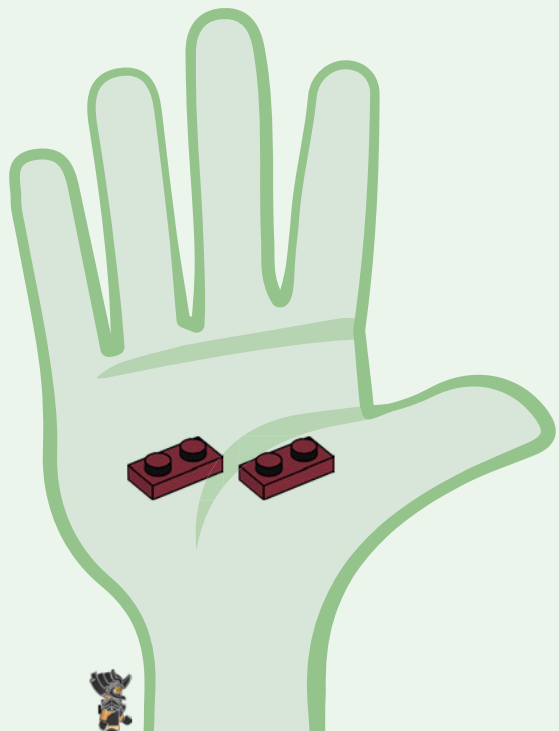

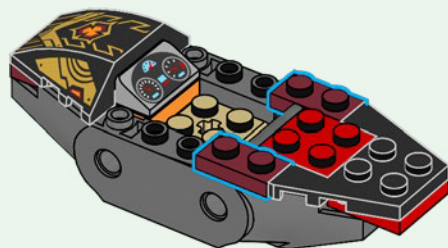

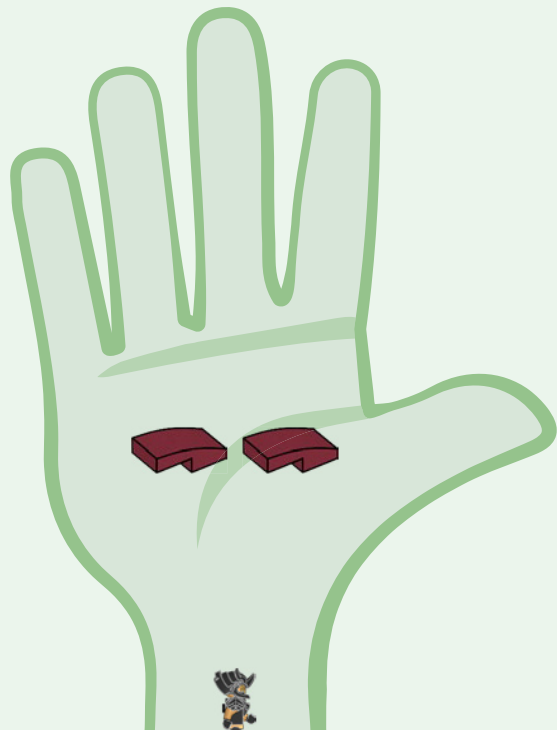
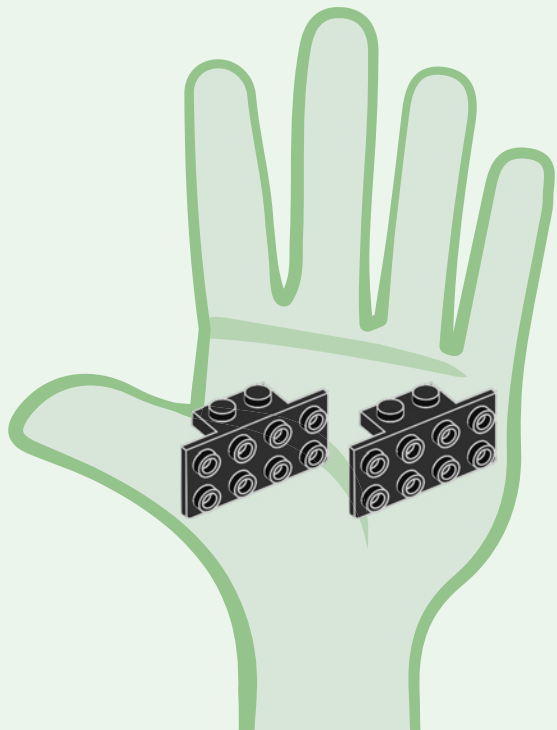

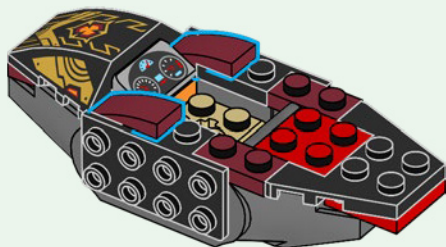
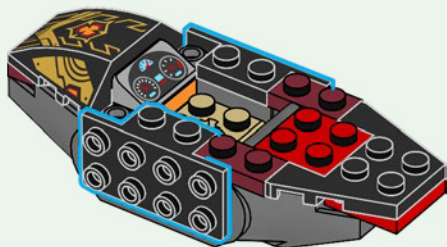

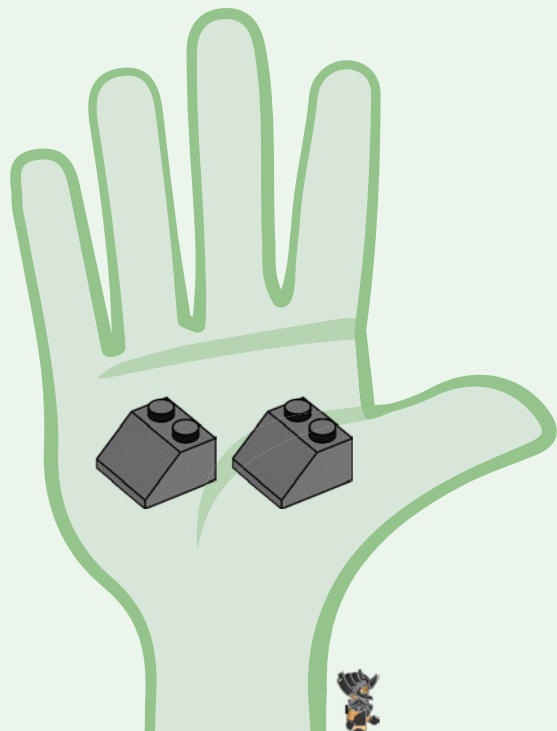
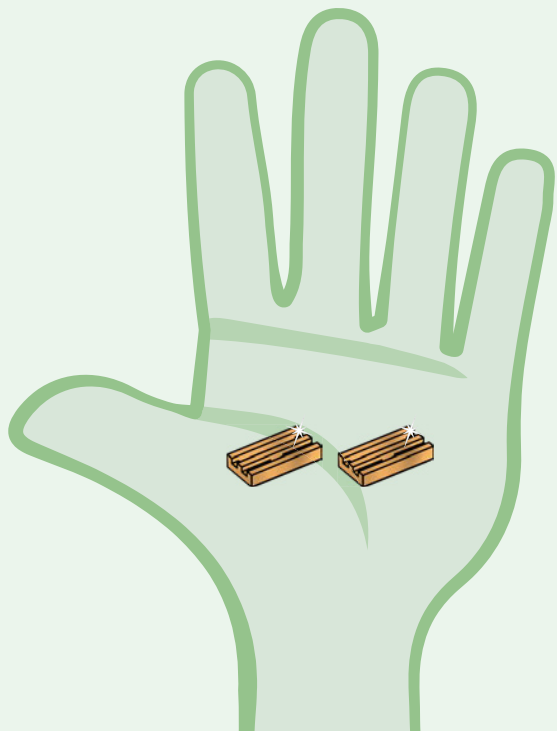

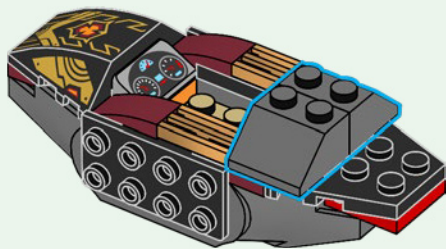
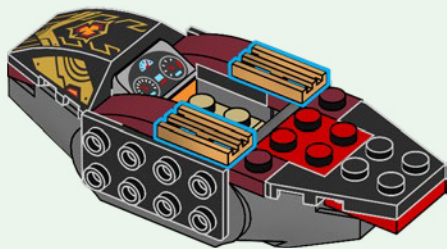

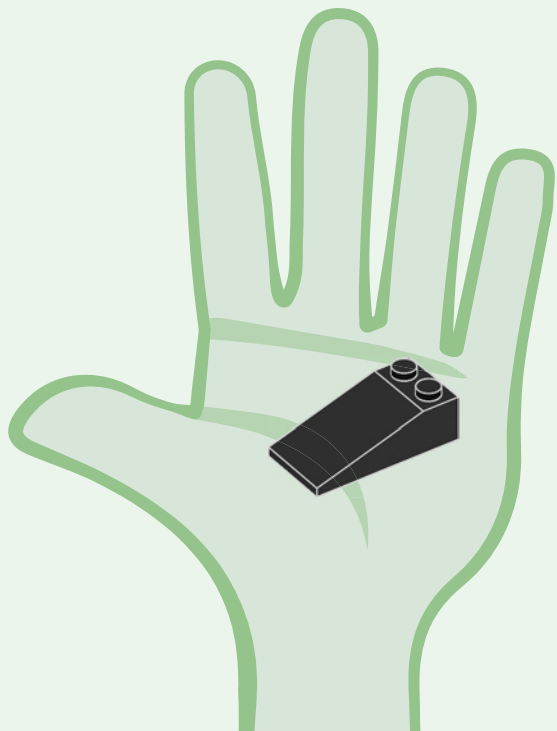

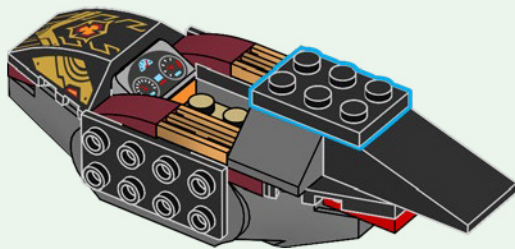
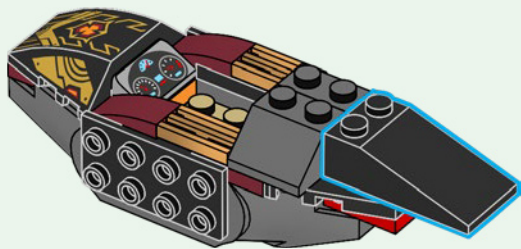

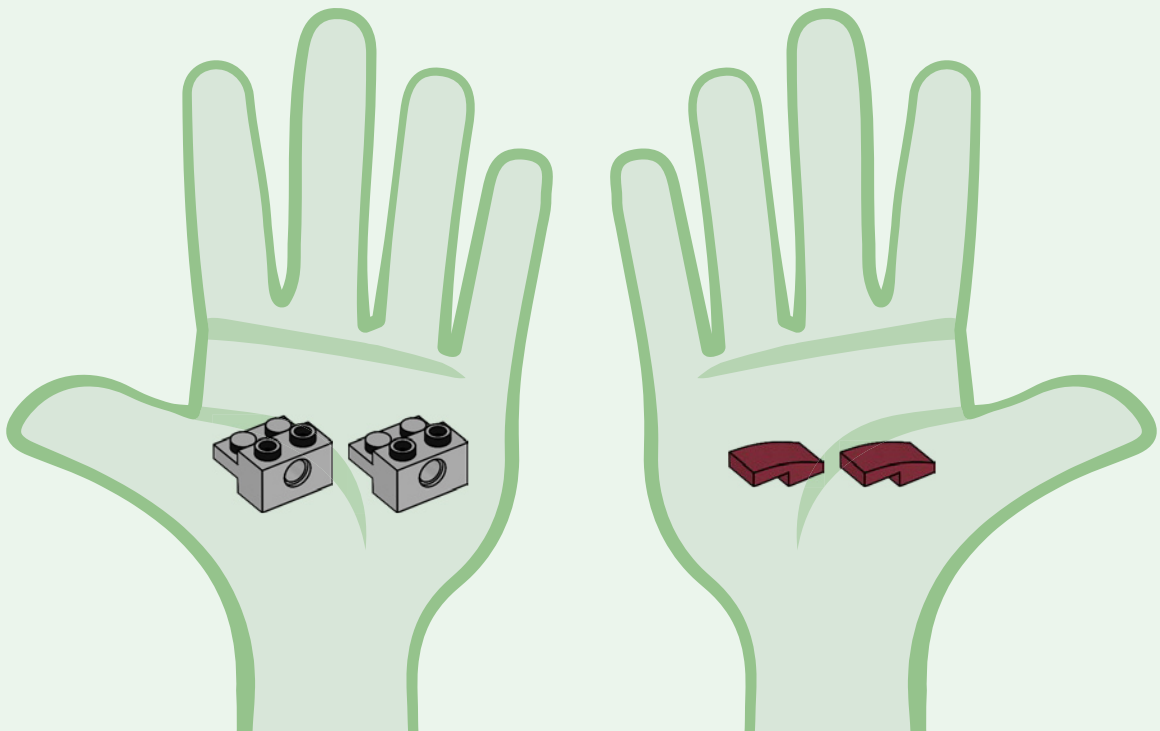

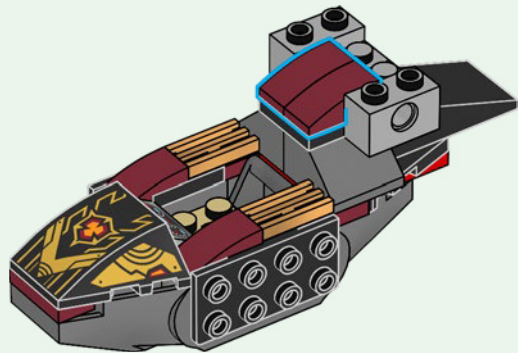
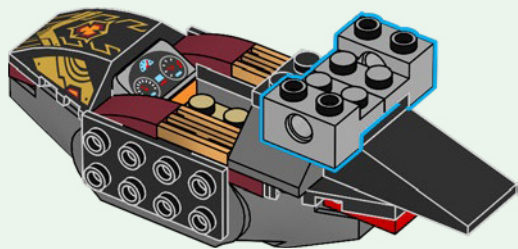

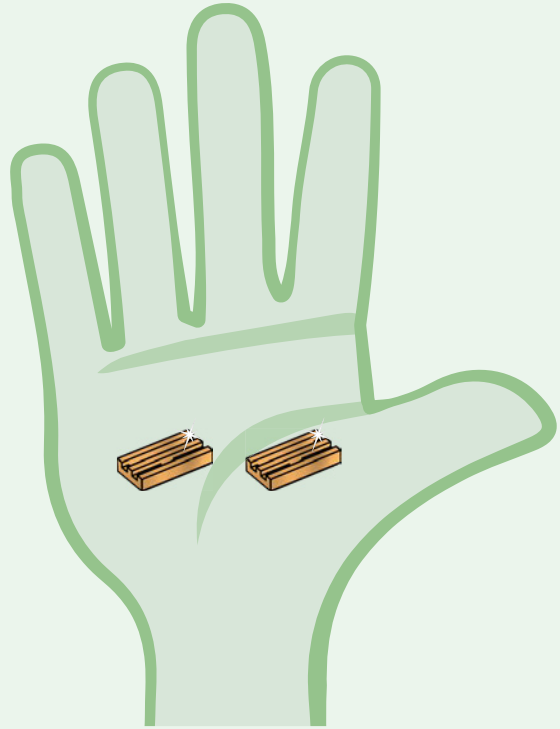
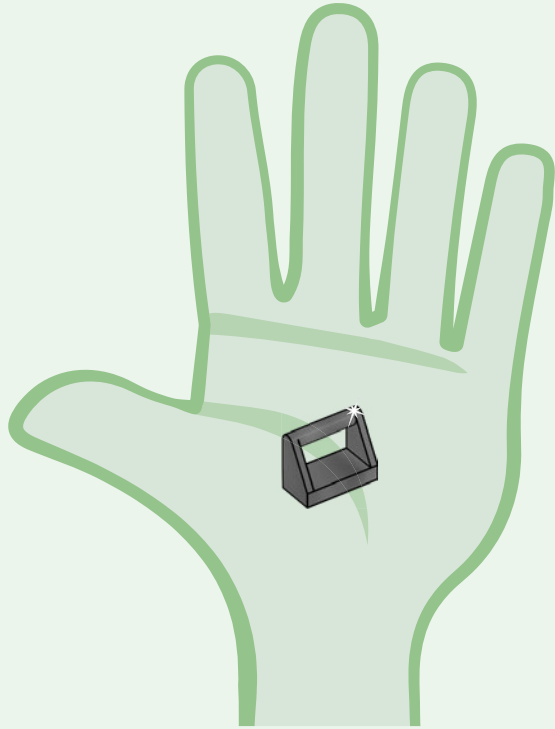

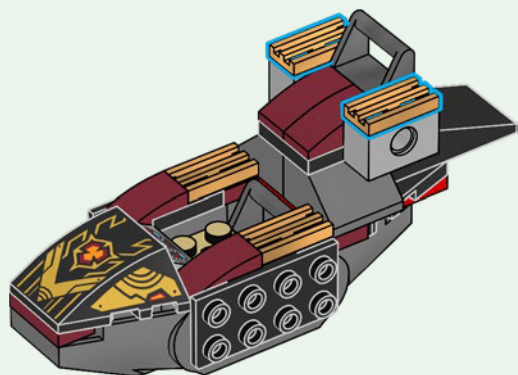
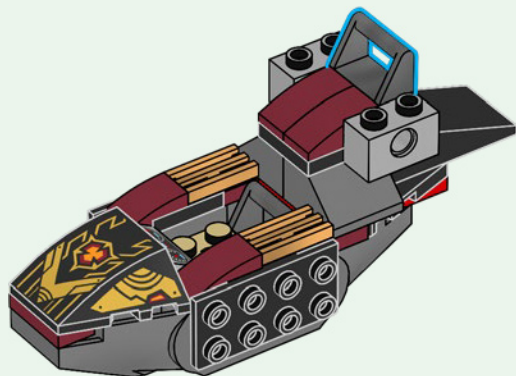

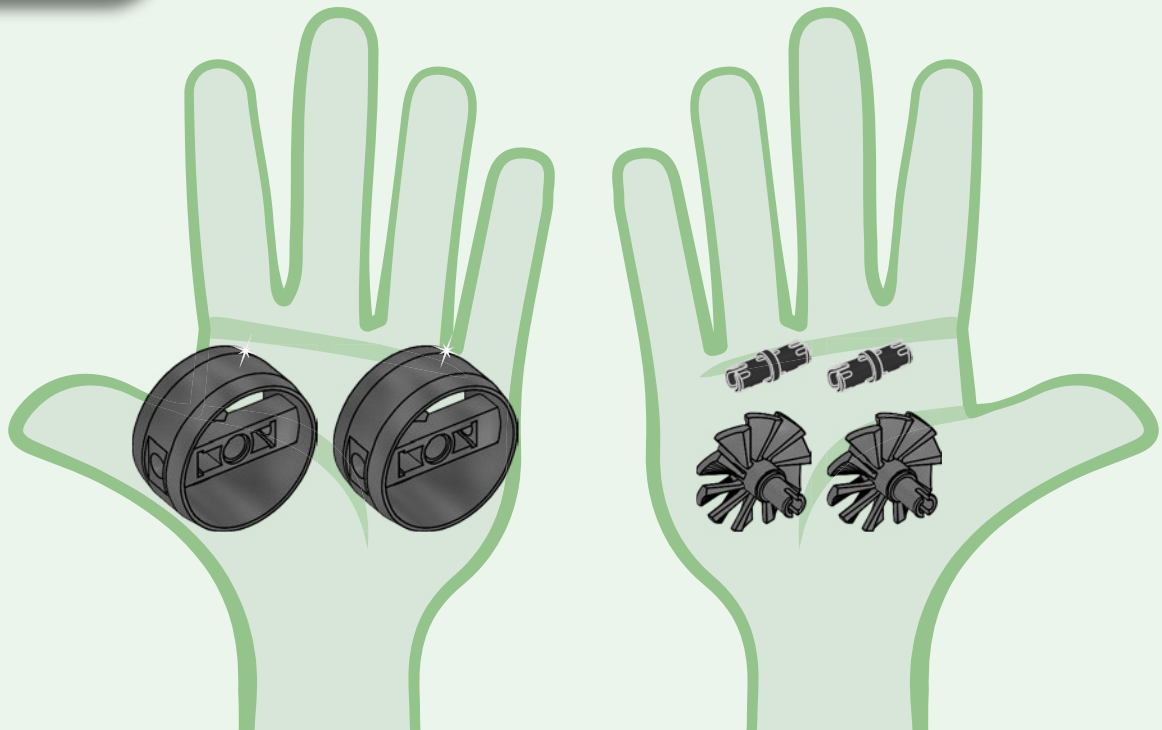

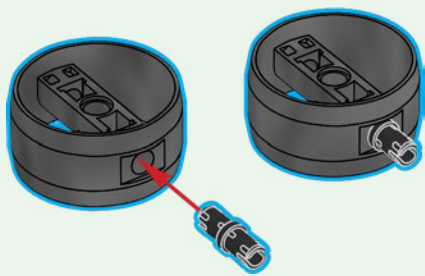



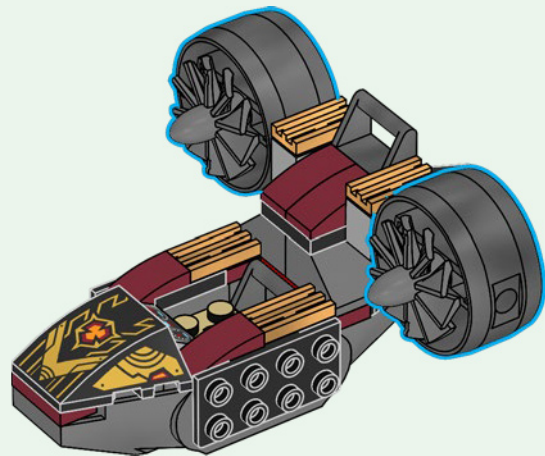

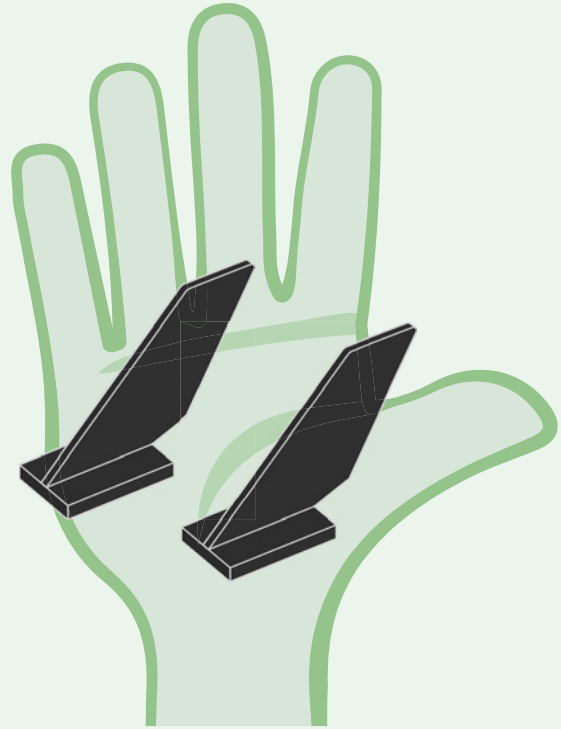

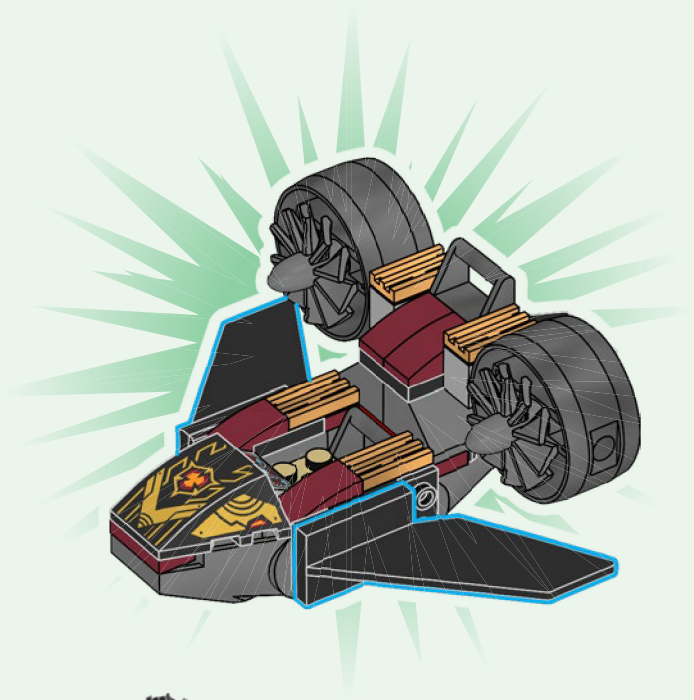

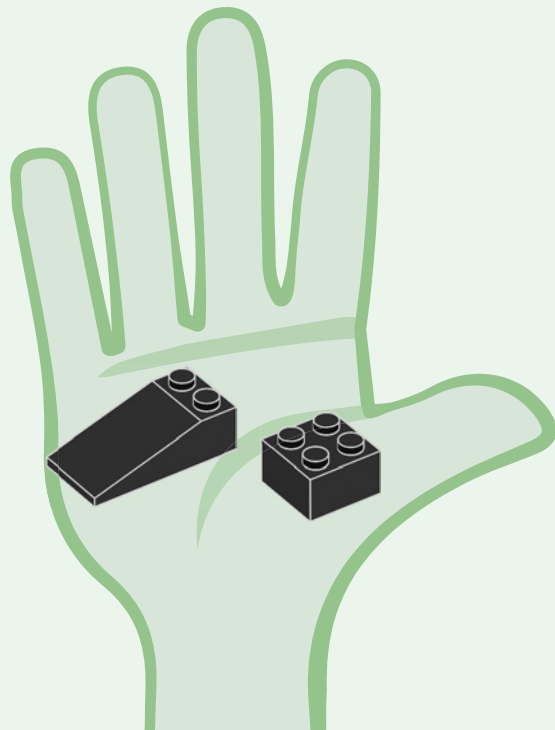
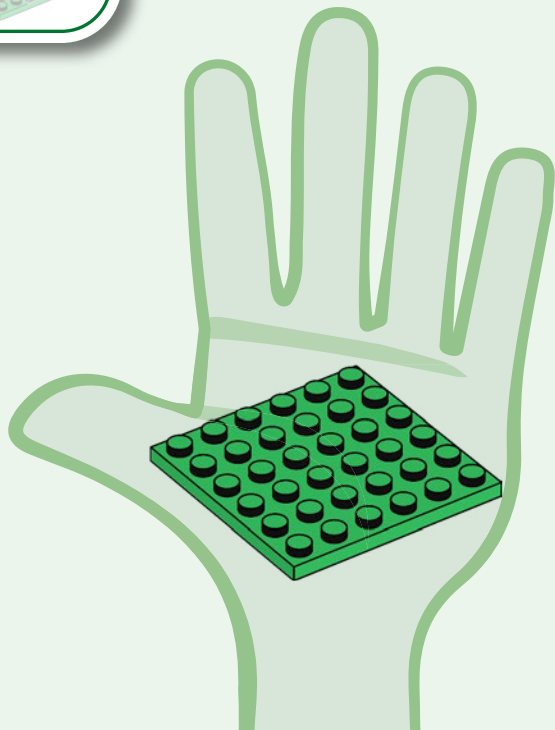

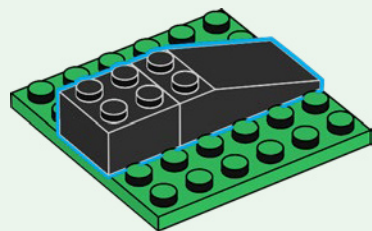
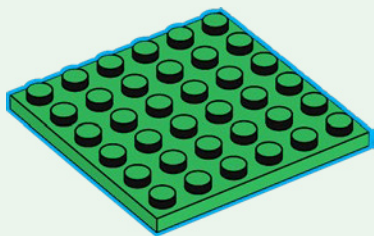

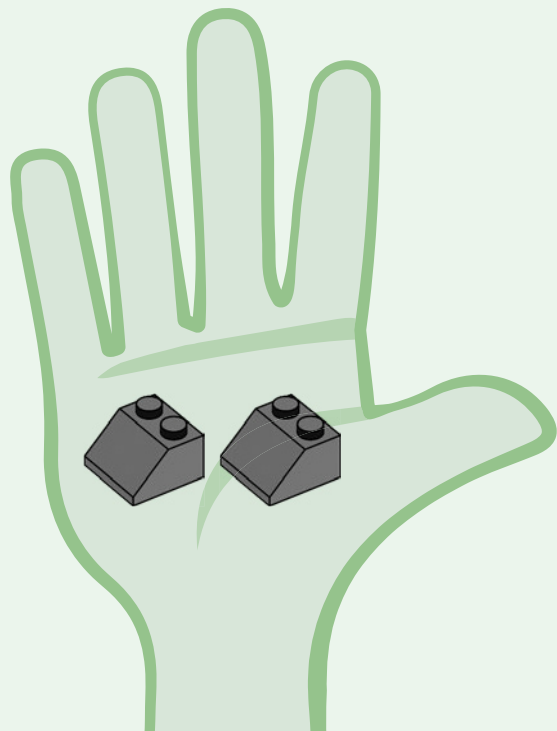
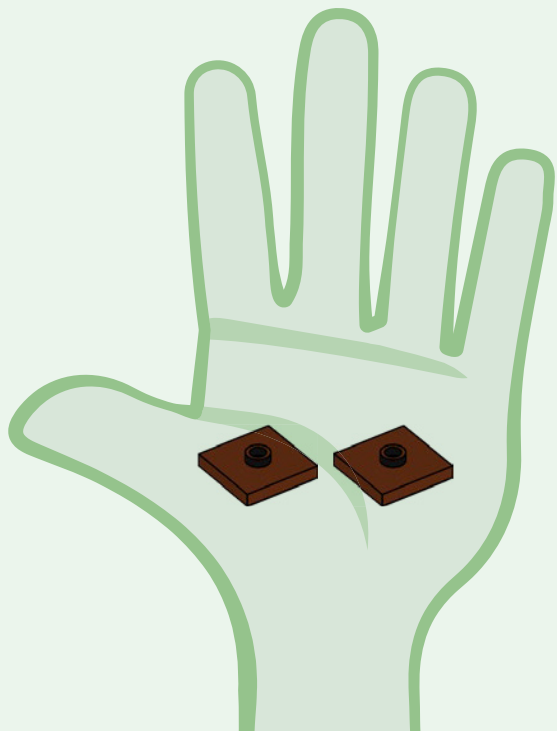

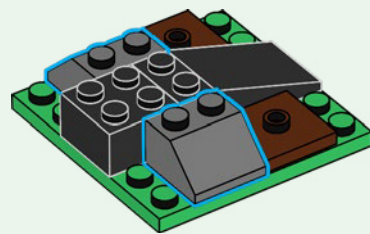
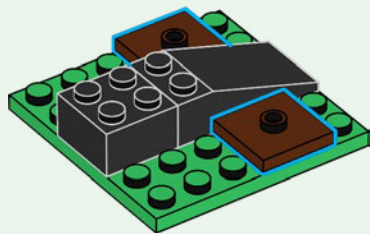

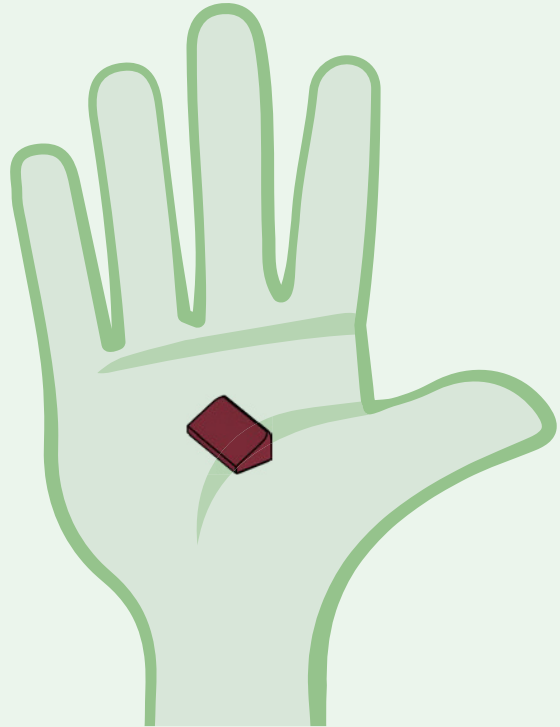
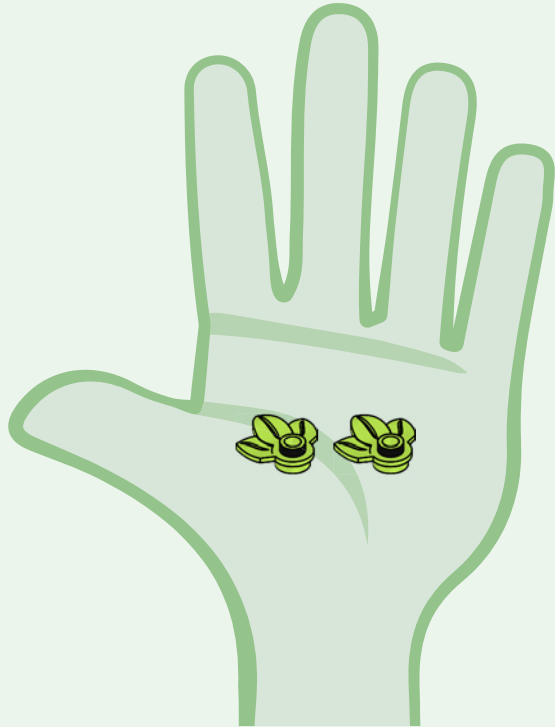

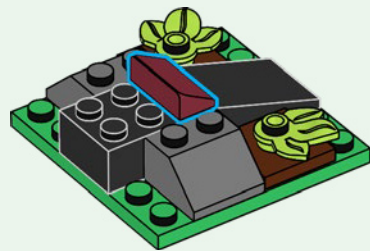
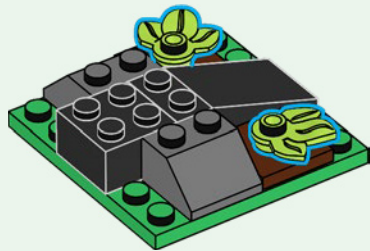

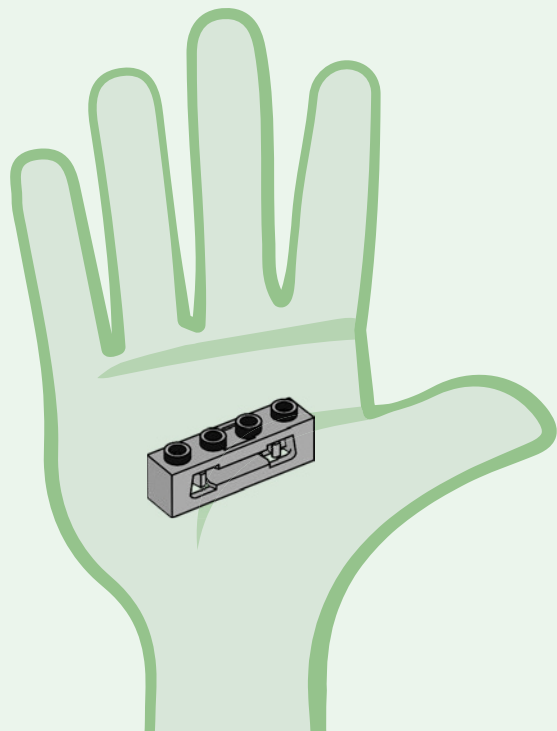
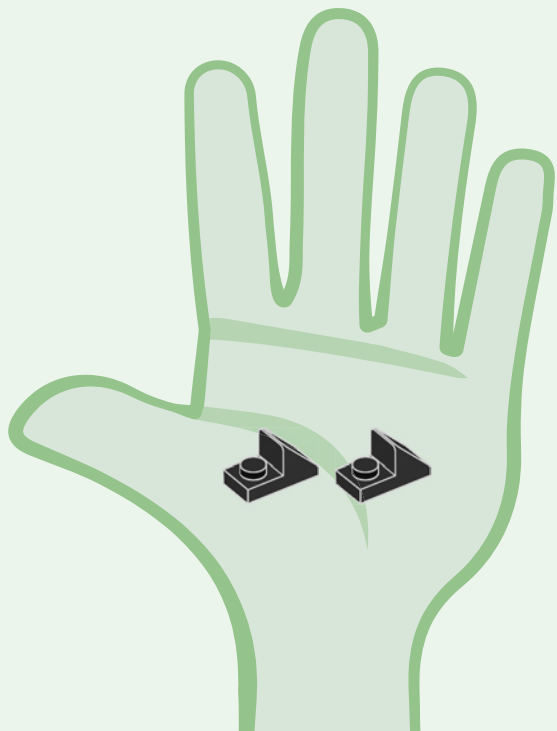

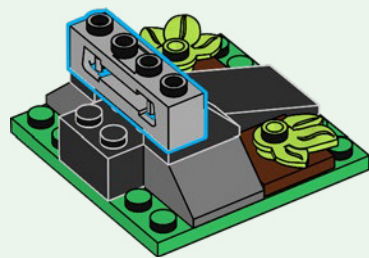
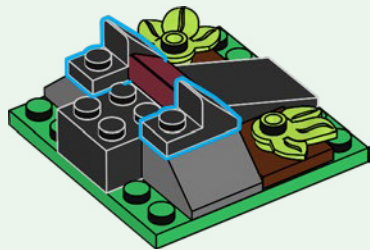

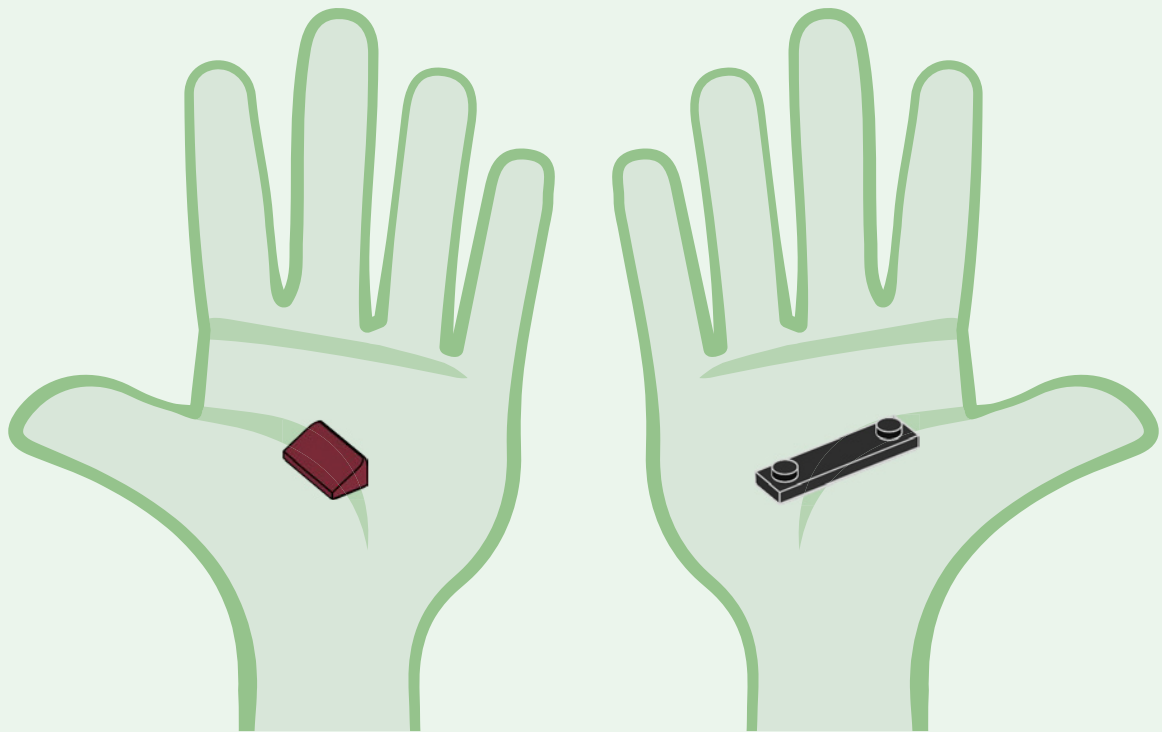

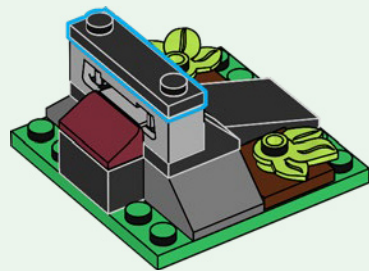
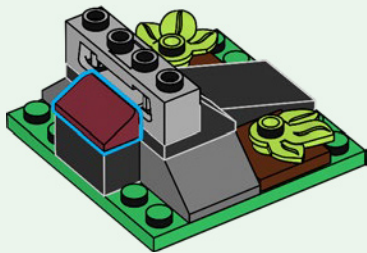

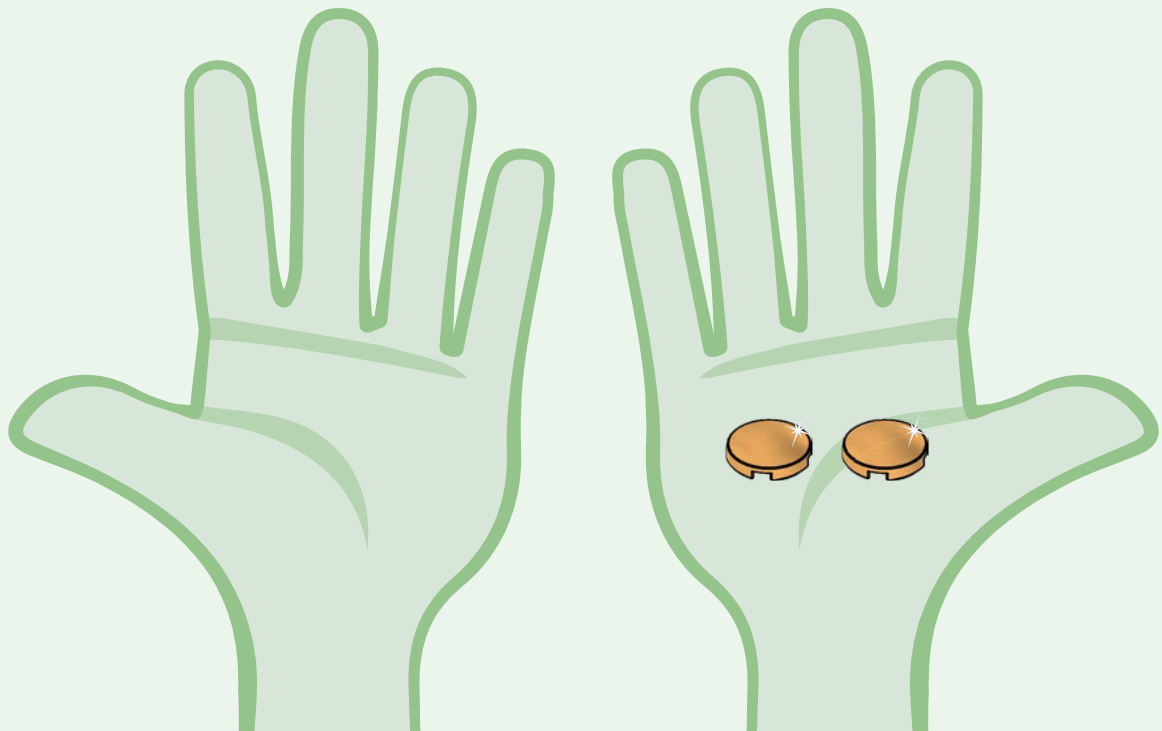

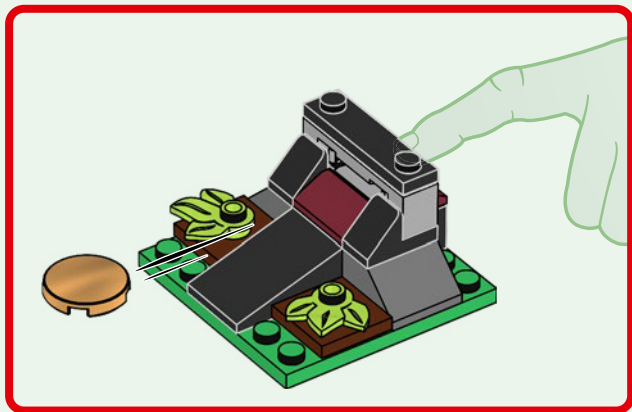
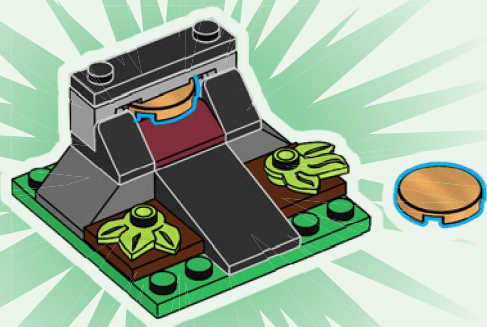

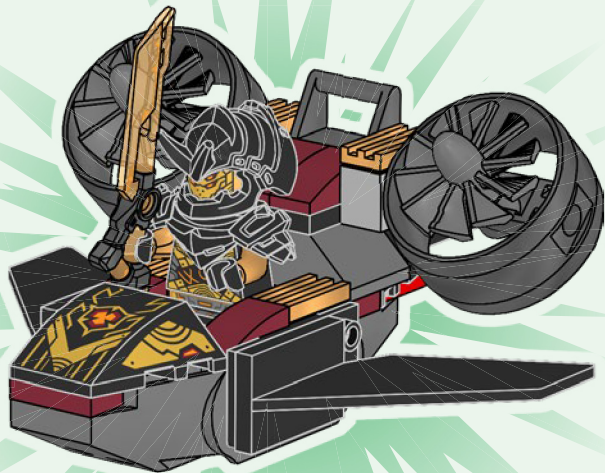
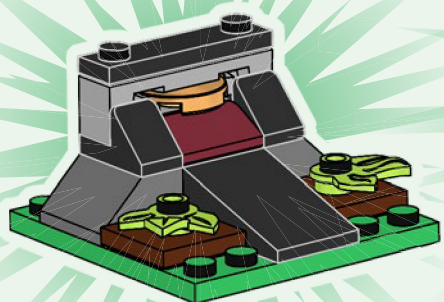





LEGO, the LEGO logo and NINJAGO are trademarks of the LEGO Group. ©2023 The LEGO Group. 6467007