

# BUSH

## Instruction manual

Tumble Dryer  
TDT17CN





You'll soon be enjoying your new tumble dryer.

It all begins here, with your instructions. Don't worry, there's nothing too technical coming up. Just simple, step-by-step guidance to get you up and running quickly. Sound good? Then let's get started.

## Help and Guidance

We're here to help you get the most from your tumble dryer. Should you require any guidance, a simple solution can often be found online at:

[www.bush-support.com](http://www.bush-support.com)

If you still require further assistance, call one of our experts on 0345 257 7271.

If you require any technical guidance or find that your product is not operating as intended, a simple solution can often be found in the Troubleshooting section of these instructions, or online at [www.bush-support.com](http://www.bush-support.com). If you still require further assistance, call one of our experts on 0345 257 7271.

# Contents

<b>1</b>	<b>Safety Information</b>		
	Safety information	6	
<b>2</b>	<b>Getting to know your tumble dryer</b>		
	Ready? Let's begin	10	
	Overview	11	
	<b>Installing your tumble dryer</b>		
<b>3</b>	<b>Correct Use</b>	14	
	Installing on top of a washing machine	15	
	Installation	16	
	Connection to Water Outlet (with optional drain hose) - Connecting the Water Discharge Hose		
	Electrical Connection	16	
<b>4</b>	<b>Functions</b>		
	Functions	17	
	Using The Tumble Dryer (Control Panel - Programme Selection Knob-Electronic Indicator and Additional Functions-Display)	18	
	Programme Seletion and Consumption	20	
	Table		
	Auxiliary Functions Starting the Programme	21	
	Programme Progress Drum light information	22	
<b>5</b>	<b>Using your tumble dryer</b>		
	Preparing The Laundry	25	
	Sorting the Laundry to be Dried		
	Preparing the Laundry to be Dried Load Capacity	26	
<b>6</b>	<b>Care and Maintenance</b>		
	Cleaning and Care	28	
	Cleaning the Lint Filter		
	Cleaning the Condenser		
	Cleaning the Humidity Sensor		
	Cleaning the Inner Surface of the Loading Door		
<b>7</b>	<b>Product support</b>		
	Troubleshooting	32	
	Automatic Fault Warnings and What To Do	33	
	Technical Specifications	34	
	Environmental Protection and Packing Information	35	
	Describing The Energy Label And Saving Energy Energy Efficiency	36	
	Product Fiche	37	
	Help And Asistance	38	
	Disposal	39	
	Guarantee	40	

# Safety information

1





## Safety information

Important - Please read these instructions fully before installing or operating your tumble dryer

### PRIMARY CONSIDERATIONS

This appliance can be used by children aged from 8 years and above and persons with reduced physical, sensory or mental capabilities or lack of experience and knowledge if they have been given supervision or instruction concerning use of the appliance in a safe way and understand the hazards involved. Children must not play with the appliance. Cleaning and user maintenance must not be made by children without supervision.

- Children of less than 3 years of age should be kept away from the appliance unless constantly supervised.
- This tumble dryer is intended only for household and indoor use. The warranty will be void in case of commercial use.
- Use this product only for laundry with a label that indicates it is suitable for drying.
- The manufacturer will not accept responsibility for damages resulting from incorrect use or transport.
- The service life time of your tumble dryer is 10 years. This is the period during which the spare parts required for the tumble dryer to operate properly will be commercially available.
- Do not allow floor coverings to obstruct the ventilation openings.
- Installation and repair of the machine should only be made by an authorised repair agent. The manufacturer cannot be held responsible for damages resulting from un-authorised repairs.
- The operating temperature of the dryer is +5°C to +35°C. If operated outside of this range, the performance of the dryer will be affected and the product may become damaged.
- Before installation, check the product for visible damage. Never install or operate a damaged product. Damaged products may endanger your health.
- Keep pets away from the dryer.
- Fabric softeners, or similar products, should be used in accordance with the manufacturers instructions.
- Remove all objects from pockets such as lighters and matches.
- The appliance must not be installed behind a lockable door, a sliding door or a door with a hinge on the opposite side to that of the tumble dryer, if it prevents the door from being fully opened.



**WARNING:** Never spray or pour water onto the dryer to wash it! There is risk of electric shock!

- Leave at least 3 cm of space between the side and rear walls of the product and above if you plan on placing your appliance under a worktop.
- Assembly / disassembly for under-counter installation if necessary must be done by an authorised service agent.

If you require any technical guidance or find that your product is not operating as intended, a simple solution can often be found in the Troubleshooting section of these instructions, or online at [www.bush-support.com](http://www.bush-support.com) If you still require further assistance, call one of our experts on 0345 257 7271.



## Safety information

Important - Please read these instructions fully before installing or operating your tumble dryer

### SAFETY INSTRUCTIONS

This section contains safety instructions that will help protect you from risk of personal injury or property damage. Failure to follow these instructions will void any warranty.

#### ELECTRICAL SAFETY

- The appliance must not be supplied through an external switching device, such as a timer, or connected to a circuit that is regularly switched on and off by a utility.
- Do not touch the power plug with wet hands. Always pull the plug to unplug the product, otherwise, there will be risk of an electric shock.
- Connect the dryer to a grounded socket with fuse protection. Have the earth connection installed by a qualified electrician. Our company cannot be held responsible for damages/losses resulting from using the dryer without an earth connection as required by local regulations.
- The voltage and the allowable fuse protection are indicated on the type plate. **(For the type plate, please see 3. Overview)**
- Voltage and frequency values indicated on the type plate must be equal to the mains voltage and frequency value in your house.
- Unplug the dryer when it is not used for an extended period and before installation, maintenance, cleaning and repair, otherwise, the dryer may become damaged.
- The plug socket must be freely accessible at all times after installation.

 **A damaged power cord/plug can cause fire or give you an electric shock. When damaged, it must be replaced by qualified personnel only.**

 **To avoid the risk of fire or electric shock, do not use extension cords, multi sockets or adapters to connect the dryer to mains power.**

#### CHILDREN'S SAFETY

- This appliance is not intended for use by persons (including children) with reduced physical, sensory or mental capabilities, or lack of experience and knowledge, unless they have been given supervision or instruction concerning use of the appliance by a person responsible for their safety.
- This appliance can be used by children aged from 8 years and above and persons with reduced physical, sensory or mental capabilities or lack of experience and knowledge if they have been given supervision or instruction concerning use of the appliance in a safe way and understand the hazards involved. Children must not play with the appliance. Cleaning and user maintenance must not be made by children without supervision.
- Children less than 3 years old should be kept away from the machine unless continuously supervised.
- Do not leave children unattended near the machine.
- Children might lock themselves in the machine resulting in risk of serious injury or possible death.
- Do not allow children to touch the door during operation. The surface becomes extremely hot and may cause serious injury.
- Keep packaging material away from children.
- Poisoning and irritation may occur if detergent and cleaning materials are consumed or come into contact with the skin and eyes.
- Keep cleaning materials out of the reach of children. Electrical products are dangerous for children.
- Keep children away from the product while it is running.
- To prevent children from interrupting the dryer cycle, you can use the child lock to avoid any changes in the running programme.
- Do not allow children to sit/climb on or climb inside the product.



## Safety information

Important - Please read these instructions fully before installing or operating your tumble dryer

### PRODUCT SAFETY



Due to risk of fire, the following laundry items and products should NEVER be dried in the dryer:

- Do not dry unwashed items in the tumble dryer.
- Items that have been soiled with substances such as cooking oil, acetone, alcohol, petrol, kerosene, spot removers, turpentine, waxes and wax removers should be washed in hot water with an extra amount of detergent before being dried in the tumble dryer.
- Cleaning cloths and mats that have residues of flammable cleaning agents or acetone, gas, petrol, stain remover, turpentine, candle, wax, wax remover or chemicals.
- Laundry that has residues of hair sprays, nail polish remover and similar substances.
- Laundry on which industrial chemicals have been used for cleaning (such as chemical cleaning).
- Laundry that has any kind of foam, sponge, rubber or rubber-like parts or accessories. These include latex foam sponge, shower caps, waterproof fabrics, fitted clothes and foam pillows.
- Items with filling and damaged items (pillows or jackets). Foam protruding from these items might catch fire during the drying process.
- Operating the dryer in environments that contain flour or coal dust may cause explosion.



**ATTENTION: Underwear that contain metal reinforcements should not be put in the dryer. The dryer may be damaged if metal reinforcements come loose and break off during drying.**

**Do not attempt to repair the appliance yourself. Contact the manufacturer, their approved service agent or the Customer Helpline: 0345 257 7271.**

# Getting to know your tumble dryer

# 2





# Getting to know your tumble dryer

You'll be up and running in no time

Ready? Let's begin...

Please read these instructions carefully. They contain important information which will help you get the best from your tumble dryer and ensure safe and correct installation and operation.

If you require any further assistance, our technical experts are happy to help. For full details, refer to the product support section at the end of these instructions.

# Getting to know your tumble dryer

You'll be up and running in no time

## OVERVIEW

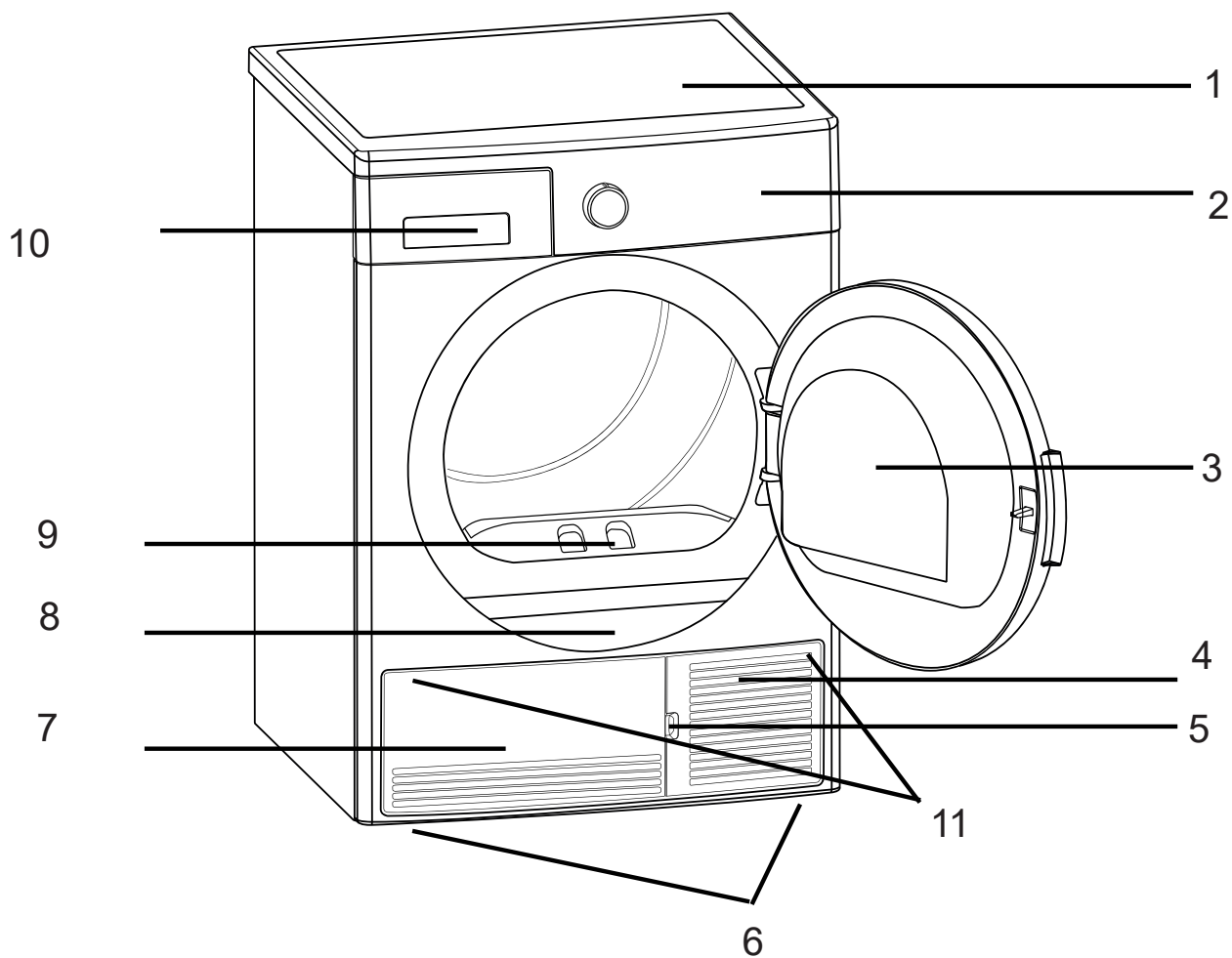

- |                        |                        |
|------------------------|------------------------|
| 1. Upper tray          | 7. Plinth cover        |
| 2. Control panel       | 8. Type plate          |
| 3. Loading door        | 9. Lint filter         |
| 4. Plinth opening slot | 10. Drawer Cover       |
| 5. Plinth              | 11. Ventilation grills |
| 6. Adjustable feet     |                        |

If you require any technical guidance or find that your product is not operating as intended, a simple solution can often be found in the Troubleshooting section of these instructions, or online at [www.bush-support.com](http://www.bush-support.com) If you still require further assistance, call one of our experts on 0345 257 7271.

Model	Capacity	Energy class
TDT17CN	7kg	B

If you require any technical guidance or find that your product is not operating as intended, a simple solution can often be found in the Troubleshooting section of these instructions, or online at [www.bush-support.com](http://www.bush-support.com) If you still require further assistance, call one of our experts on 0345 257 7271.

# Installing your tumble dryer

# 3



# Installing your tumble dryer

## Bringing it all together

### CORRECT USE

 **ATTENTION:** Never stop a tumble dryer before the end of the drying cycle unless all items are quickly removed and spread out so that the heat is dissipated.

 **ATTENTION:** Make sure that pets do not enter the dryer. Check the inside of the dryer before using it.

 **ATTENTION:** Superheating of clothes inside of the dryer can occur if you cancel the programme or in the event of a power failure whilst the dryer is running. This concentration of heat can cause self-combustion so always activate the Refresh programme to cool down or quickly remove all laundry from the dryer in order to hang them up and dissipate the heat.

- Use the dryer only for household drying and to dry fabrics with a label that indicates they are suitable for drying. All other uses are out of the scope of intended use and are prohibited.
- The warranty will be void in case of any commercial use.
- This appliance is designed to be used inside domestic residences only, and should be placed on a straight and stable surface.
- Do not lean against or sit on the door of the dryer. The dryer may tip over.
- To maintain a temperature that will not harm the laundry (e.g. to prevent the laundry from catching fire), a cooling process starts after the heating process. After this, the programme ends. At the end of the programme, always remove the laundry promptly.

 **ATTENTION:** Never use the dryer without a lint filter or with a damaged lint filter.

- Lint filters must be cleaned **after each use** as indicated in **Cleaning the Lint Filter** Section.
- Lint filters must be dried after wet cleaning. Wet filters might cause malfunction during the drying process.
- Lint accumulation must not to be allowed around the tumble dryer (not applicable for appliances intended to be vented to the exterior of the building)

 **IMPORTANT:** The clearance between the dryer and the floor should not be reduced with objects such as carpets, wood or panels. In these instances, sufficient air intake cannot be ensured for the machine.

- Do not install the dryer in rooms where there is a risk of freezing. Freezing temperatures negatively affect the dryers performance. Condensed water that freezes in the pump and hose may cause damage.

## INSTALLING ON TOP OF A WASHING MACHINE

 **ATTENTION:** A washing machine cannot be placed on the dryer. Pay attention to the warnings below when installing the dryer on a washing machine.

 **ATTENTION:** The dryer can only be placed on washing machines that have the same capacity and above..

- To use the dryer on the washing machine, a fixing part must be used between the two products. The fixing part must be attached by an Authorised Service Provider.
- When the dryer is placed on the washing machine, the total weight of these products may reach almost 150 kilograms (when loaded). **Place the products on a solid floor that has a load bearing capacity!**

Appropriate Installation Table for Washing Machine and Tumble Dryer					
Tumble Dryer (Depth)	Washing Machine				
	37-41cm	42-45cm	46-49cm	50-56cm	57-63cm
52.5 cm	X	✓	✓	✓	✓
56 cm	X	X	✓	✓	✓
61 cm	X	X	X	✓	✓
64 cm	X	X	X	X	✓

(For the depth information, please see 7. Technical Specifications)

In order to put the washing machine onto the dryer, a special stacking kit is required as an optional extra. Please contact customer service to acquire. The assembly instruction will be served together with the stacking kit

### CE Declaration of conformity

We declare that our products meet the applicable European Directives, Decisions and Regulations and the requirements listed in the standards referenced.

### Disposing the Old Product

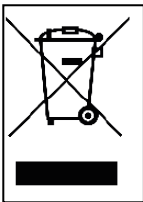

This product complies with EU WEEE Directive (2012/19/EU). This product bears a classification symbol for waste electrical and electronic equipment (WEEE).

This symbol, which is found on the product or information label, indicates that this product must not be disposed together with other household waste at the end of its service life. To prevent the potential harm of uncontrolled waste disposal on the environment and human health, please keep this product separate from other types of waste, and to prevent sustainable reuse of material resources, make sure that it is recycled responsibly.

Contact your dealer or local authorities to get information on how and where you can take the product for environmentally-safe recycling. This product cannot be mixed with other commercial wastes for recycling.

# Installing your tumble dryer

## Bringing it all together

### INSTALLATION

- Before contacting the local Authorised Service Provider for the installation of the dryer, check the information in the user manual to make sure that the electrical installation and water outlet is suitable. If they are not, call a qualified electrician and a plumber to have the necessary adjustments made.
- It is the customer's responsibility to prepare the dryer's installation place, as well as the electricity and waste water installation. Before installation, check the dryer for damage. If damaged, do not have it installed. Damaged products may endanger your health.
- Install the dryer on a stable and flat surface.
- Run the dryer in a dust-free environment where the air ventilation is good.
- The clearance between the dryer and the floor **should not be** reduced with objects such as carpets, wood or tape.
- **Do not block the ventilation grills** found on the plinth of the tumble dryer.
- The appliance must not be installed behind a lockable door, a sliding door or a door with a hinge on the opposite side of the tumble dryer, in such a way that blocks the full opening of the tumble dryer door.
- Once the dryer has been installed, the connections must remain stable. When installing the dryer, make sure that the rear surface is not leaning on anything (e.g. tap, socket).
- The operating temperature of the dryer is +5°C to +35°C. If operated out of this temperature range, the performance of the dryer will be affected negatively and the product will be damaged.
- Be careful when carrying the product since it is heavy. Always wear safety gloves.
- The rear surface of the product should be placed against the wall.
- When the product is placed on a stable surface, use the water level to check if it is fully stable. If not, adjust the feet until it becomes steady. Repeat this process every time you relocate the product.

- Do not place the dryer onto the power cable.

### ADJUSTING THE FEET

- For the dryer to work with less noise and vibration, it must be stable and balanced on its feet. Adjust the feet to ensure that the product is balanced.
- Rotate the feet to the right and to the left until the dryer is even and stable.



**IMPORTANT:** Never remove the adjustable feet.

### ELECTRICAL CONNECTION



**ATTENTION:** There is risk of fire and electric shock.

- Your dryer is set to 220-240 V and 50 Hz.
- The mains cable of the dryer is equipped with a special plug. This plug must be connected to an earthed socket protected by a fuse of 13 Amperes as indicated on the type plate. The fuse current rating of the power line where the outlet is connected must also be 13 amperes. Consult a qualified electrician if you do not have such an outlet or fuse.
- Our company cannot be held responsible for damages resulting from usage without earthing.



**IMPORTANT:** Operating your machine at low voltage values will shorten the service life and decrease the performance of your machine.

### UNDER COUNTER INSTALLATION

- Leave at least 3 cm of space between the side and rear walls of the product and the underside of the worktop when installing your product under a counter.
- Assembly / disassembly under the counter if necessary must be done by authorised service.

If you require any technical guidance or find that your product is not operating as intended, a simple solution can often be found in the Troubleshooting section of these instructions, or online at [www.bush-support.com](http://www.bush-support.com) If you still require further assistance, call one of our experts on 0345 257 7271.

# Functions 4





# Functions

## Simple everyday use

### USING THE TUMBLE DRYER

#### CONTROL PANEL

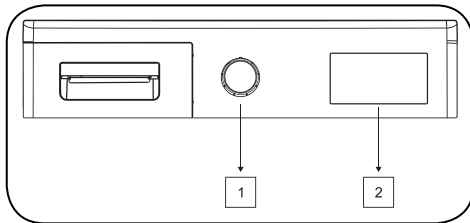

1. Programme Selection Knob
2. Electronic indicator and additional functions

#### Programme Selection Knob

Use the programme selection knob to select the desired drying programme

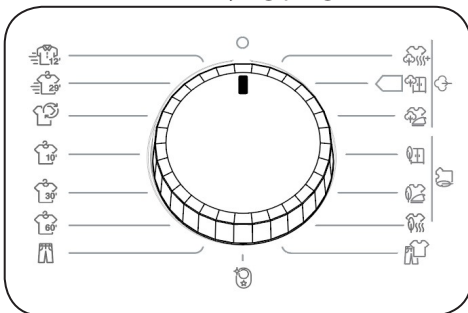

### ELECTRONIC INDICATOR AND ADDITIONAL FUNCTIONS

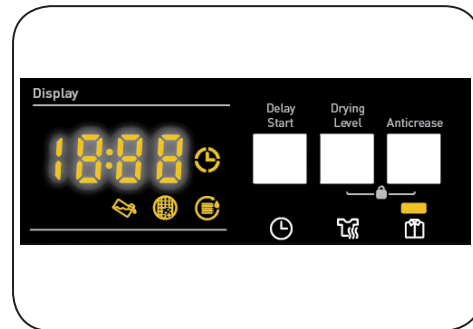

#### Display symbols:

Water tank warning indicator	
Lint filter cleaning warning indicator	
Condenser cleaning warning indicator	

# Functions

## Simple everyday use

### PROGRAMME SELECTION AND CONSUMPTION TABLE

Press the Start/Pause button to start the programme. The Start/Pause LED that indicates that the programme has started and the Drying LED will come on.

Programme	Load (kg)	Tumble dryer spin speed	Approximate amount of remaining humidity	Duration (minutes)
Cotton Extra Dry	7	1000	60%	143
Cotton Cupboard Dry	7	1000	60%	125
Cotton Iron Dry	7	1000	60%	106
Synthetics Cupboard Dry	3,5	800	40%	51
Synthetics Iron Dry	3,5	800	40%	37
Delicates	2	600	50%	46
Mix	4	1000	60%	92
Baby Care	3	1000	60%	66
Jeans	4	1000	60%	91
60 min	-	-	-	60
30 min	-	-	-	30
10 min	-	-	-	10
Refresh	-	-	-	10
Express 29'	1	1200	50%	29
Shirts 12'	0,5	1200	50%	12

Energy consumption values				
Programme	Load (kg)	Tumble dryer spin speed	Approximate amount of remaining humidity	Energy consumption values (kWh)
Cotton Cupboard Dry	7	1000	60%	4.18
Cotton Iron Dry	7	1000	60%	3.40
Synthetics Cupboard Dry	3,5	800	40%	1.42
Power consumption in the "off mode" $P_o$ (W)				0.5
Power consumption in the "on mode" $P_L$ (W)				1.0

 The Cotton Cupboard Dry programme is the standard drying programme that can be run with a full or half load and for which the information is given on the label and product receipt. This programme is the most energy efficient programme to dry normal wet cotton clothes.

\*Energy labelling standard programme (EN 61121:2013)

All values in the table were determined in accordance with the EN 61121:2013 standard. Consumption values may vary from the values in the table depending on the fabric type, spin speed, environment conditions and voltage values.

## AUXILIARY FUNCTIONS

Option	Description
Drying Level	The dampness level obtained after drying can be increased by another 3 levels in addition to the standard setting. This way, it is ensured that the laundry is drier. Levels that can be selected apart from the standard setting (Level 1) are 2 (low), 3 (Medium) or 4 (High). After selection, the light of the relevant drying level turns on.
Anti-Crease	If you select the Anti-Crease option and do not open the door of the dryer at the end of the programme, the 1 hour Anti-crease phase will extend to 2 hours. After selecting the Anti-Crease option, you will hear an audible warning. You can press the same button again to cancel the option. If you open the door or press the Start/Pause key while Anti-Crease is in progress, the process will be cancelled.
Delay Start	You can delay the start time of the programme by selecting the 3 hour, 6 hour or 9 hour delay option. You can activate the desired delay time by pressing the Start/Pause button. When the time is up, the selected programme will start automatically. During the delay time, options compatible with the programme can be activated/deactivated.
Buzzer Cancel	The dryer gives an audible warning when program selection knob is turned, buttons are pressed and at the end of programme. To cancel these warnings, press and hold the "Anti-Crease" button for 3 seconds. When you press the button, you will hear an audible warning that the option has been cancelled.
Child Lock	There is a child lock option to avoid changes in the programme flow when keys are pressed during the programme. To activate the child lock feature, user should press the "Drying Level" and "Anti-Crease" buttons simultaneously for 3 seconds. When the child lock is activated or deactivated, "CL" is shown on the display for 2 seconds, an audible warning is heard and all functions & keys will be locked. If Programme selection is changed while child lock is active, an audible warning will be heard and the "CL" will be shown on the display. The child lock is not automatically deactivated at the end of the programme or when the programme selection knob is set to the "Off" position. To deactivate the child lock, push the "Drying Level" and "Anti-Crease" buttons for 3 secs when the programme has finished. Note – If the programme selection is changed while the product is running and the child lock is active, the programme will continue unchanged, "CL" will be displayed for 2 seconds and an audible warning will be heard. To select a new programme, the child lock must be deactivated first and then the desired programme selected. If "CL" appears on the display and alarm is heard when trying to select a programme or function, please press and hold the "Drying Level " and "Anti-Crease" buttons for 3 seconds to deactivate the child lock and try again.

# Functions

## Simple everyday use

### STARTING THE PROGRAMME

The Start/Pause LED will flash during programme selection. Press the Start/Pause button to start the programme. The Start/Pause LED that indicates that the programme has started and the drying LED will come on.

Programme	Description
Cotton Extra Dry	This programme dries thick and multi-layer fabrics, such as cotton towels, bedsheets, pillowcases, bathrobes, at a high temperature to allow you to place them in a closet.
Cotton Cupboard Dry	This programme dries cotton pyjamas, underwear, tablecloths etc. to allow you to place them in a closet.
Cotton Iron Dry	This programme dries cotton laundry to prepare it for ironing. Laundry removed from the machine will be damp.
Synthetics Cupboard Dry	This programme dries synthetics, such as shirts, t-shirts, blouses, at a lower temperature compared to the cottons programme to allow you to place them in a closet.
Synthetics Iron Dry	This programme dries synthetics, such as shirts, t-shirts, blouses, at a lower temperature compared to the cottons programme to prepare them for ironing. Laundry removed from the machine will be damp.
Delicate	This programme dries thin clothes like shirts, blouses and silk garments at a low temperature to make them ready to wear.
Mix	This programme dries cotton-synthetic mixed garments that do not discolour to make them ready to wear.
Baby Care	This programme dries delicate infant clothes at a low temperature to make them ready to wear.
Jeans	This programme is used to dry jeans.
Time Programmes	To reach the required drying level at a low temperature, you can use the timed programmes of 10 min., 30 min., and 60 min. Regardless of the drying level, the programme stops at the desired time.
Refresh	This programme provides ventilation for 10 minutes without applying heat to help freshen up your garments.
Express 29'	1 kg of cotton shirts spun at a high speed in the washing machine are dried in 29 minutes.
Shirts 12'	2 to 3 shirts are ready for to be ironed in 12 minutes.

 **IMPORTANT:** Do not open the loading door while the programme is running. If you have to open the door, do not keep it open for a long time.

# Functions

## Simple everyday use

### Selection Stand By

After 15 minutes without user action in selection mode, machine goes to energy-saving mode due to decrease energy consumption. In this model, "---" must blink for 0,5 sec ON, 3 sec OFF during energy saving mode. When energy saving mode is active, the brightness of "---" shown on the display is lowered to conserve energy. To restart the machine, the programme dial must be turned to the "OFF" position and a new programme selected.



### During the Programme

If you open the door when the programme is running, the product will switch to standby mode. Once the door has been closed, press the Start/Pause key to resume the programme.

Do not open the loading door when the programme is running. If you have to open the door, do not keep it open for a long time.

### Programme End

Once the programme is over, the warning LEDs for Start/Pause, water tank level, filter cleaning and condenser cleaning will turn on. Additionally, an audible warning will be given at the end of the programme. You can remove the laundry to make the machine ready for a new load.

-  **IMPORTANT:** Clean the lint filter after every programme. Empty the water tank after every programme.
-  **IMPORTANT:** If you do not take out the laundry after the programme has ended, the 1-hour Anti Crease phase will automatically be activated. This programme rotates the drum at regular intervals to prevent creases.

### DRUM LIGHT INFORMATION

- This product includes LED Drum Light. The light works automatically when you open the door and turns itself off automatically after a while.
- It is not an adjustable option for user to open or close it.
- Please do not try to replace or modify the LED Light.

# Functions

## Simple everyday use

PROGRAMMES	OPTIONS				
	Delay Start	Buzzer Cancel	Child Lock	Drying Level	Anticrease
Cotton Extra Dry	✓	✓	✓	✓	✓
Cotton Cupboard Dry	✓	✓	✓	✓	✓
Cotton Iron Dry	✓	✓	✓	✓	✓
Synthetics Cupboard Dry	✓	✓	✓	✓	✓
Synthetics Iron Dry	✓	✓	✓	✓	✓
Delicate	✓	✓	✓	x	✓
Mix	✓	✓	✓	✓	✓
Baby Care	✓	✓	✓	✓	✓
Jeans	✓	✓	✓	✓	✓
60 min	✓	✓	✓	x	✓
30 min	✓	✓	✓	x	✓
10 min	✓	✓	✓	x	✓
Refresh	✓	✓	✓	x	✓
Express 29'	✓	✓	✓	x	✓
Shirts 12'	✓	✓	✓	x	✓
X	Not selectable				
✓	Selectable				

If you require any technical guidance or find that your product is not operating as intended, a simple solution can often be found in the Troubleshooting section of these instructions, or online at [www.bush-support.com](http://www.bush-support.com) If you still require further assistance, call one of our experts on 0345 257 7271.

# Using your tumble dryer **5**



# Using your tumble dryer

















## Getting the most from your appliance

### PREPARING THE LAUNDRY

#### SORTING THE LAUNDRY TO BE DRIED

Follow the instructions on the labels of the laundry to be dried. Only dry items that have a statement/ symbol that indicates "they can be dried in a dryer".

- Do not operate the product with load amounts and laundry types other than those given in 4.3. Load Capacity.

 Suitable for drying in a dryer	 Does not need ironing	 Sensitive/Delicate drying	 Not suitable for drying in a dryer
 No drying	 Do not dry-clean	 At any temperature	 At high temperatures
 At medium temperatures	 At low temperatures	 Heatless	 Hang to dry
 Spread to dry	 Hang wet to dry	 Spread in shadow to dry	 Suitable for dry cleaning

Do not dry thin, multi-layer or thick-layer fabrics together as they dry at different levels. For this reason, dry clothes together that have the same structure and fabric type. This way, you can get an even drying result. If you think that the laundry is still wet, you can select a time programme for additional drying.

Please dry your big (like duvets) and small pieces of laundry separately in order to not to have damp laundry.

**🚫 IMPORTANT:** Delicate fabrics, embroidered fabrics, woolen/silk fabrics, clothes made of delicate and expensive fabrics, airtight clothes and tulle curtains are not suitable for drying in the dryer.



# Using your tumble dryer

## Getting the most from your appliance

### PREPARING THE LAUNDRY TO BE DRIED

#### Risk of explosion and fire!

Remove all objects from pockets such as lighters and matches.

 **ATTENTION:** The drum of the dryer and the fabrics may become damaged.

- The clothes may have become entangled during the washing process. Separate them from each other before placing them in the dryer.
- Remove all objects in the pockets of the clothes and apply the following:

Tie fabric belts, apron laces etc. to each other or use a laundry bag.

Lock the zips, clasps and fasteners, do up the buttons of covers.

- To get the best drying result, sort the laundry according to the textile type and drying programme.
- Remove clips and similar metal parts from the clothes.
- Woven goods such as t-shirts and knit clothes **generally shrink in the first drying.** Use a protective programme.
- **Do not over-dry synthetics. This will cause creases.**
- When washing the laundry to be dried, adjust the amount of softener according to the data from the manufacturer of the washing machine.

### LOAD CAPACITY

Follow the instructions in the "Programme selection and consumption table". (See Section 4 Programme selection and consumption table). Do not load the product with more laundry than the capacity values specified in the table.



 **IMPORTANT:** It is not recommended to load the dryer with more laundry than the amount shown in the figure. When overloaded, the drying performance of the dryer will decrease and the dryer and laundry might become damaged.

Laundry	Dry load weight (gr)
Bedsheet (double)	725
Pillowcase	240
Bath Towel	700
Hand Towel	225
Shirt	190
Cotton Shirt	200
Jean	650
Fabric - Gabardine Trousers	400
T-shirt	120

# Care and maintenance

# 6



# Care and maintenance

## Looking after your appliance

### CLEANING AND CARE

**⚠ IMPORTANT:** Do not use industrial chemicals to clean your dryer. Do not use a dryer that has been cleaned with industrial chemicals.

#### CLEANING THE LINT FILTER

**⚠ IMPORTANT:** DO NOT FORGET TO CLEAN THE LINT FILTER AFTER EACH USE.

To clean the lint filter:

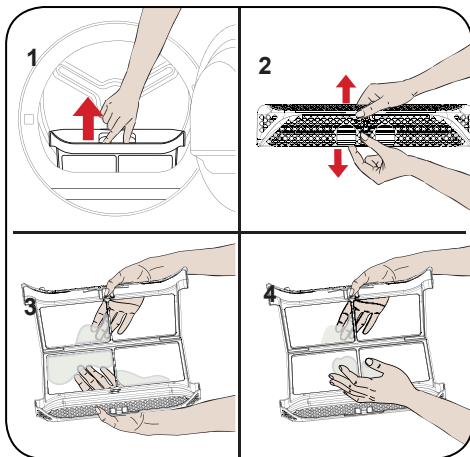

1. Open the loading door.
2. Pull up the lint filter to remove it.
3. Use your hands or a soft cloth to clean the lint.
4. Close and refit the lint filter.

After the dryer has been used for a certain period, you may find a build-up on the filter which may cause an obstruction. Should this arise, remove and clean the filter with warm water and then dry thoroughly before reinstalling.

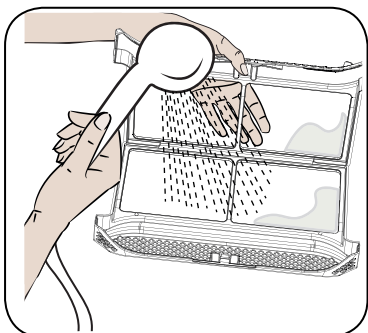

#### EMPTYING THE WATER TANK

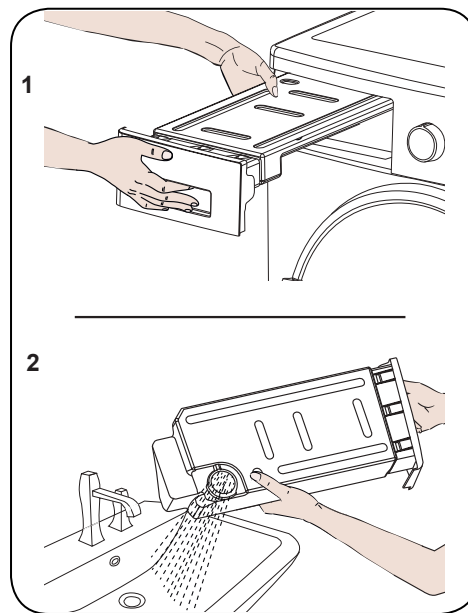

1. Pull the drawer cover and carefully take out the tank.
2. Empty the water in the tank.
3. If there is lint accumulated on the discharge cap in the tank, clean it with water.
4. Refit the water tank.

**⚠ IMPORTANT:** Never remove the water tank when the programme is running. The water condensed in the water tank is not suitable for human consumption.

**⚠ IMPORTANT:** DO NOT FORGET TO EMPTY THE WATER TANK AFTER EACH USE.

#### CLEANING THE CONDENSER

**⚠ IMPORTANT:** Clean the condenser when you see the warning "Condenser Cleaning".

**⚠ IMPORTANT:** EVEN IF THE "CONDENSER CLEANING WARNING LED" IS NOT ON: CLEAN THE CONDENSER AFTER EVERY 30 DRYING PROCESSES OR ONCE A MONTH.

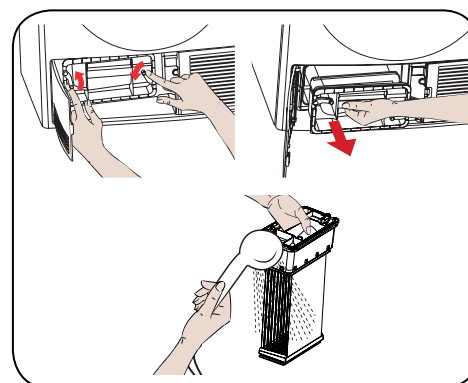

If the drying process is completed, open the loading door and wait for it to cool down.

# Care and maintenance

## Looking after your appliance

1. Open the plinth and release the 2 cover locks of the condenser.
2. Hold the condenser by the plastic part and pull it out.
3. Clean it with a showerhead and wait for the water to drain off.
4. Fully insert the condenser into its seat and lock the 2 locks.
5. Close the plinth cover

### CLEANING THE HUMIDITY SENSOR

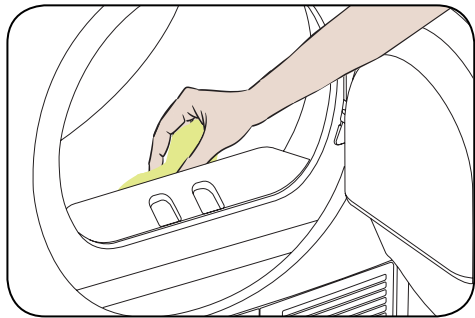

Inside the machine, there are humidity sensors that detect whether the laundry is dry or not.

To clean the sensors:

1. Open the loading door of the machine.
2. If the machine is still hot due to the drying process, wait for it to cool down.
3. Using a soft cloth soaked in vinegar, wipe the metal surfaces of the sensor and dry them.

**👉 IMPORTANT:** CLEAN THE METAL SURFACES OF THE SENSOR 4 TIMES A YEAR.

**👉 IMPORTANT:** Do not use metal tools to clean the metal surfaces of the sensor.

**⚠️ WARNING:** Due to the risk of fire and explosion, do not use solution agents, cleaning agents or similar products when cleaning the sensors.

### CLEANING THE INNER SURFACE OF THE LOADING DOOR

**⚠️ IMPORTANT:** DO NOT FORGET TO CLEAN THE INNER SURFACE OF THE LOADING DOOR AFTER EACH DRYING PROCESS.

Open the loading door of the dryer and clean all of the inner surfaces and the gasket with a soft, damp cloth.

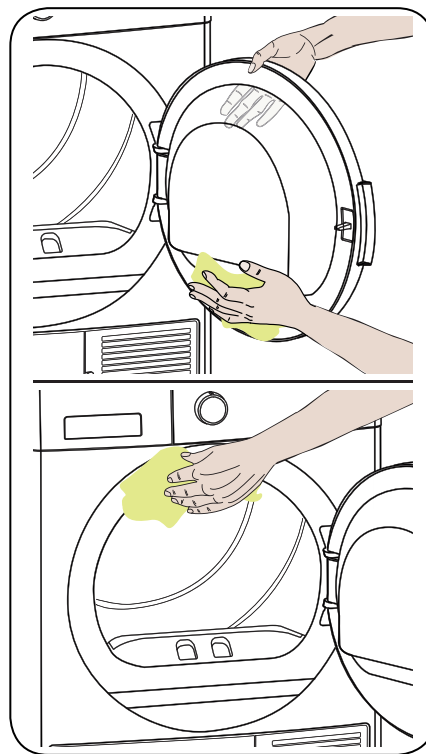

Product support

7



# Product support

## Help is always at hand

### TROUBLESHOOTING

Your dryer is fitted with systems that continuously perform checks during the drying process. This enables it to take the necessary measures and warn you in the case of any malfunction(s).

**⚠ WARNING:** If the problem persists even if you have applied the steps in this section, please contact the your dealer or an Authorised Service Provider. Never try to repair a nonfunctional product.

PROBLEM	REASON	SOLUTION
The drying process takes a long time.	The surface of the lint filter might be clogged.	Wash the filter with lukewarm water.
	The condenser might be clogged.	Clean the condenser.
	The ventilation grills in front of the machine might be closed.	Open the doors/windows to prevent the room temperature from rising too much.
	There might be a layer of limescale on the humidity sensor.	Clean the humidity sensor.
	The dryer might be overloaded with laundry.	Do not overload the dryer.
	The laundry might be insufficiently spun.	Select a higher spin speed on your washing machine.
Laundry comes out damp at the end of the drying process.	⚠ The laundry that comes out hot at the end of the drying process generally feels more humid.	
	The programme used might not be suitable for the type of laundry.	Check the care labels on the laundry items, select a suitable programme for the type of laundry and additionally, use the time programmes.
	The surface of the lint filter might be clogged.	Wash the filter with lukewarm water.
	The condenser might be clogged.	Clean the condenser.
	The dryer might be overloaded with laundry.	Do not overload the dryer.
The dryer cannot be opened or the programme cannot be started. The dryer does not get activated when adjusted.	The dryer might not be plugged in.	Make sure that the plug is fitted in the socket.
	The loading door might be open.	Make sure that the loading door is properly closed.
	You might not have set a programme or pressed the Start/Pause key.	Make sure that the programme has been set and the dryer is not in the Standby (Pause) mode.
	Child lock might be active.	Deactivate the child lock.
The programme has been interrupted for no reason.	The loading door might not be closed properly.	Make sure that the loading door is properly closed.
	There might have been a power failure.	Press the Start/Pause key to start the programme.
	The water tank might be full.	Empty the water tank.
Clothes have shrunk, felted or deteriorated.	The programme used might not be suitable for the type of laundry.	Check the care labels on the laundry items, select a suitable programme for the type of laundry.
Water leaking from the loading door.	There might be lint accumulated on the inner surfaces of the loading door and on the surfaces of the gasket of the loading door.	Clean the inner surfaces of the loading door and the surfaces of the gasket of the loading door.
The loading door opens on its own.	The loading door might not be closed properly.	Push the loading door until you hear the closing sound.
The water tank warning symbol is on/flashing.	The water tank might be full.	Empty the water tank.
	The water discharge hose might be bent.	If the product is connected directly to the water outlet, check the water discharge hose.

If you require any technical guidance or find that your product is not operating as intended, a simple solution can often be found in the Troubleshooting section of these instructions, or online at [www.bush-support.com](http://www.bush-support.com) If you still require further assistance, call one of our experts on 0345 257 7271.

PROBLEM	REASON	SOLUTION
The condenser cleaning warning symbol is on.	The condenser might be unclean.	Clean the condenser.
The filter cleaning warning symbol is on.	The lint filter might be unclean	Clean the filter.
	There might be a layer that causes obstruction on the surface of the lint filter.	Wash the filter with lukewarm water.
	The filter seat might be clogged with lint.	Wash the condenser.
The programme cannot be started and the filter LED is blinking	The filter seat might be clogged with lint.	Clean the filter.
	There might be a layer that causes obstruction on the surface of the lint filter.	Wash the filter with lukewarm water.
	The condenser might not be placed	Ensure the condenser is fitted correctly.
The programme cannot be started and both the condenser and filter LED's are blinking	The condenser and filter might not be placed correctly	Ensure both the condenser and filter are fitted correctly
	The condenser and filter LED's continue blinking even though the filter and condenser are fitted correctly	Call Technical Service

## AUTOMATIC FAULT WARNINGS AND WHAT TO DO

Your tumble dryer is equipped with a built-in fault detection system, indicated by a combination of flashing operation lights. The most common failure codes are shown below.

ERROR CODE	SOLUTION
E03 / 	Empty the water tank, if problem is not solved, contact the nearest authorised service agent.
E04	Contact the nearest authorised service agent.
E05	Contact the nearest authorised service agent.
E06	Contact the nearest authorised service agent.
E08	There may be voltage fluctuation in mains. Wait until voltage is appropriate for working range.

If you require any technical guidance or find that your product is not operating as intended, a simple solution can often be found in the Troubleshooting section of these instructions, or online at [www.bush-support.com](http://www.bush-support.com) If you still require further assistance, call one of our experts on 0345 257 7271.





## TECHNICAL SPECIFICATIONS

<b>Brand</b>	BUSH
<b>Model name</b>	TDT17CN
<b>Height</b>	Min: 845 mm / Max: 855 mm*
<b>Width</b>	596 mm
<b>Depth</b>	525mm
<b>Capacity (max.)</b>	7 kg**
<b>Net weight (with plastic door)</b>	30.5 kg
<b>Net weight (with glass door)</b>	32.5 kg
<b>Voltage</b>	220-240 V
<b>Power</b>	2200 W

\*Min. height: Height with the adjustable feet not used. Max. height: Height with the adjustable feet extended to the maximum.

\*\*Dry laundry weight before washing.

 **IMPORTANT:** To improve the quality of the dryer, technical specifications are subject to change without prior notice.

 **IMPORTANT:** The values declared have been obtained in a laboratory environment according to the relevant standards. These values may change depending on the environmental conditions and use of the dryer.

# Product support

## Help is always at hand

### ENVIRONMENTAL PROTECTION AND PACKAGING INFORMATION

#### PACKAGING INFORMATION

The packaging of this product is made of recyclable materials. Do not dispose of the packaging, waste together with household or other waste. Instead, take it to a packaging collection point defined by your local authority.

### DESCRIBING THE ENERGY LABEL AND SAVING ENERGY

#### ENERGY LABELLING

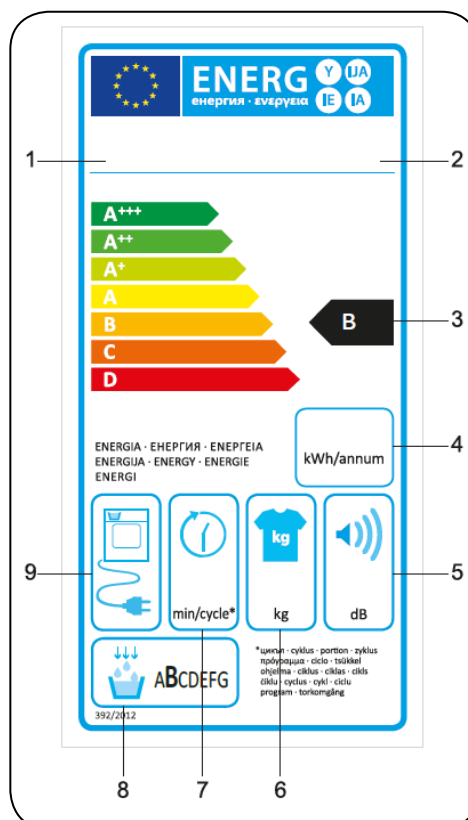

1. Trademark
2. Model
3. Energy Class
4. Annual Power Consumption
5. Noise During Drying
6. Dry Laundry Capacity
7. Cotton Cupboard Dry Cycle Time
8. Condensing Efficiency Class
9. Machine Technology

If you require any technical guidance or find that your product is not operating as intended, a simple solution can often be found in the Troubleshooting section of these instructions, or online at [www.bush-support.com](http://www.bush-support.com) If you still require further assistance, call one of our experts on 0345 257 7271.

## Energy Efficiency

- You should operate the dryer to full capacity, but make sure that it is not overloaded.
- When the laundry is being washed, the spin speed should be at the highest level possible. This will shorten the drying time and reduce energy consumption.
- Make sure that the same kinds of laundry are dried together.
- Please follow the recommendations in the user manual for programme selection.
- For air circulation, leave an appropriate clearance on the front and back sides of the Dryer. Do not cover the grills on the front side of the machine.
- Unless necessary, do not open the door of the machine when drying. If you have to open it, do not keep it open for a long time.
- Do not add new (wet) laundry during the drying process.
- Hairs and lint that detach from the laundry and merge in the air are collected by the "Lint Filters". Please make sure that the filters are cleaned before and after each use.
- For models with a condenser, make sure that the condenser is cleaned at least once a month or after each 30 uses.
- During the drying process, the environment where the dryer is installed must be well ventilated.

PRODUCT FICHE	
Complying Commission Delegated Regulation (EU) No 392/2013	
Supplier name or trademark	BUSH
Model name	TDT17CN
Rated capacity (kg)	7
Type of Tumble Dryer	Condenser
Energy efficiency class <sup>(1)</sup>	B
Annual Energy Consumption (kWh) <sup>(2)</sup>	504
Automatic of Non-automatic	Automatic
Energy Consumption of the standard cotton programme at full load (kWh)	4.18
Energy Consumption of the standard cotton programme at partial load (kWh)	2.31
Power consumption of the off-mode for the standard cotton programme at full load $P_o$ (W)	0.5
Power consumption of the left-on mode for the standard cotton programme at full load $P_l$ (W)	1.0
The duration of the left mode on (min)	n/a
Standard cotton programme <sup>(3)</sup>	
Programme time of the standard cotton programme at full load, $T_{dry}$ (min)	125
Programme time of the standard cotton programme at partial load, $T_{dry1/2}$ (min)	70
Weighted programme time of the standard cotton programme at full and partial load ( $T_l$ )	94
Condensation efficiency class <sup>(4)</sup>	B
Average condensation efficiency of the standard cotton programme at full load $C_{dry}$	81%
Average condensation efficiency of the standard cotton programme at partial load $C_{dry1/2}$	81%
Weighted condensation efficiency of the standard cotton programme at full load and partial load $C_l$	81%
Sound power level for the standard cotton programme at full load <sup>(5)</sup>	65
Built-in	No

(1) Scale from A+++ (most efficient) to D (least efficient)

(2) Energy consumption based on 160 drying cycles of the standard cotton programme at full and partial load and the consumption of the low-power modes. Actual energy consumption per cycle will depend on how the appliance is used.

(3) "Cotton cupboard dry programme" used at full and partial load is the standard drying programme to which the information in the label and the fiche relates, that this programme is suitable for drying normal wet cotton laundry and that it is the most efficient programme in terms of energy consumption for cotton

(4) Scale from G (least efficient) to A (most efficient)

(5) Weighted average value - L wA expressed in dB(A) re 1 pW

## Help and assistance

If you require any technical guidance or find that your washing machine is not operating as intended, a simple solution can often be found in the Troubleshooting section of these instructions or online at [www.bush-support.com](http://www.bush-support.com)

If you still require further assistance, call one of our experts on 0345 257 7271\*. To help give us give you a fast and efficient service please have the following information ready:

Model Ref.	<input type="text"/>	You can find these on the rating plate - a small information panel (usually a sticker or metal plate) on the rear of your appliance
Serial number	<input type="text"/>	
Date of purchase	<input type="text"/>	This will be shown on your receipt

Local call rate applies\*

Lines open 9am-6pm Monday to Saturday and 10am-4pm Sunday.

\*Calls to Bush enquiry lines may attract a charge and set up fee from residential lines depending on your call plan/tariff. Mobile and other providers costs may vary, see [www.bt.com/pricing](http://www.bt.com/pricing) for details.

For Security and training purposes, telephone calls to and from customer service centres maybe recorded and monitored. Calls from Republic of Ireland will attract international call charges.



Notes on disposal :

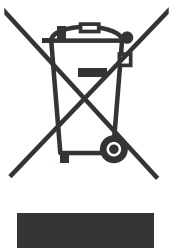

The symbol on the product or its packaging indicates that this product may not be treated as household waste. Instead it should be handed over to the applicable collection point for the recycling of electrical and electronic equipment. By ensuring this product is disposed of correctly, you will help prevent potential negative consequences for the environment and human health, which could otherwise be caused by inappropriate waste handling of this product. For more detailed information about recycling this product, please contact your local council office, your household waste disposal service or the shop where the product was purchased.



Call us now and activate your 12 month guarantee

Thank you for choosing Bush. Your new product is guaranteed against faults and breakdowns for 12 months. Don't forget to register it with us today so we can provide you with our best possible after-sales service and useful updates.

[www.bushregistration.co.uk](http://www.bushregistration.co.uk)

FREEPHONE\*

0800 597 8548

Lines are open 8am - 8pm, 365 days a year. \*Calls may be recorded and monitored.

### Your Bush Guarantee

This product is guaranteed for twelve months from the date of original purchase. Any defect that arises due to faulty materials or workmanship will be repaired free of charge (or if applicable the product will be replaced or the purchase price refunded) where possible during this period by the dealer from who your purchased the unit.

The guarantee is subject to the following provisions:

- The guarantee does not cover accidental damage, misuse, cabinet parts, knobs or consumable items.
- The product must be correctly installed and operated in accordance with the instructions contained in the manual.
- It must be used solely for domestic purposes. The guarantee will be rendered invalid if the product is re-sold or has been damaged by inexpert repair.
- Specifications are subject to change without notice.
- Bush disclaim any liability for loss or damage arising from the breakdown of the product.
- This guarantee is in addition to and does not diminish your statutory or legal rights.

### Important Data Protection Information

To find out how we and Domestic & General Insurance Plc use your data please refer to the guarantee registration material or visit [www.bushregistrations.co.uk](http://www.bushregistrations.co.uk).

Guarantor: Sainsbury's Supermarkets Ltd, 33 Holborn, London EC1N 2HT.

If you require any technical guidance or find that your product is not operating as intended, a simple solution can often be found in the Troubleshooting section of these instructions, or online at [www.bush-support.com](http://www.bush-support.com) If you still require further assistance, call one of our experts on 0345 257 7271.





# BUSH

Produced in Türkiye for Argos  
Limited, London, EC1N 2HT, UK.  
Argos (N.I.) Ltd, Forestside  
Shopping Centre, Upper  
Galwally, Belfast, BT8 6FX, UK.

**Contact:**

[www.bush-support.com](http://www.bush-support.com)

Helpline: 0345 257 7271

52468488