



# STAR WARS™

75348





[LEGO.com/sustainable-packaging](https://www.lego.com/sustainable-packaging)



# BUILDER



Apple and the Apple logo are trademarks of Apple Inc., registered in the U.S. and other countries and regions. App Store is a service mark of Apple Inc. Google Play and the Google Play logo are trademarks of Google LLC. Tencent and the Tencent logo are trademarks of Tencent Inc.

[LEGO.com/devicecheck](https://www.lego.com/devicecheck)

EN Ask parents' permission before going online | DE Eltern um Erlaubnis bitten, bevor du online gehst | FR Demande l'autorisation d'un parent avant d'aller en ligne | IT Chiedi il permesso ai tuoi genitori prima di andare online | ES Pídeles permiso a tus papás antes de conectarte a Internet | PT Pede autorização aos pais antes de acederes online | ZH 上网前应先征得父母的同意 | PL Poproś rodziców o zgodę, zanim wejdiesz do Internetu | CS Než půjdeš na internet, požádej rodiče o svolení | SK Skôr než pôjdeš na internet, vypýtaj si povolenie od rodičov | HU Kérj szülői engedélyt, mielőtt online csatlakoznál! | RO Cere permisiunea părinților înainte de a te conecta online | BG Поискайте разрешение от родител, преди да влезете онлайн | LV Pirms došanās tiešsaistē palūdz atļauju vecākiem | ET Enne Interneti kasutamist küsi vanematelt luba | LT Prieš prisijungdami prie interneto, atsklauskite tėvų

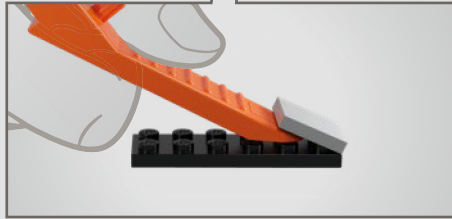
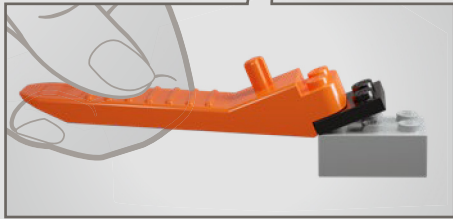
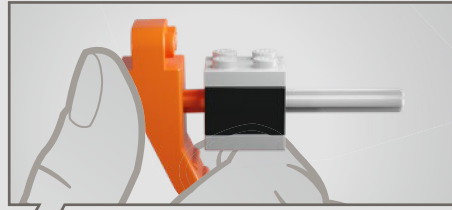
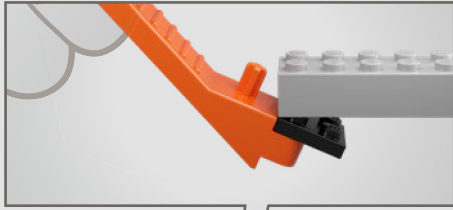



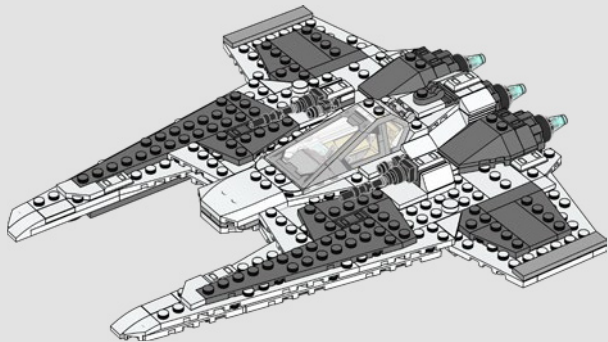
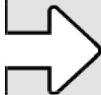
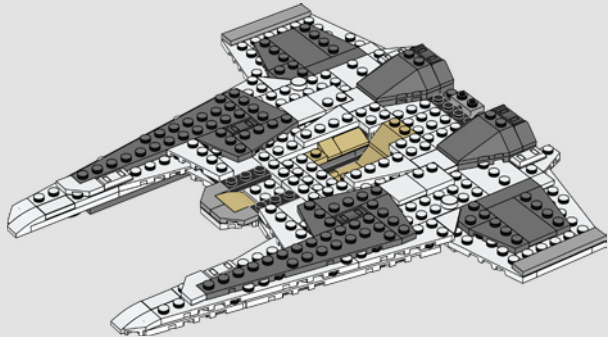
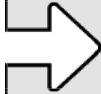
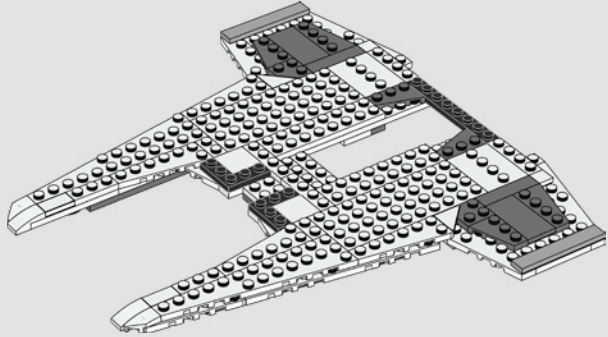
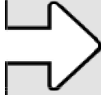

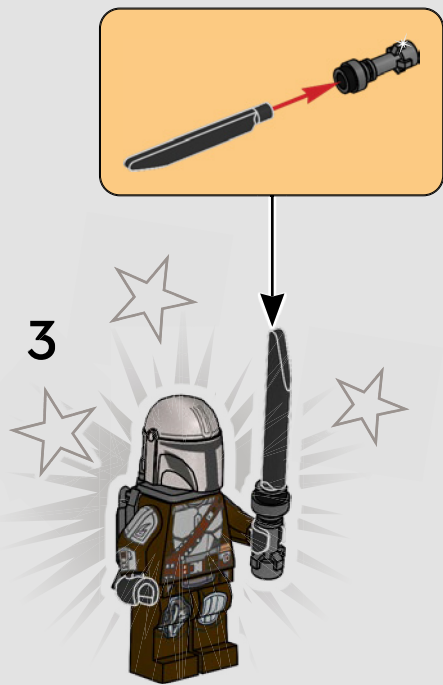
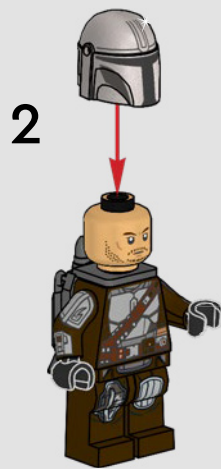
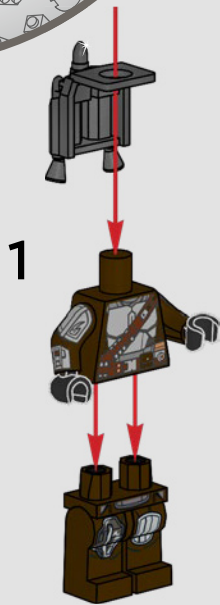

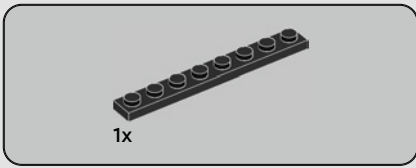

1

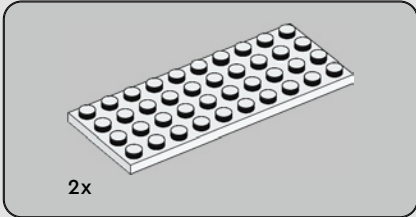
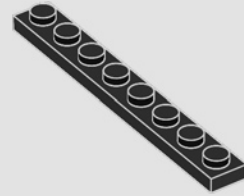

2

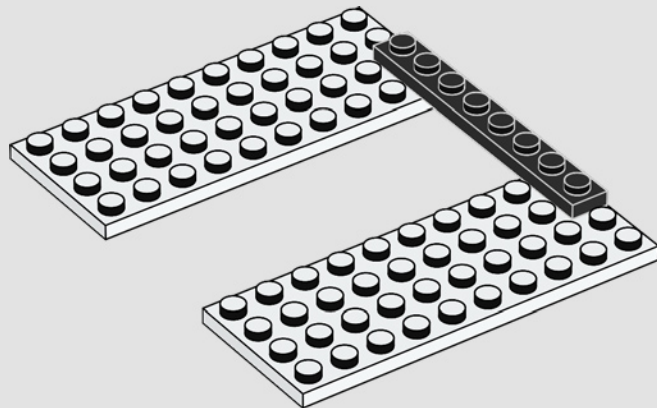

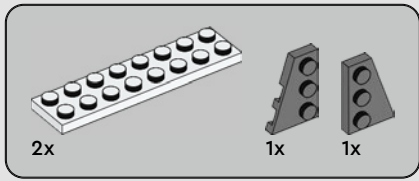

3

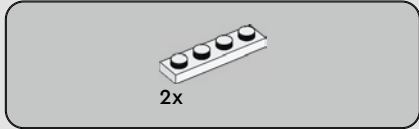
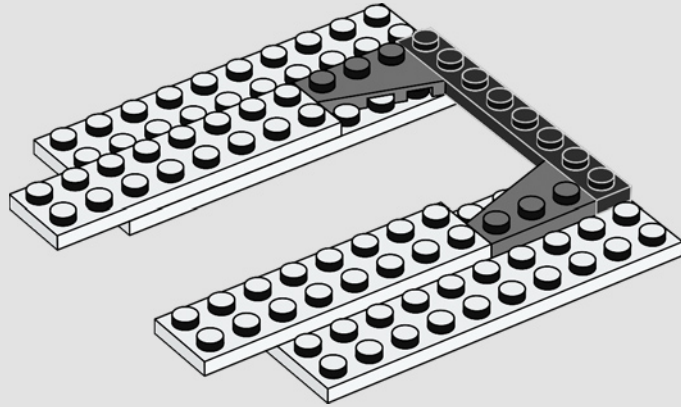

4

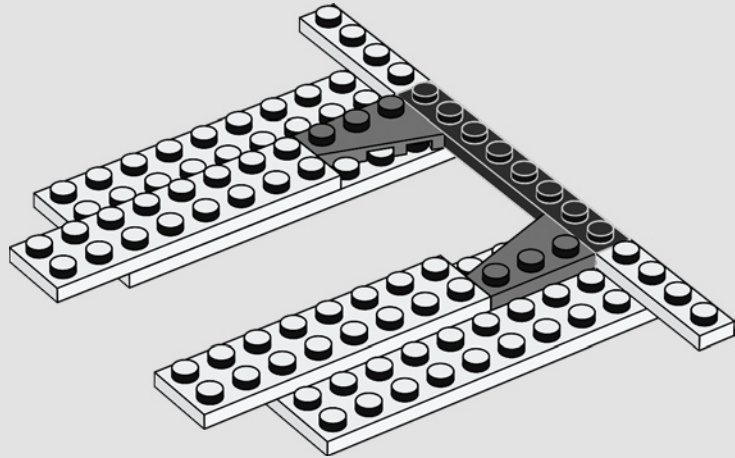



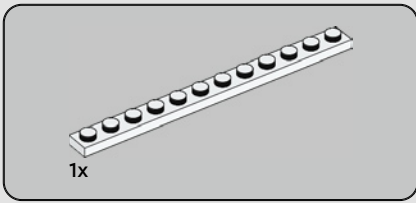

5

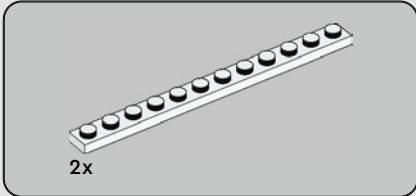
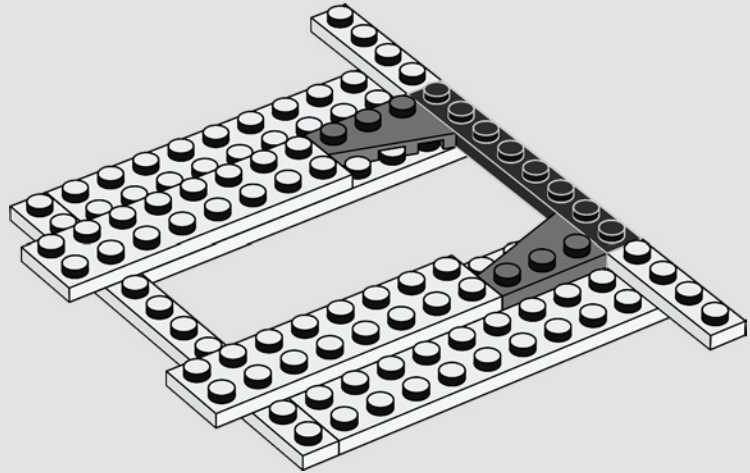

6

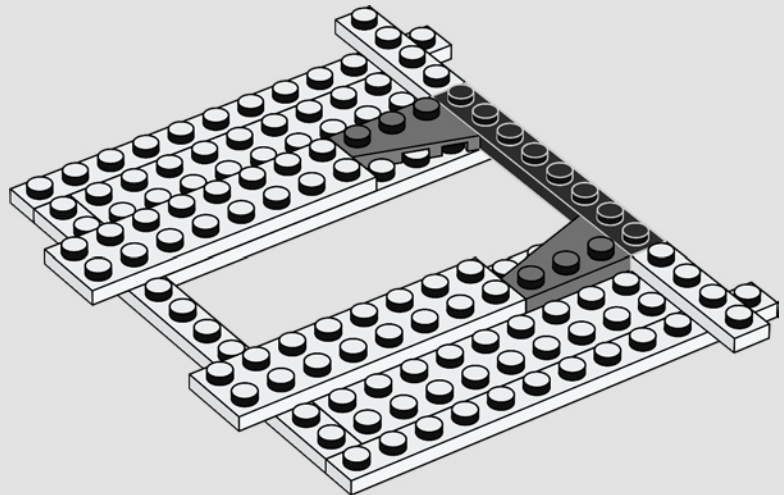

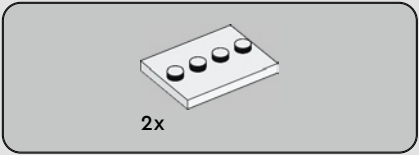

7

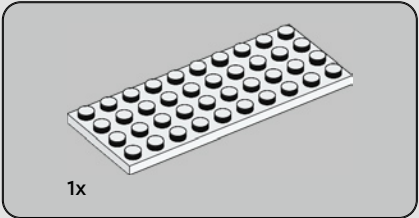
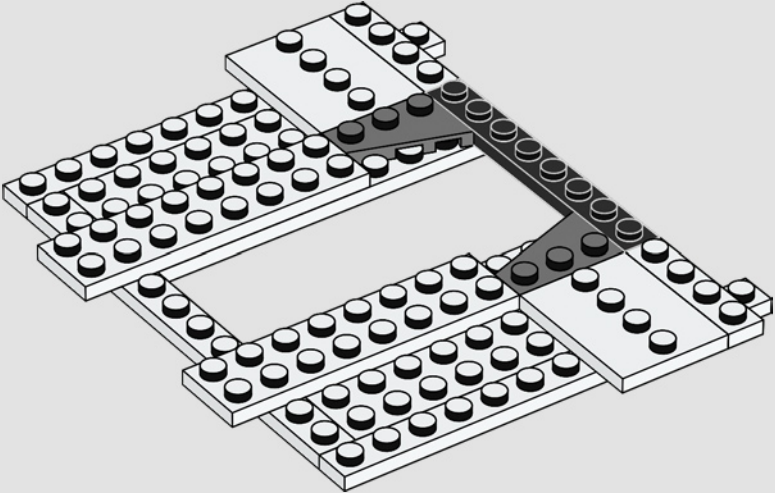

8

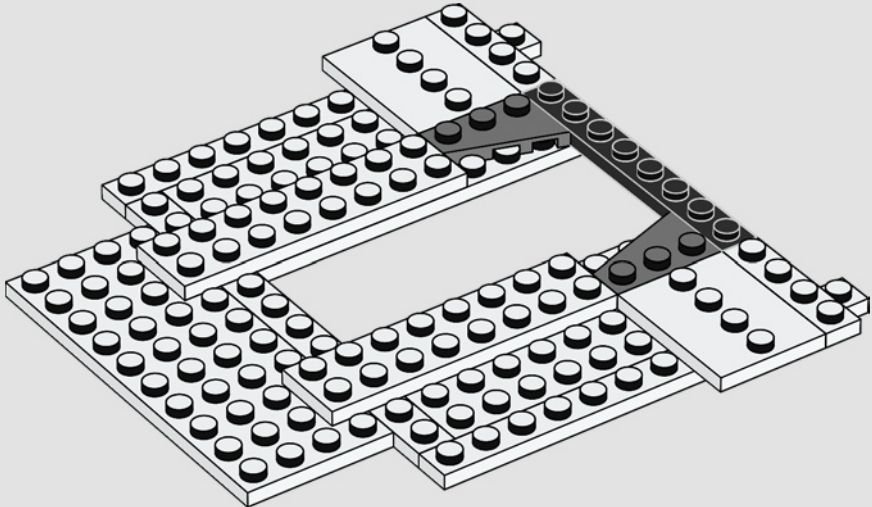

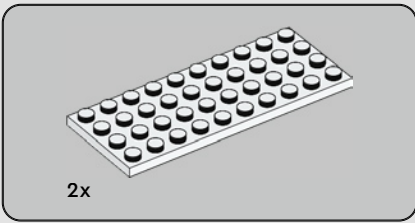

9

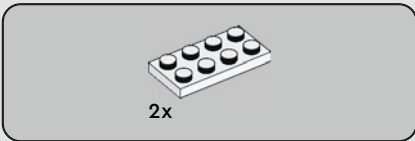
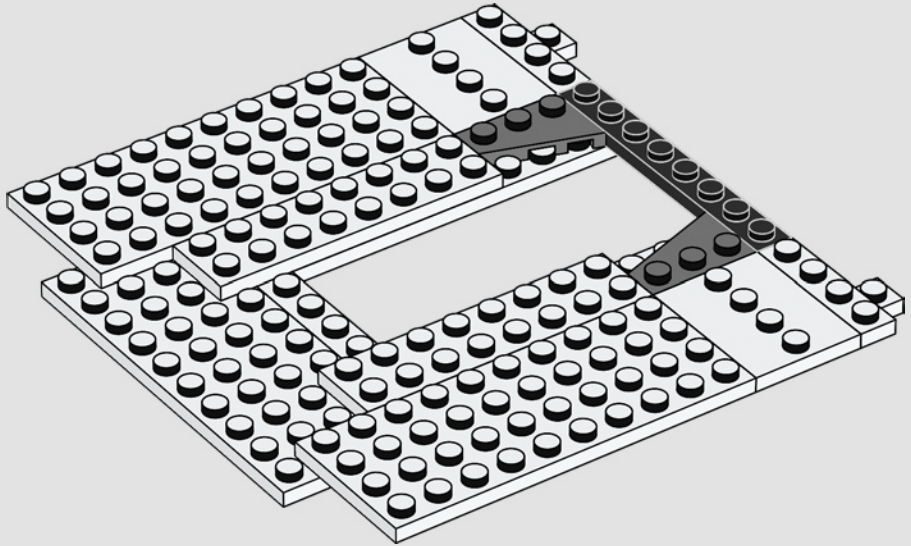

10

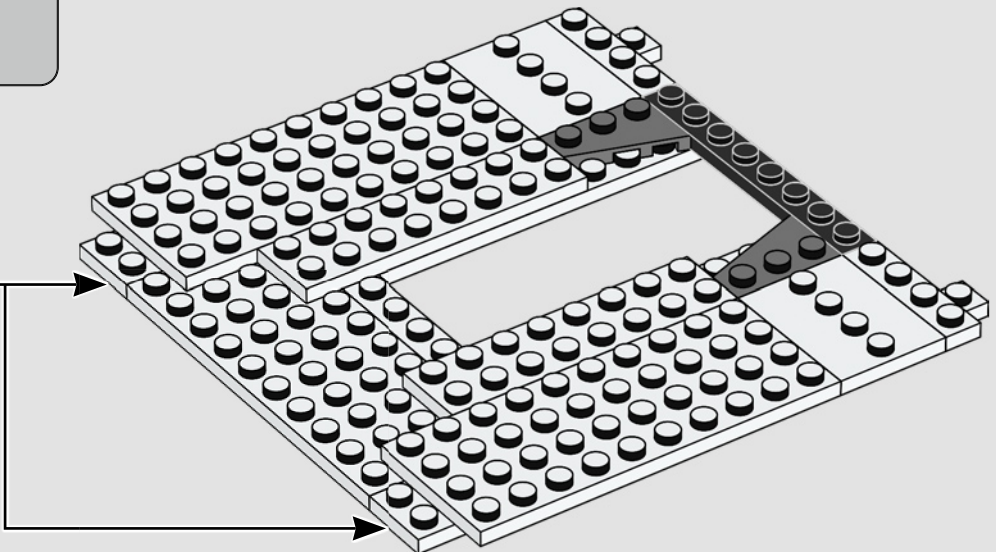
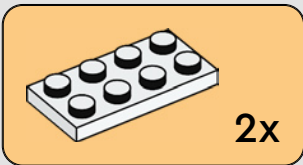



2x

11

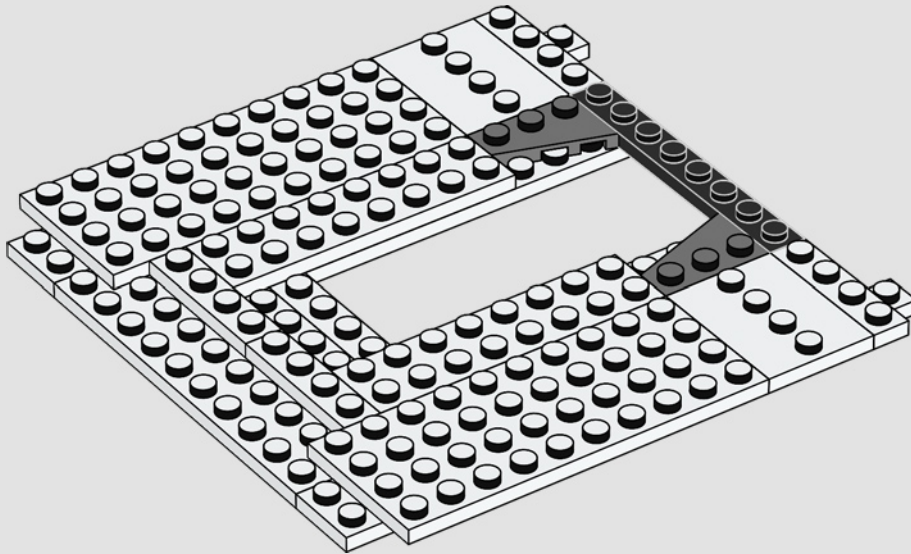



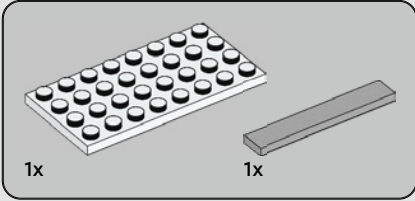
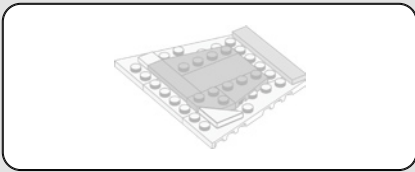

12

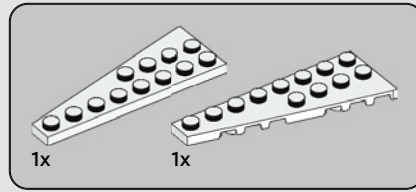
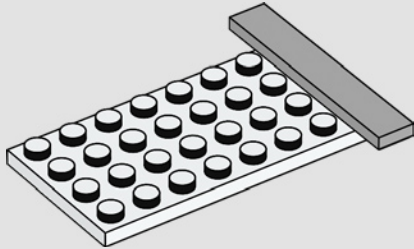

13

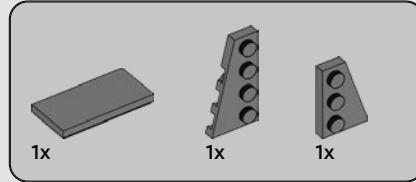
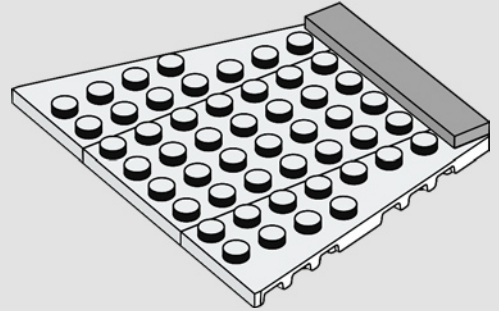

14

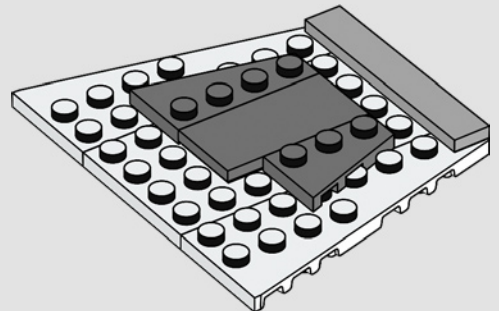

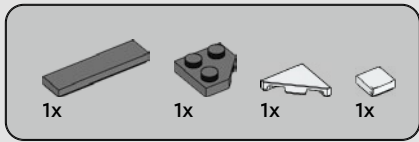

15

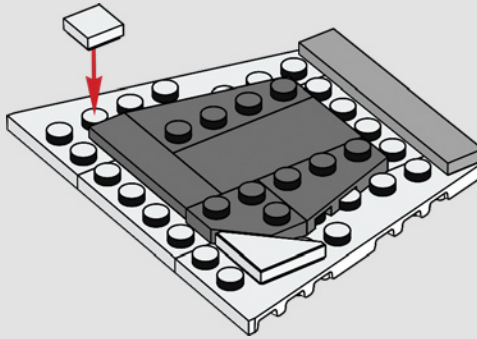

16

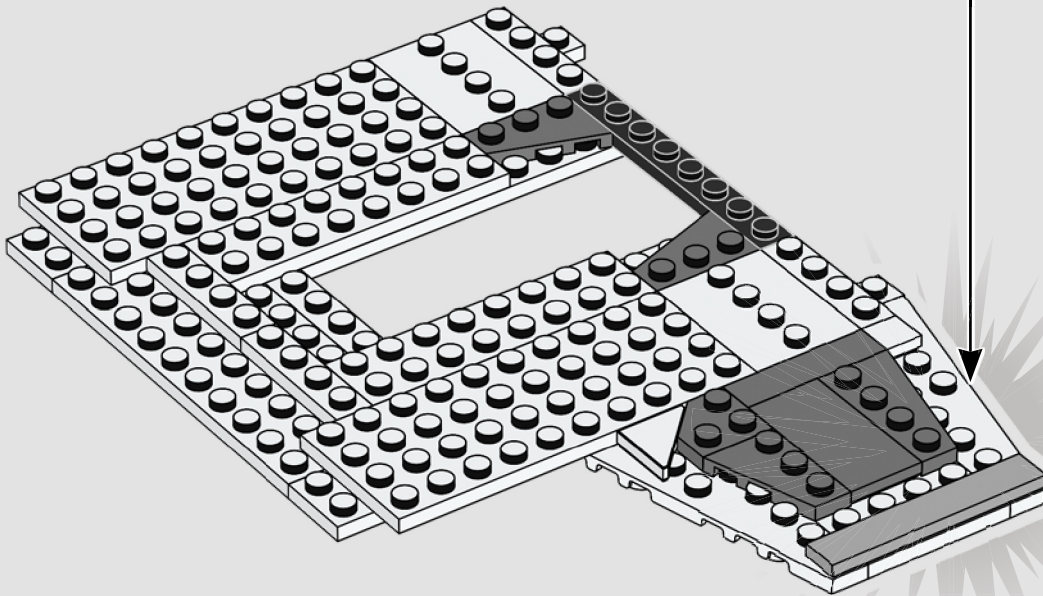

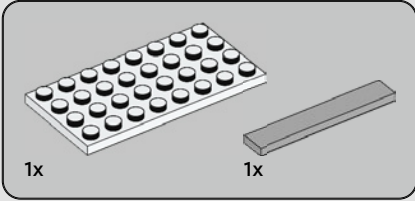
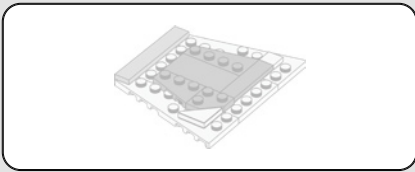

17

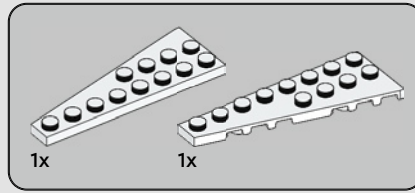
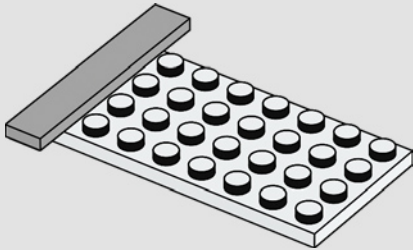

18

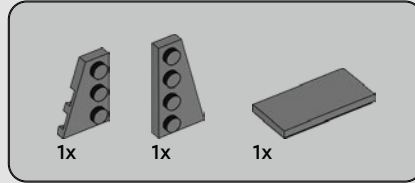
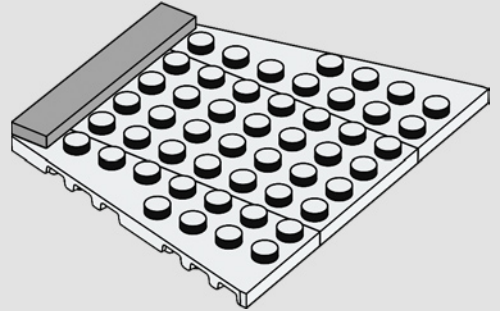

19

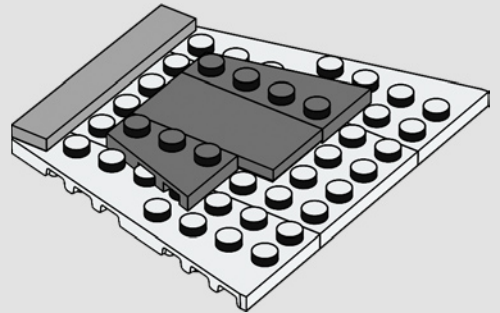

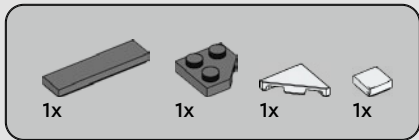

20

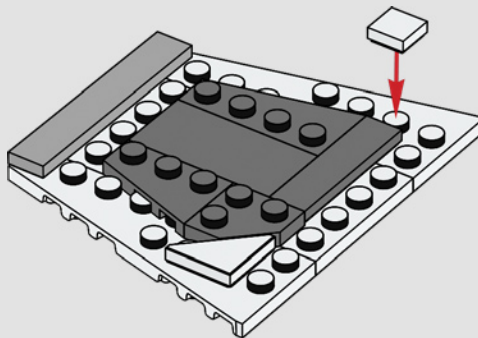

21

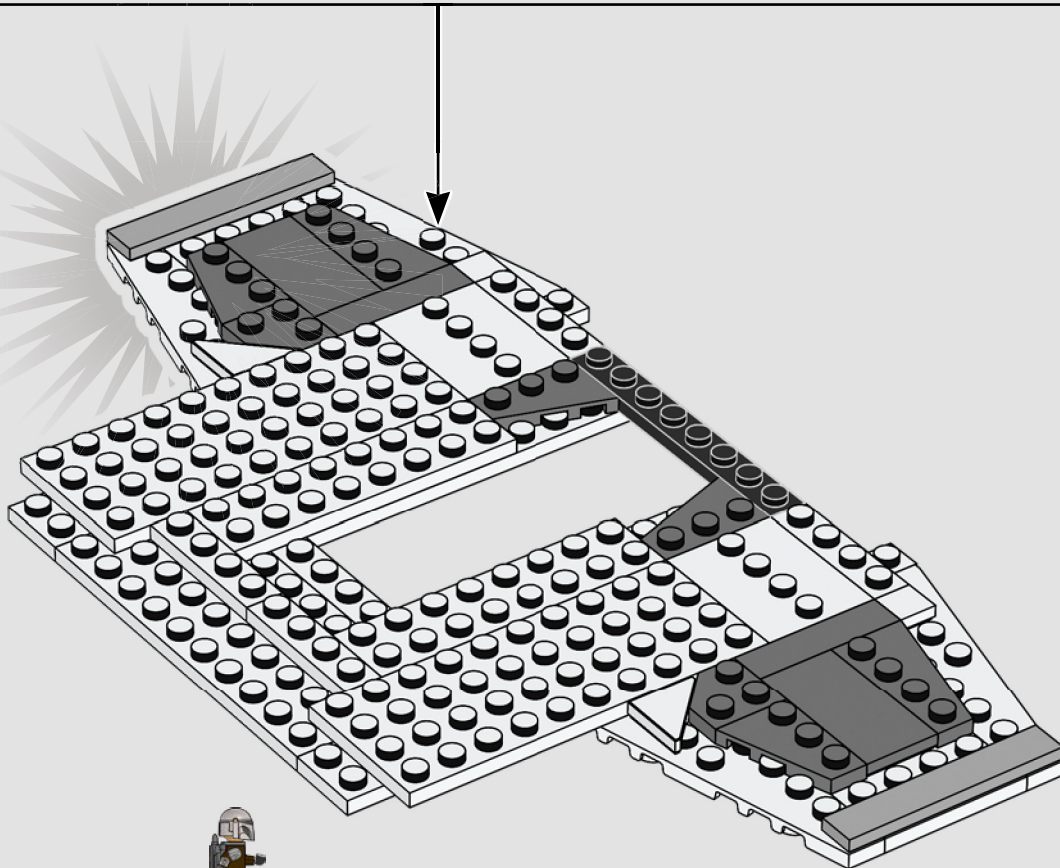



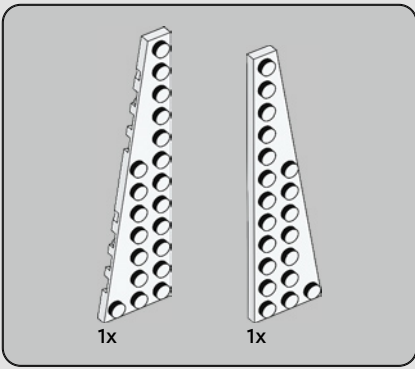

22

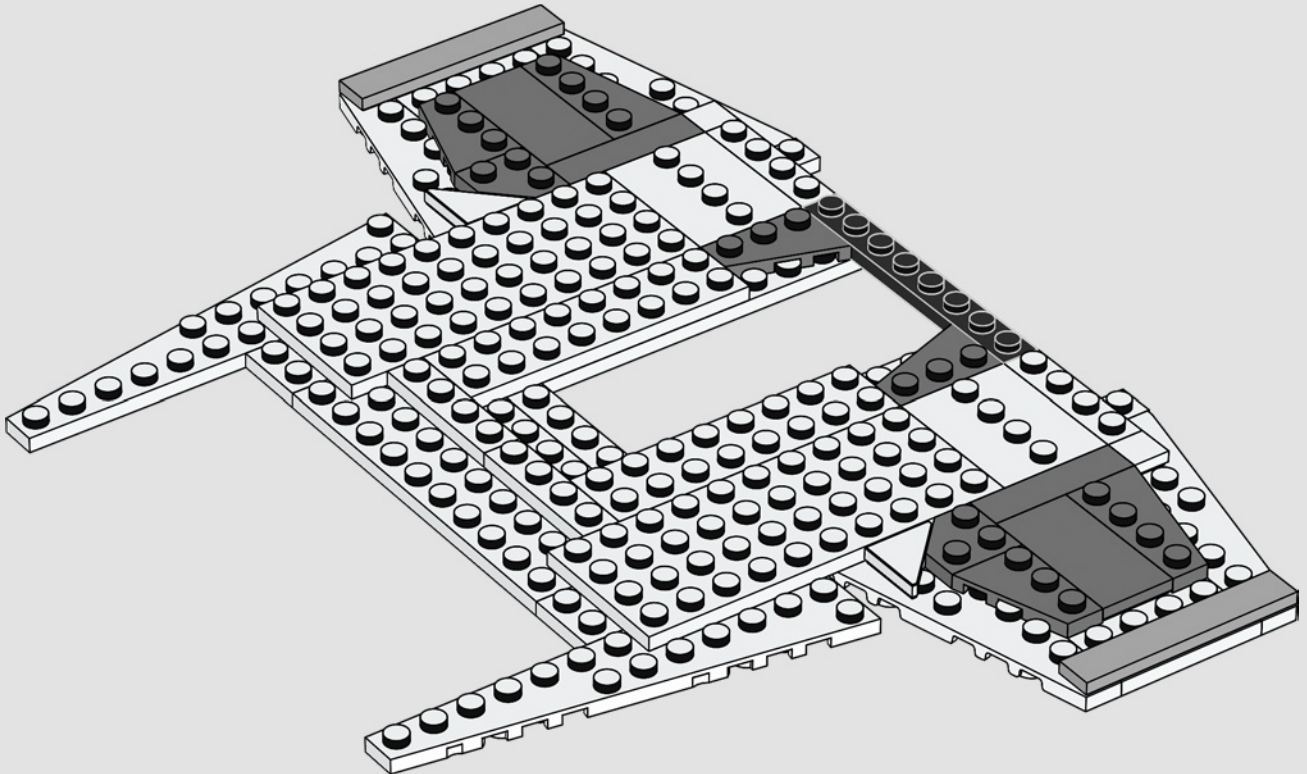

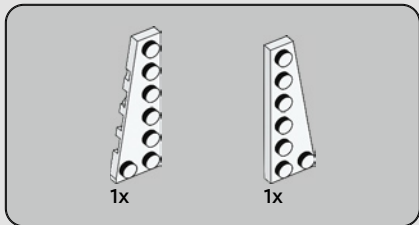

23

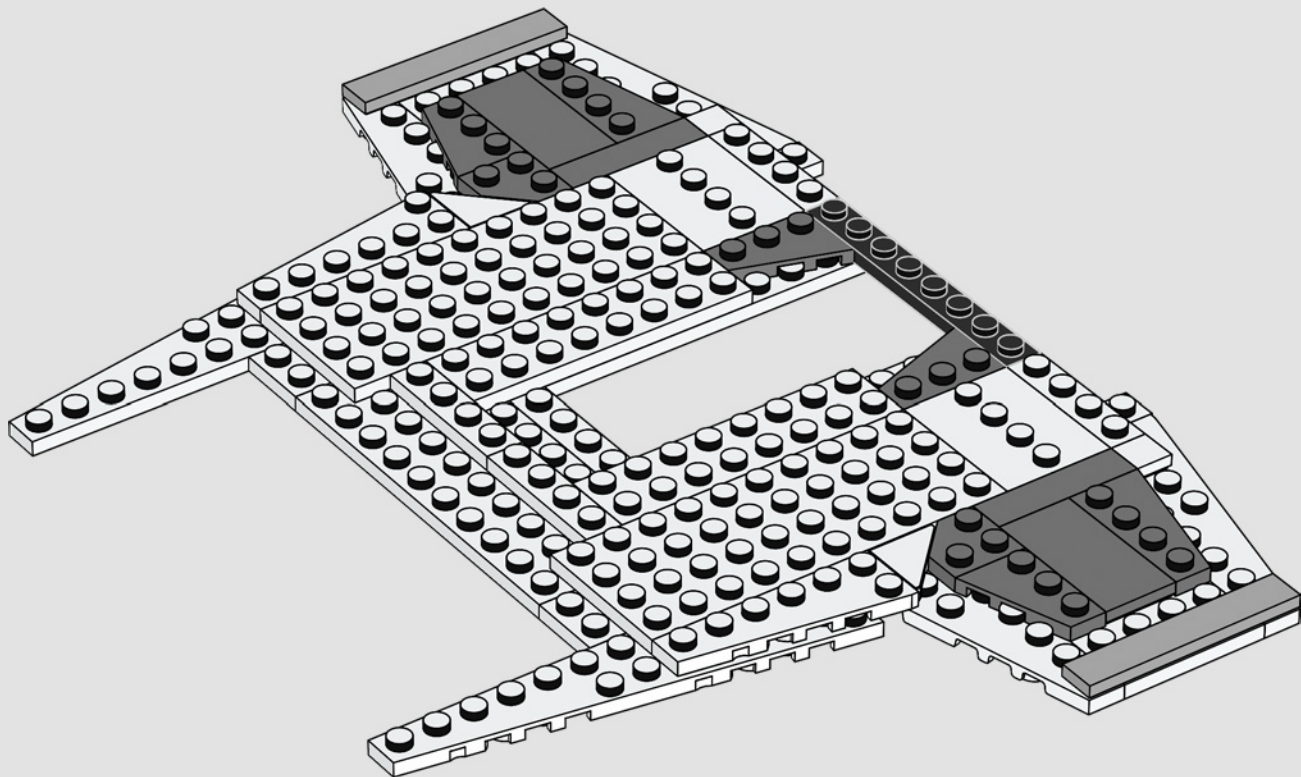

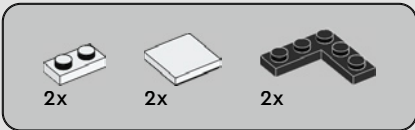

24

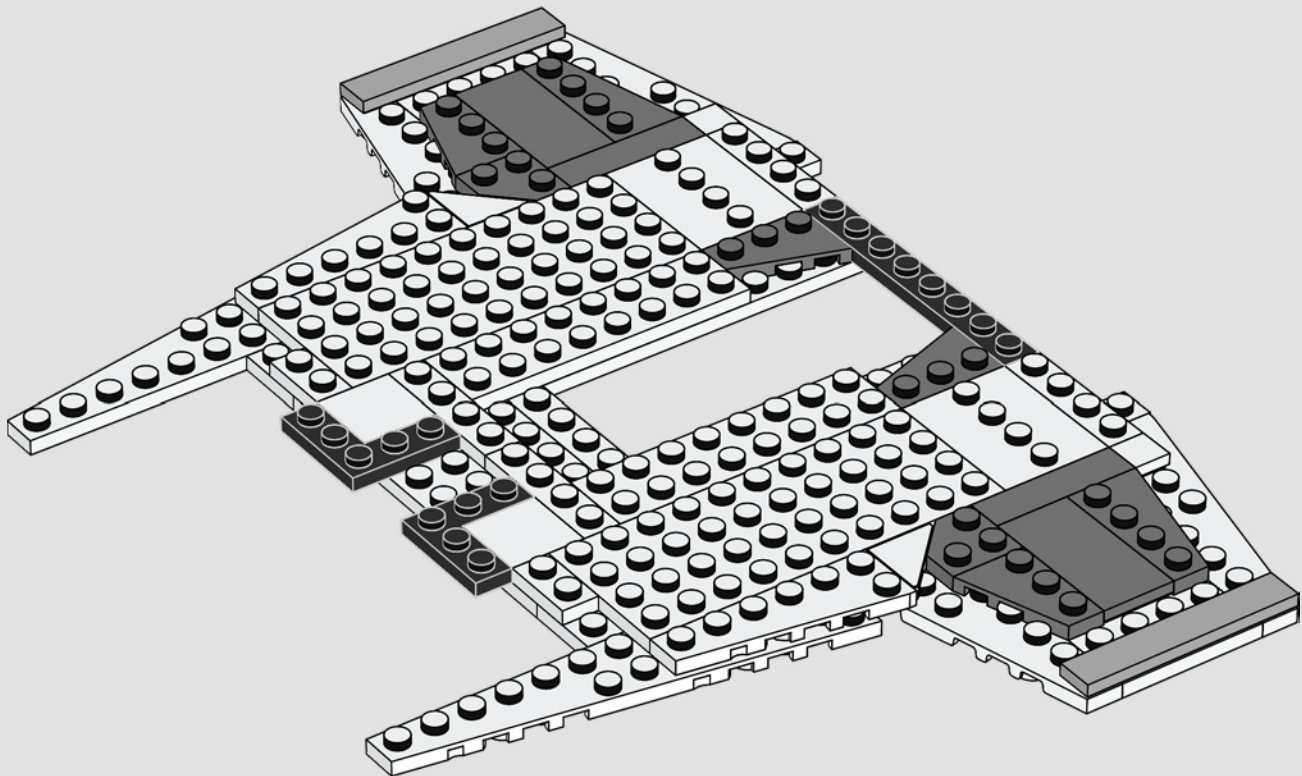

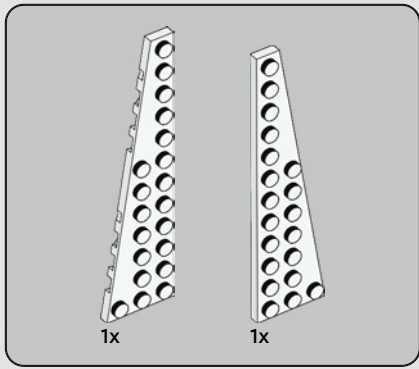

25

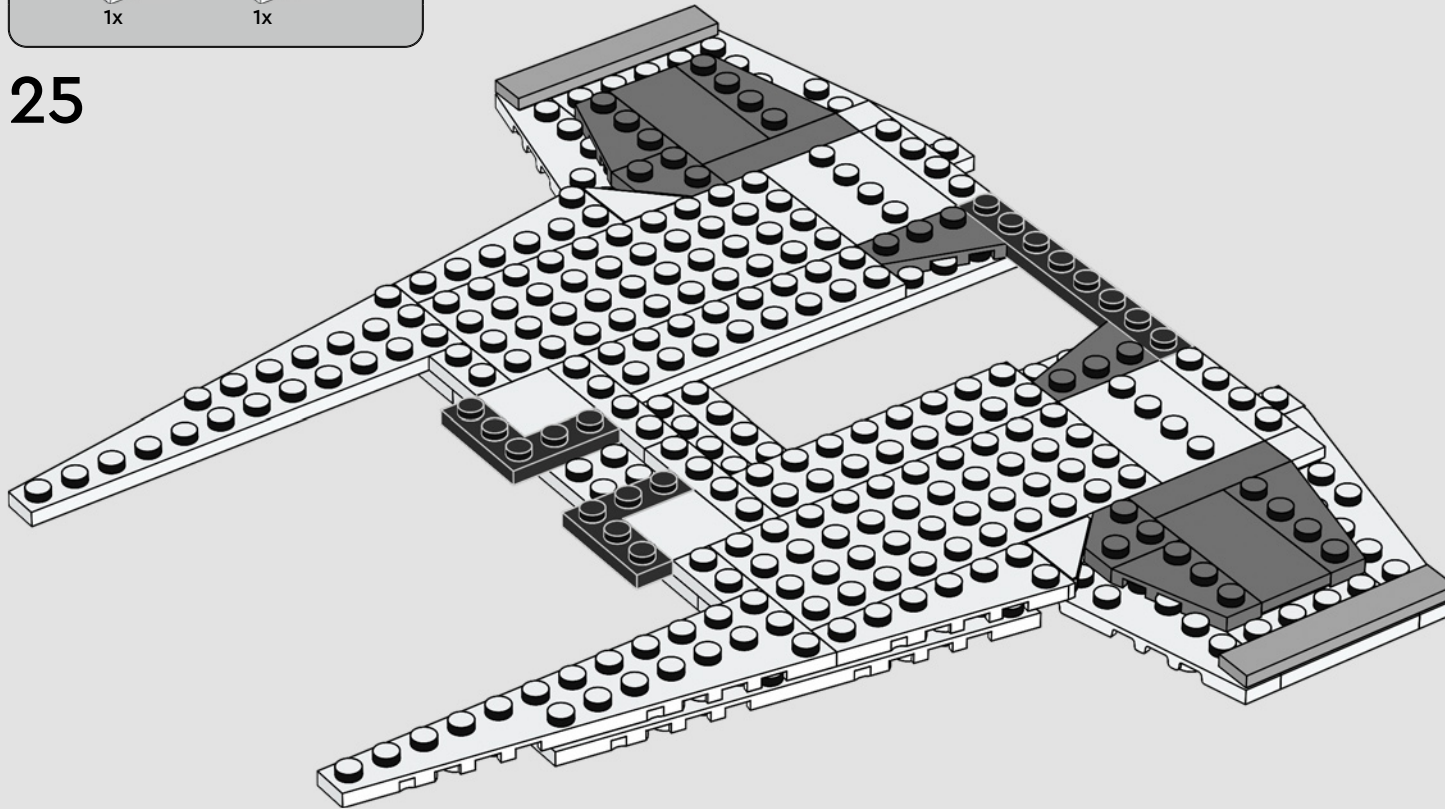



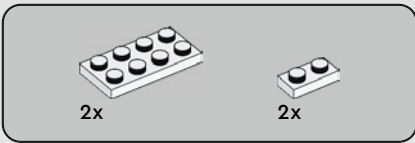

26

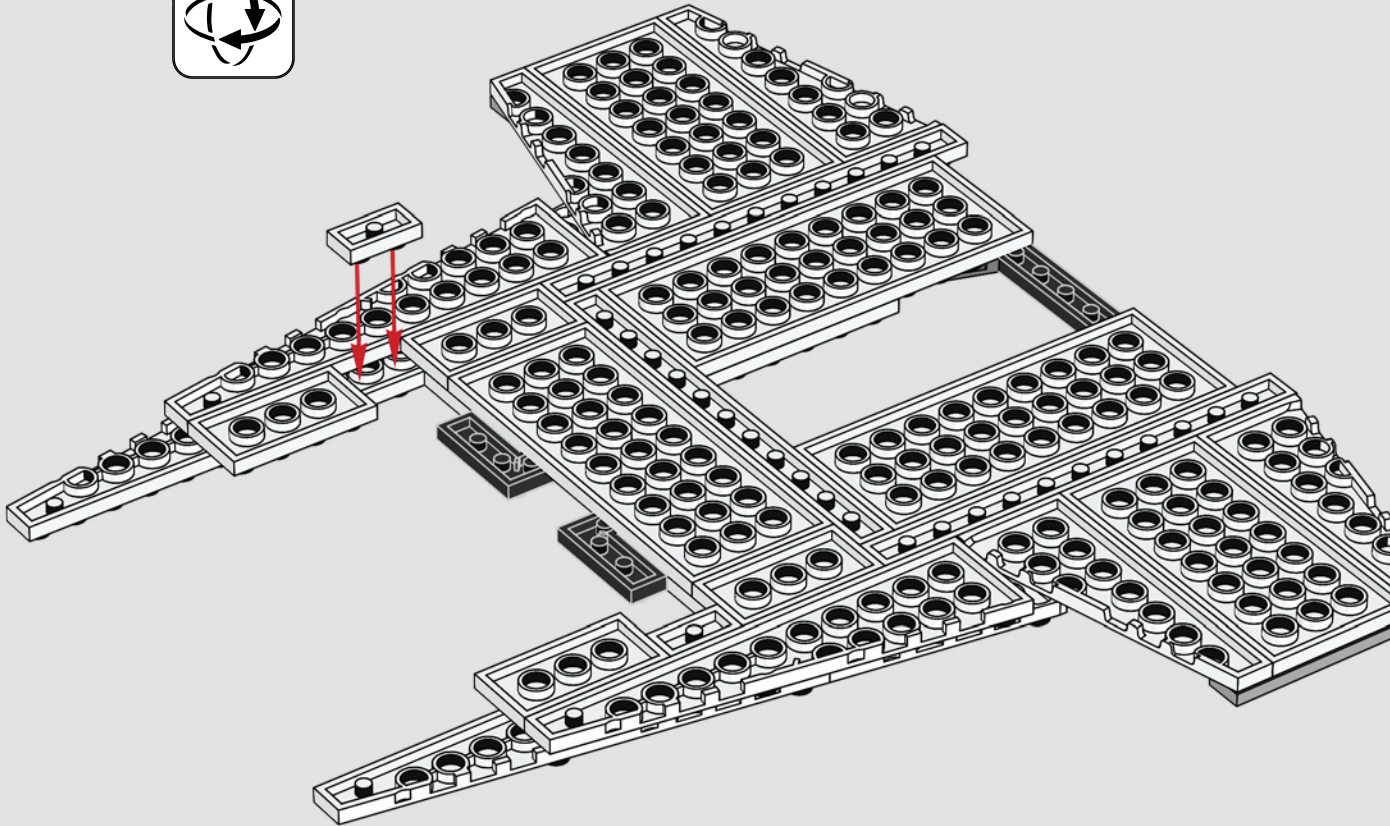

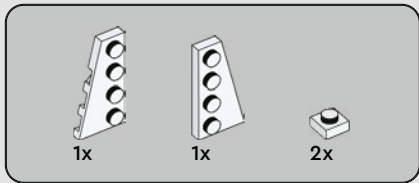

27

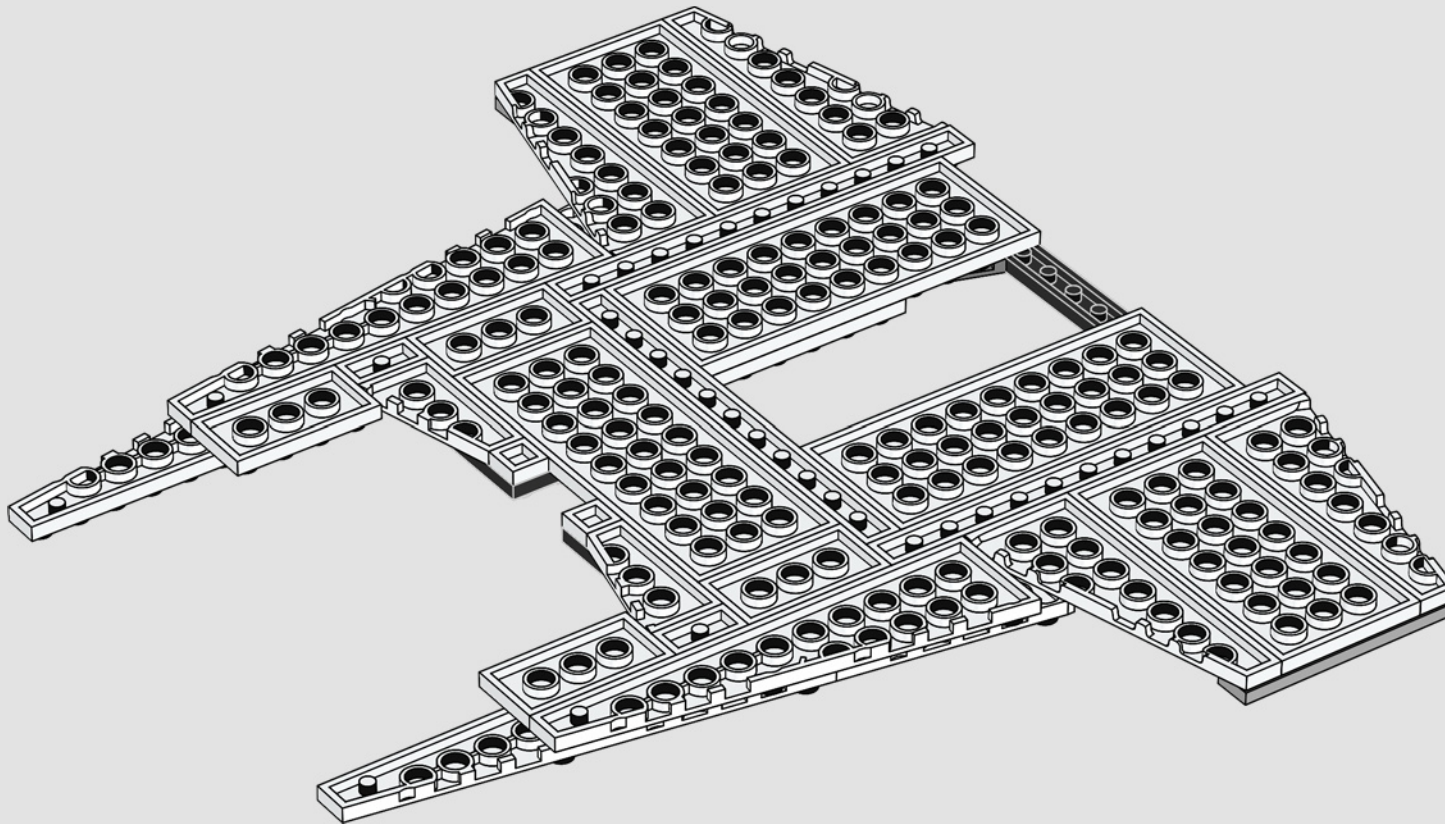

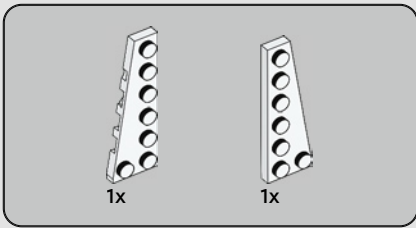

28

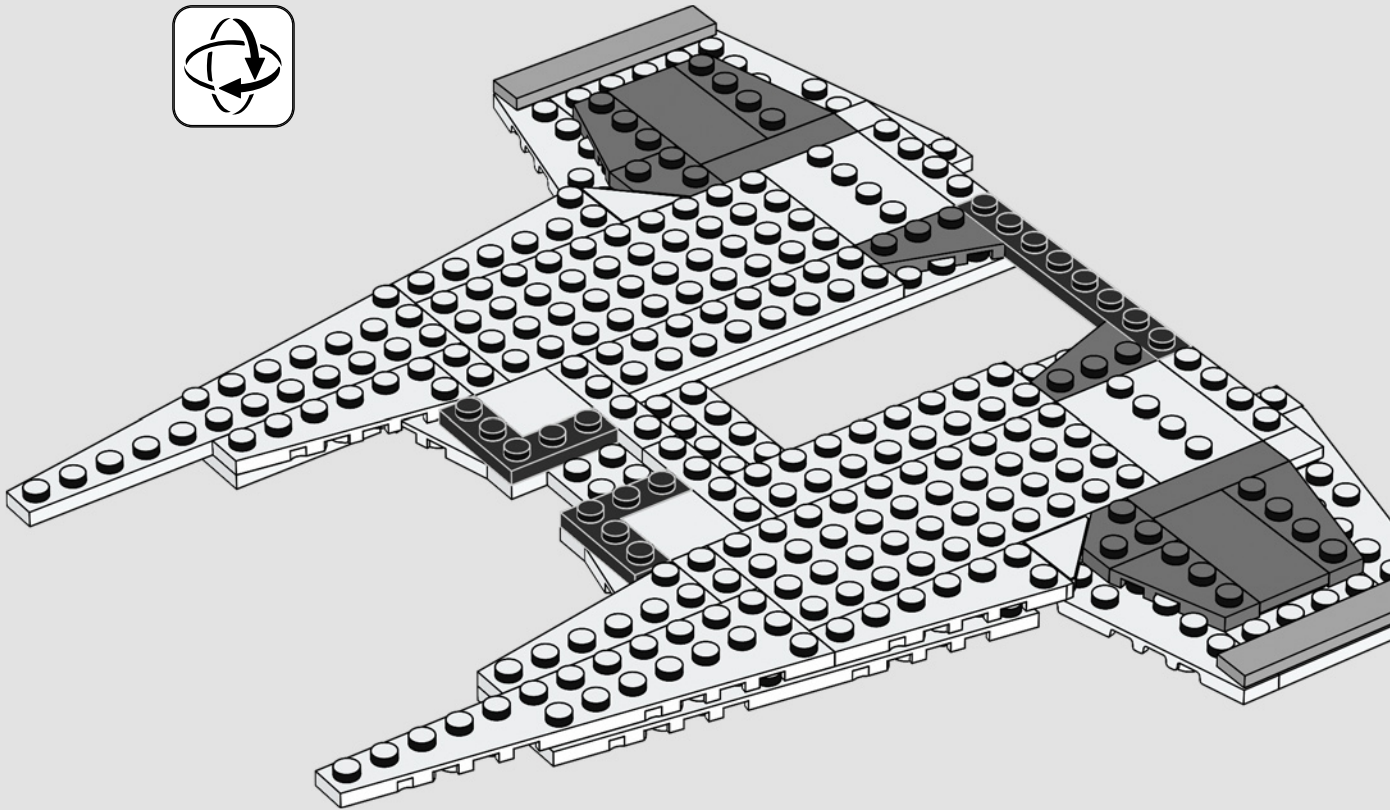

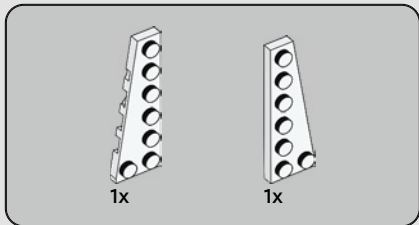

29

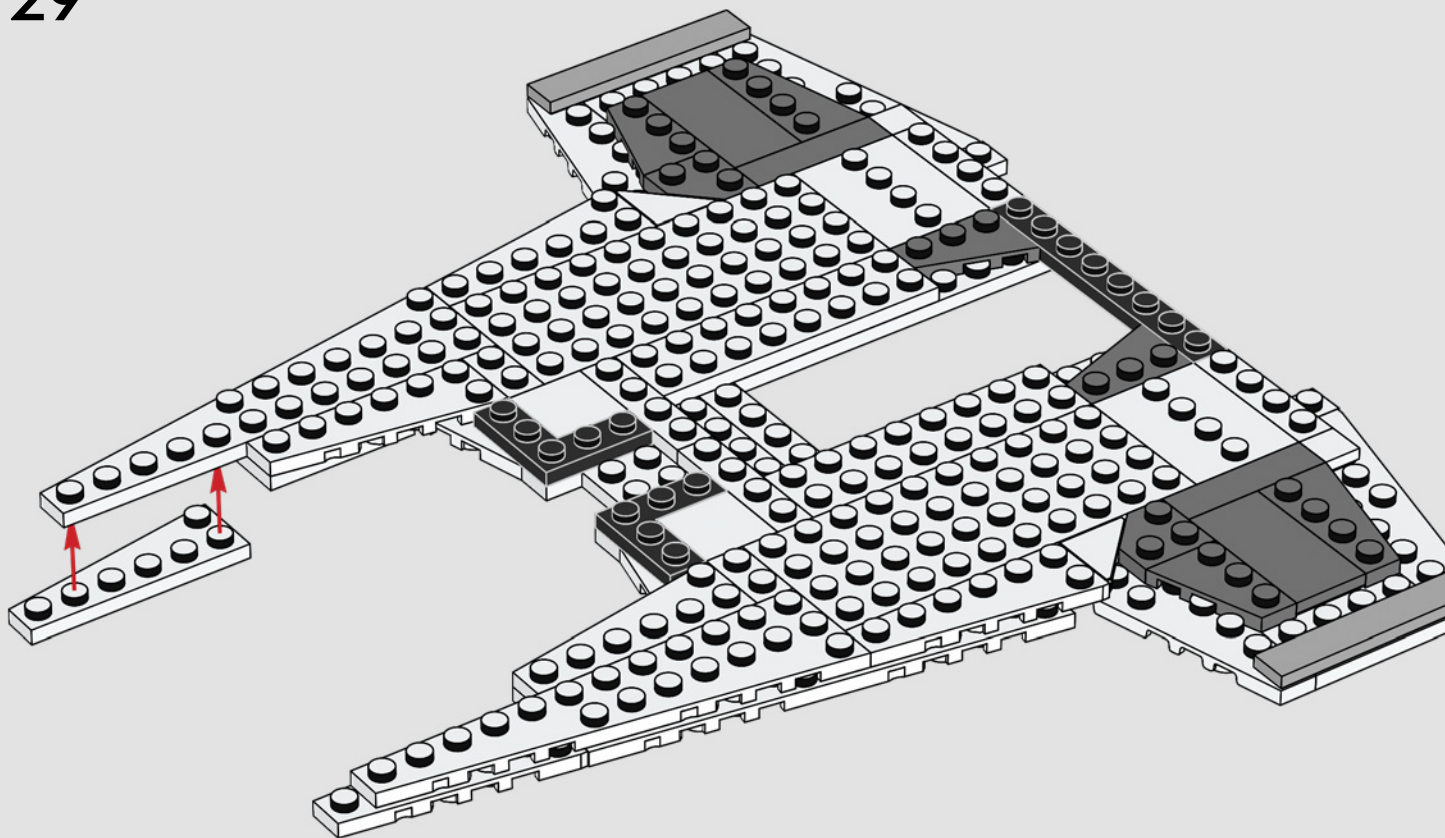



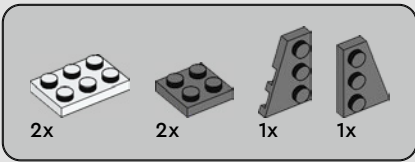

30

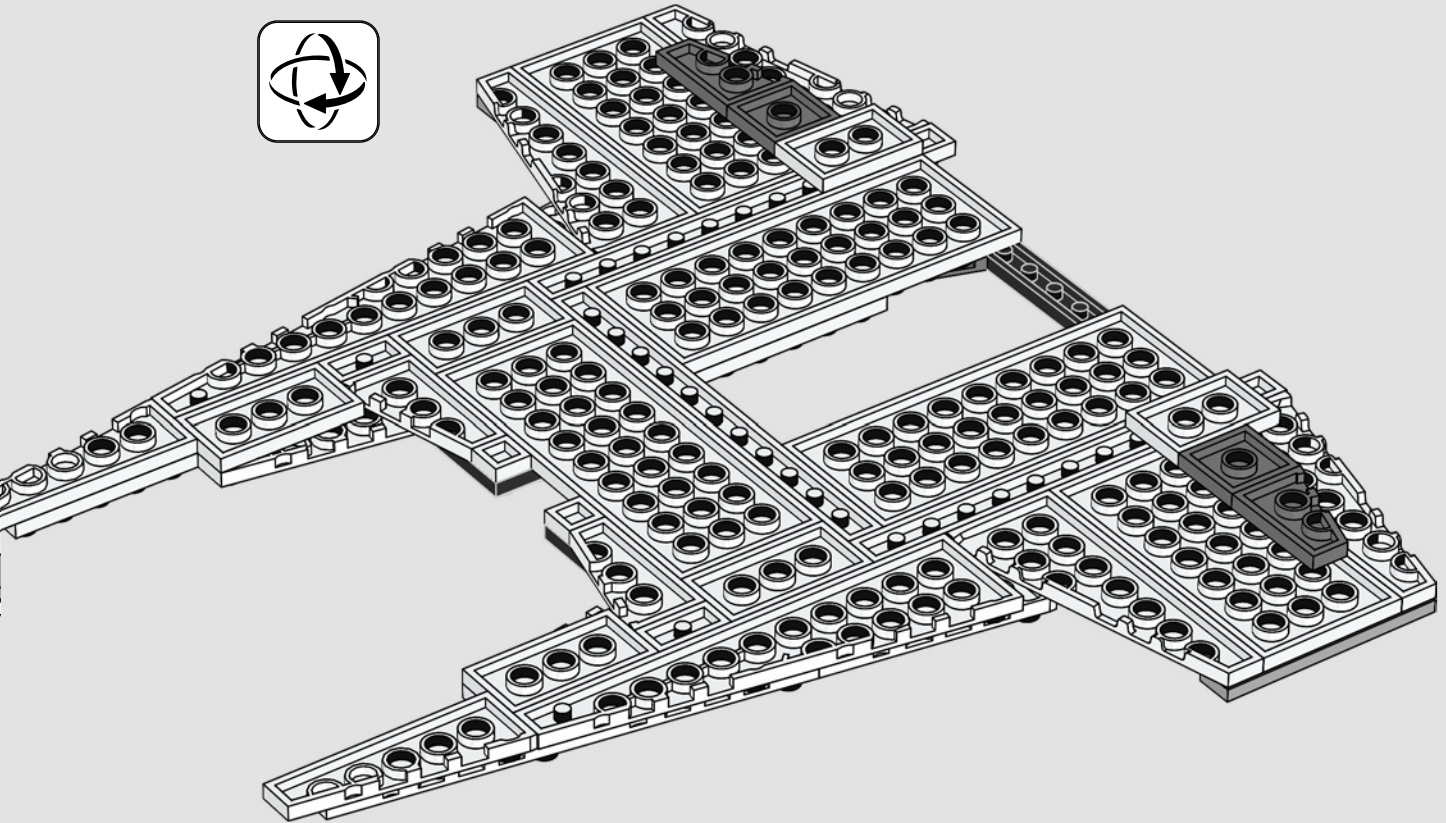

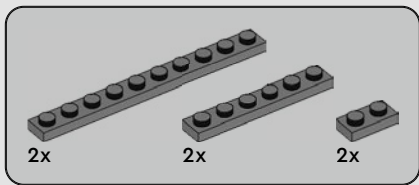

31

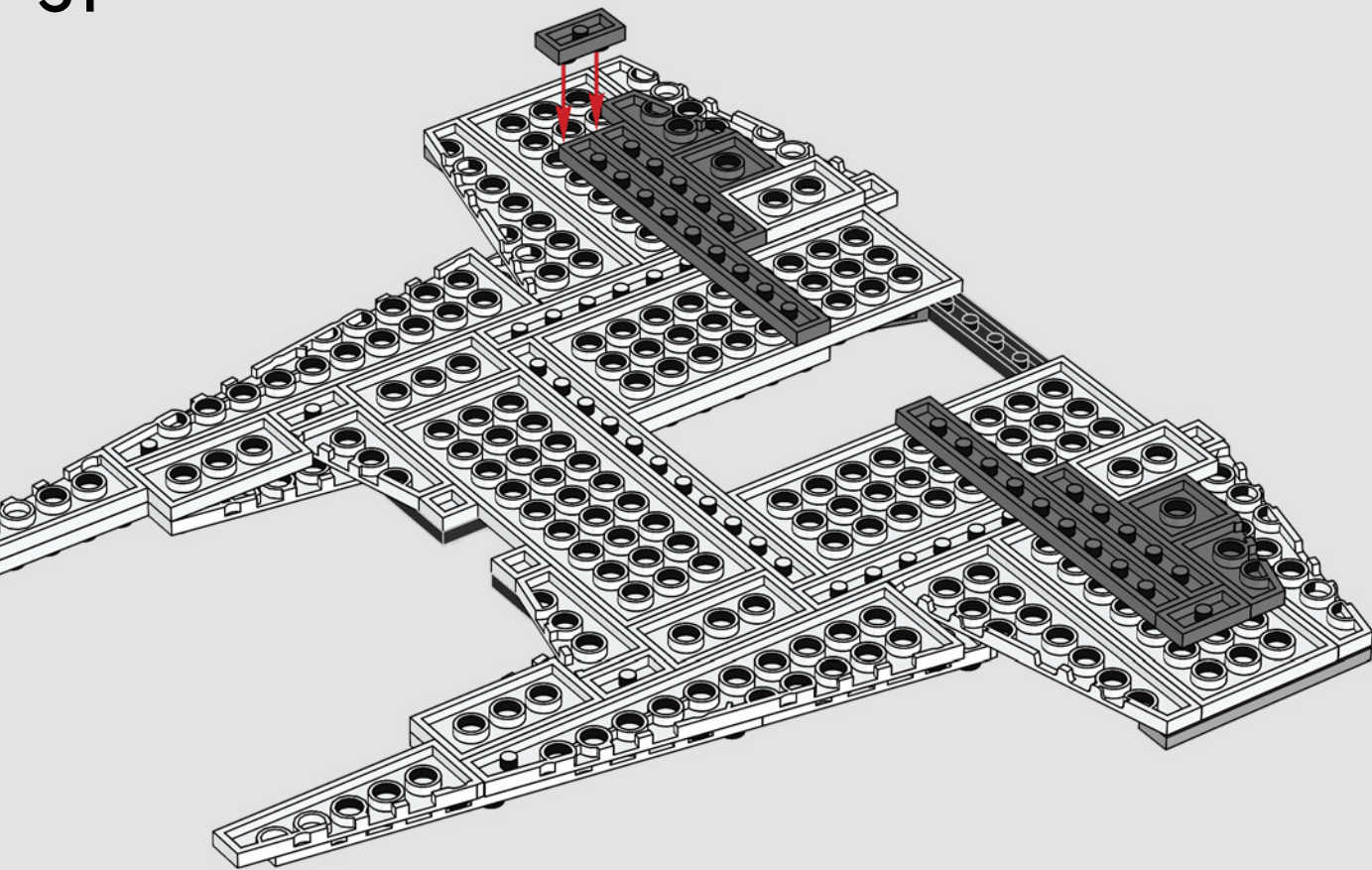

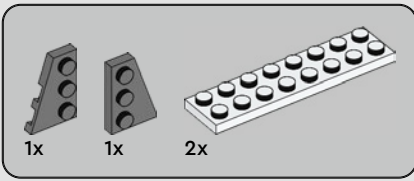

32

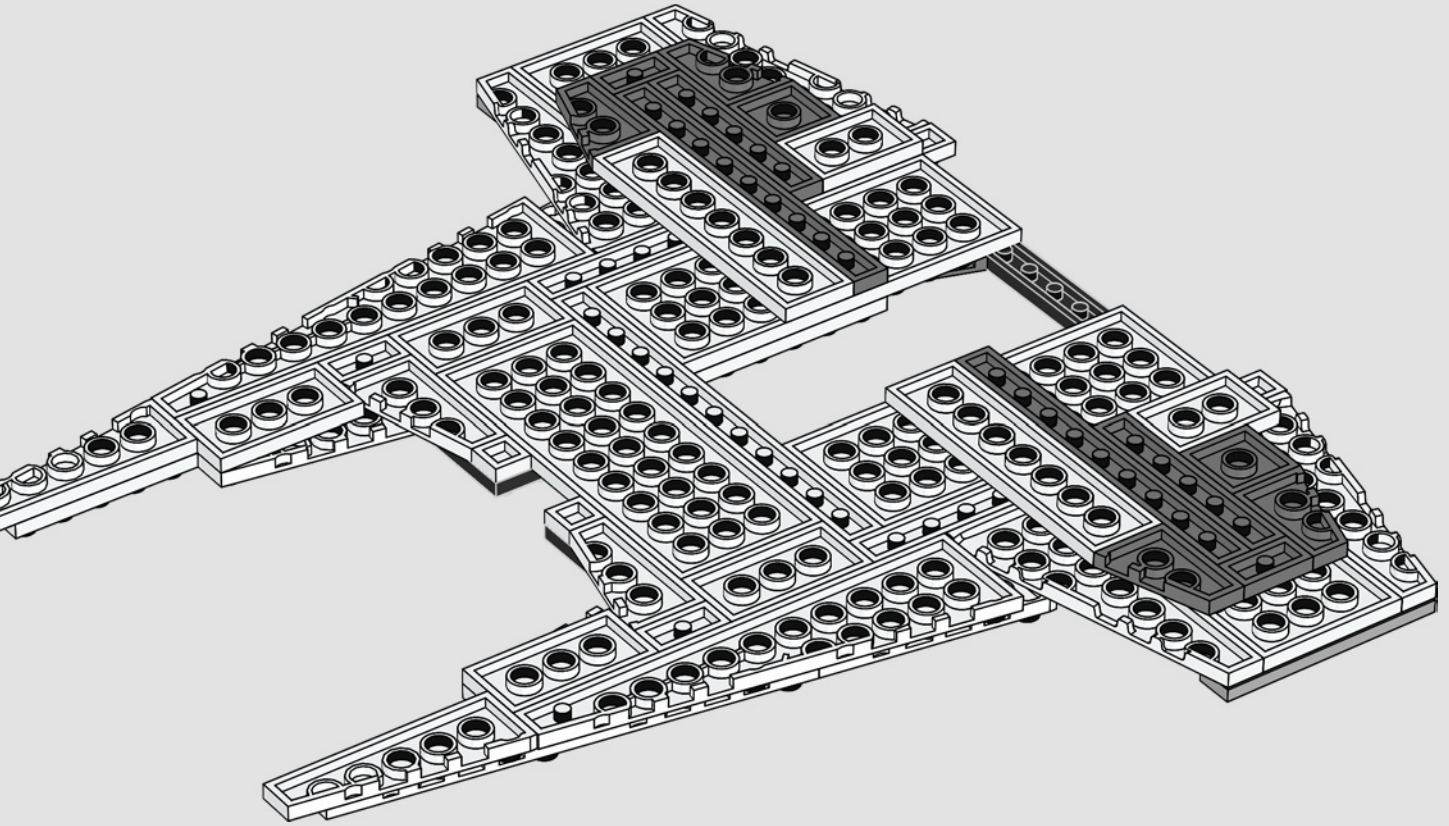



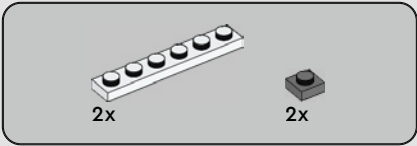

33

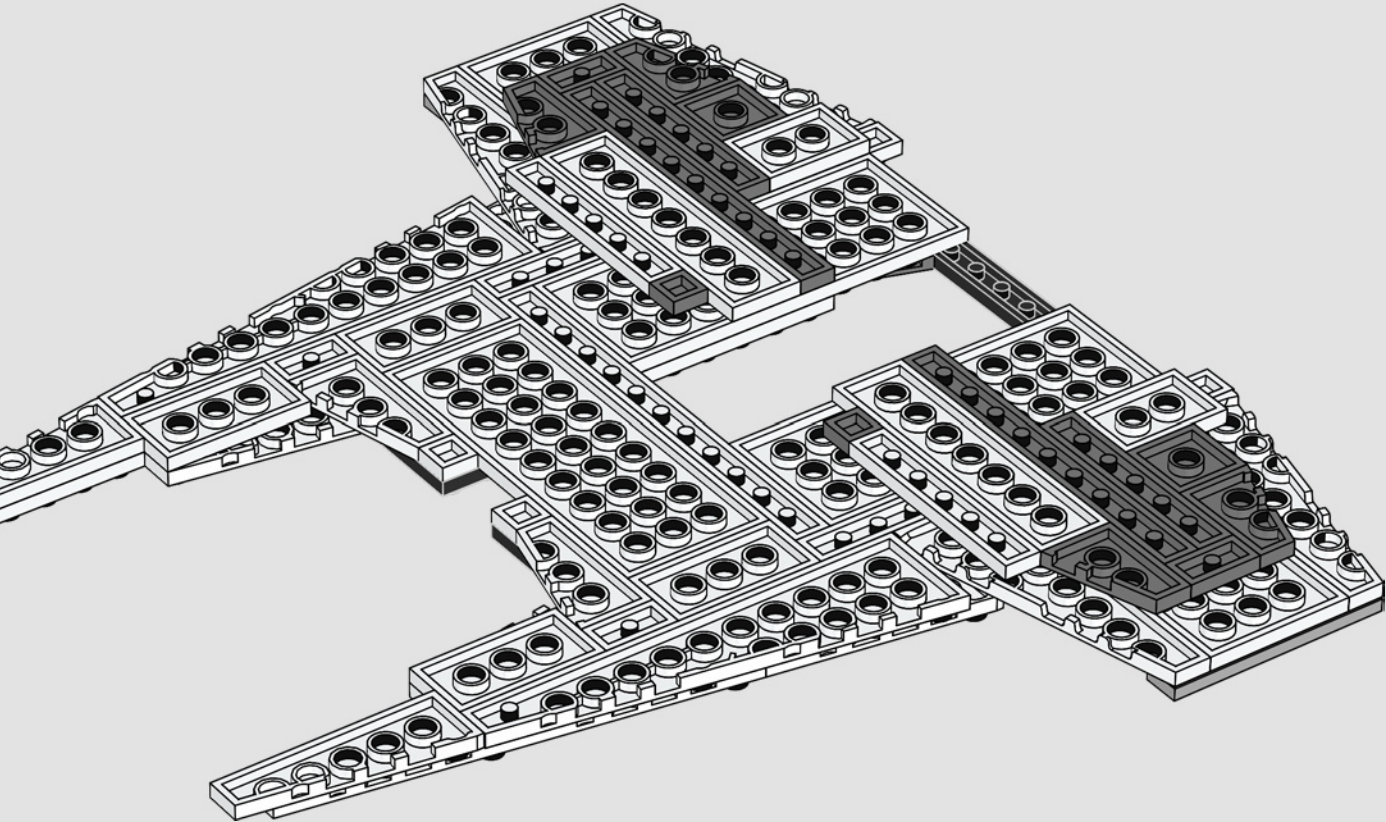



3x

34

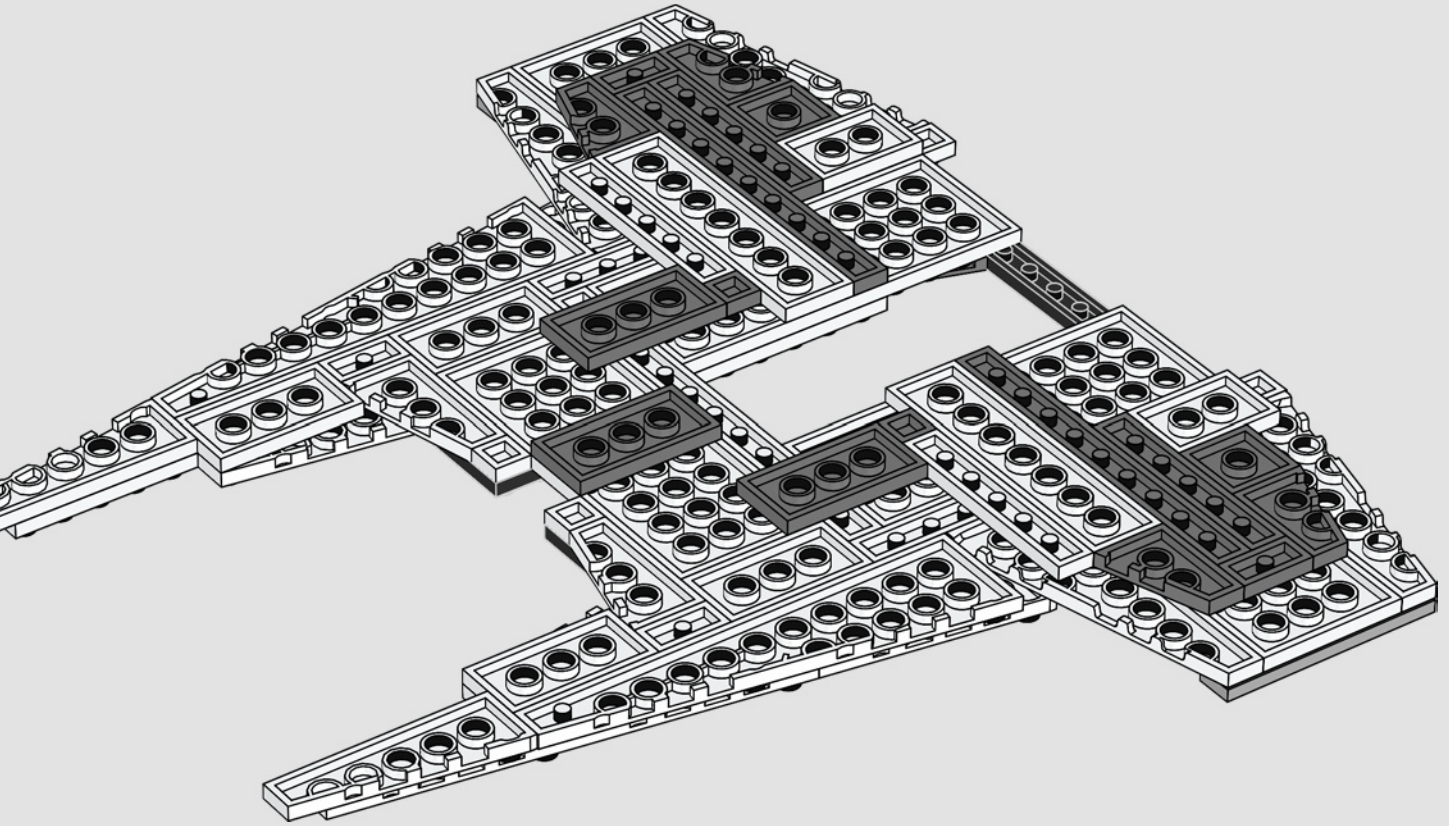



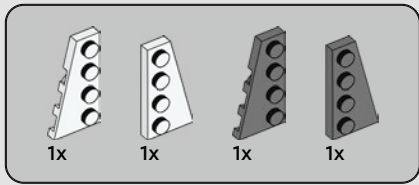

35

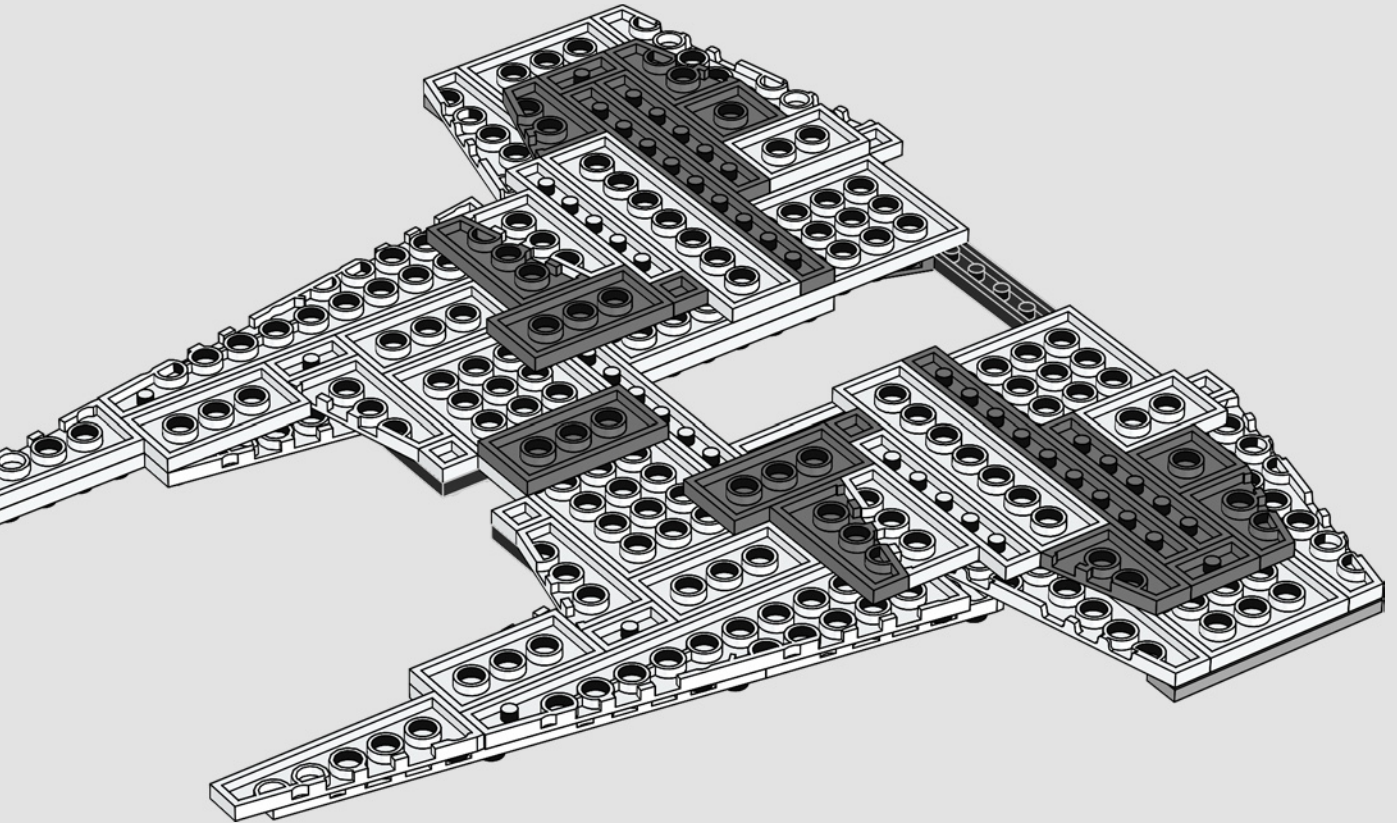

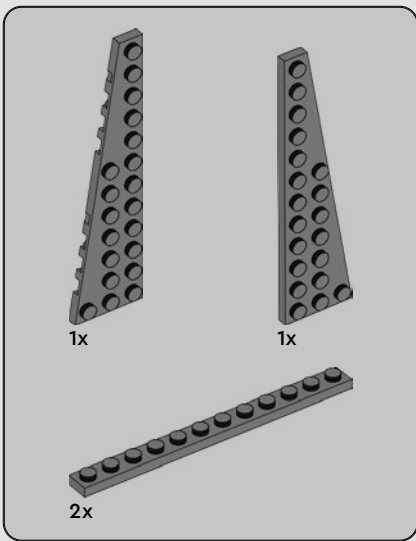

36

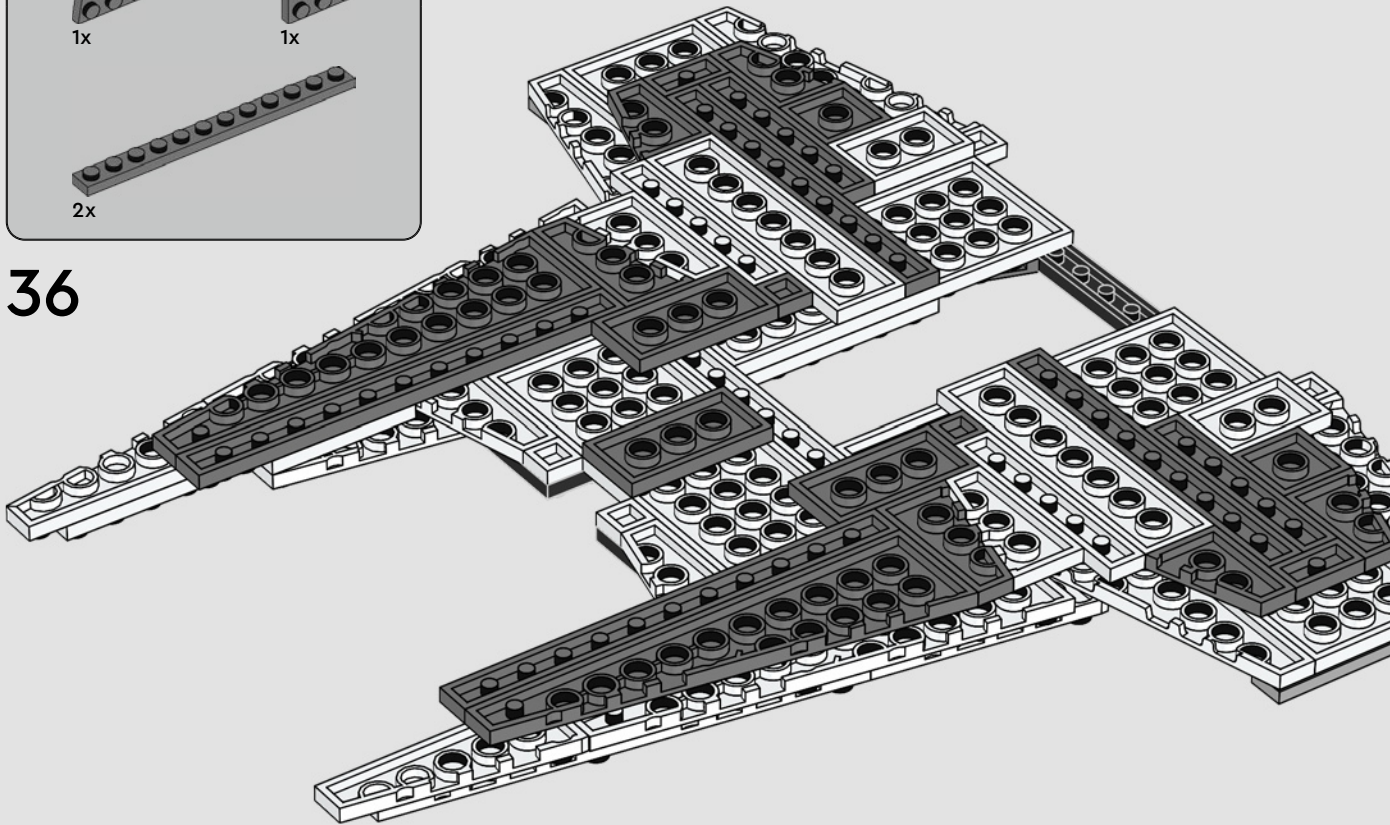



1x



1x

# 37

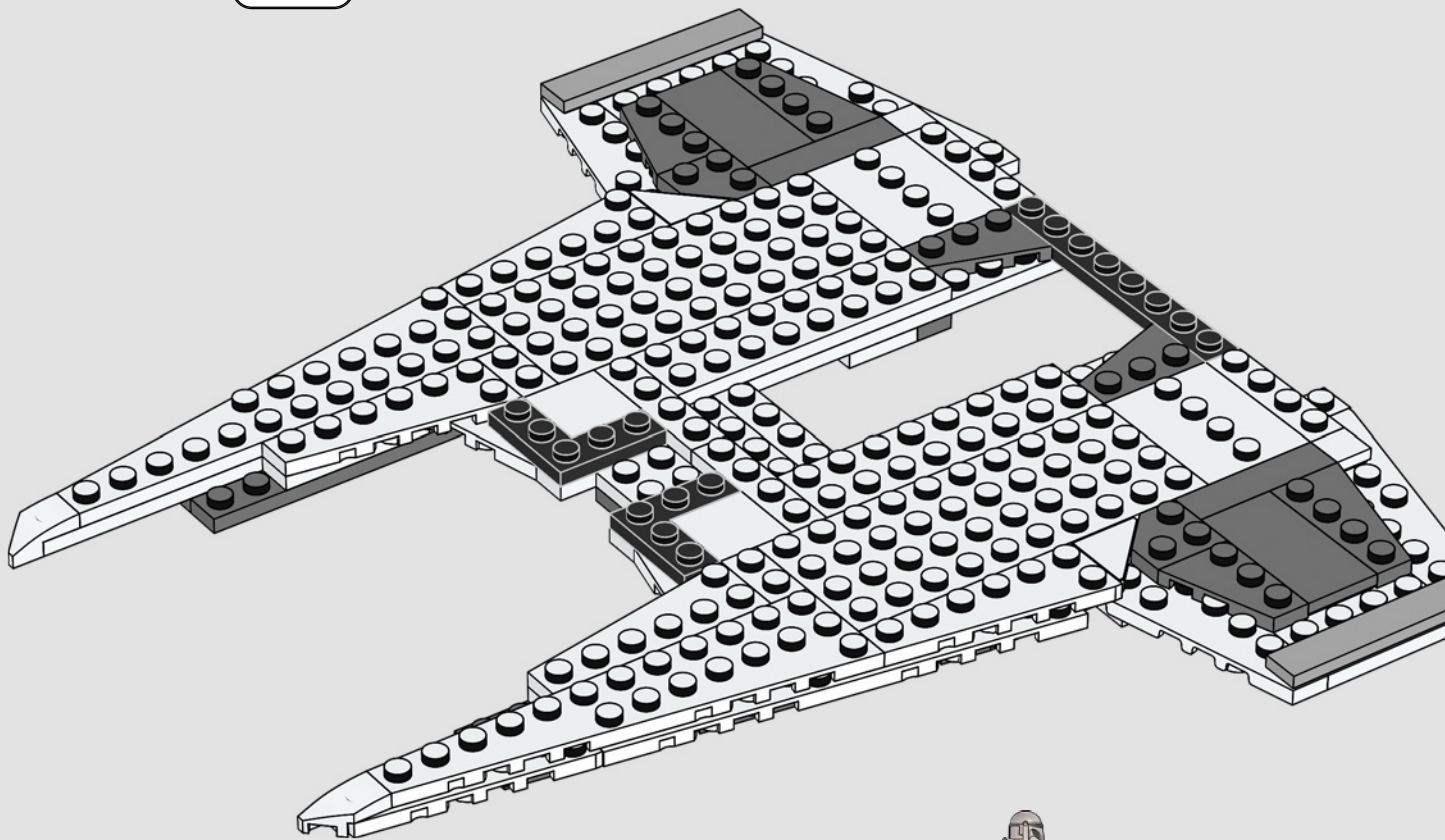



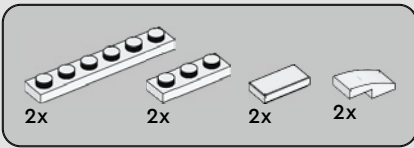

38

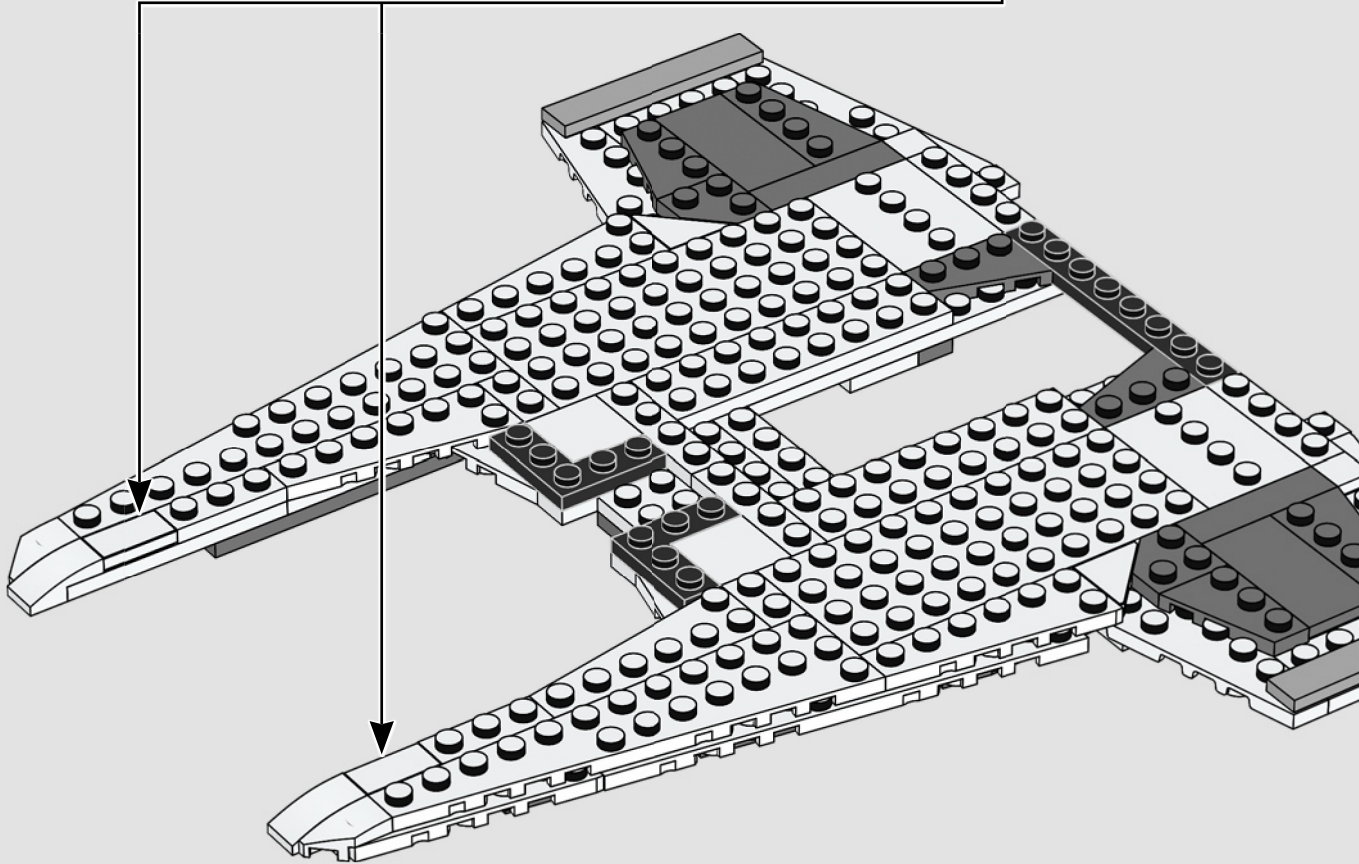
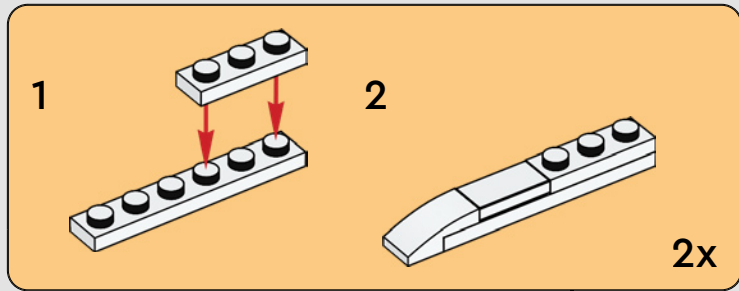



2x

39

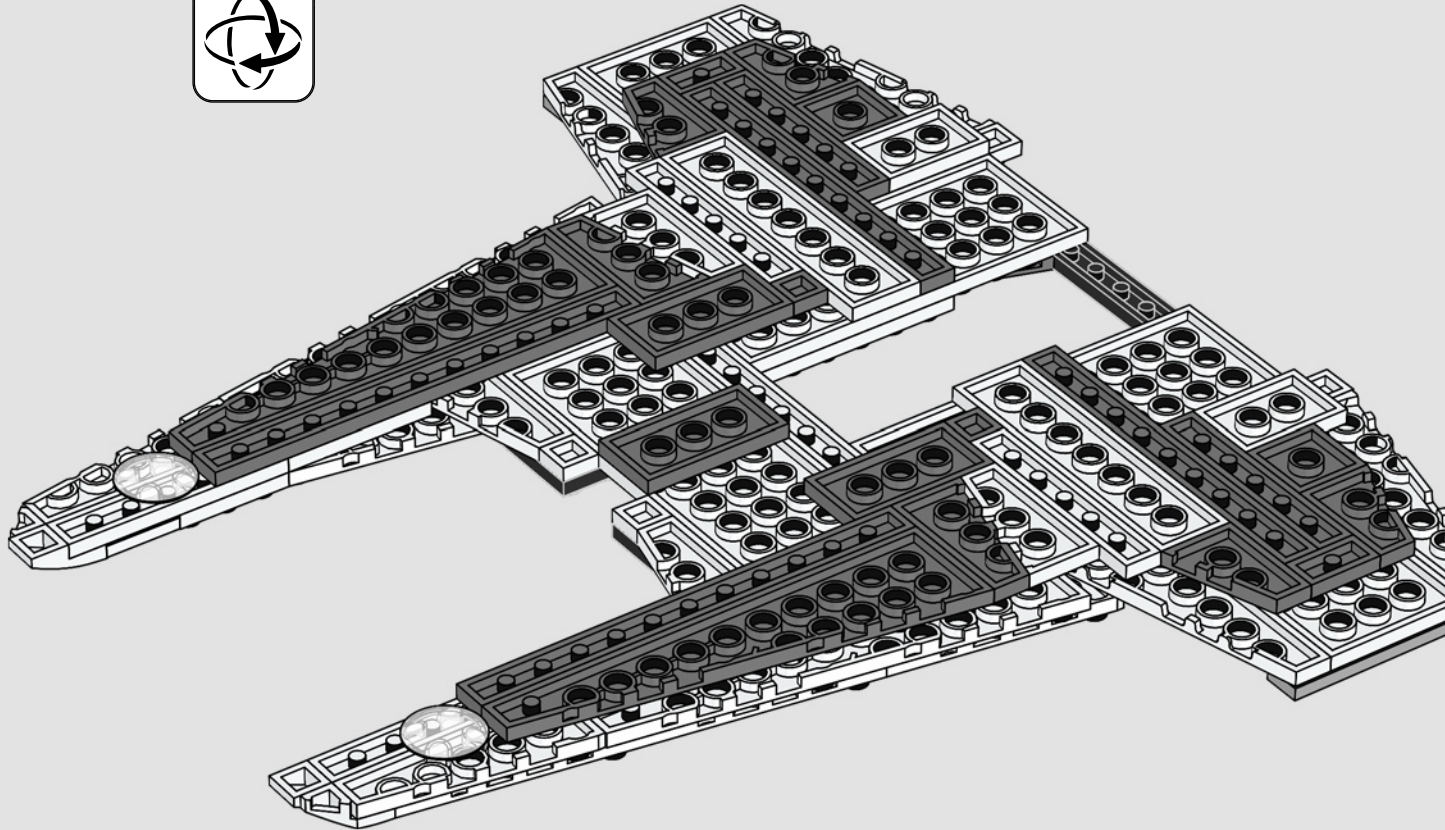







1x



1x

40

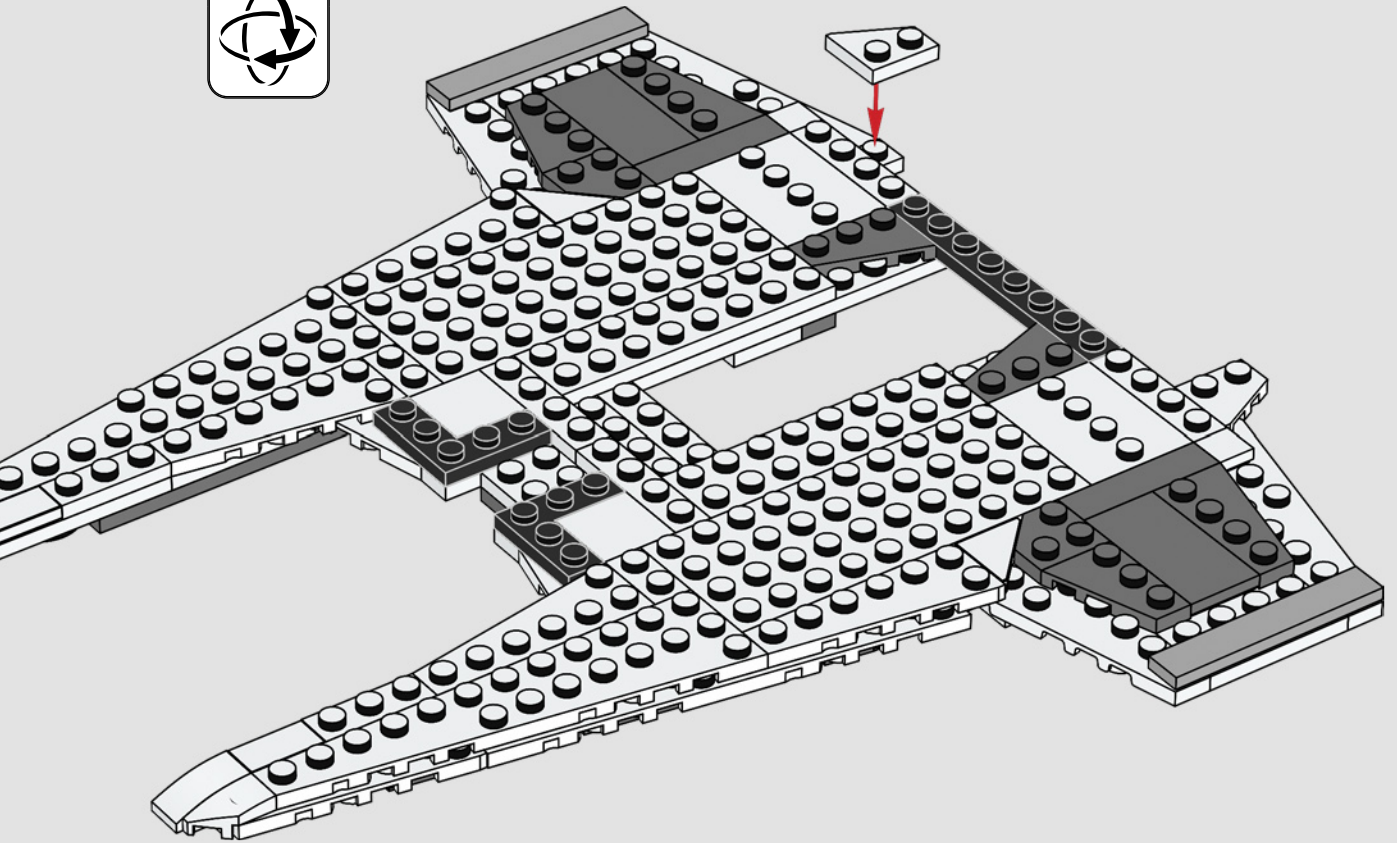

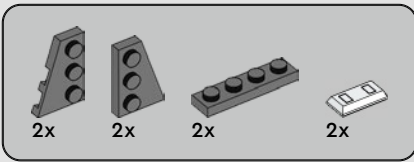

41

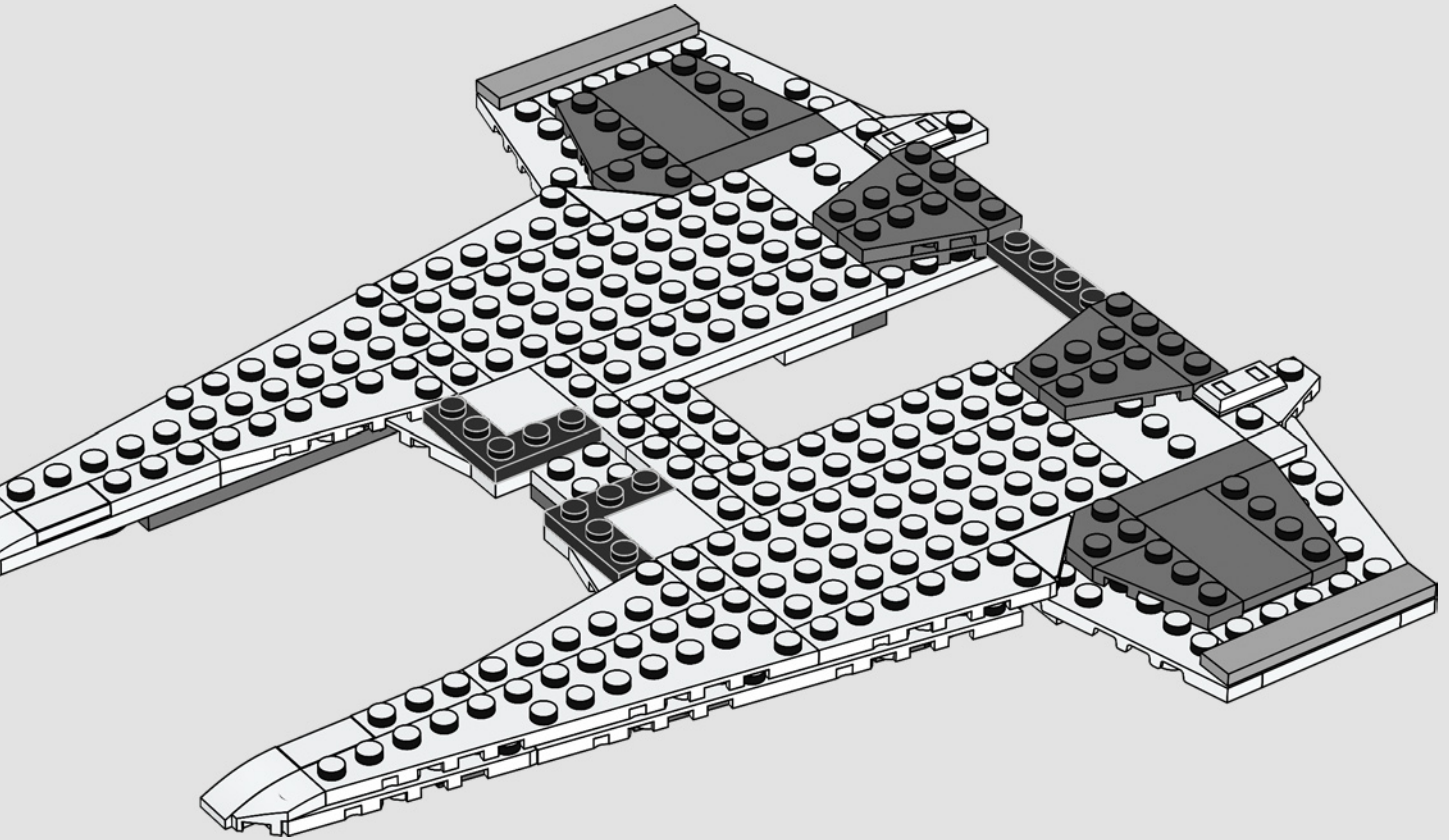

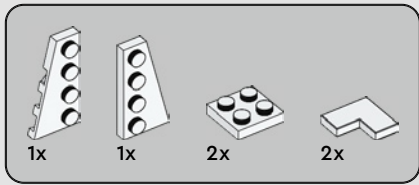

42

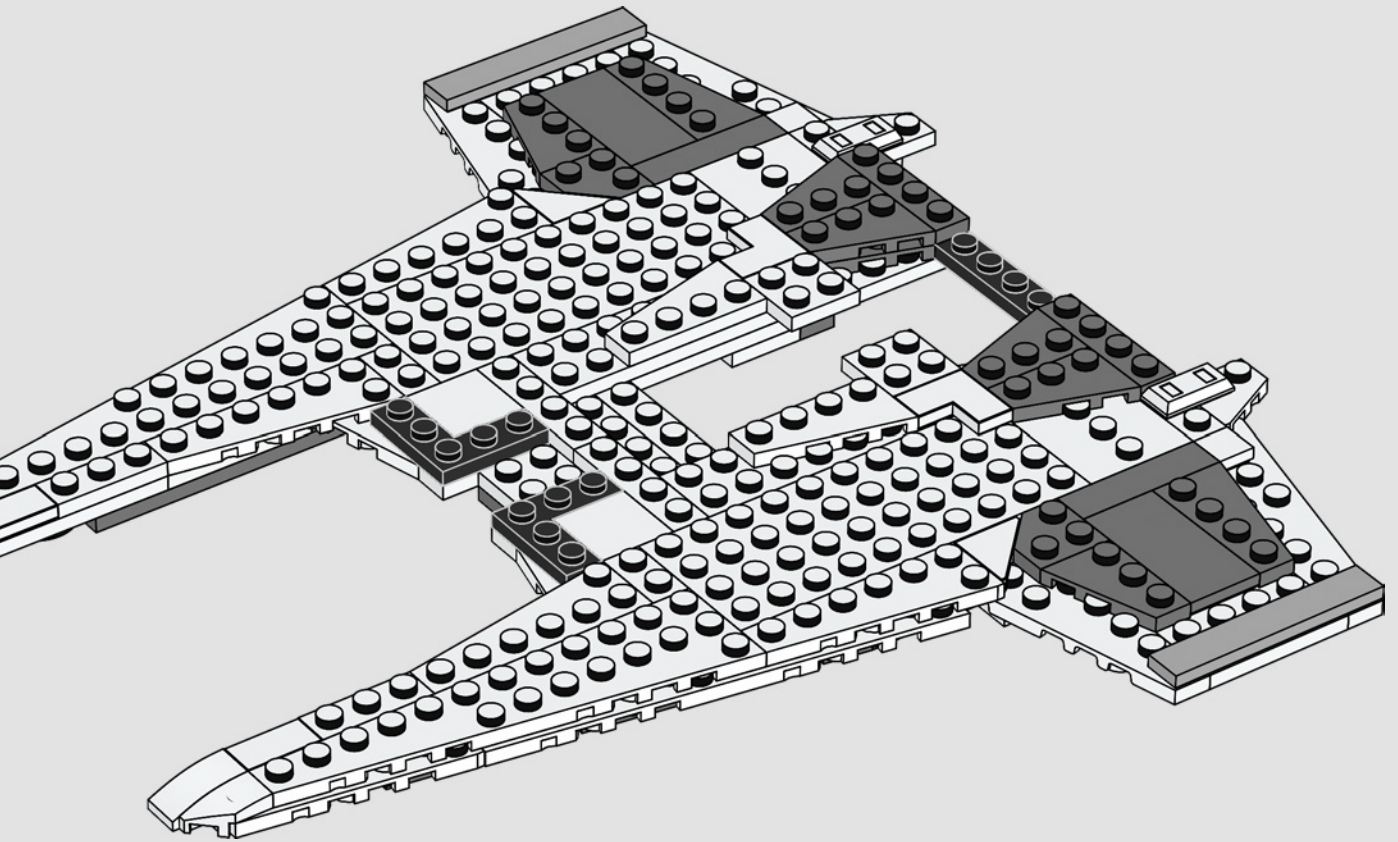

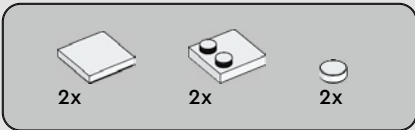

43

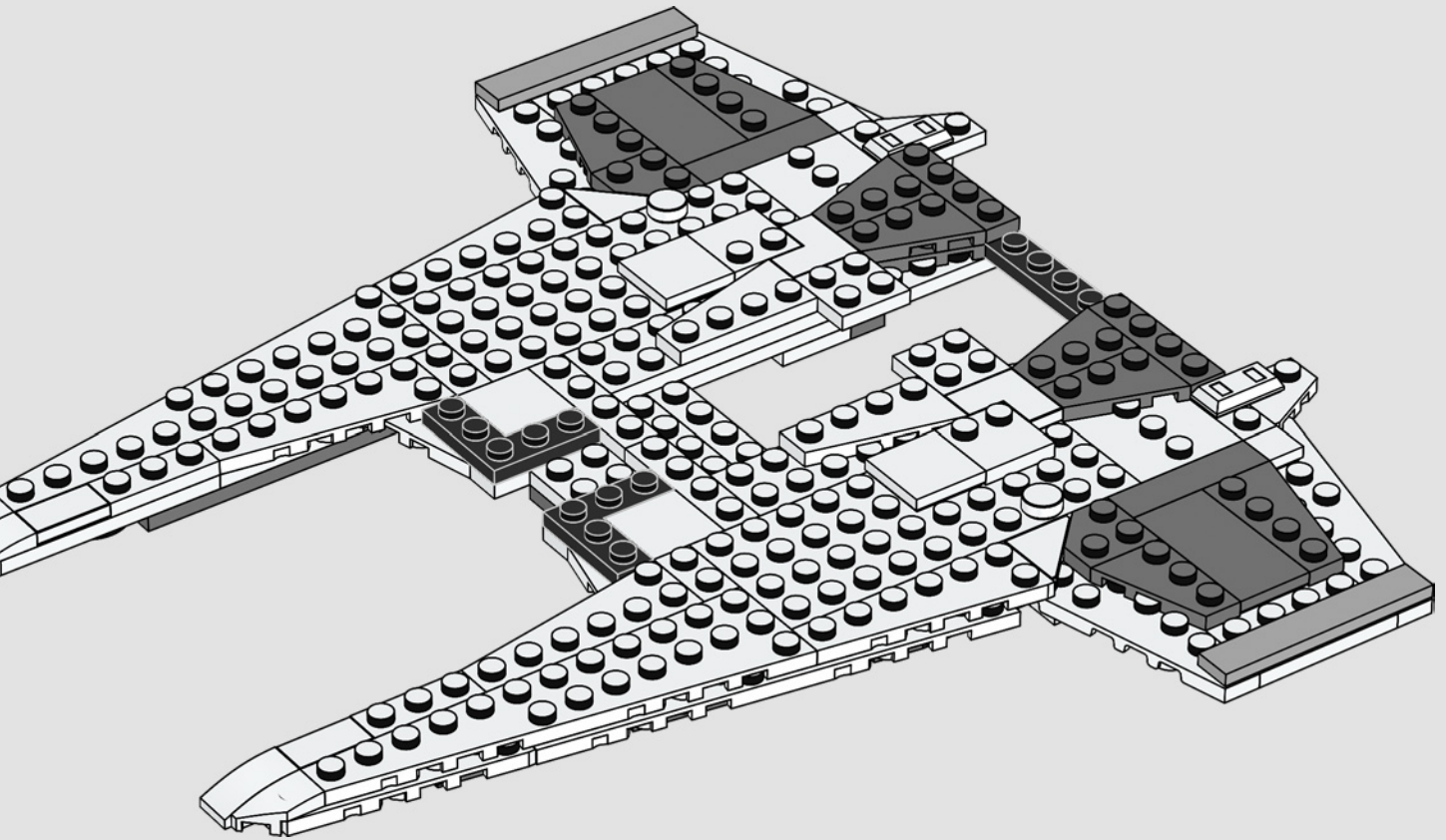



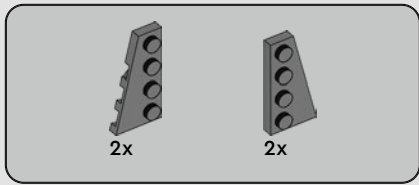

44

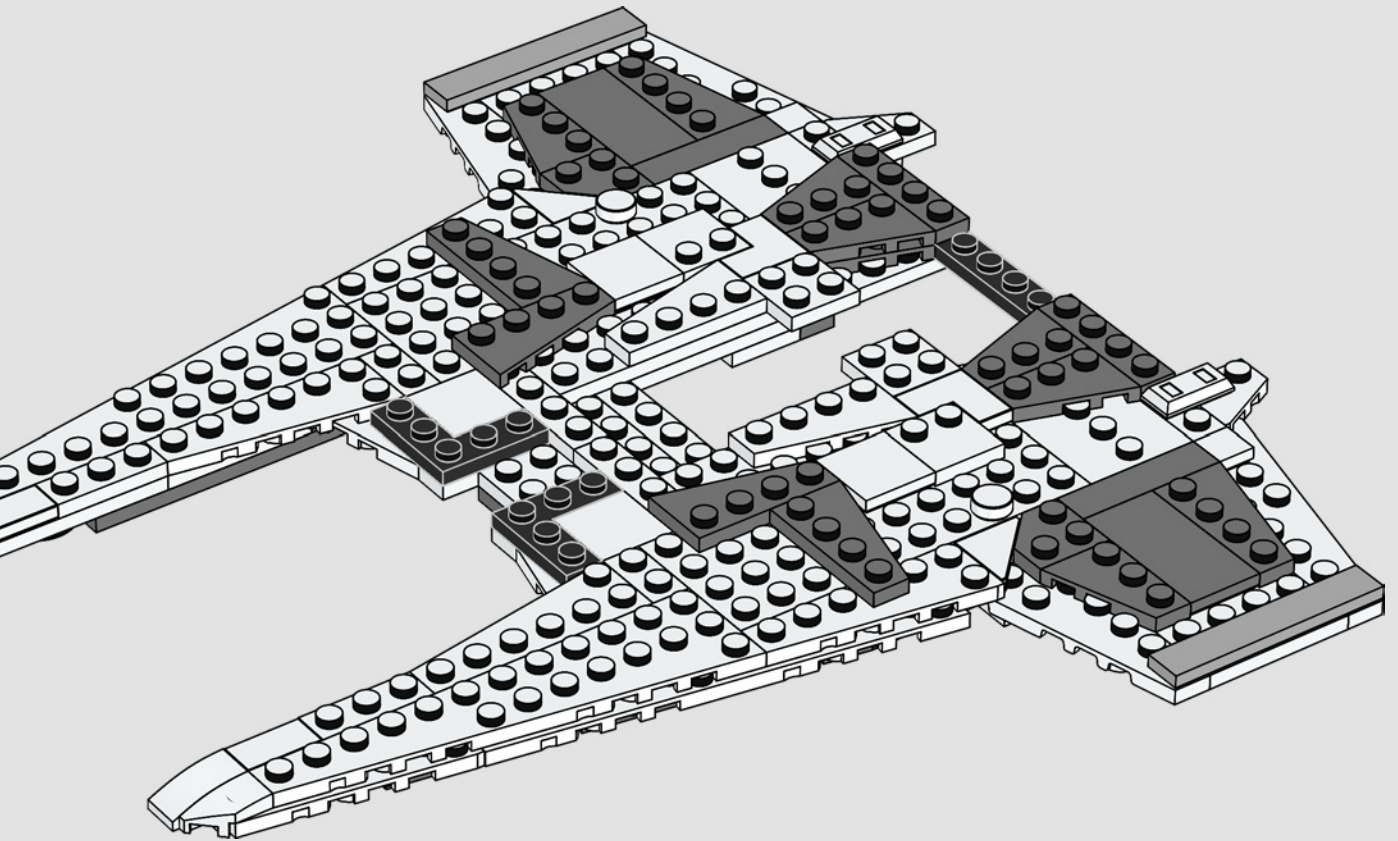

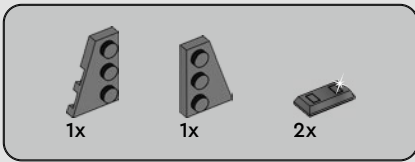

45

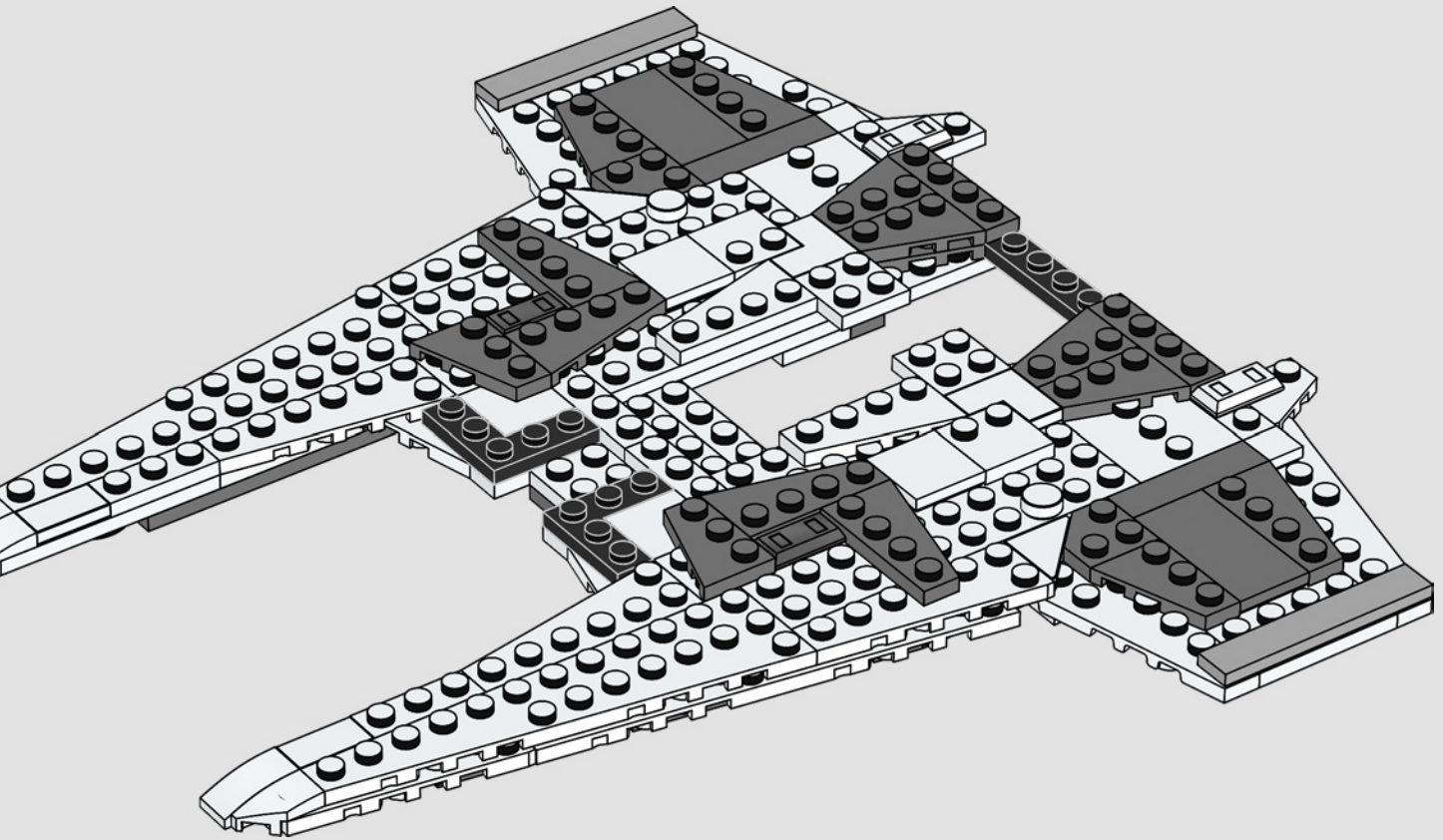

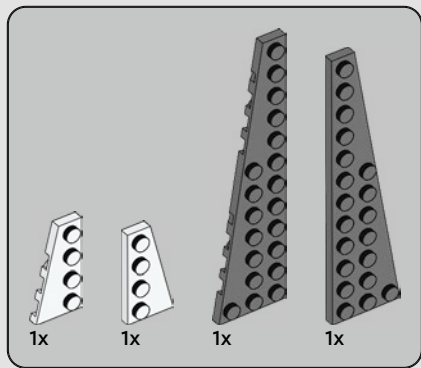

46

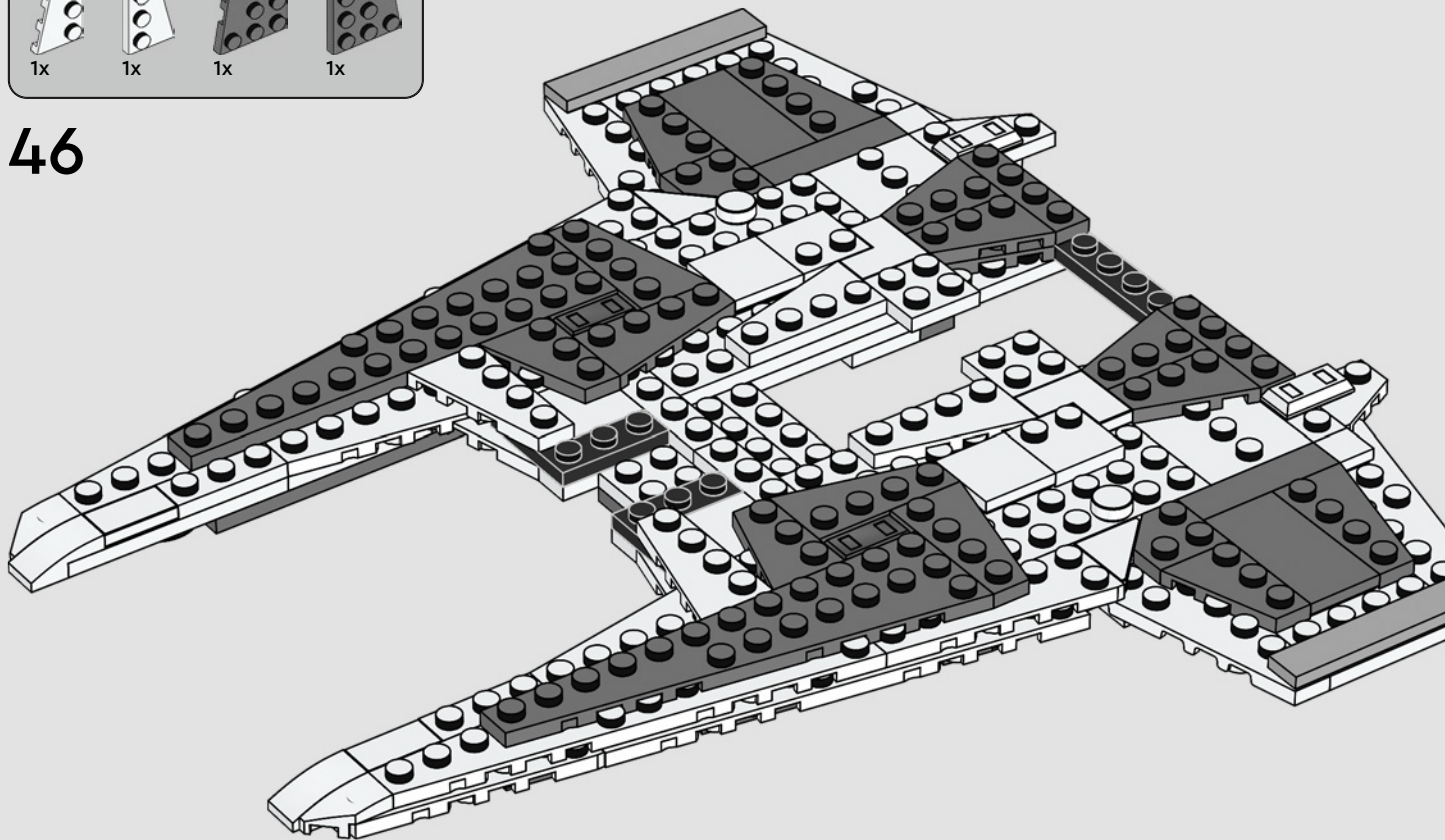



2x



2x

47

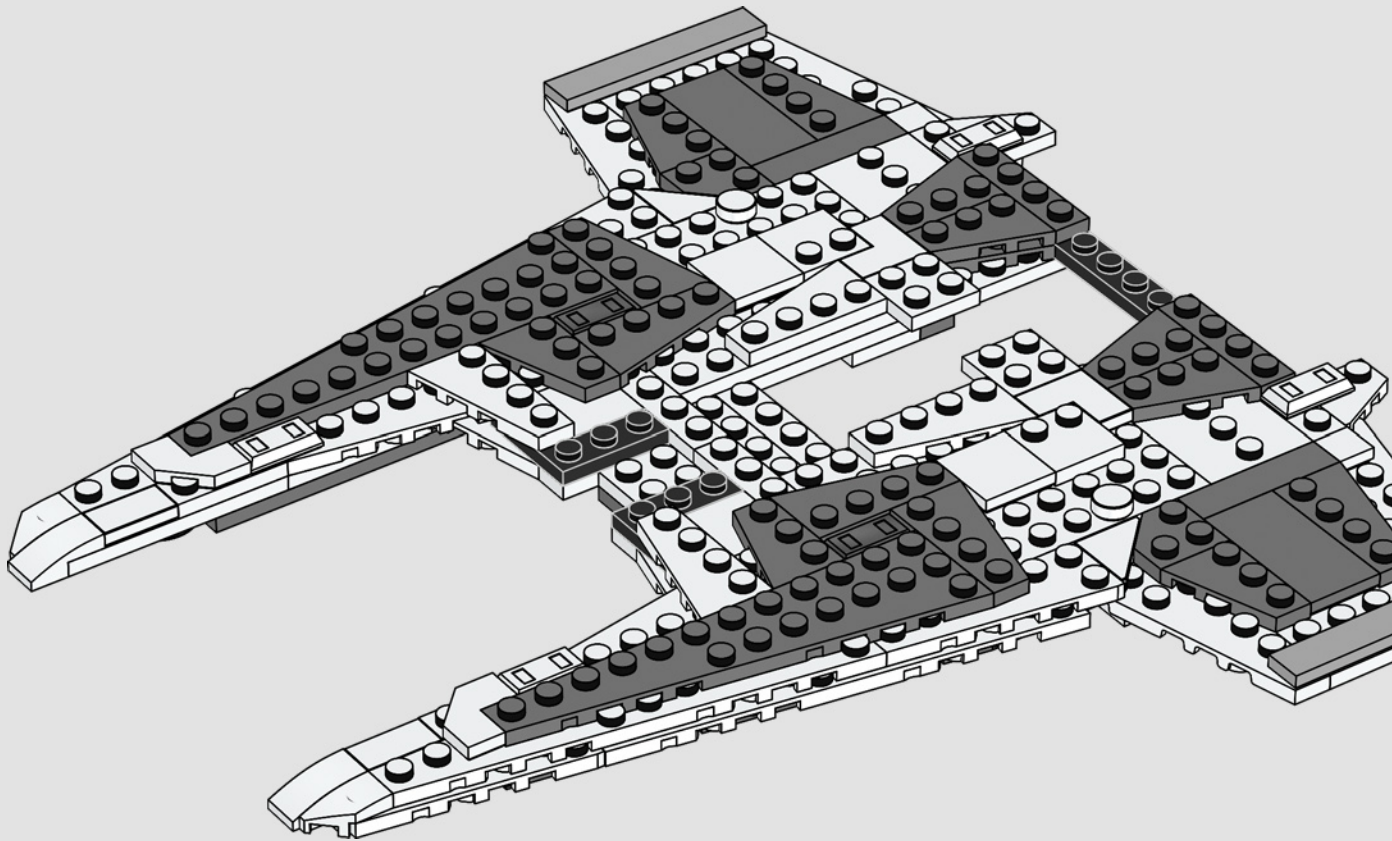





2x



2x

48

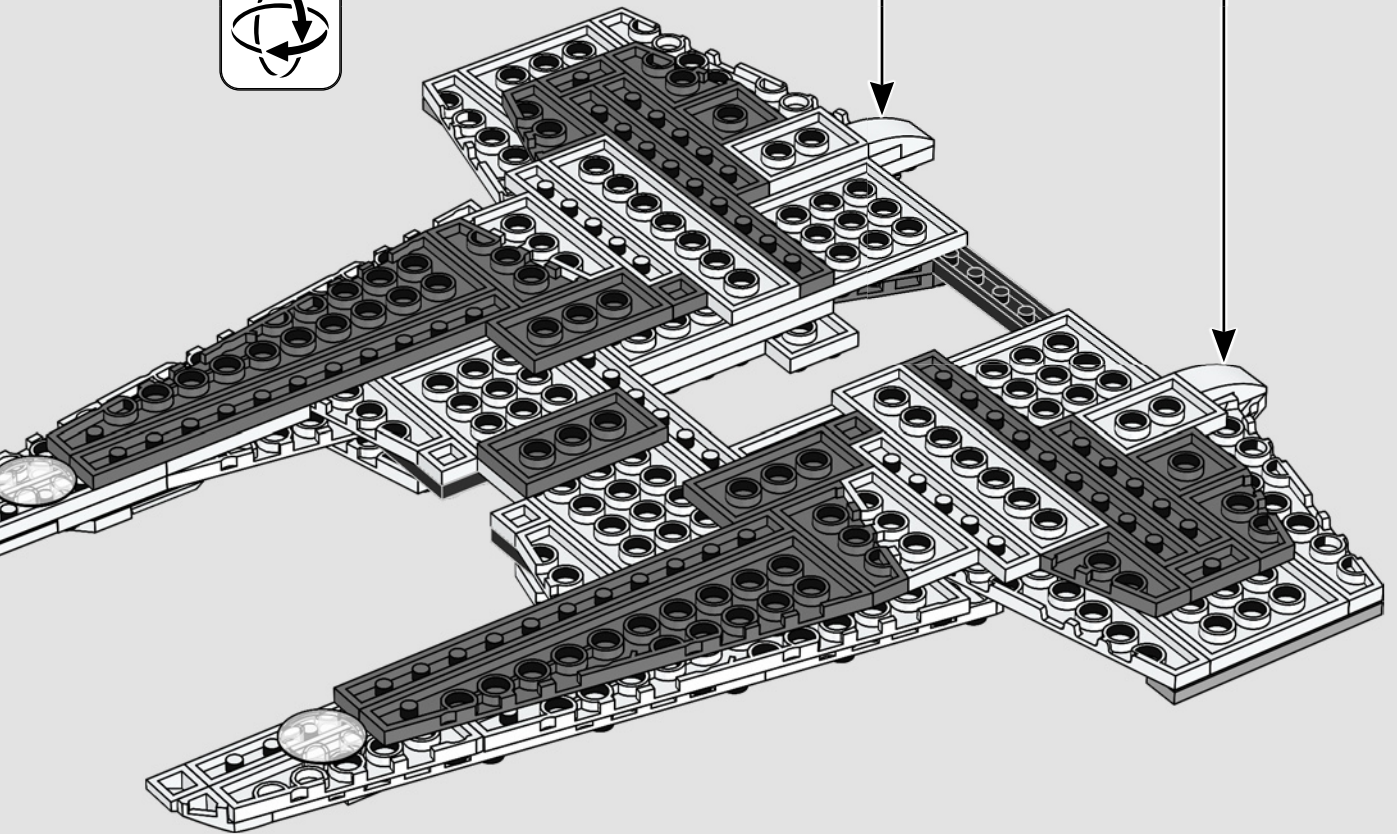



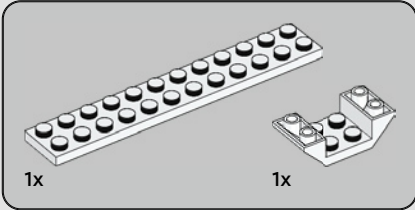
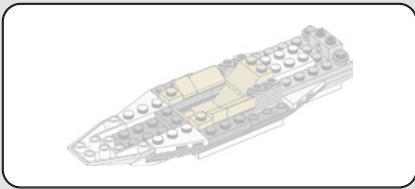

49

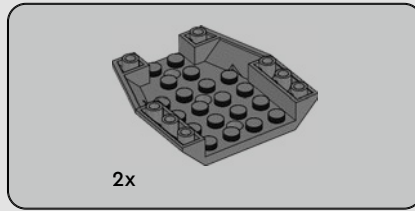
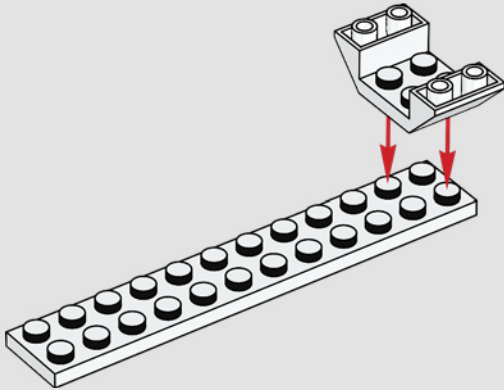

50

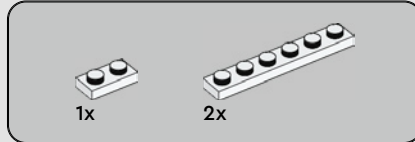
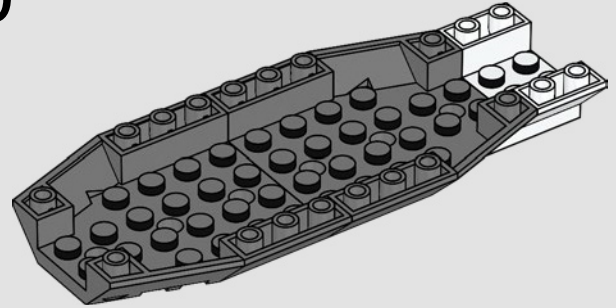

51

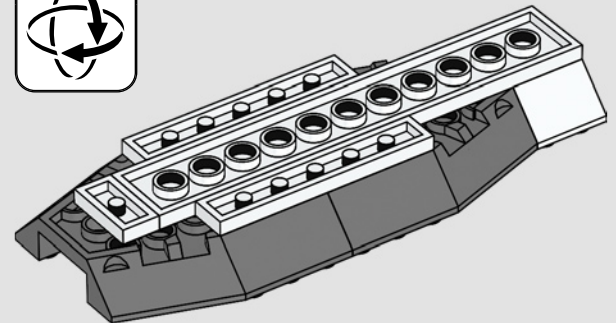
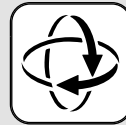

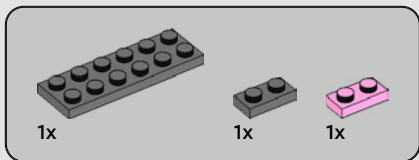

52

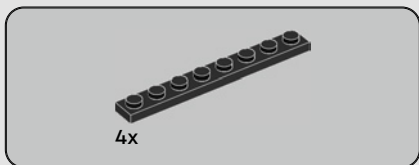
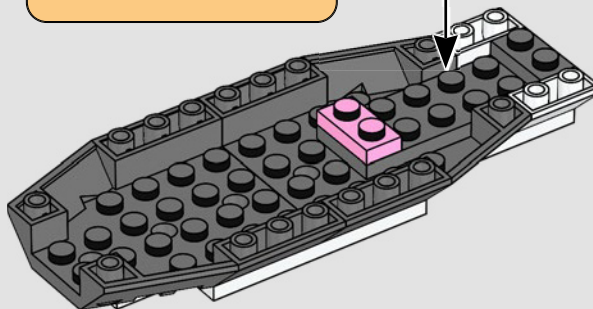
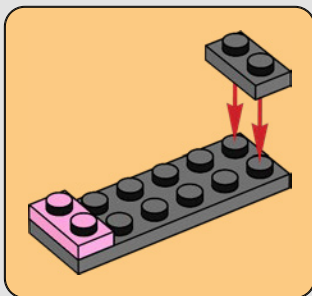

53

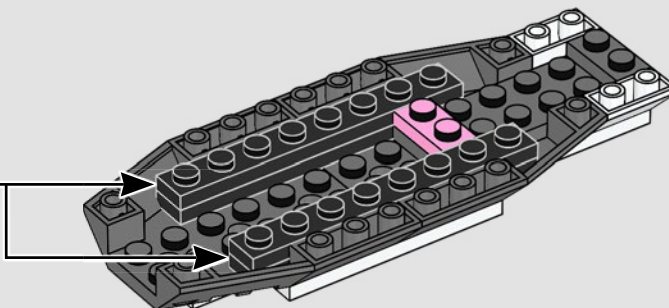
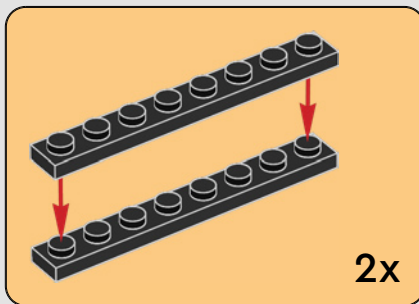

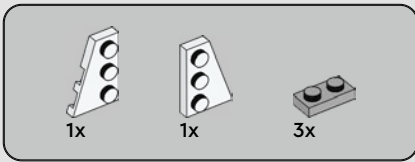

54

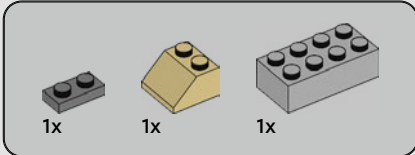
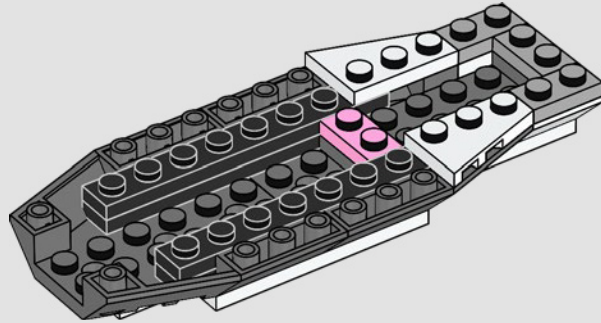

55

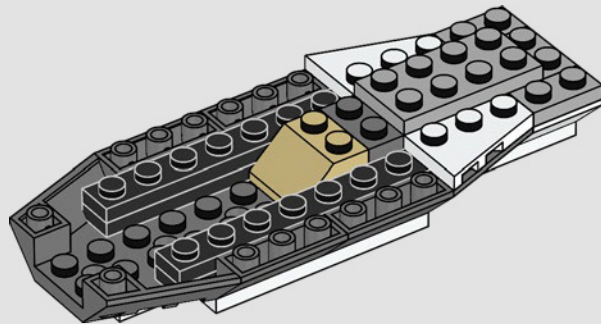

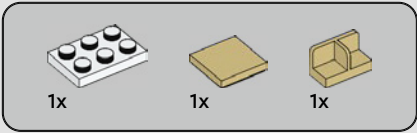

56

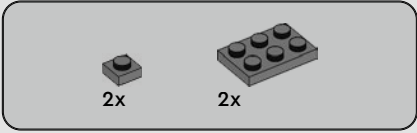
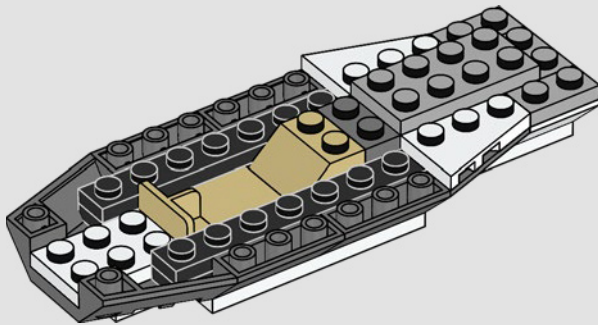

57

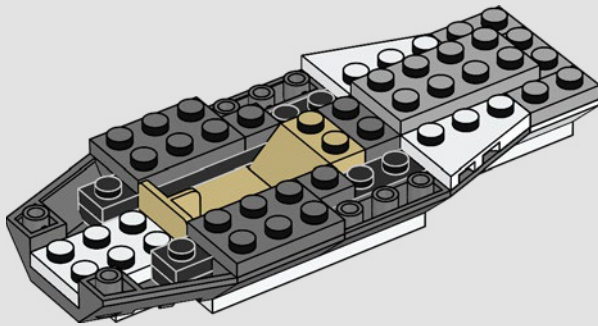



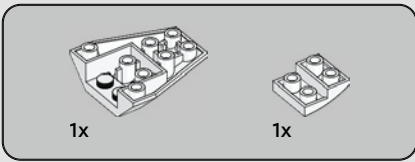

58

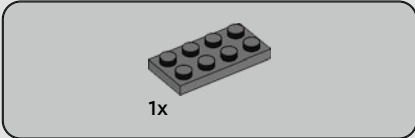
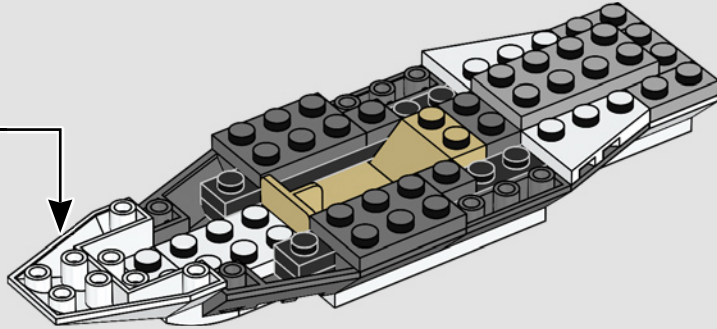
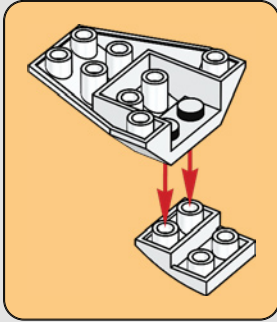

59

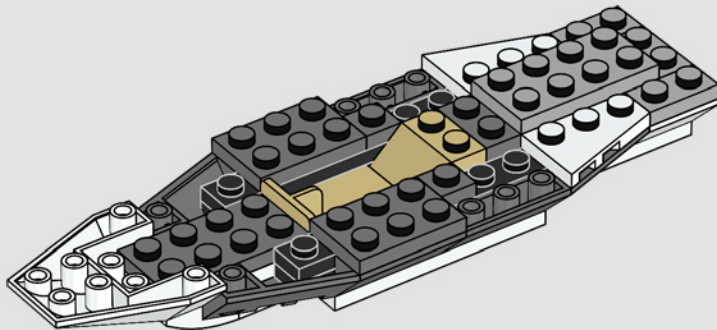

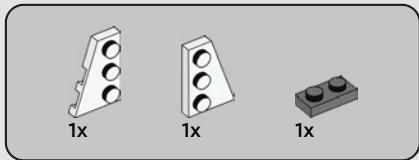

60

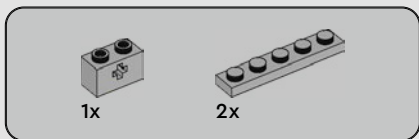
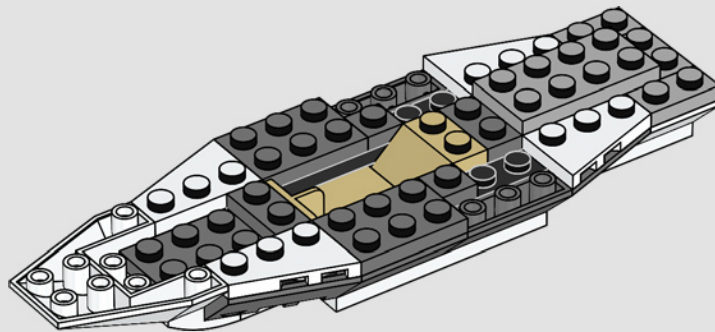

61

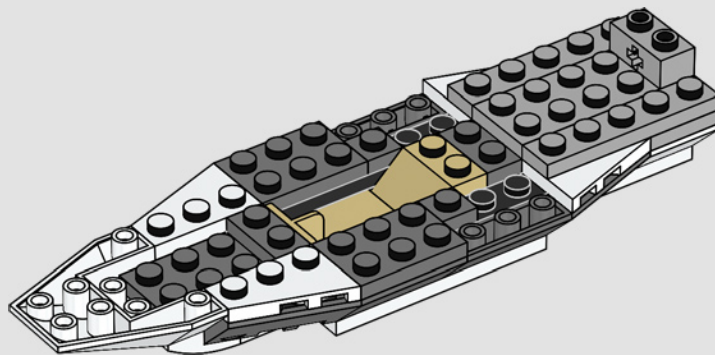



1x



2x

# 62

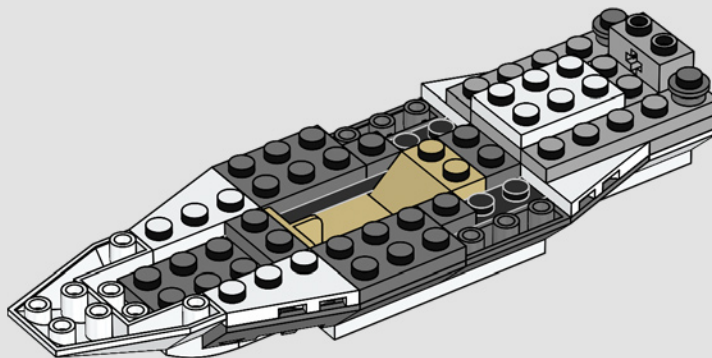

2x



1x

# 63

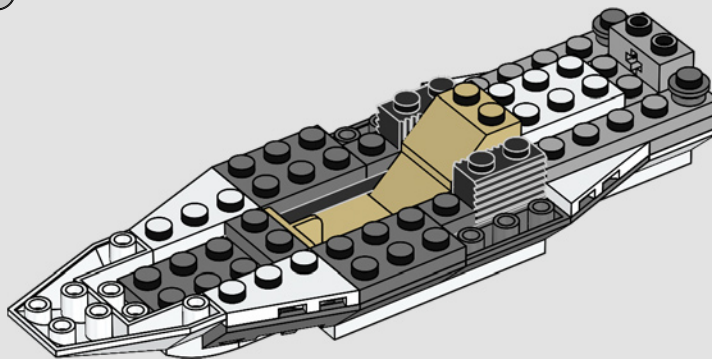



64

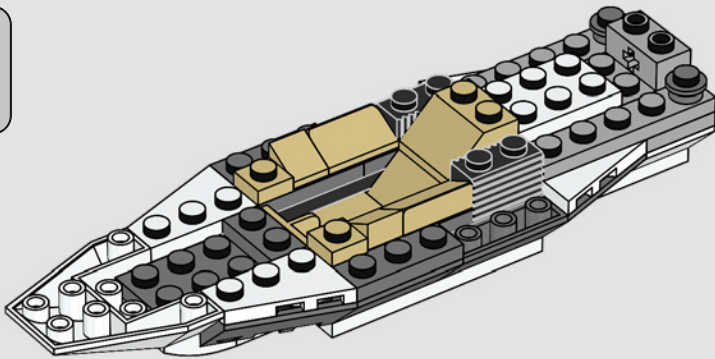

65

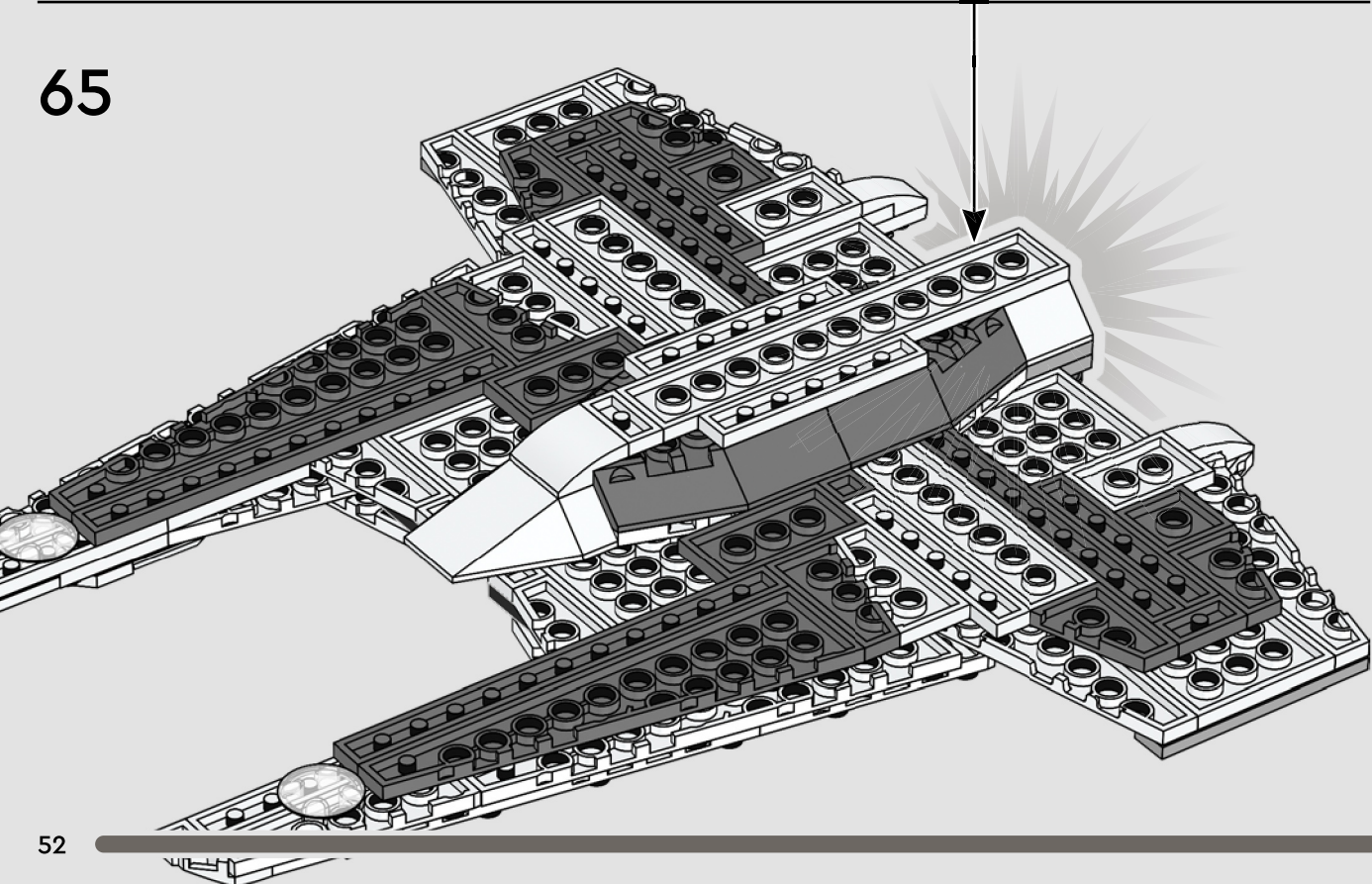



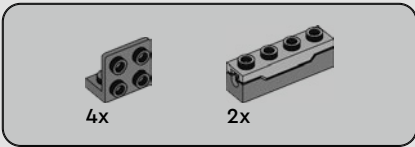

66

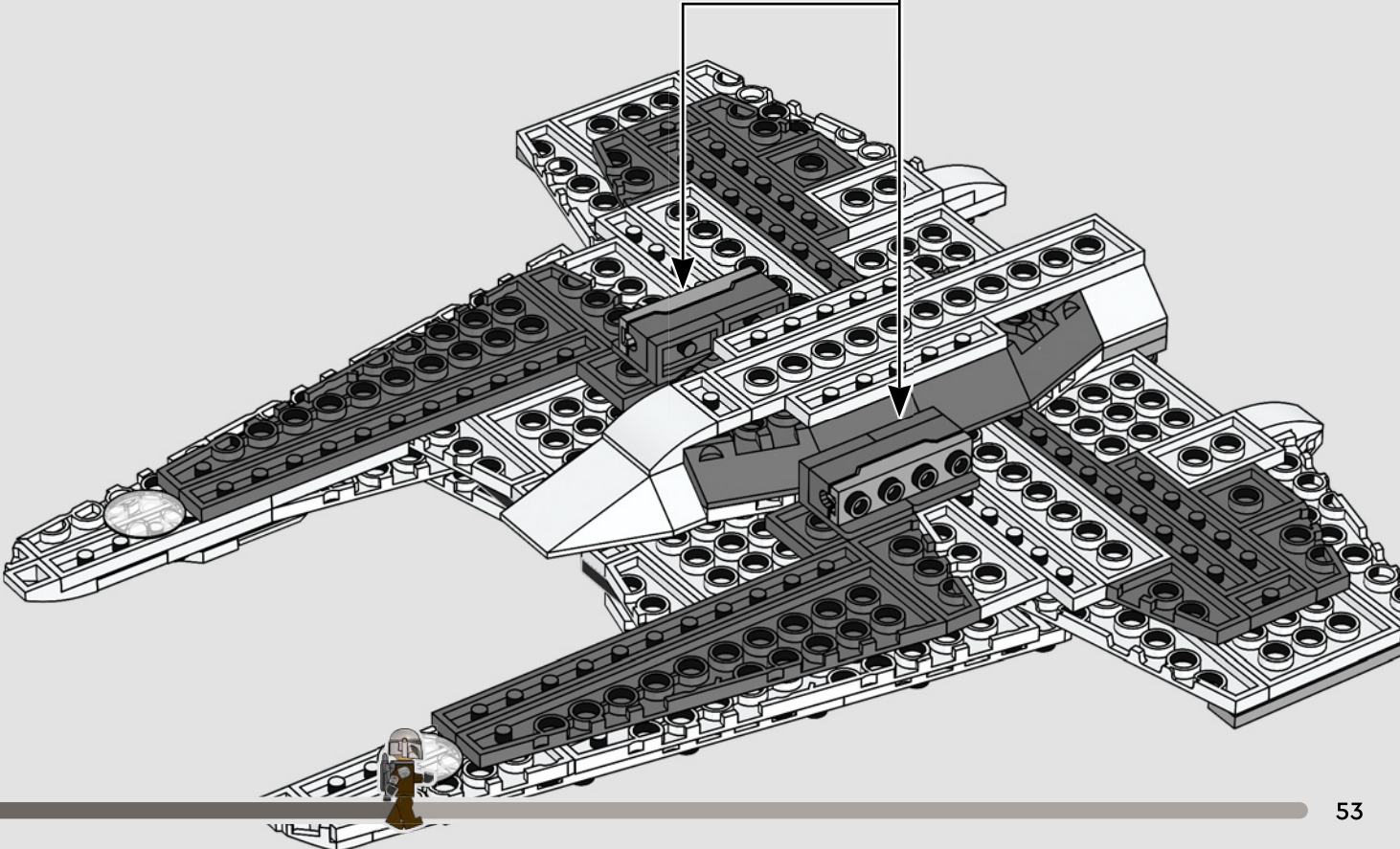
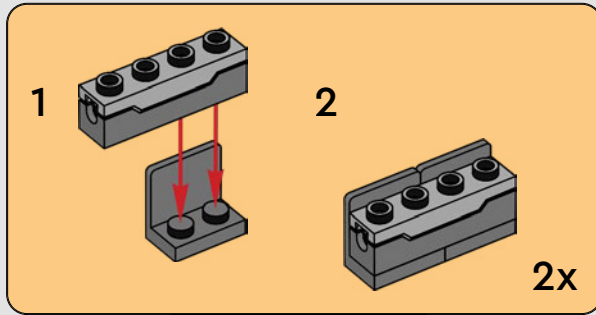

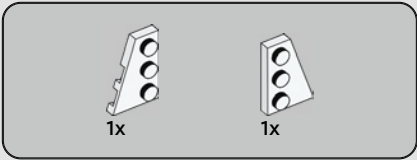

67

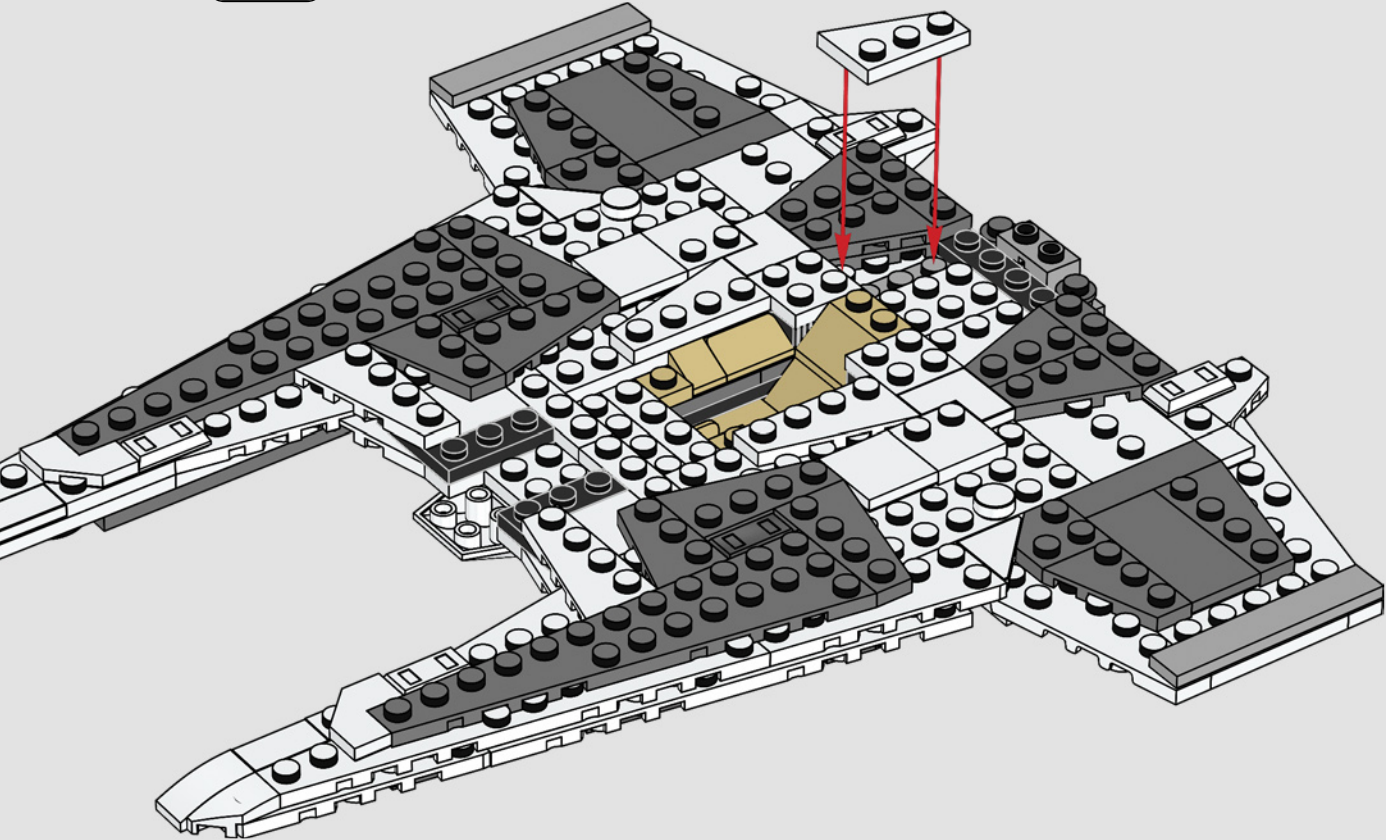

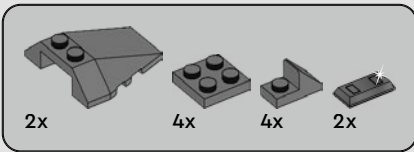

68

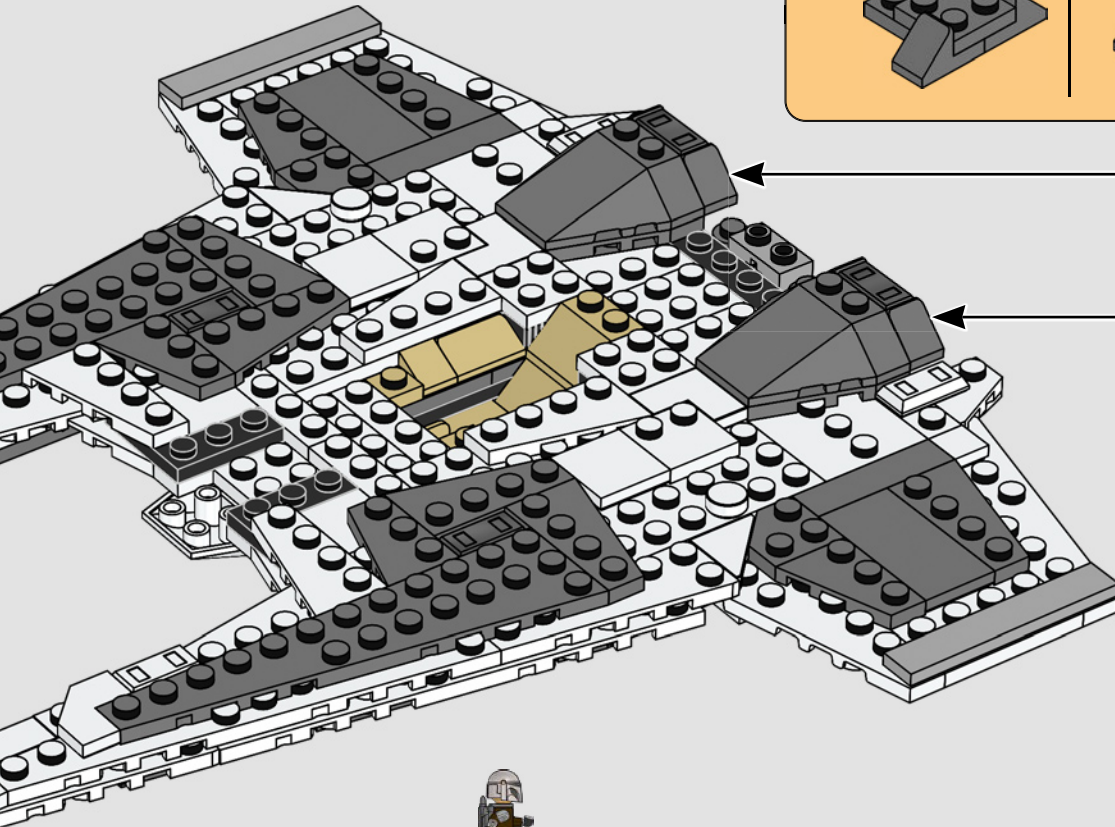
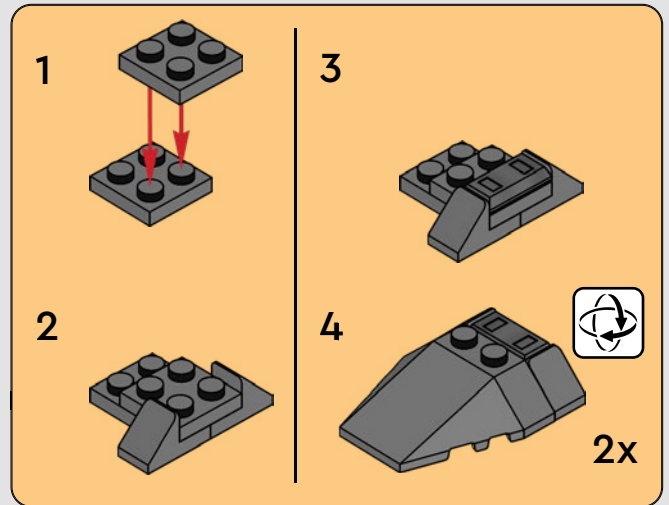



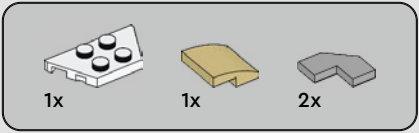

69

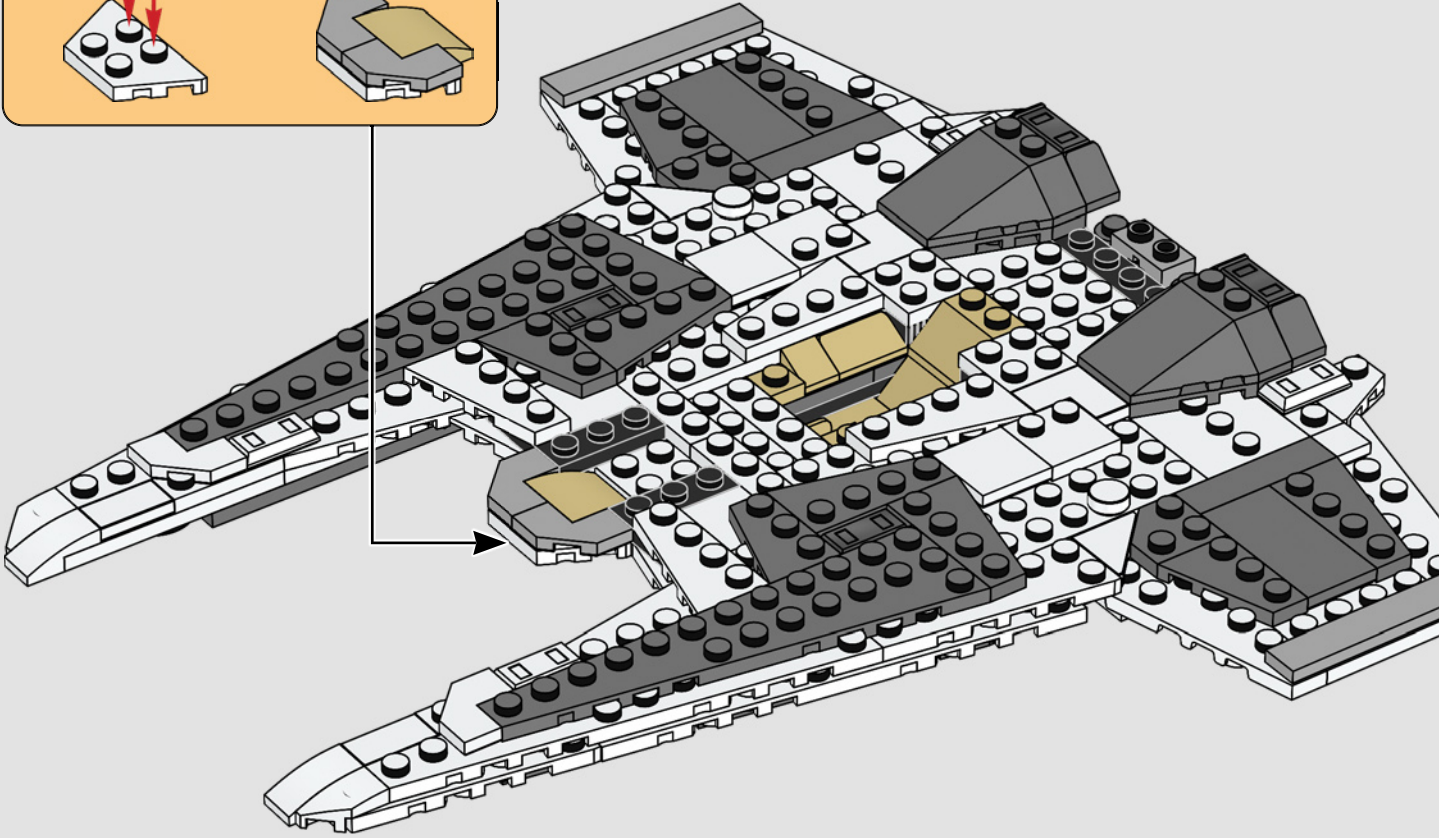
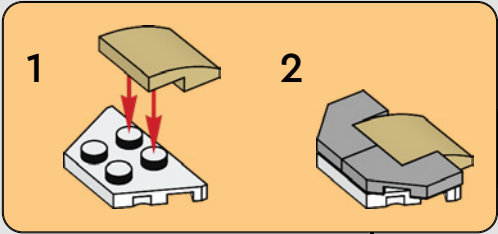



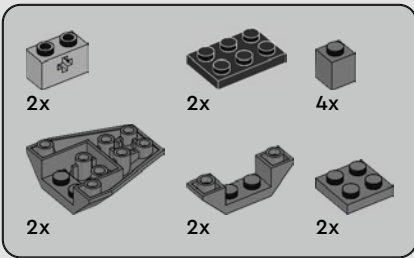

70

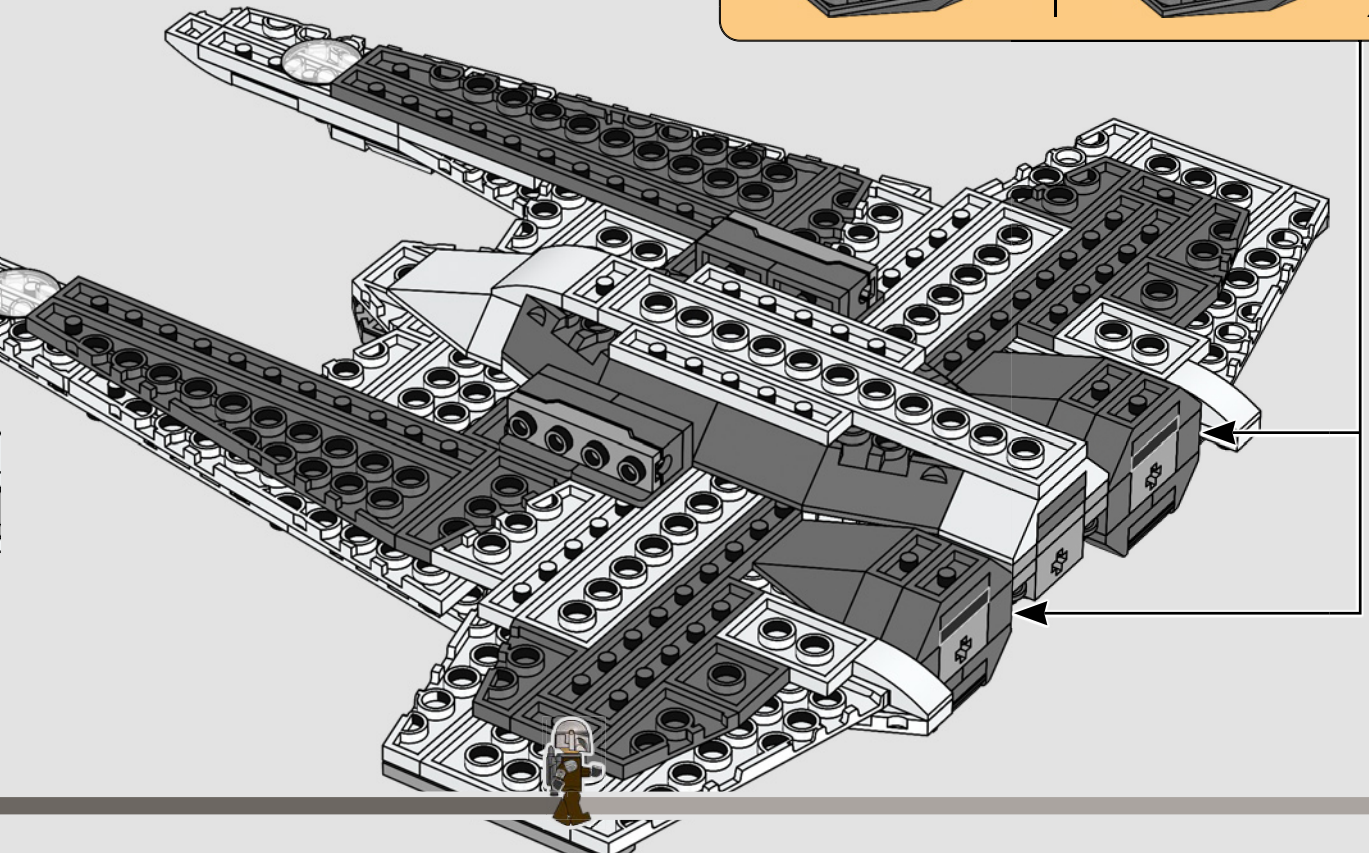
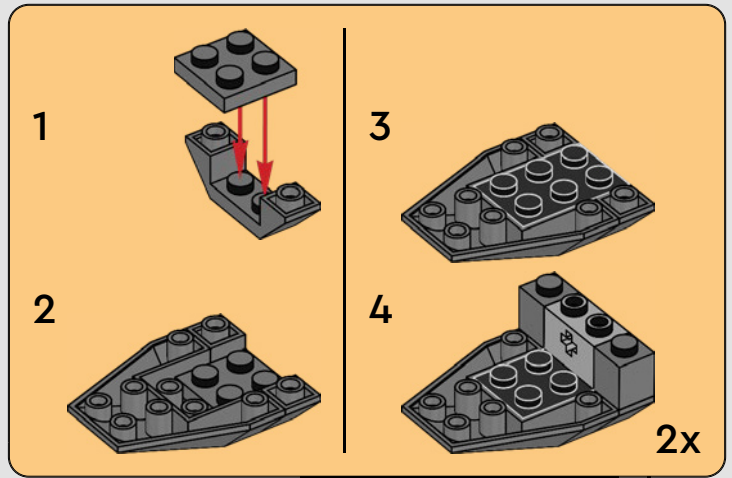

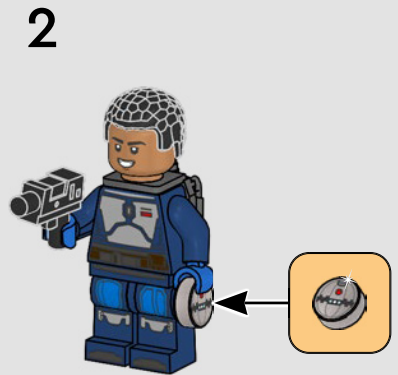
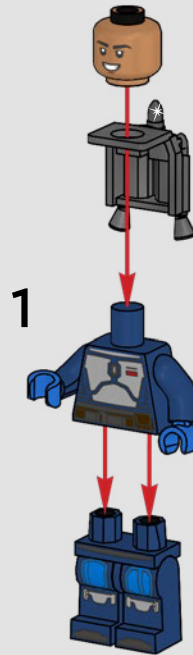

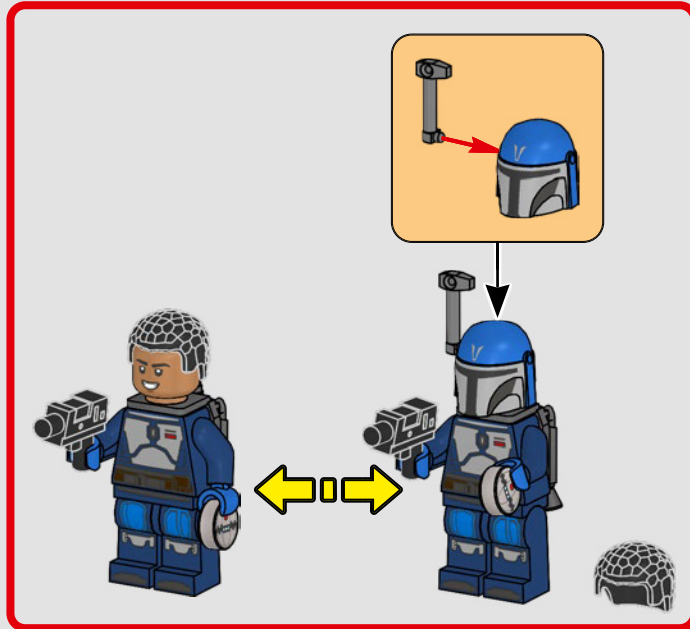



2x



1x

71

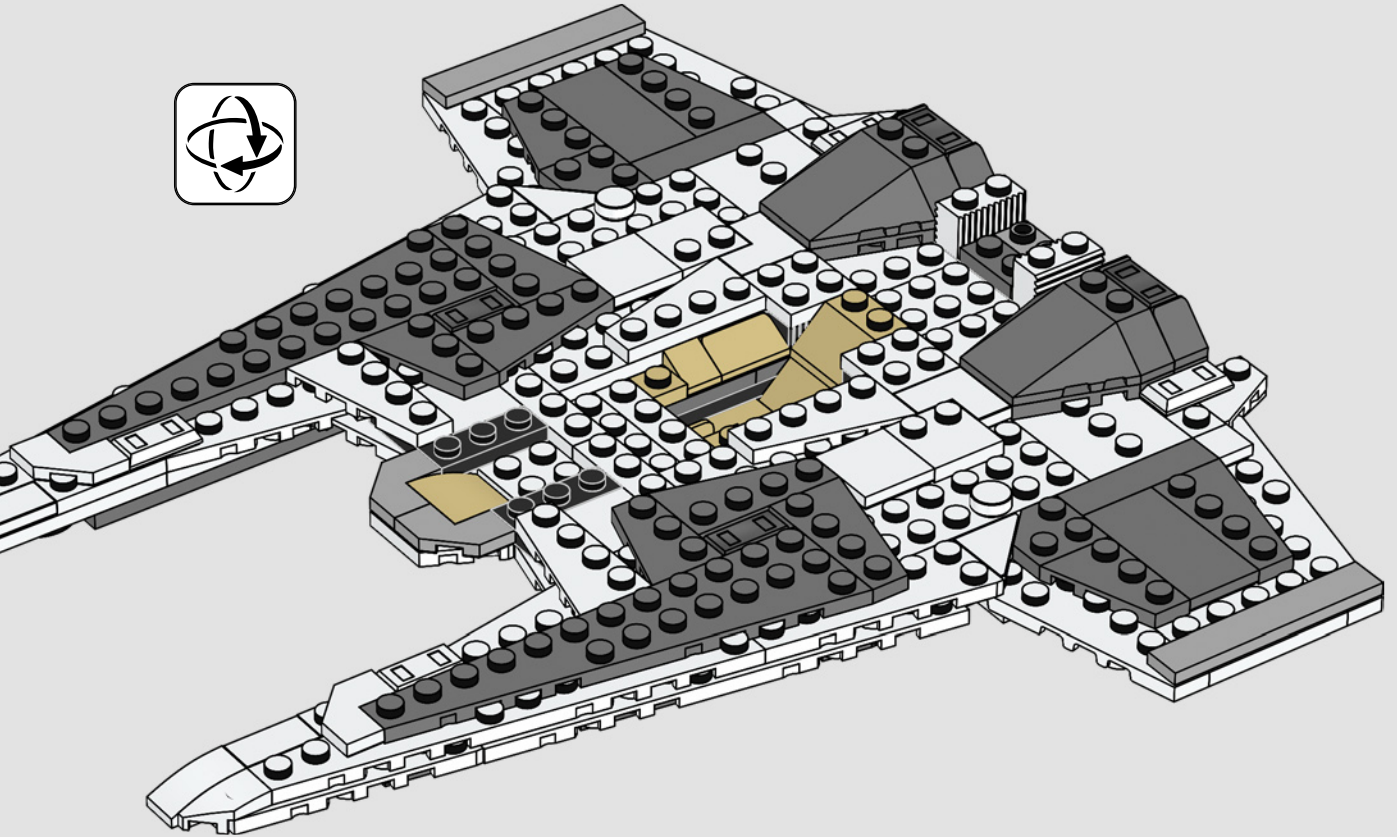





1x



2x

# 72

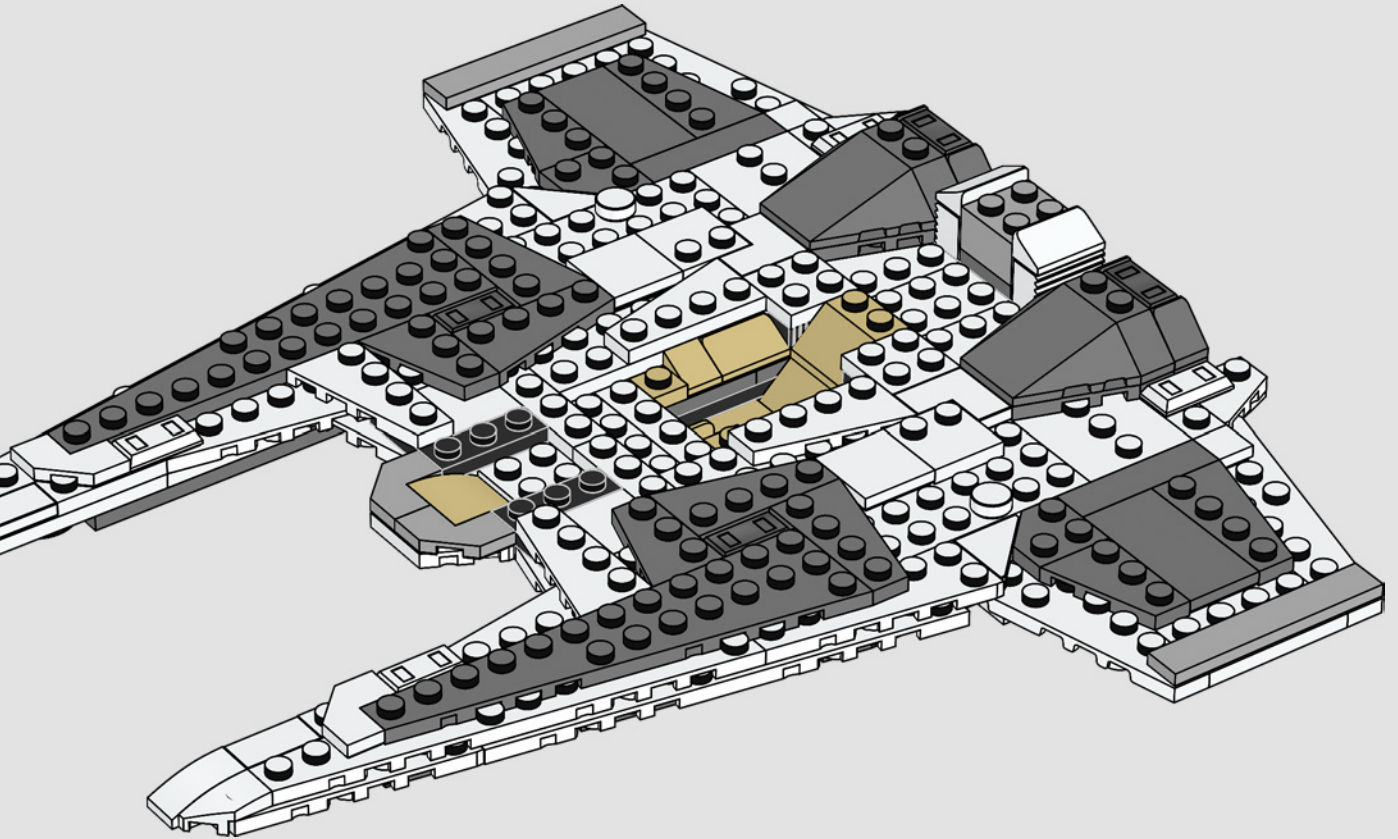

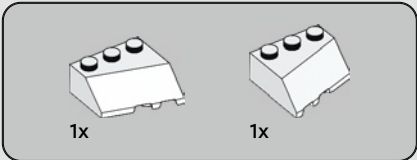

# 73

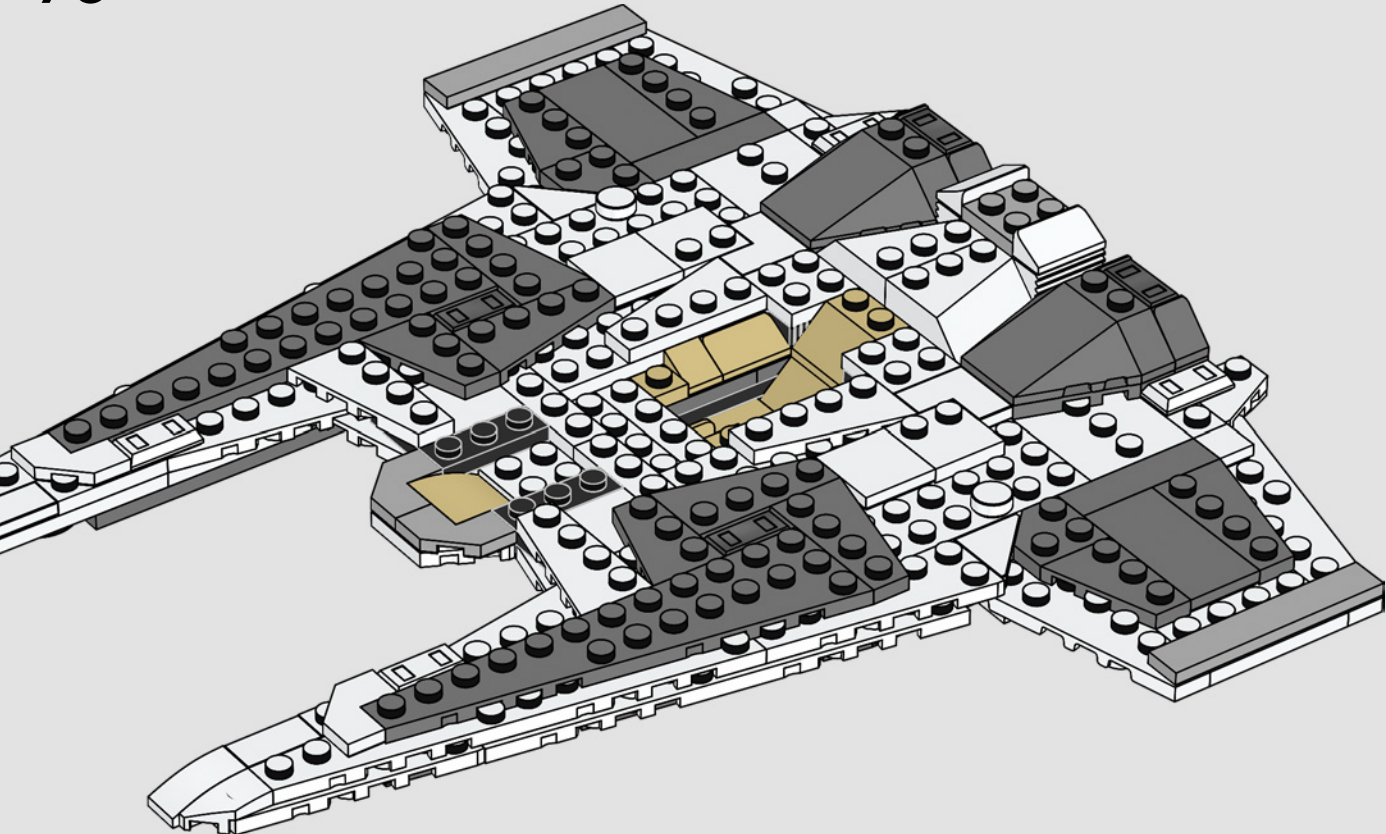

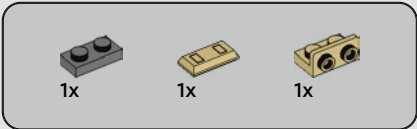

74

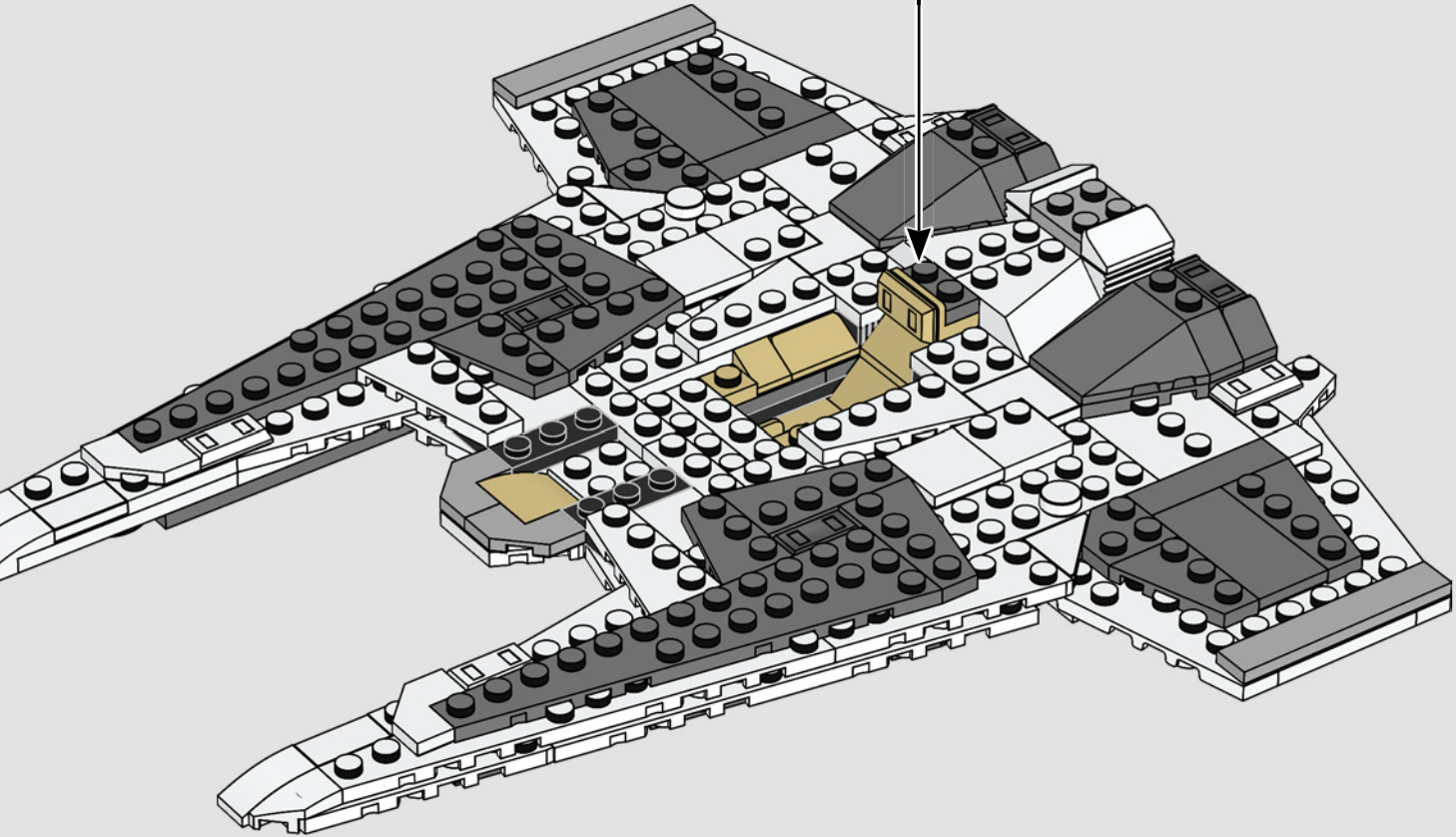
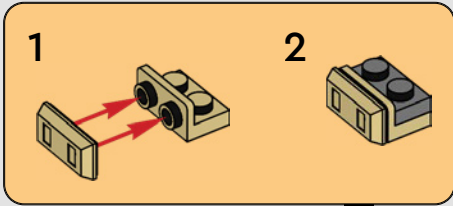

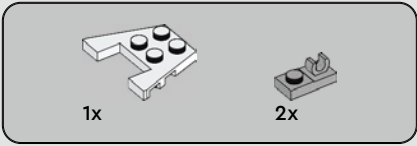

75

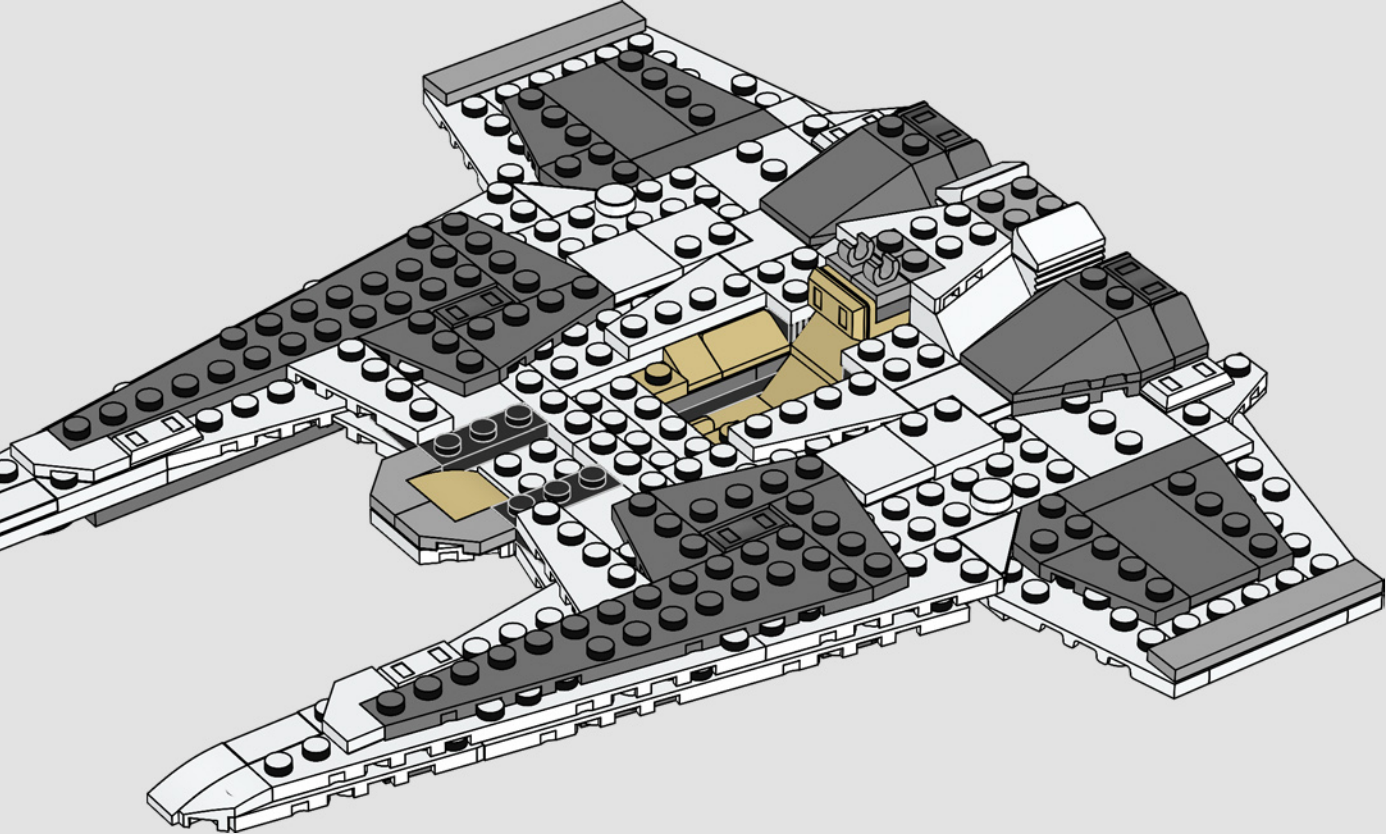





2x



2x



2x

76

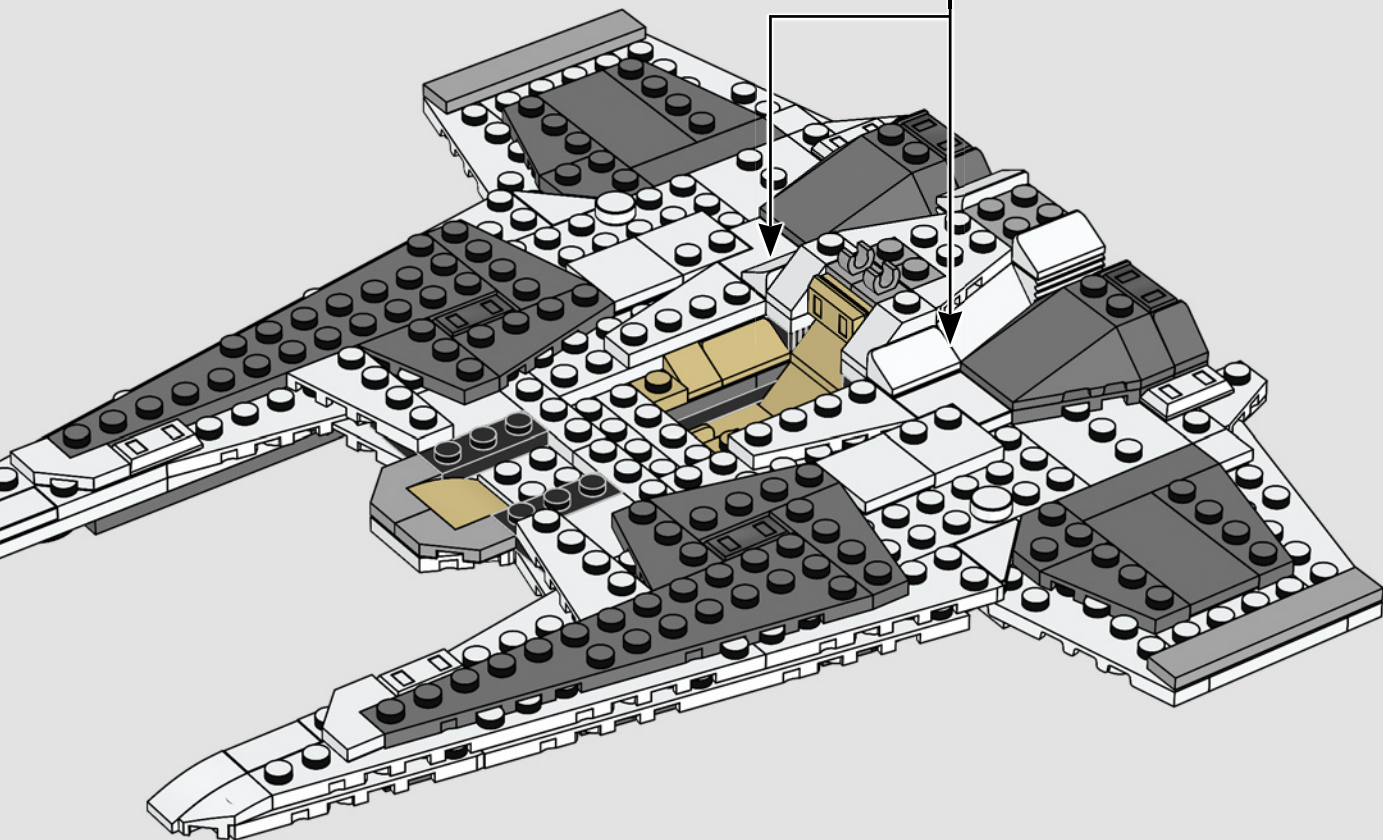

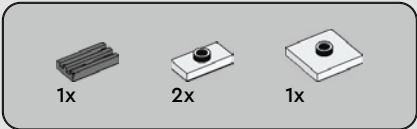

77

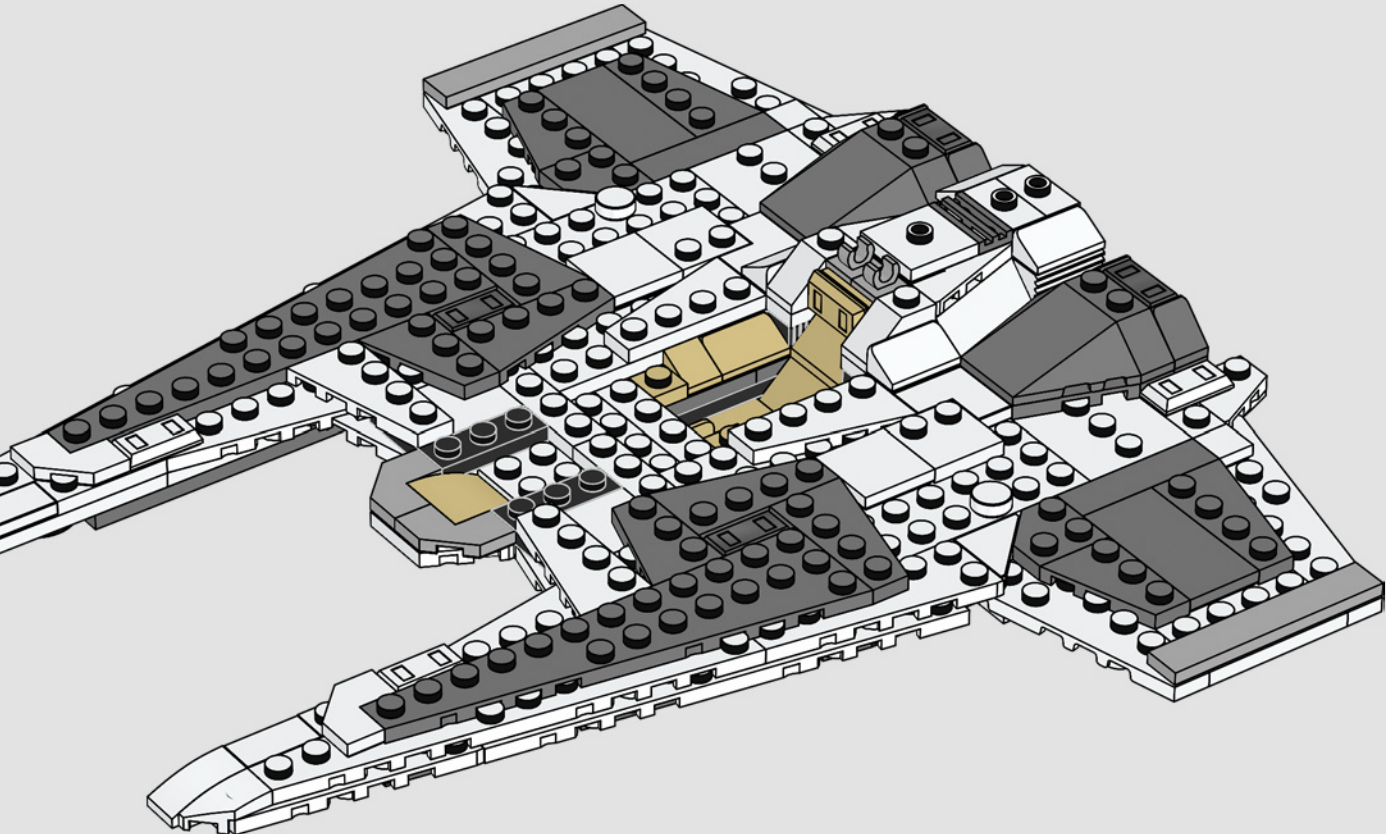



1x



1x

# 78

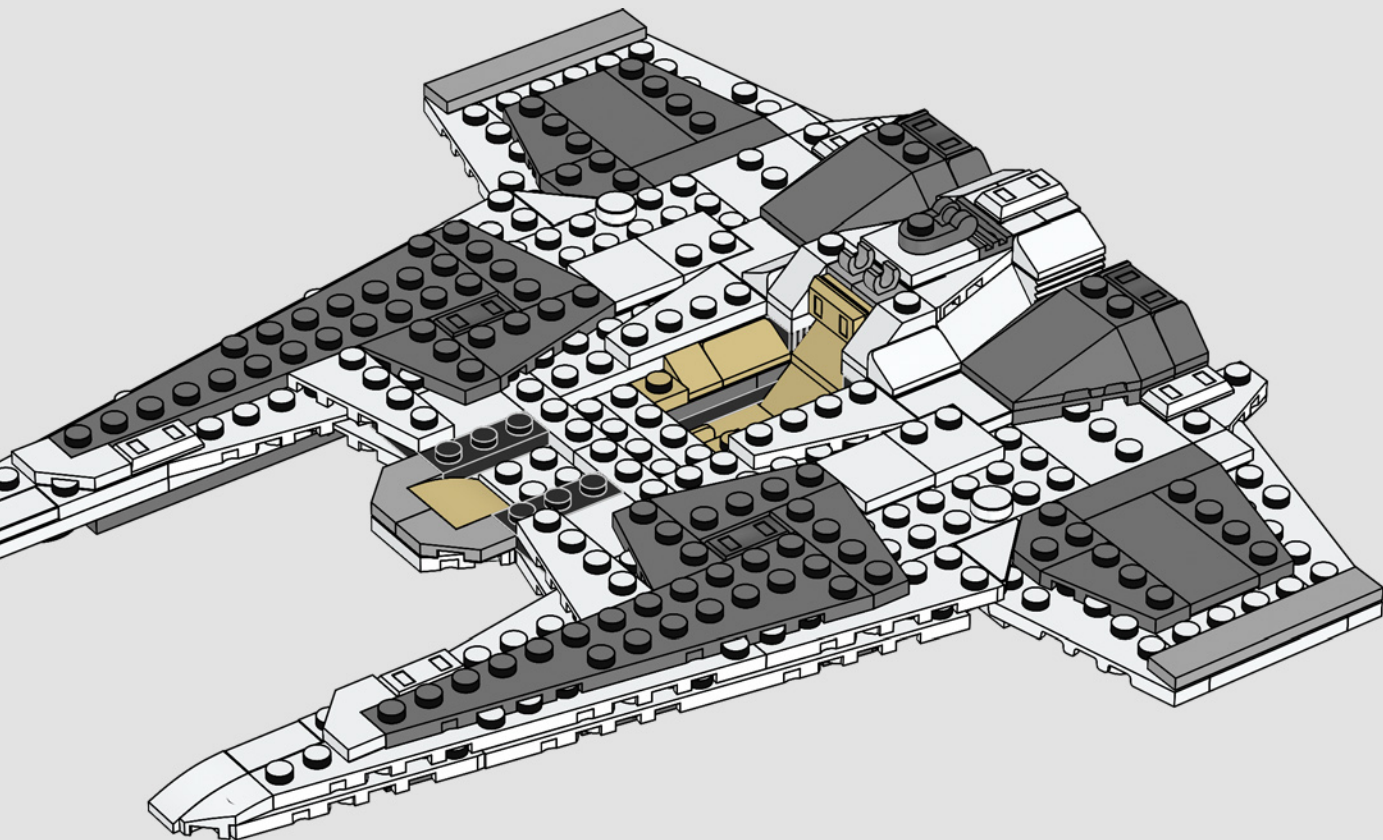

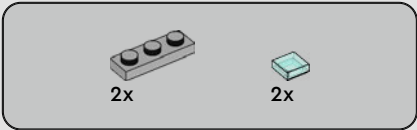

79

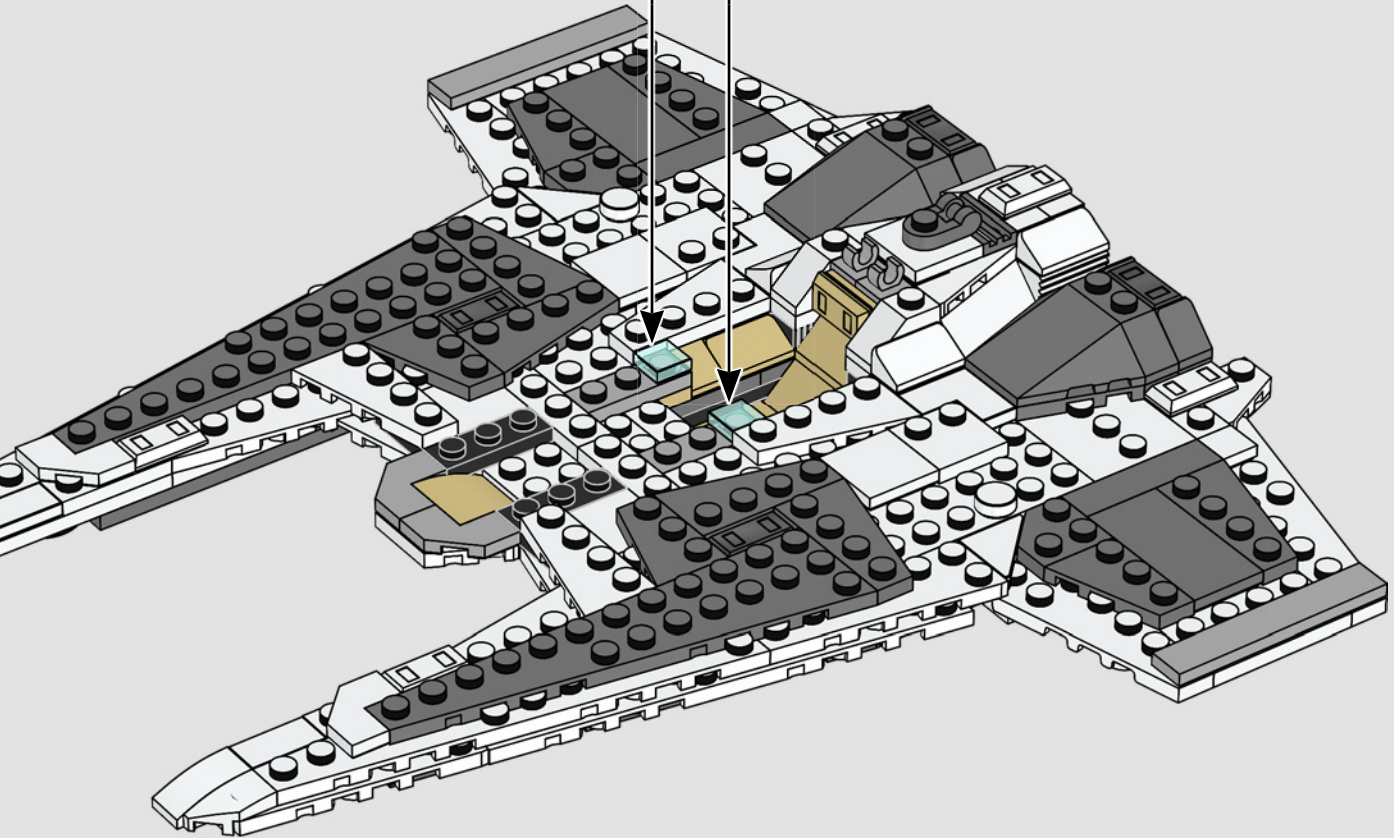
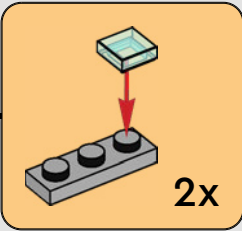



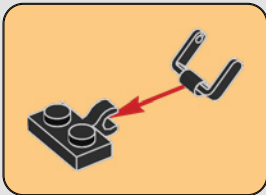
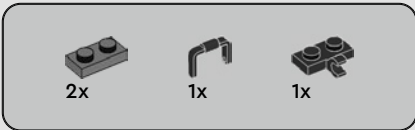

80

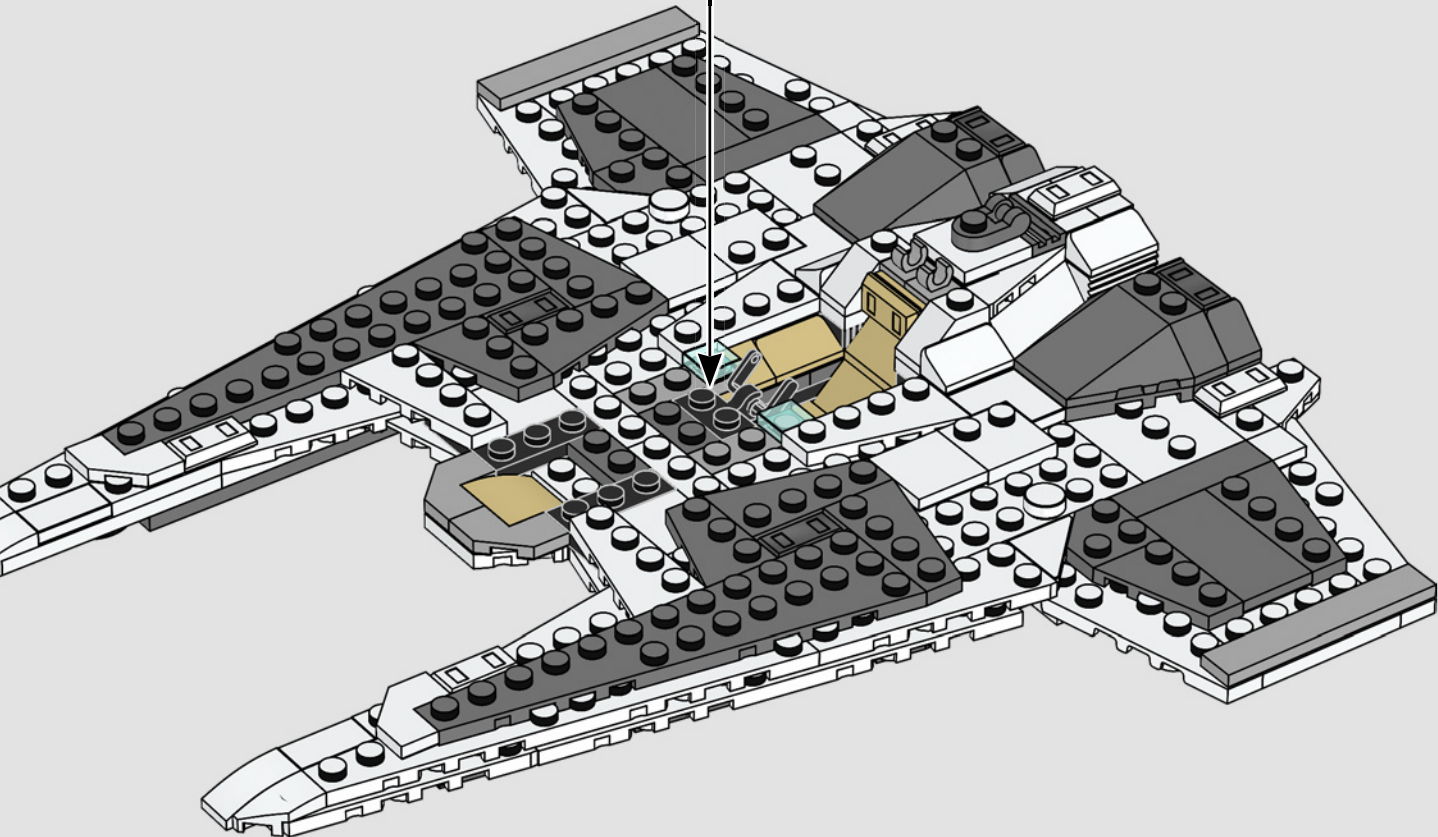

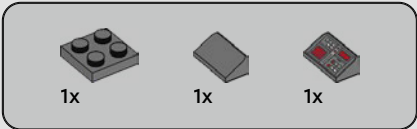

81

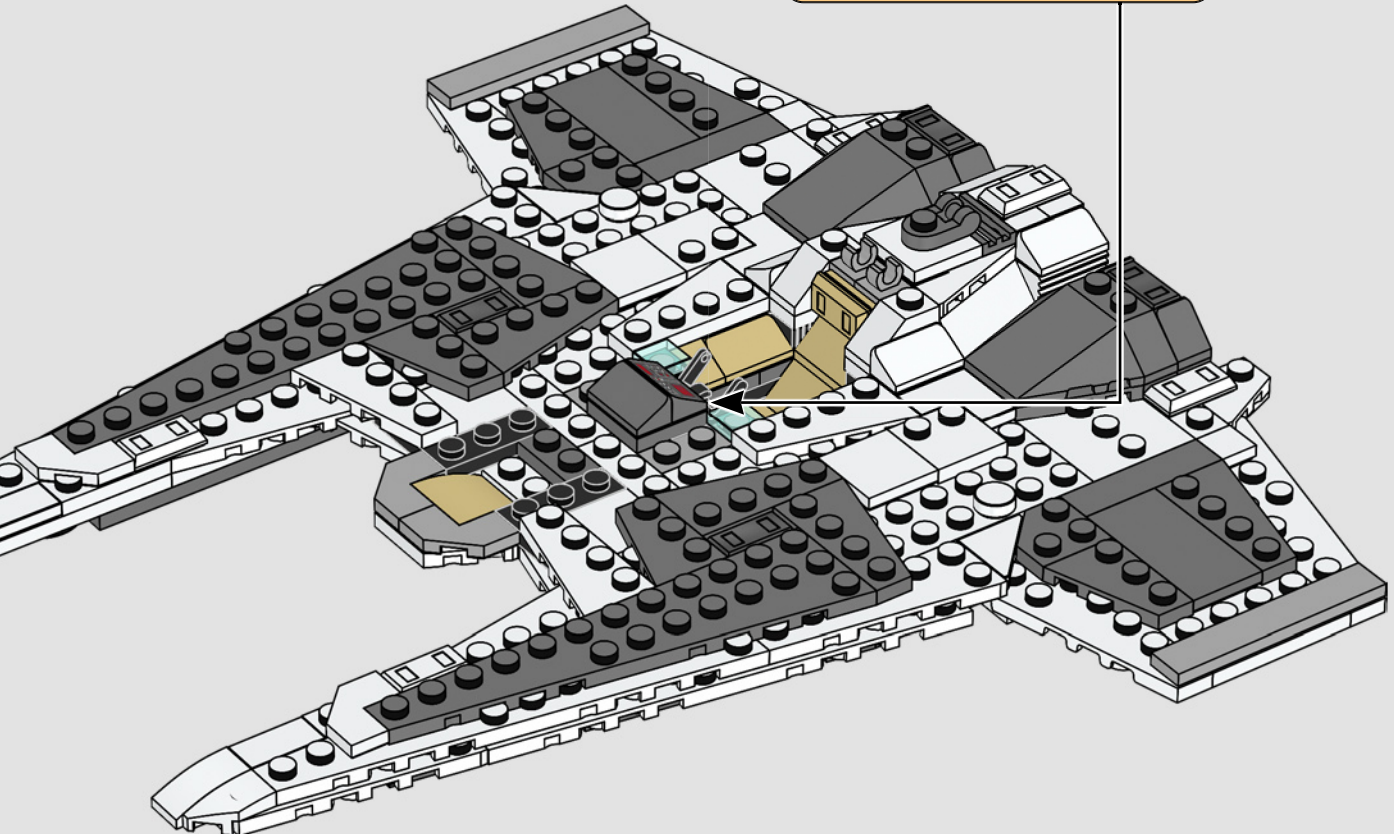
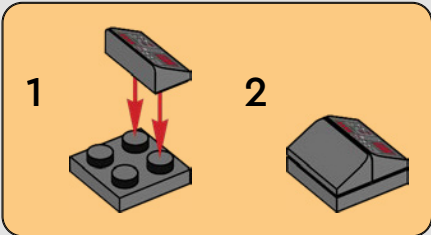

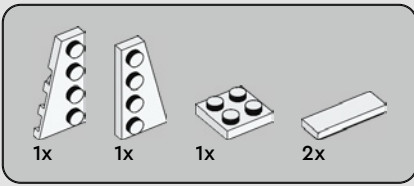

82

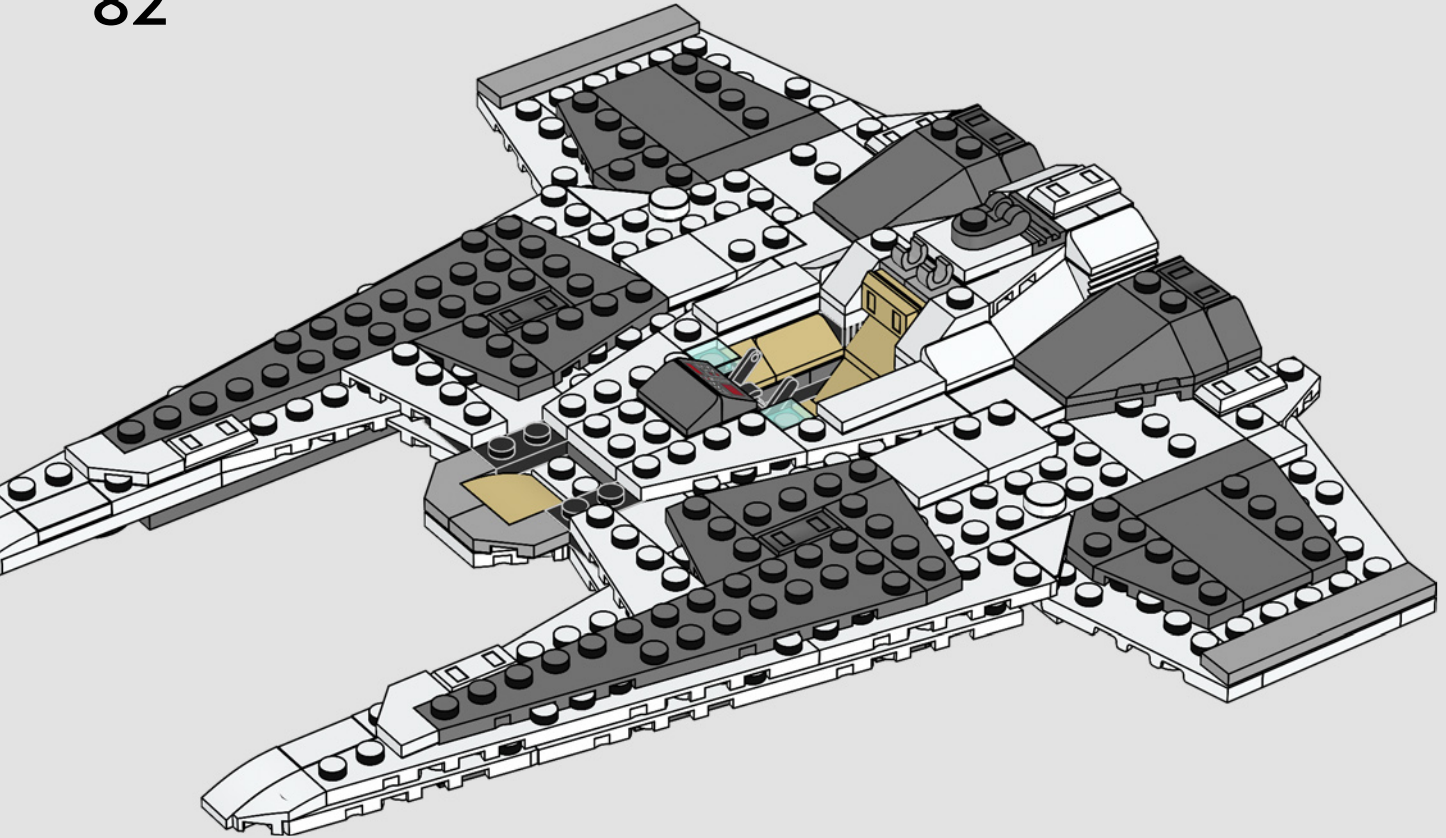

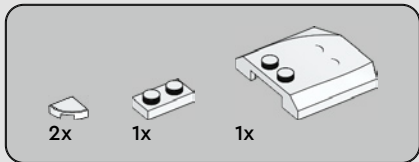

83

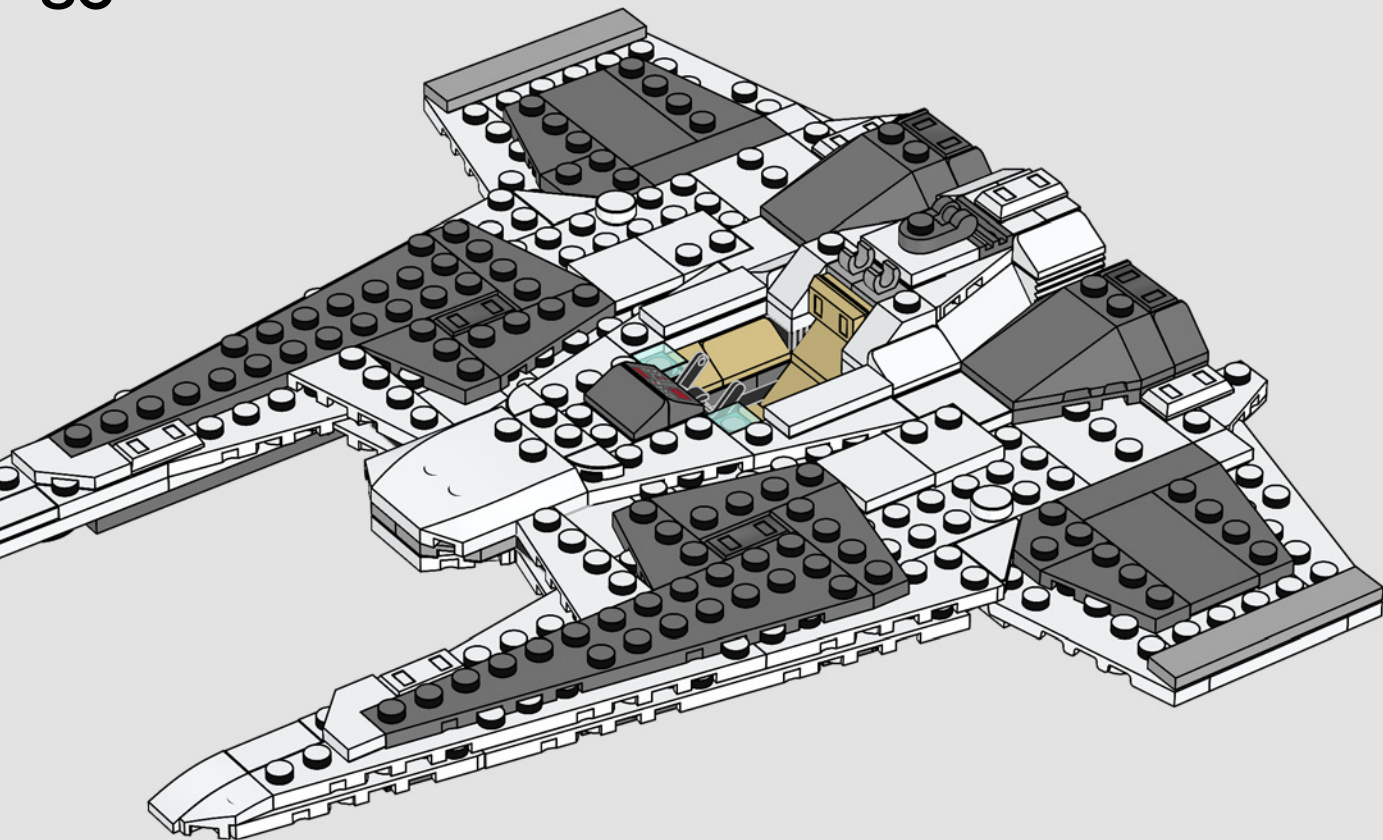



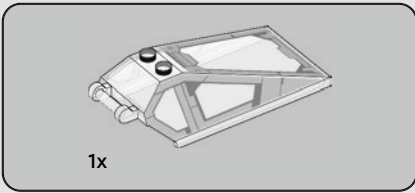

84

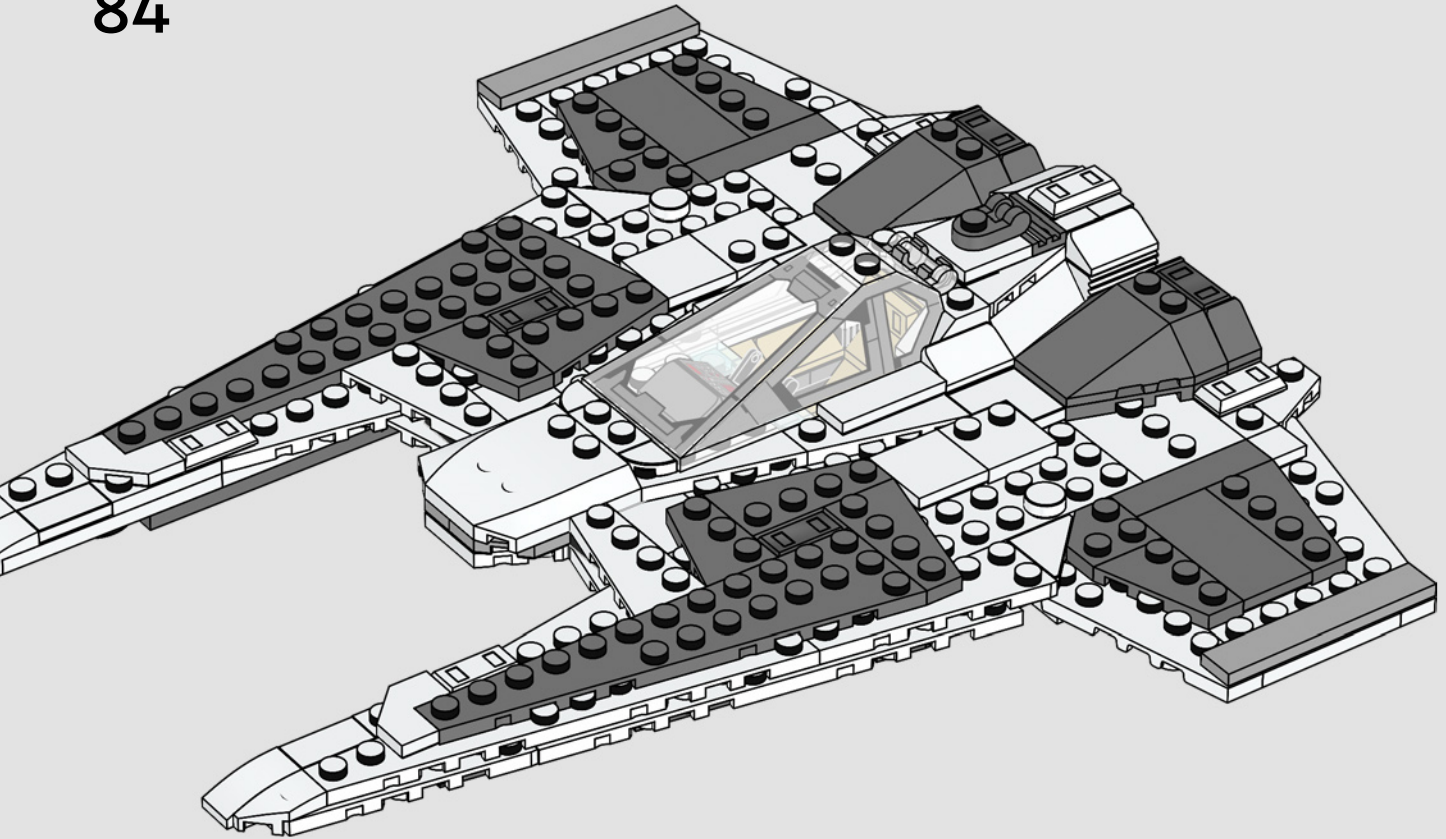



85

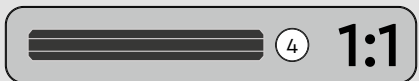
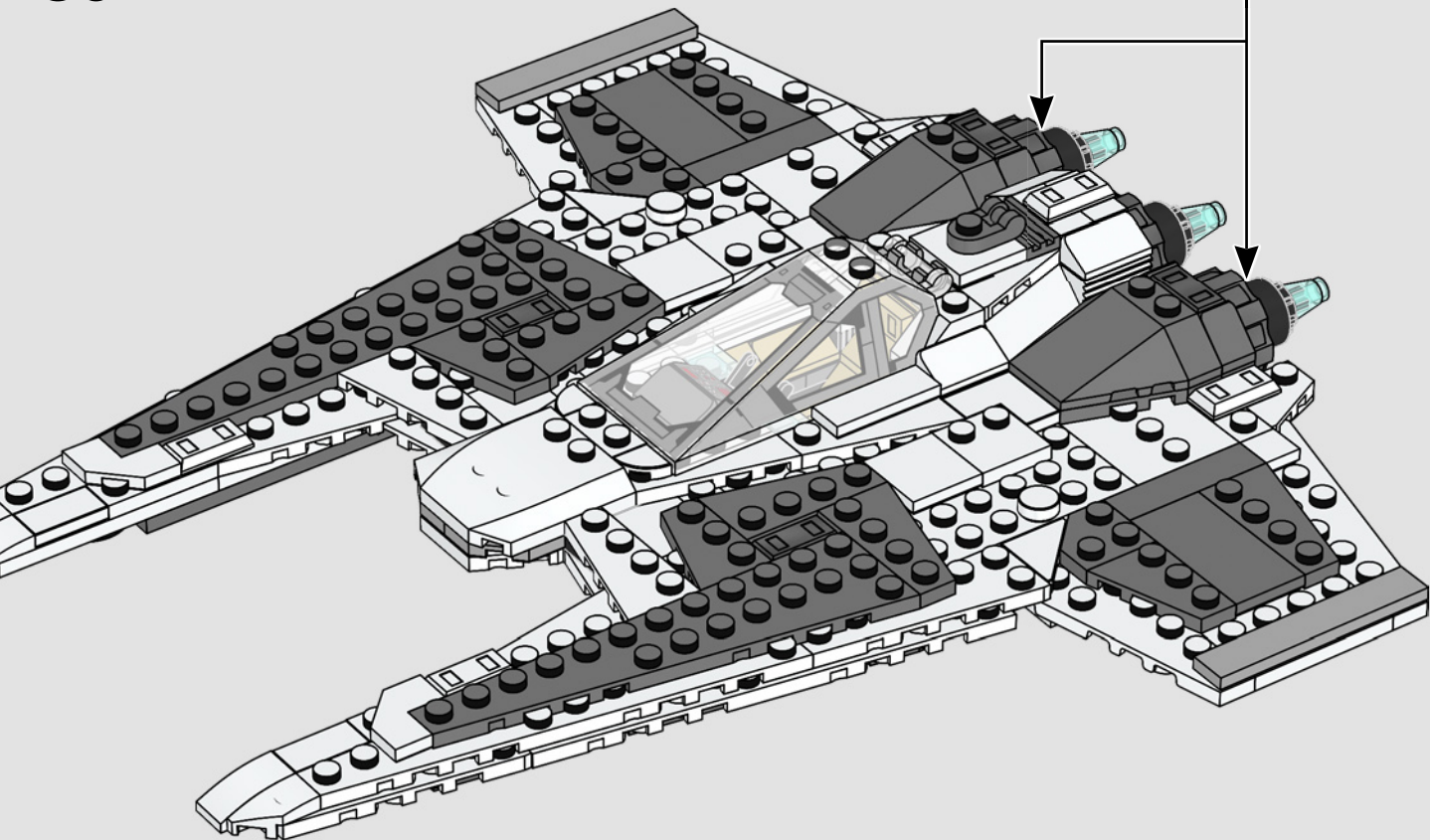
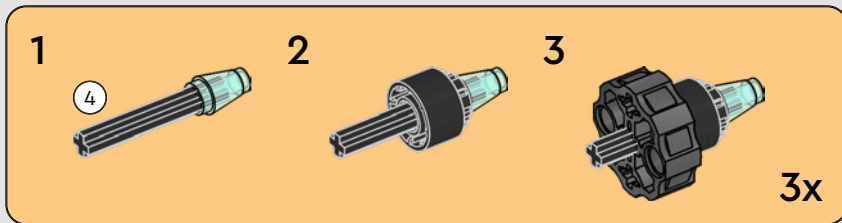

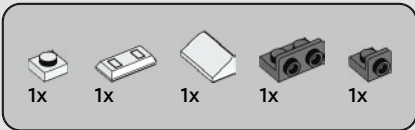

86

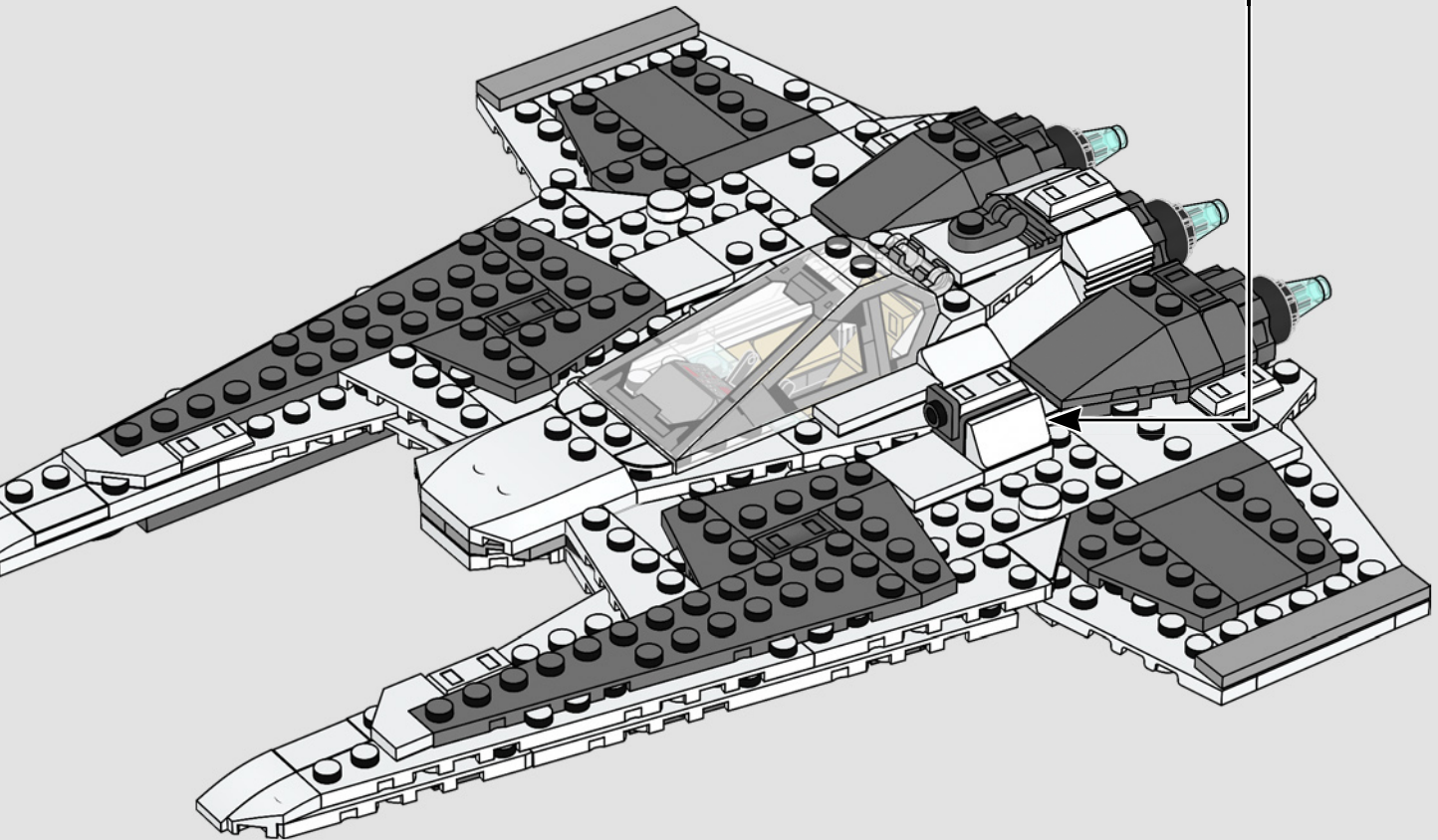
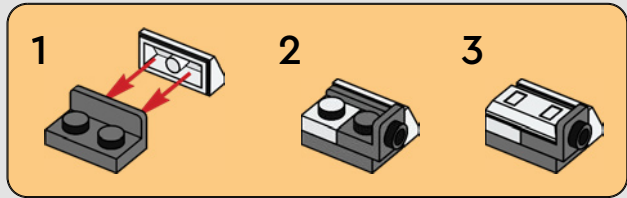



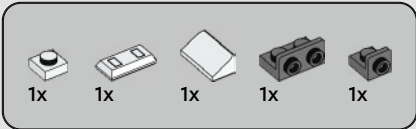

87

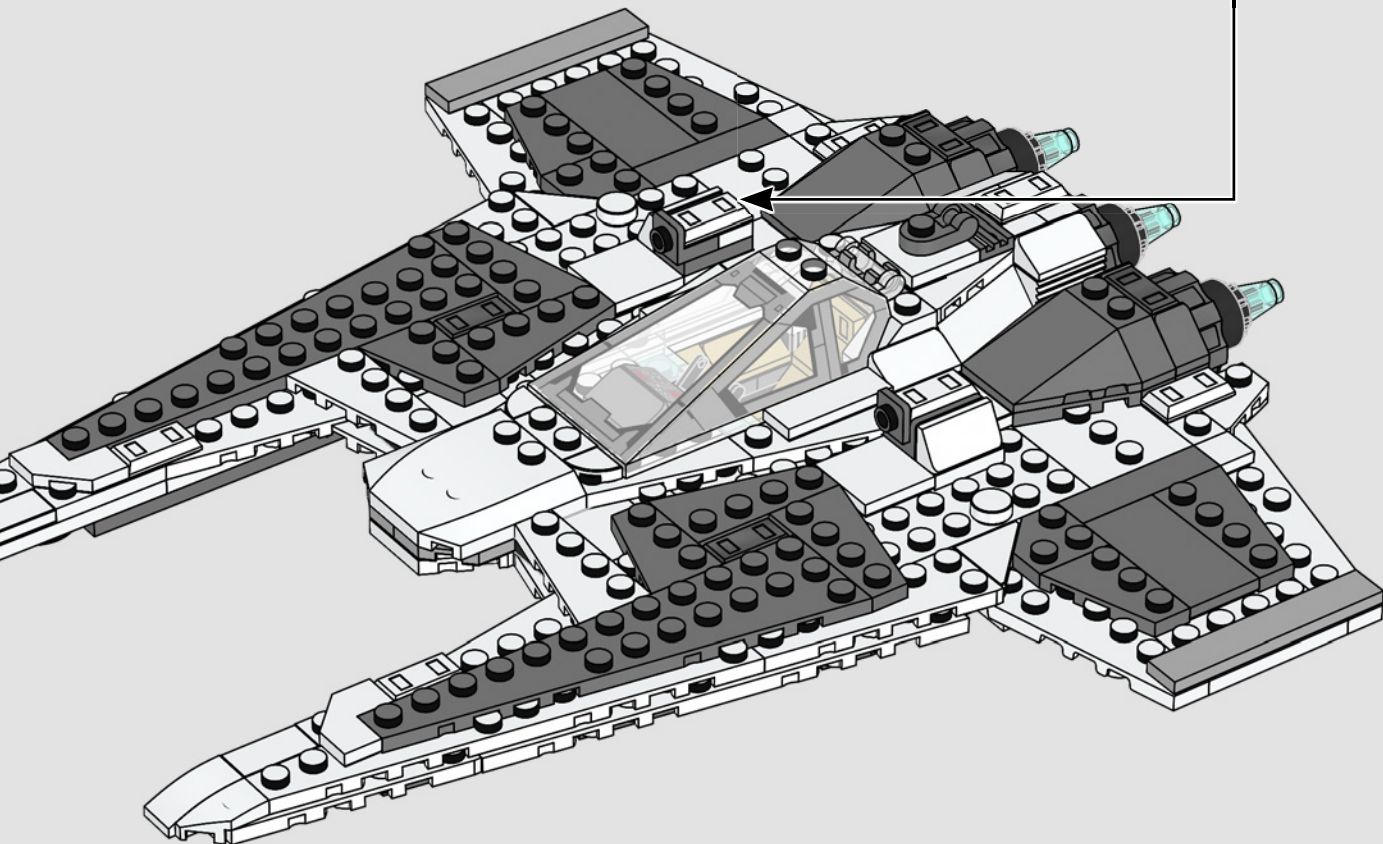
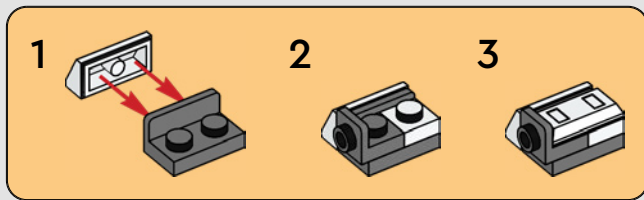



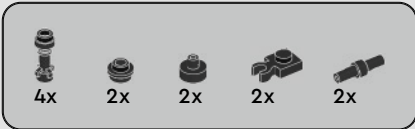

88

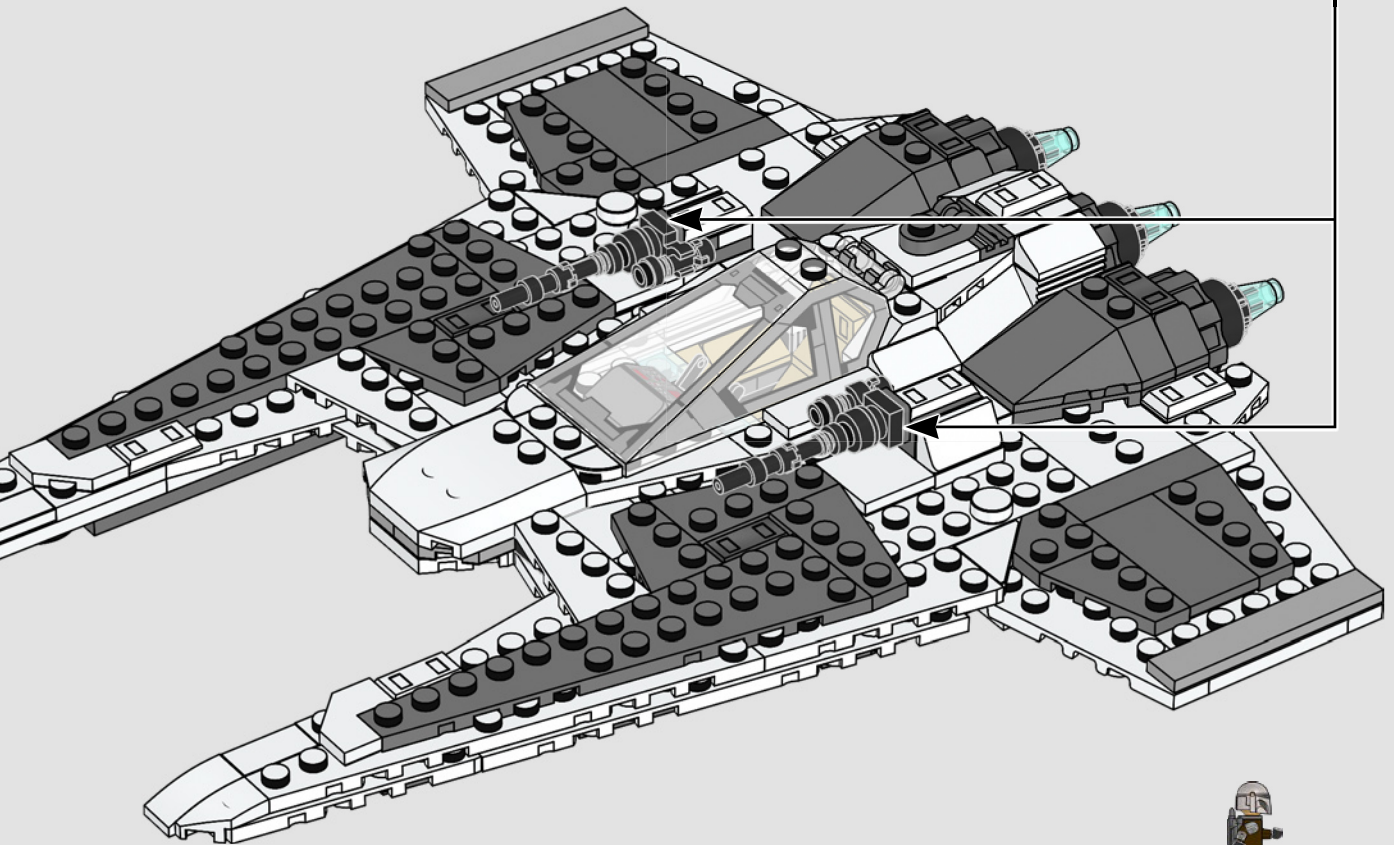
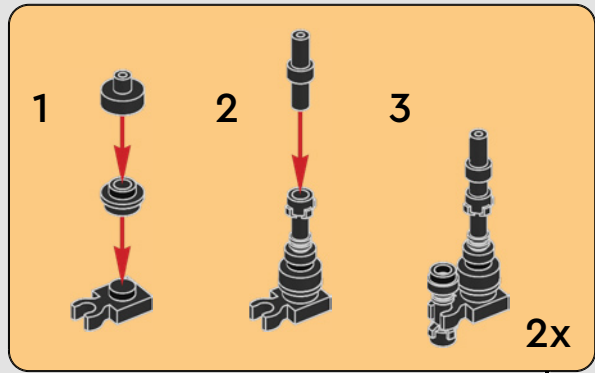

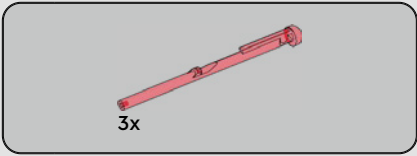

89

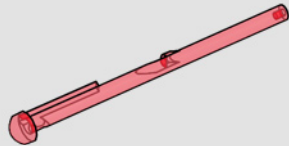
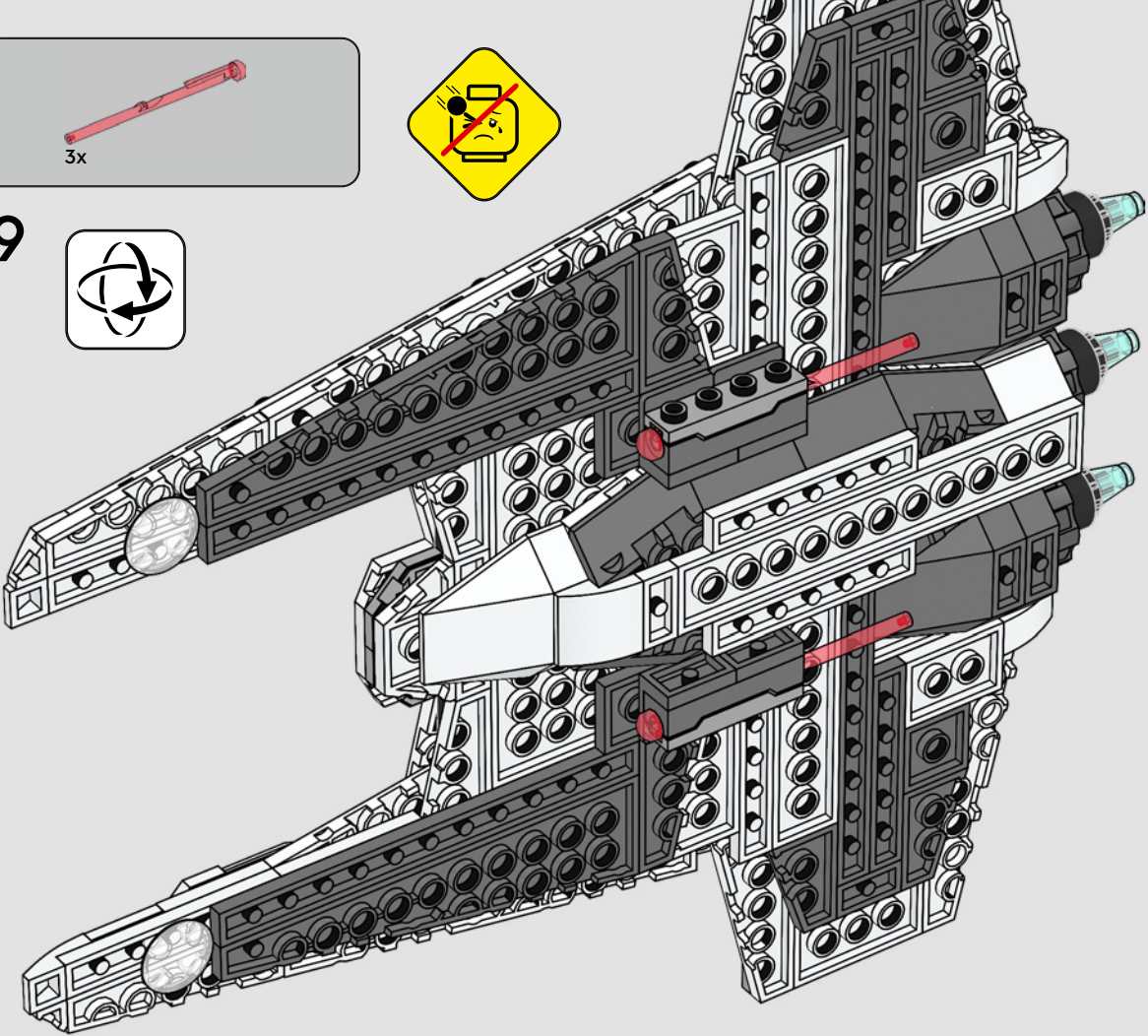

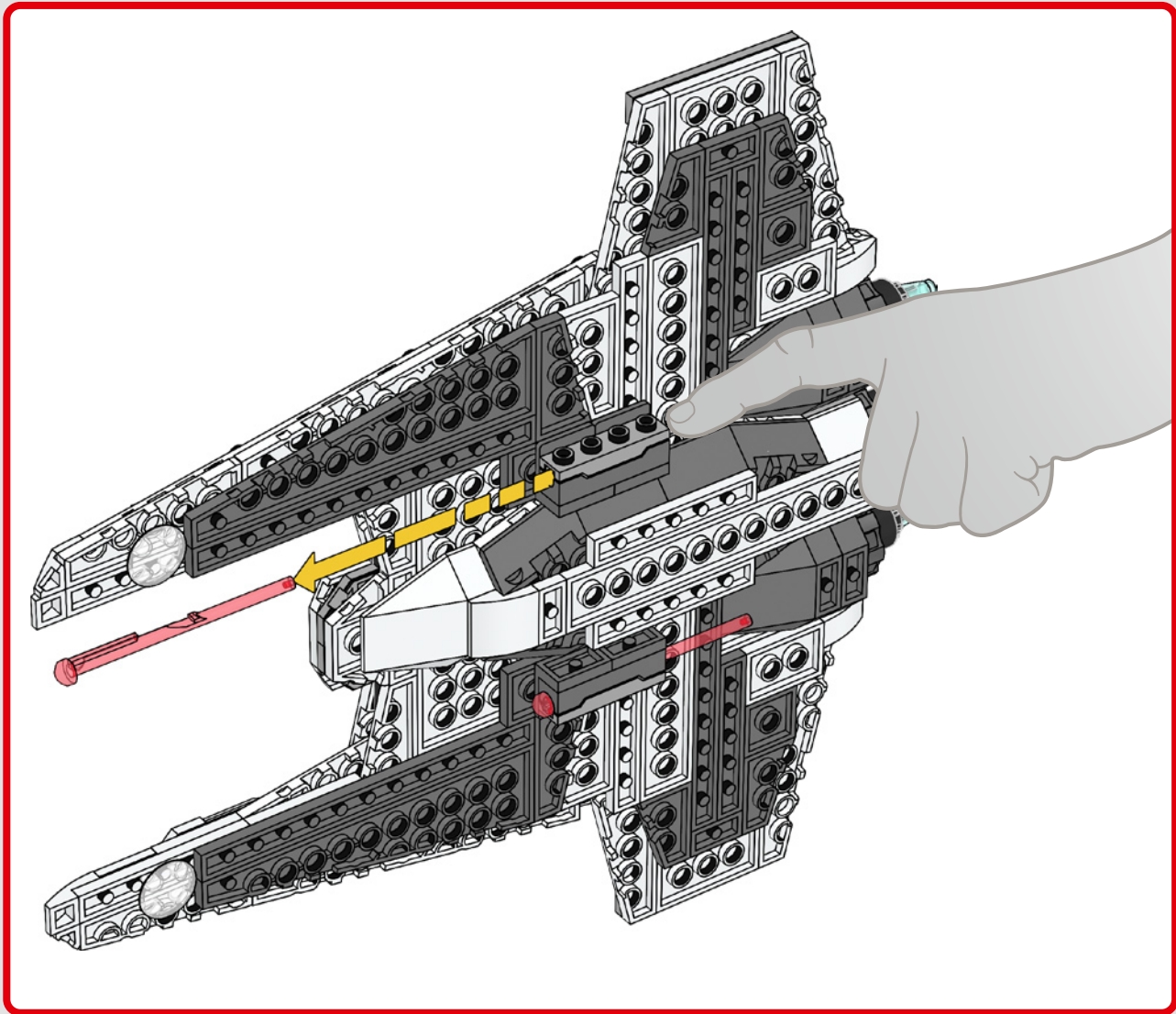

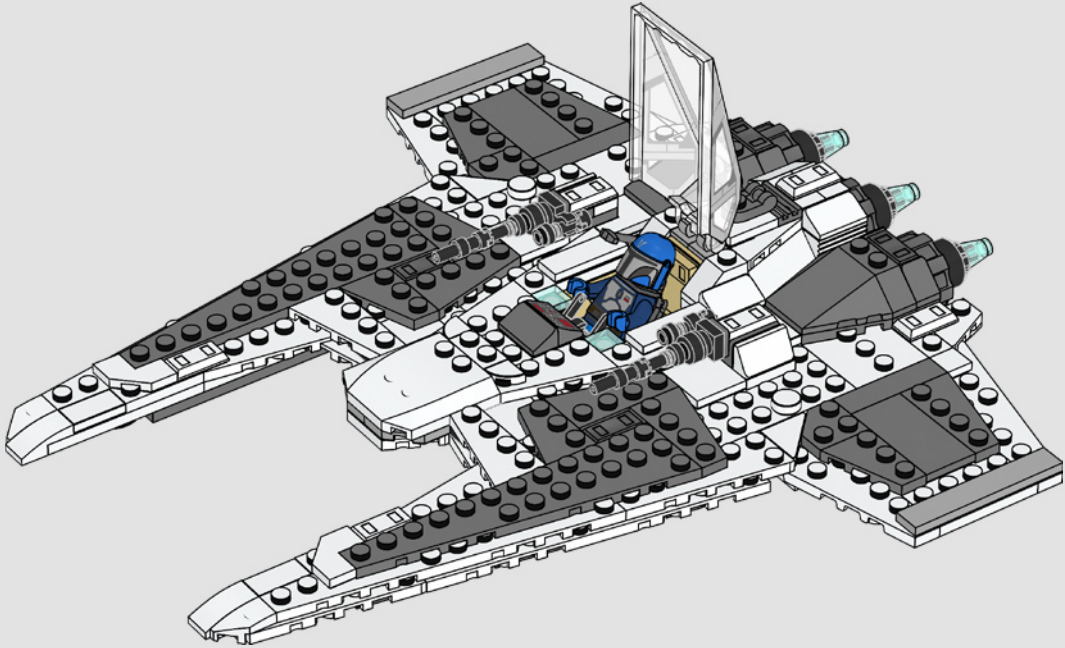



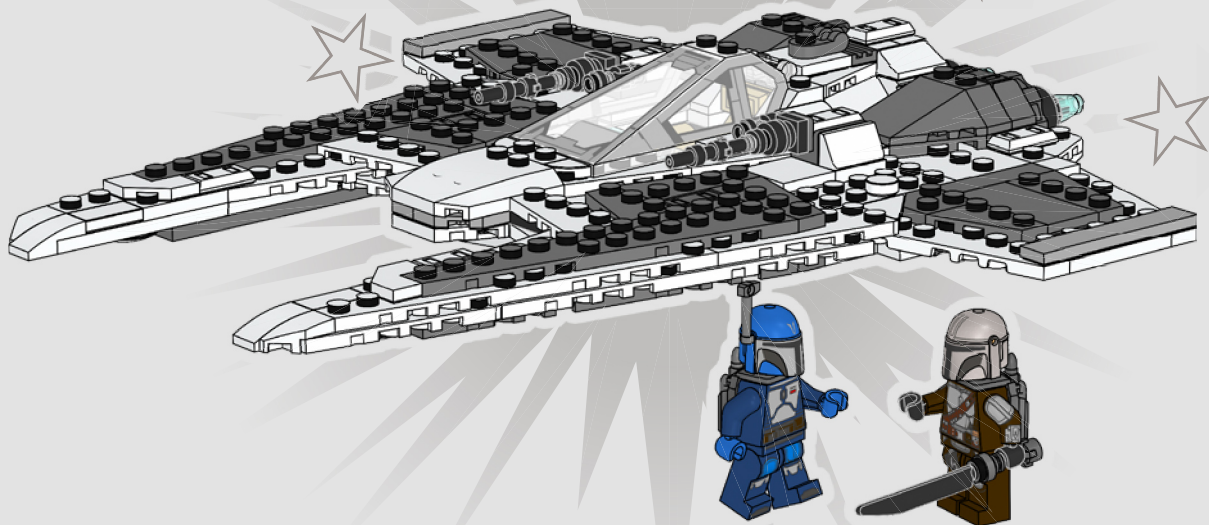



# STAR WARS

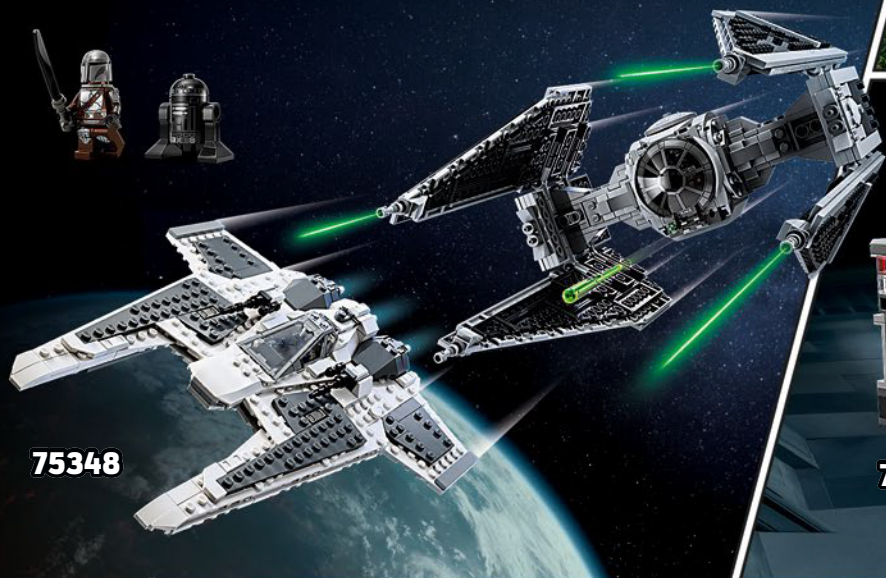

75348



75321

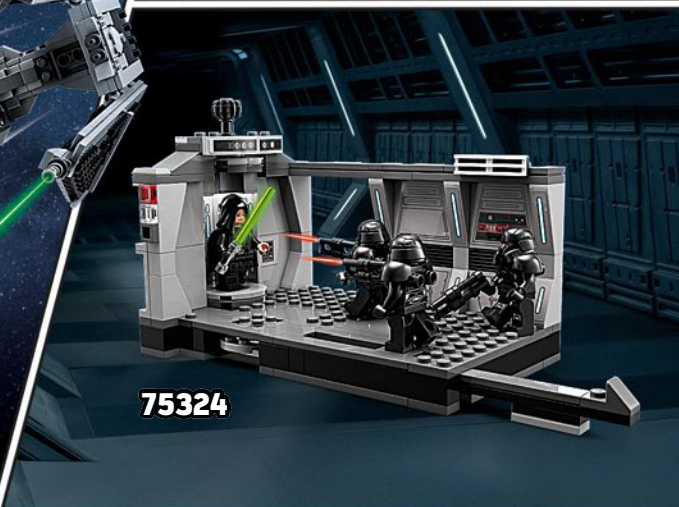

75324



75346



75325

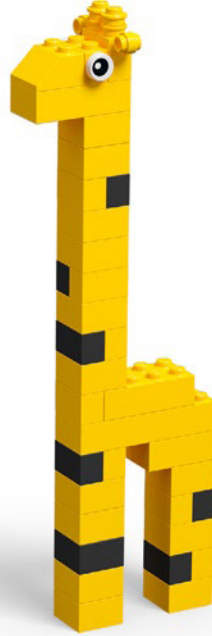
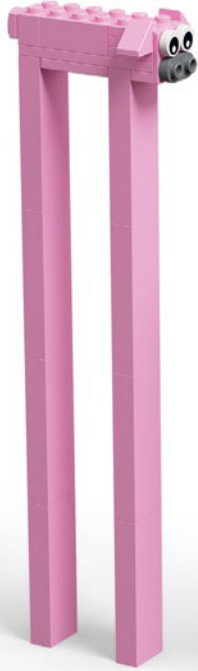

Rebuild  
the  
world™



YOU COULD **WIN**

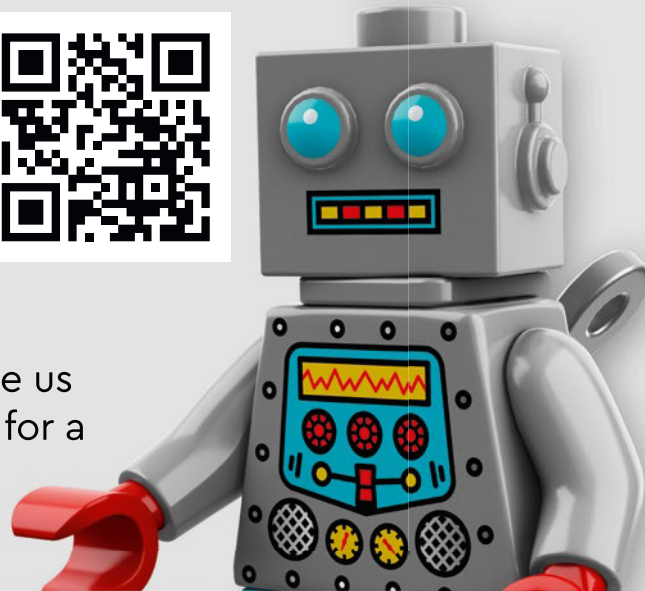

Scan this QR code or go to **LEGO.COM/PRODUCTFEEDBACK** and give us your short feedback about this LEGO® set for a chance to win a cool LEGO prize.

Terms and Conditions apply\*

**EN: YOU COULD WIN.** Terms and Conditions apply\* **DE: Du könntest GEWINNEN.** Es gelten die Teilnahmebedingungen\* **FR: Tu pourrais GAGNER.** Des conditions s'appliquent\* **IT: Potresti VINCERE tu.** Termini e condizioni sono applicabili\* **ES: Puedes GANAR.** Aplican términos y condiciones\* **PT: Poderá GANHAR.** Aplicam-se termos e condições\* **ZH: 轻松获奖. 条款和条件适用\*** **PL: Szansa na WYGRANĄ.** Obowiązują warunki korzystania\* **CS: Máte šanci VYHRÁT.** Platí všeobecné smluvní podmínky\* **SK: Máte šancu VYHRAŤ.** Platia všeobecné zmluvné podmienky\* **HU: TE IS NYERHETSZ.** Felhasználási feltételek érvényesek\* **RO: Ai putea CÂȘTIGA.** Se aplică termeni și condiții\* **BG: Можете да СПЕЧЕЛИТЕ.** Има определени правила и условия\* **LV: Tu vari LAIMĒT.** Ir spēkā noteikumi un nosacījumi.\* **ET: Sul on võimalus VÕITA.** Kehtivad tingimused\* **LT: Jūs galite LAIMĖTI.** Taikomos sąlygos\*

\*[LEGO.com/productfeedback-terms](https://www.lego.com/productfeedback-terms)

LEGO and the LEGO logo are trademarks of the LEGO Group. ©2023 The LEGO Group.  
© & ™ Lucasfilm Ltd.