

Elford - Coffee Table

Assembly Instructions - Please keep for future reference

247/7624

249/7329

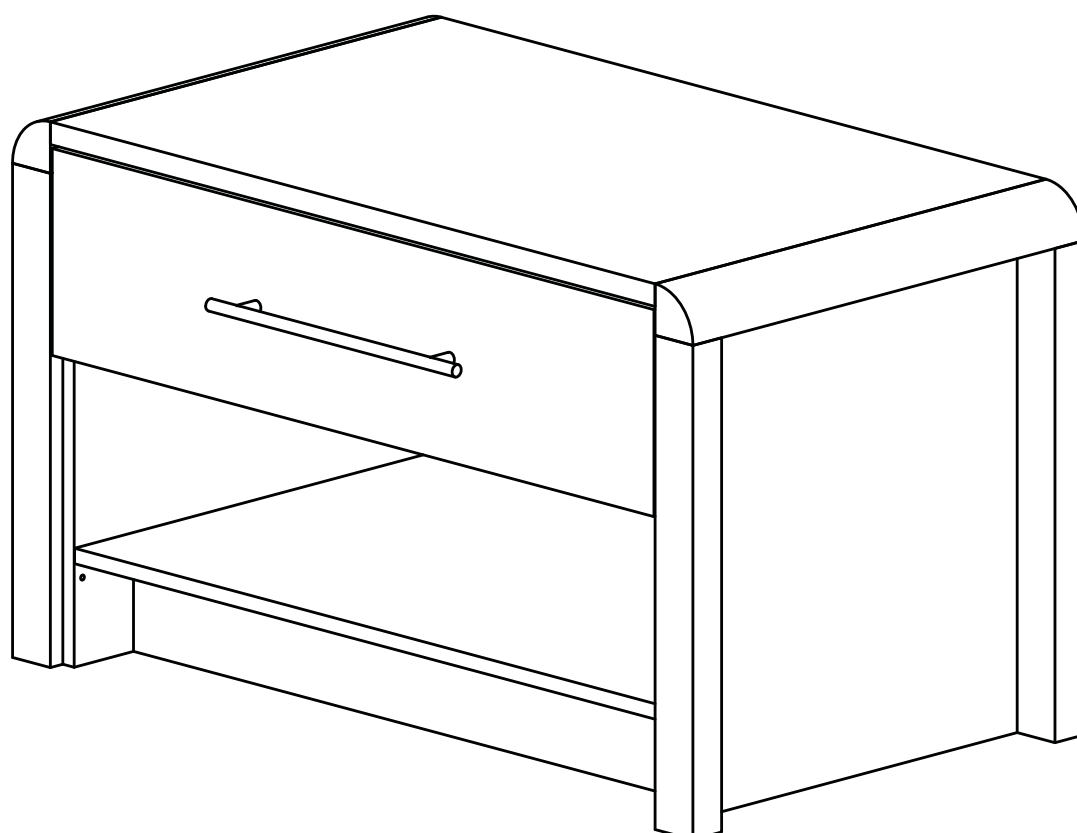

Dimensions

Width - 90cm

Depth - 51.7cm

Height - 53cm

Important – Please read these instructions fully before starting assembly

If you need help or have damaged or missing parts, call the **Customer Helpline:**

Argos = 0345 6403030



Safety and Care Advice

Important – Please read these instructions fully before starting assembly

- Check you have all the components and tools listed on pages 2 and 3.
- Remove all fittings from the plastic bags and separate them into their groups.
- Keep children and animals away from the work area, small parts could choke if swallowed.
- Make sure you have enough space to layout the parts before starting.
- Do not stand or put weight on the product, this could cause damage.
- Assemble the item as close to its final position (in the same room) as possible.

- Assemble on a soft level surface to avoid damaging the unit or your floor.
- Parts of the assembly will be easier with 2 people.
- Do not use extended drawers to aid standing. Do not stand on extended drawers.
- Do not over load drawers, the maximum load per drawer should not exceed 3kg
- To prevent bowing of shelves do not over load, and always distribute weight evenly.
- If a residual aroma is experienced with your new furniture after the packaging is removed simply ensure the room is well ventilated and this will assist a speedy removal

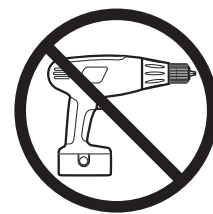

- We do not recommend the use of power drill/ drivers for inserting screws, as this

could damage the unit. Only use hand screwdrivers.

- Dispose of all packaging carefully and responsibly.
- Please retain the product label on the back of the unit, as this information will help support any queries.

Care and maintenance - Non compliance with this information may affect your guarantee

- Dust with a clean cloth or, if required a slightly damp cool cloth. Do not use household cleaners, abrasives or polishes as permanent damage may occur.
- Do not drag the furniture or lift it by its top.
- Avoid sharp objects, contact with water and direct heat on all surfaces

- Your furniture is finished to the required colour. Avoid exposure to strong sunlight as this can change the colour. Change in appearance may also occur if items are permanently left on a surface.
- Drawers should be secured or removed before moving.

- You should get assistance when moving or lifting your furniture. Furniture consisting of more than one unit should be disassembled before attempting to move it.
- This product should not be discarded with household waste. Take to your local authority waste disposal centre.

Handy Hints

- Assemble all parts and bolts loosely during assembly, only once the product is complete should you fully tighten the bolts.
- Regularly check and ensure that all bolts and fittings are tightened properly.

Note: if required the next page can be cut out and used as reference throughout the assembly. Keep this page with these instructions for future reference.

Components - Panels

If you have damaged or missing components, call the
Customer Helpline: Argos = 0345 6403030

Please check you have all the panels listed below

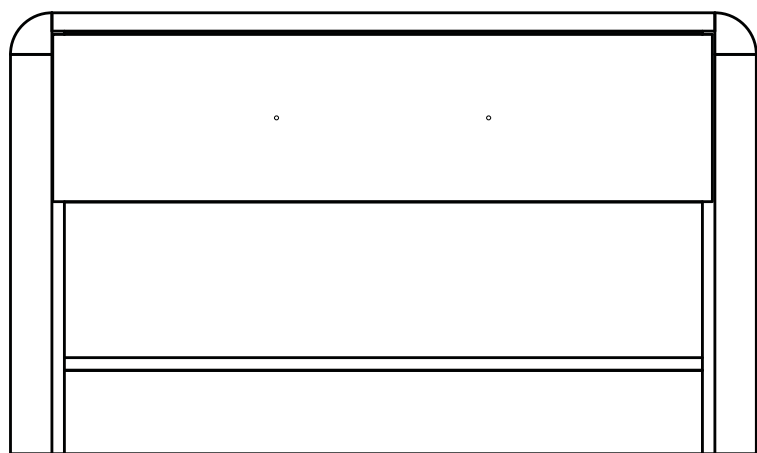



1 Coffee table (53 x 90 x 51.7cm)

Components - Fittings

Please check you have all the fittings listed below

Note: The quantities below are the correct amount to complete the assembly. In some cases more fittings may be supplied than are required.

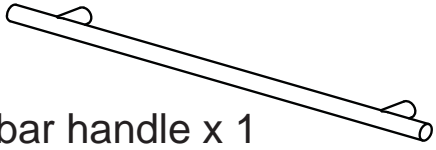
The following components are pre-fitted and are illustrated for reference only.

| | |
|---|--|
|  <p>Large bar handle x 1</p> |  <p>20mm Handle screw x 2</p> |
|---|--|

Tools required

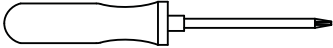
 Phillips screwdriver (medium)

Ruler - Use this ruler to help correctly identify the screws

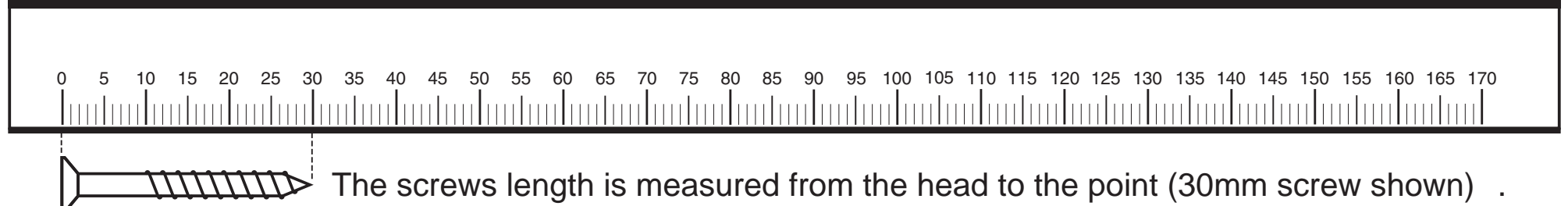

Assembly Instructions

Step 1

Remove and replace handles

a: Position the unit in the required position. The large bar handles are fitted to the inside the unit, using a Philips screwdriver unscrew the 20mm handle screws in each handle and remove both the 20mm handle screw and the large bar handles.

a:

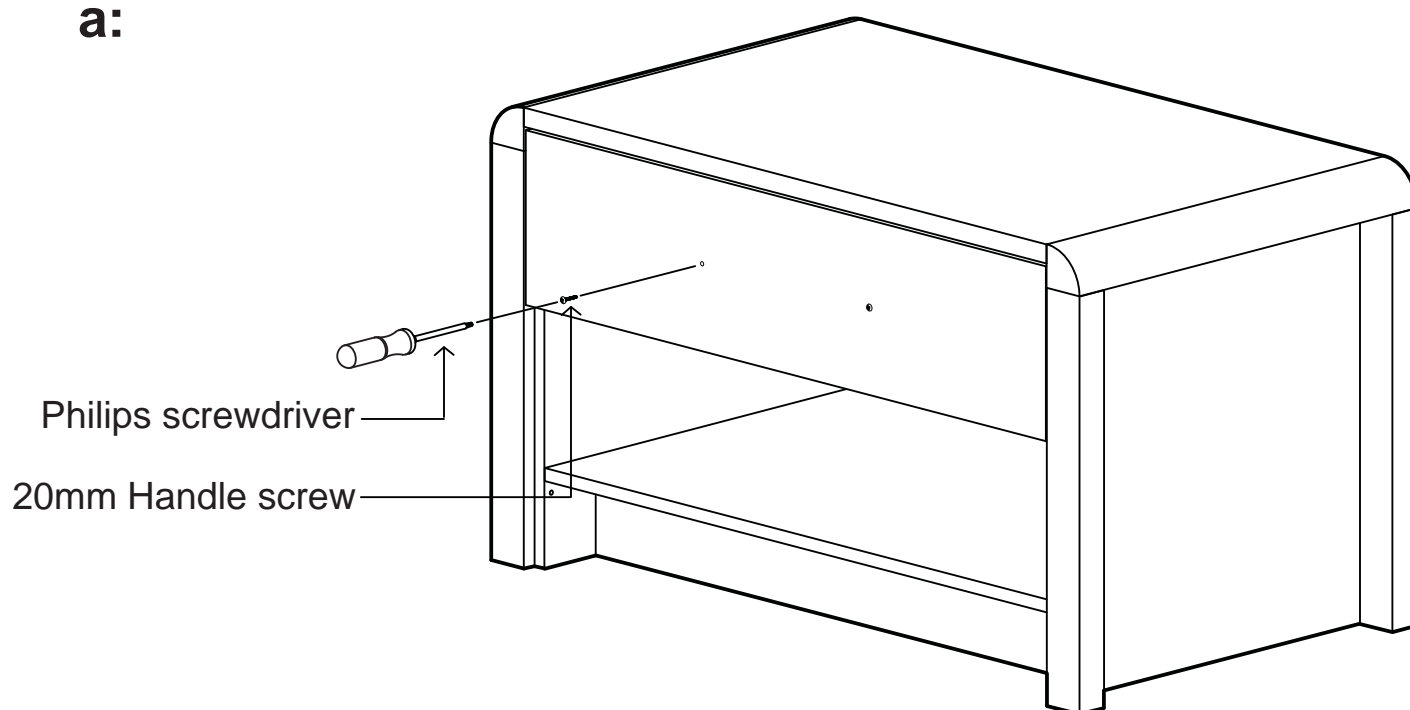

b: Replace the large bar handles on the front of the unit. Fix in position by screwing the 20mm handle screw into each handle from inside the unit using a Philips screwdriver.

Note: Only use the 20mm handle screw that the handles were pre-fitted with.

b:

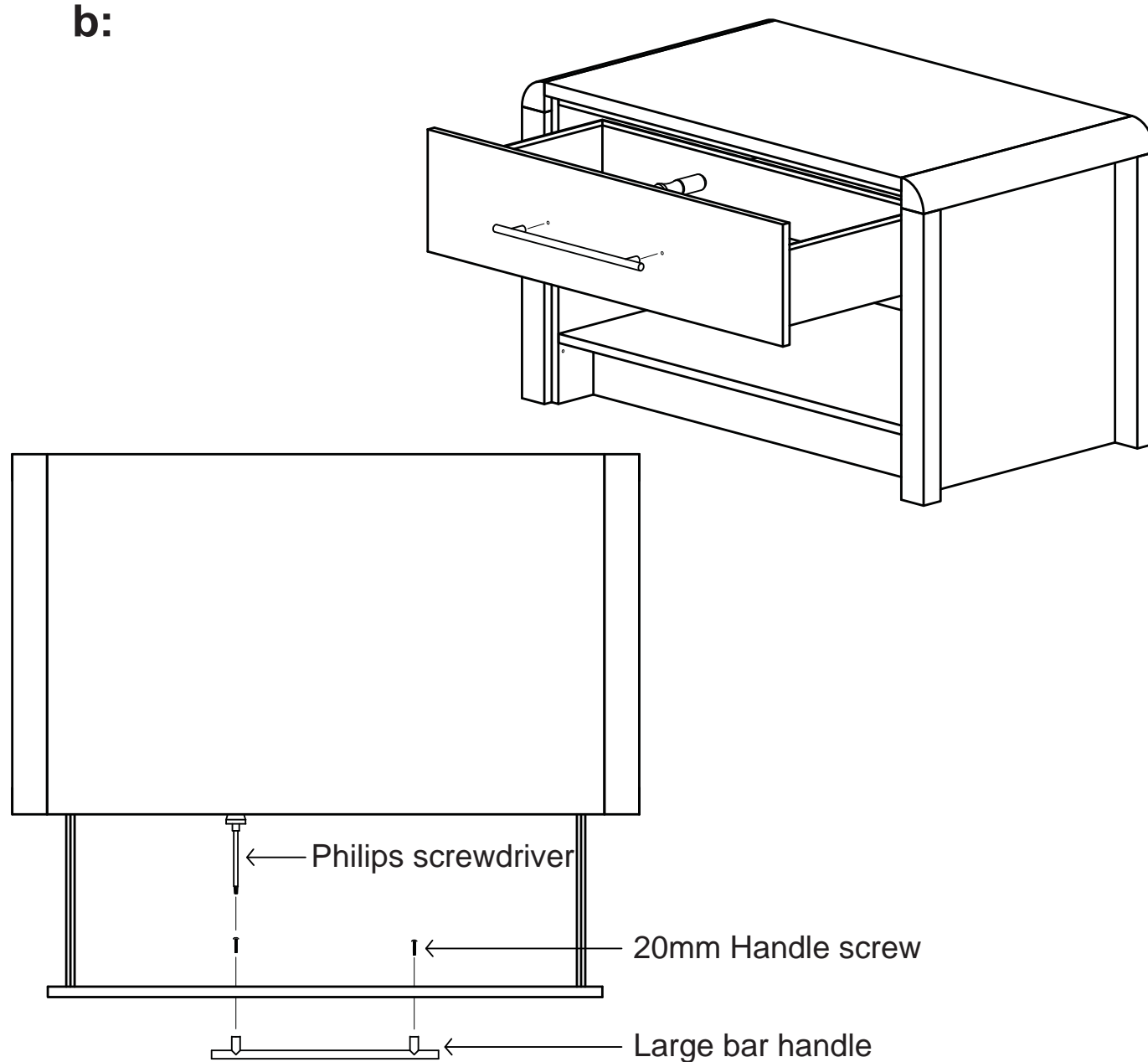

If you need help or have damaged or missing parts, call the **Customer Helpline:**
Argos = 0345 6403030