



# Disney

43215



1



[LEGO.com/sustainable-packaging](https://LEGO.com/sustainable-packaging)



# BUILDER



Apple and the Apple logo are trademarks of Apple Inc., registered in the U.S. and other countries and regions. App Store is a service mark of Apple Inc. Google Play and the Google Play logo are trademarks of Google LLC. Tencent and the Tencent logo are trademarks of Tencent Inc.

Q [LEGO.com/devicecheck](https://www.lego.com/devicecheck)

**EN** Ask parents' permission before going online | **DE** Eltern um Erlaubnis bitten, bevor du online gehst | **FR** Demande l'autorisation d'un parent avant d'aller en ligne | **IT** Chiedi il permesso ai tuoi genitori prima di andare online | **ES** Pídeles permiso a tus papás antes de conectarte a Internet | **PT** Peça autorização aos pais antes de acederes online | **ZH** 上网前应先征得父母的同意 | **PL** Poproś rodziców o zgodę, zanim wejdiesz do Internetu | **CS** Než půjdeš na internet, požádej rodiče o svolení | **SK** Skôr než pôjdeš na internet, vypýtaj si povolenie od rodičov | **HU** Kérj szülői engedélyt, mielőtt online csatlakoznál! | **RO** Cere permisiunea părinților înainte de a te conecta online | **BG** Поискайте разрешение от родител, преди да влезете онлайн | **LV** Pirms došanās tiešsaistē palūdz atļauju vecākiem | **ET** Enne Interneti kasutamist küsi vanematelt luba | **LT** Prieš prisijungdami prie interneto, atsklauskite tėvų

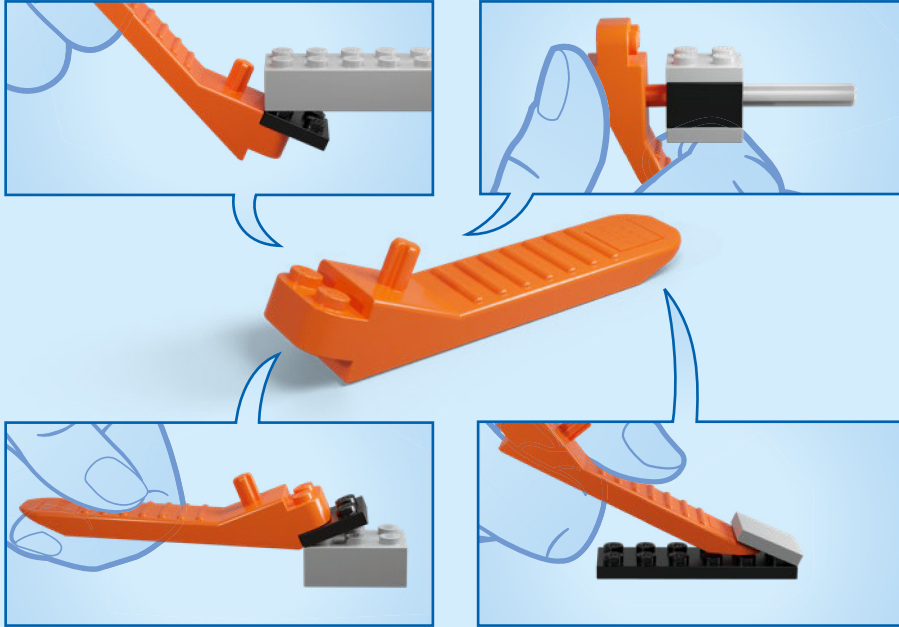

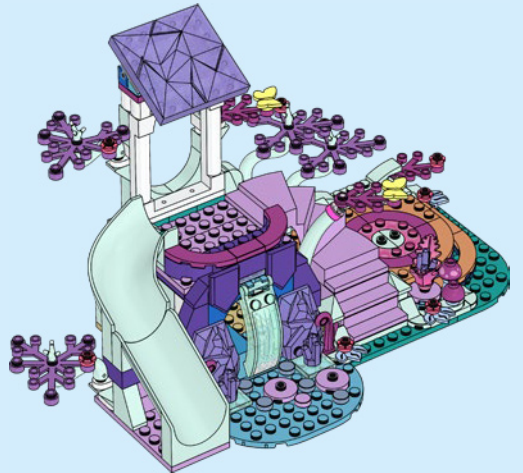
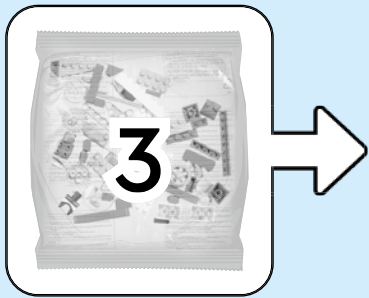
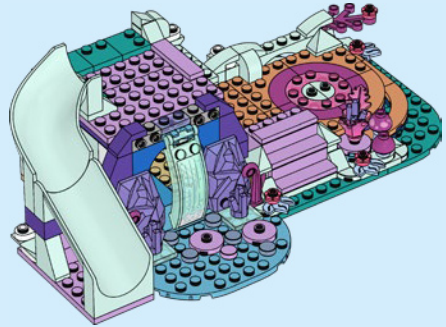
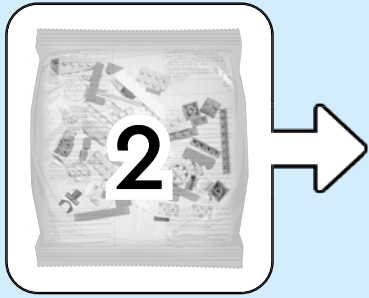
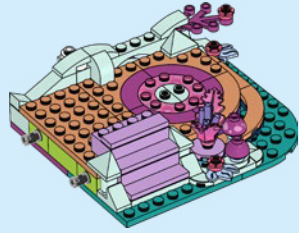
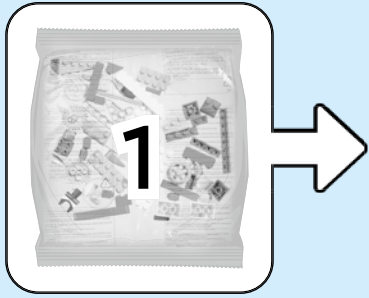

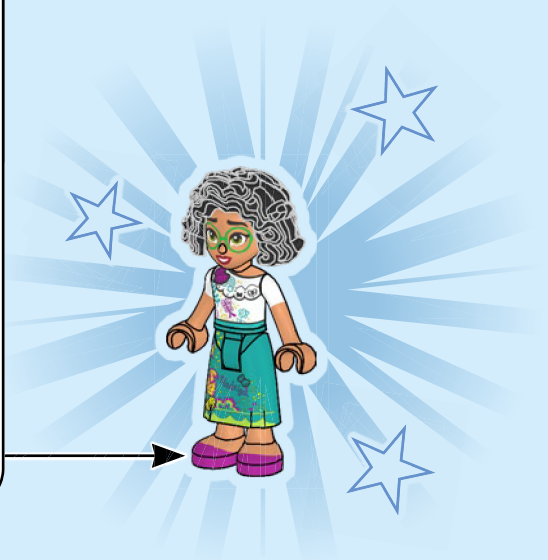
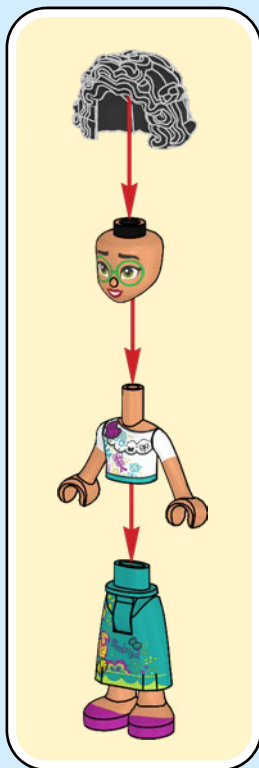

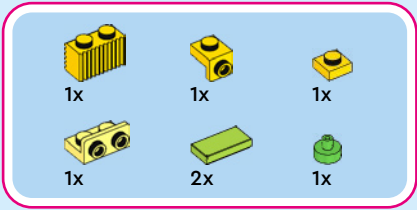

1

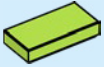

2



3

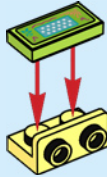

4



5



6



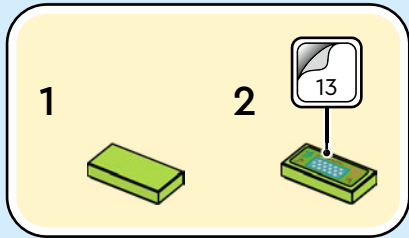

7

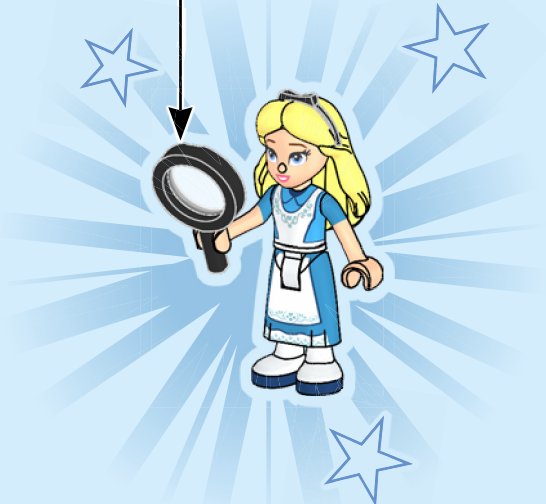



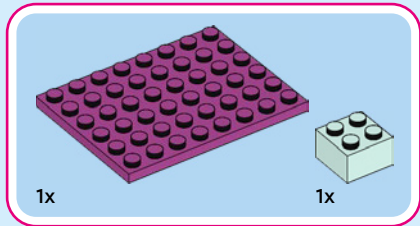
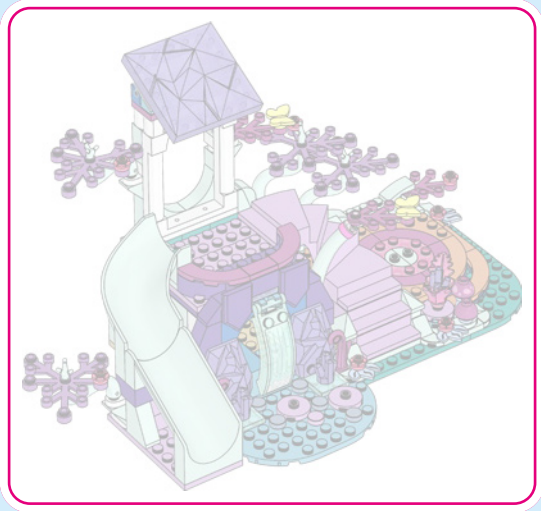

1

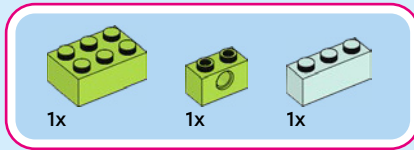
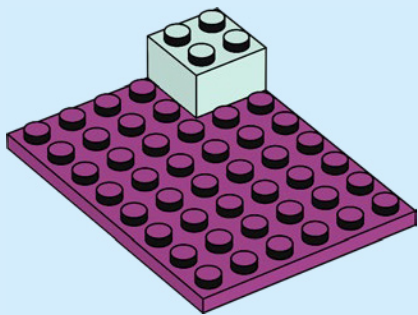

2

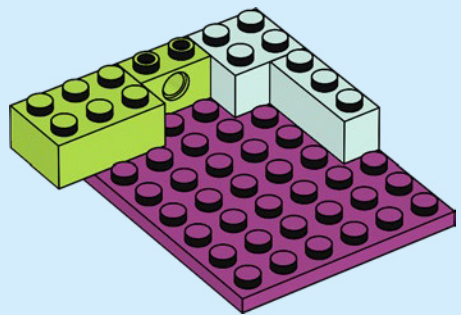

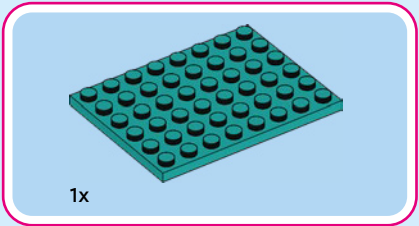

3

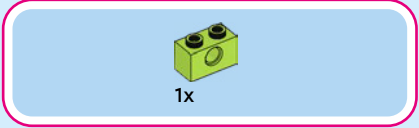
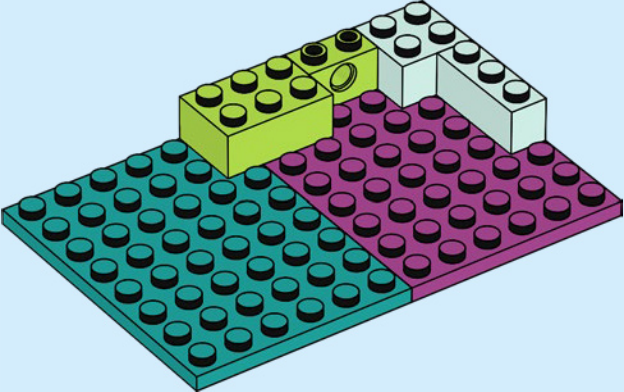

4

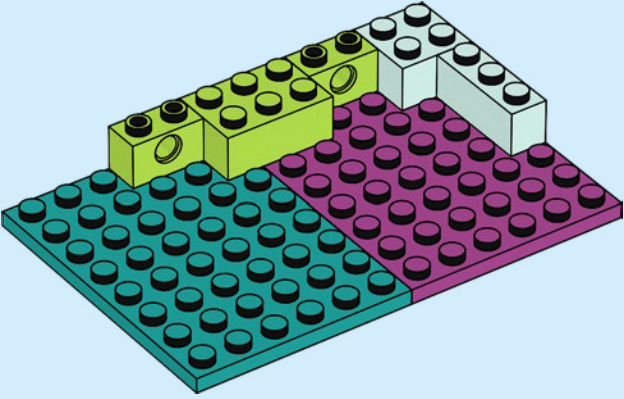

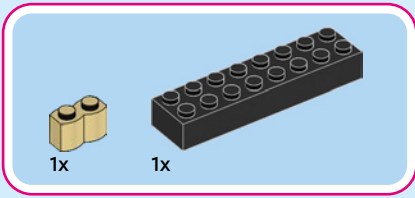

5

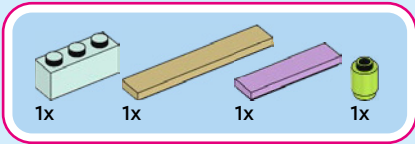
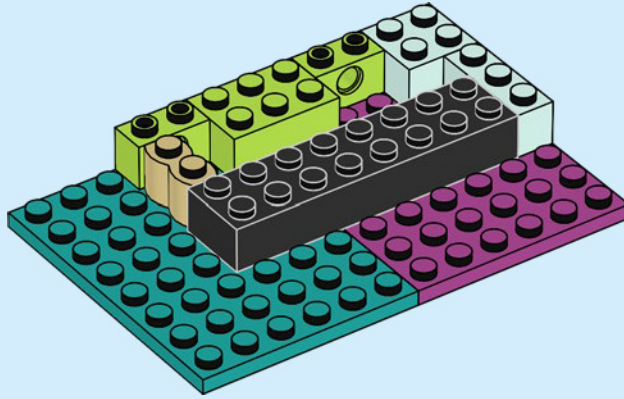

6

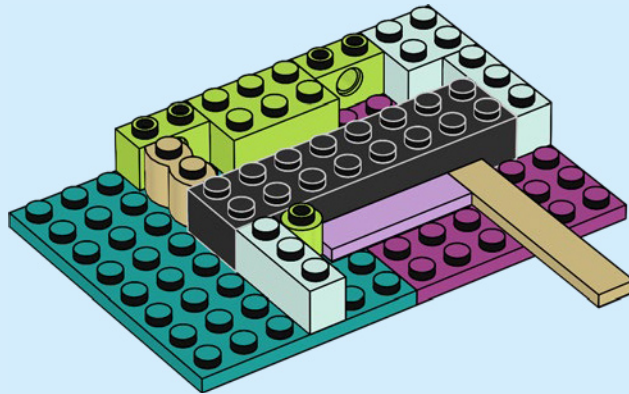

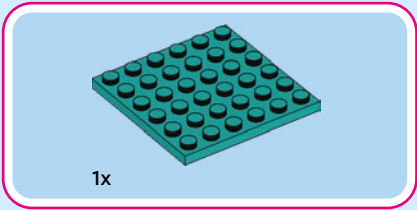

7

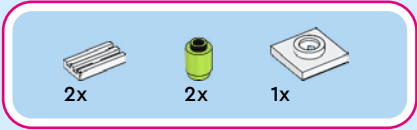
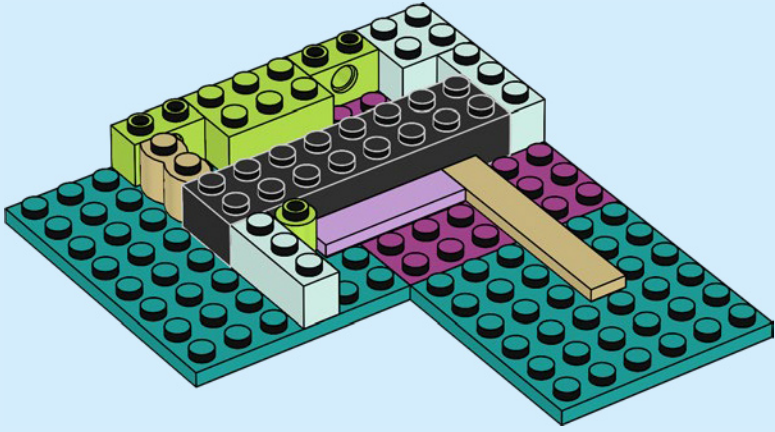

8

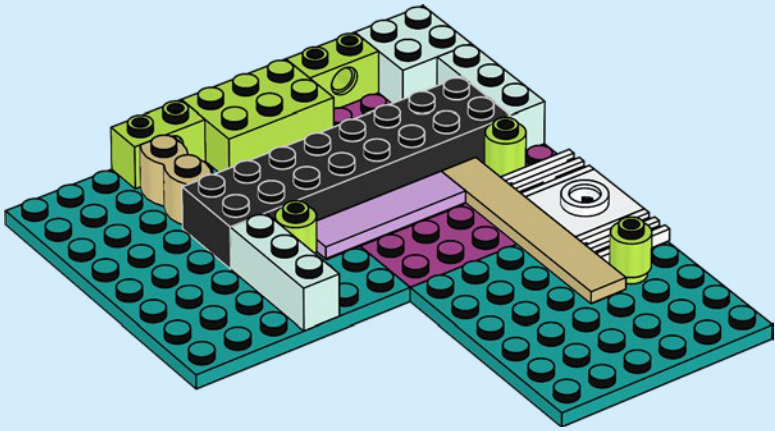

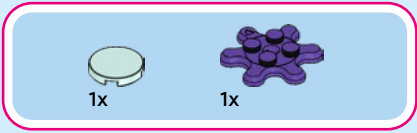

9

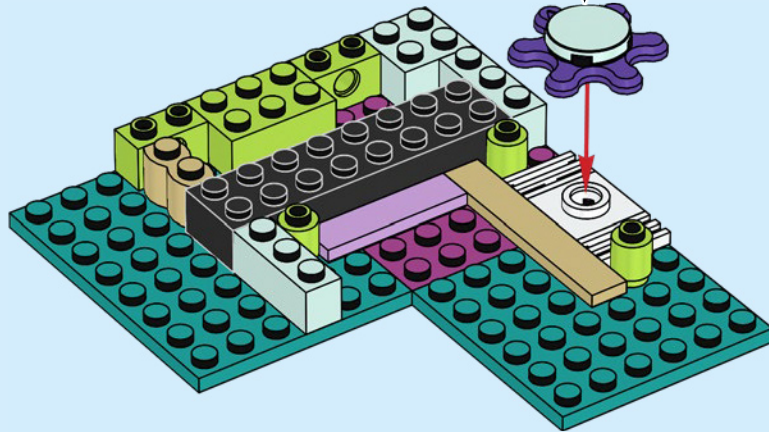
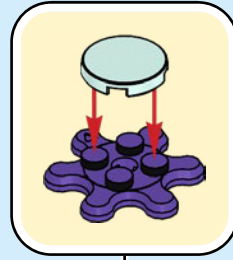

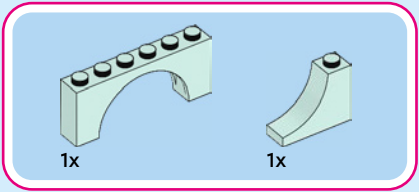

10

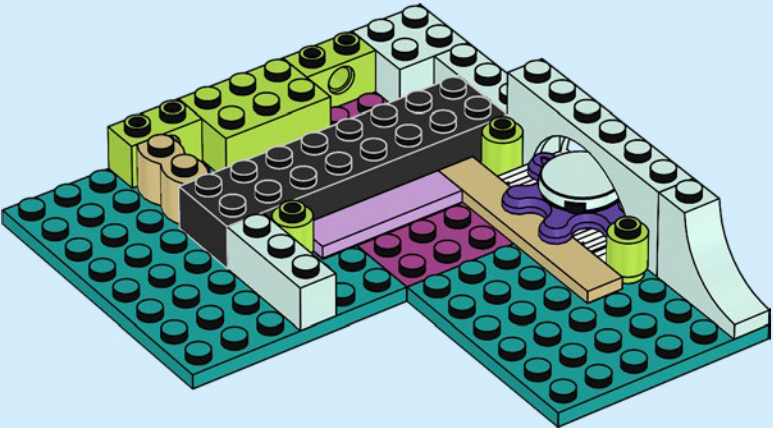

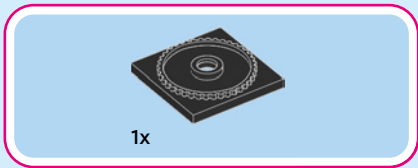

11

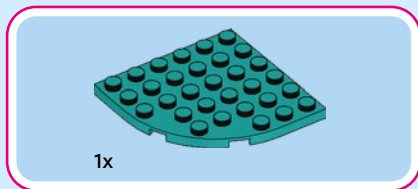
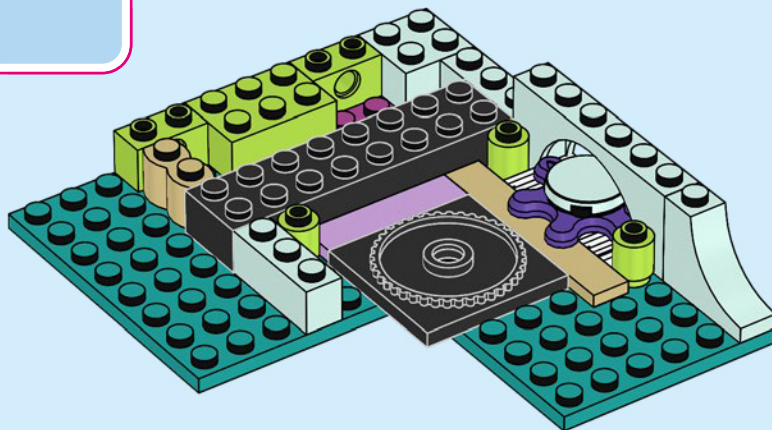

12

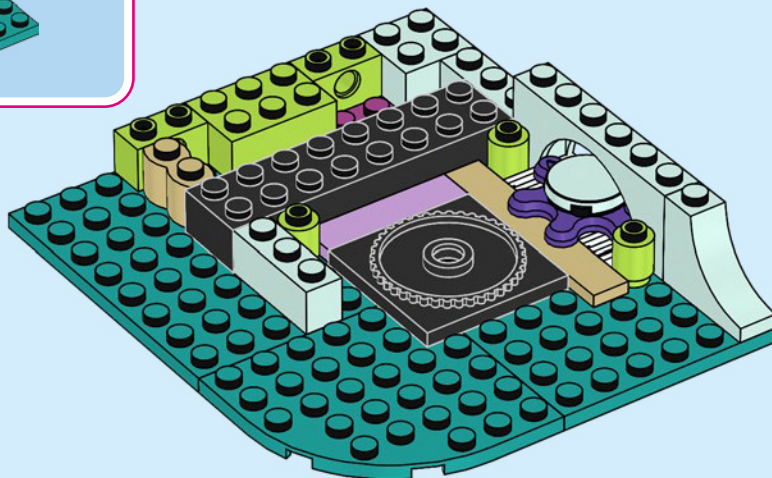



1x

13

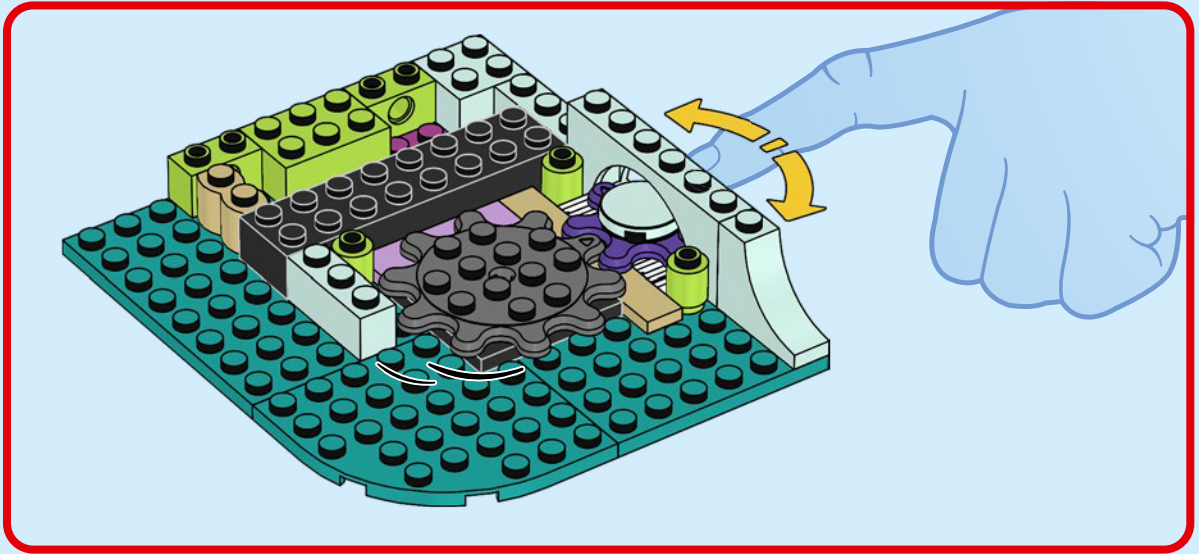
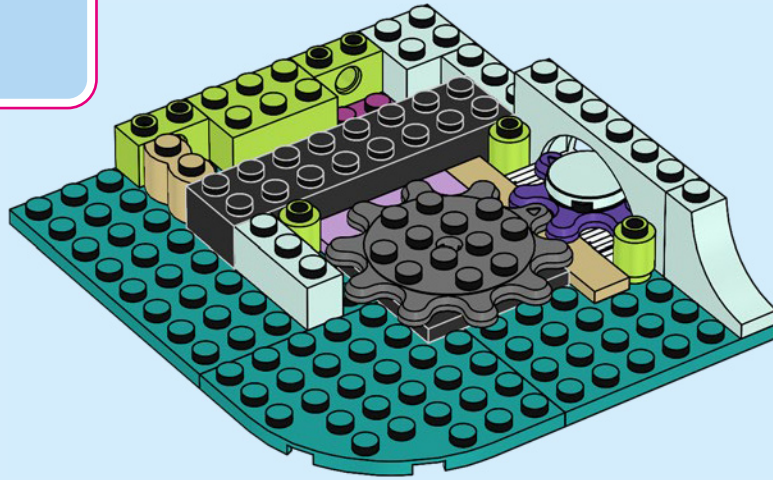



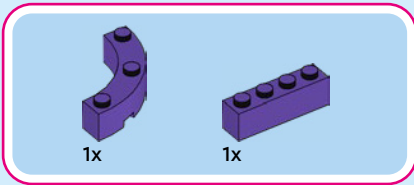

14

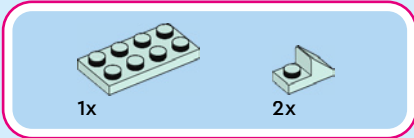
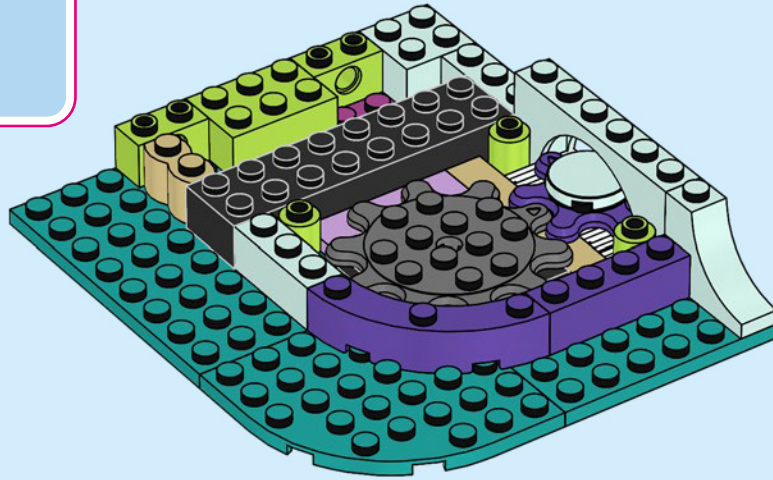

15

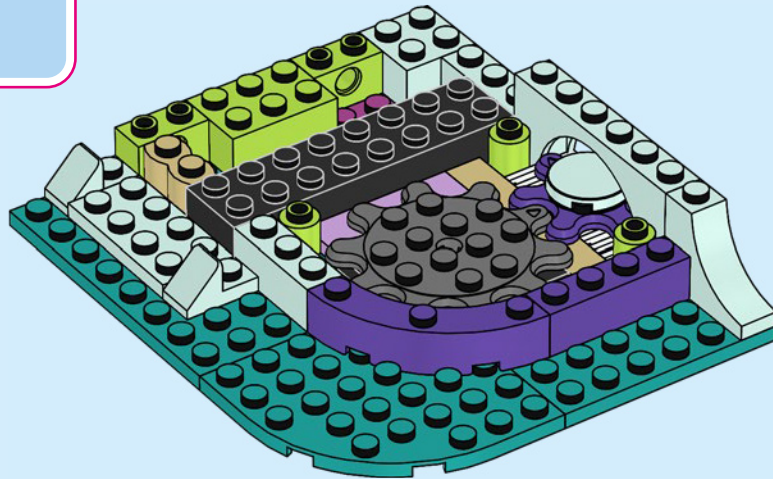

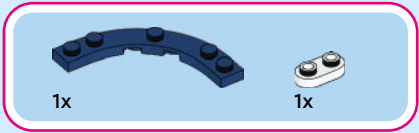

16

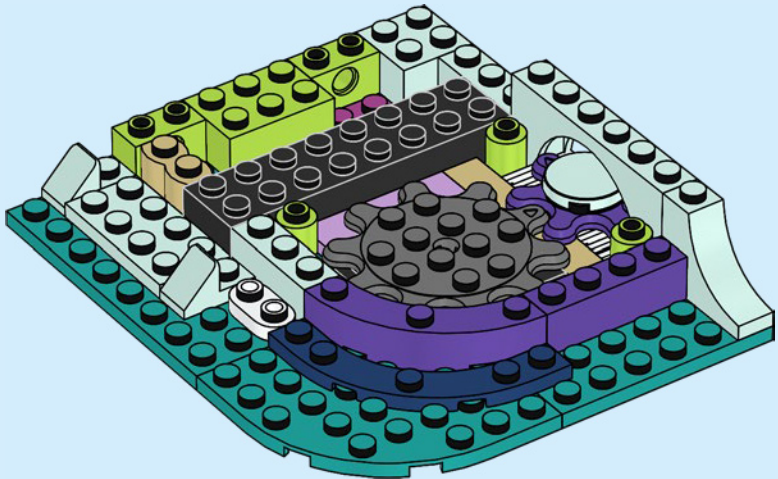

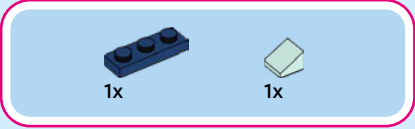

17

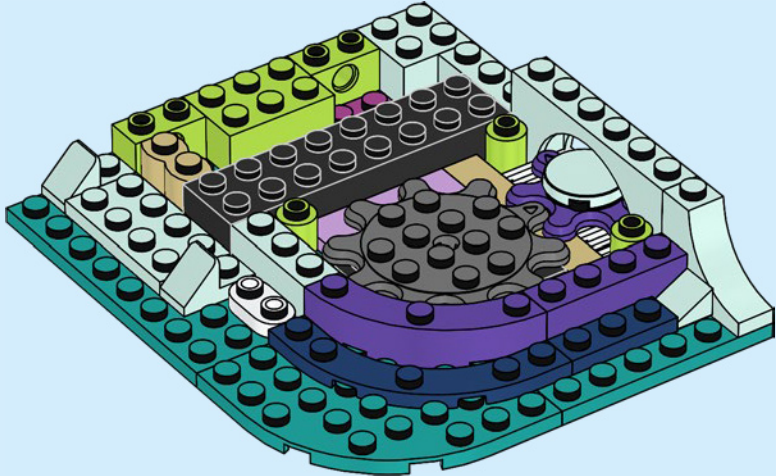

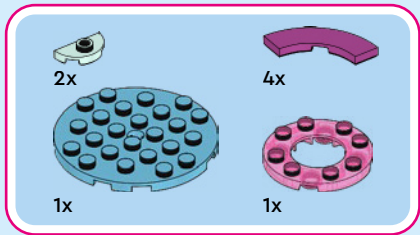

18

1

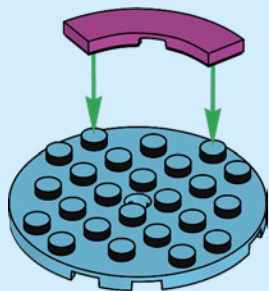

2

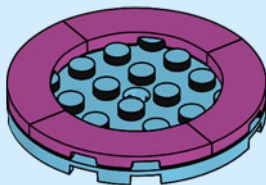

3

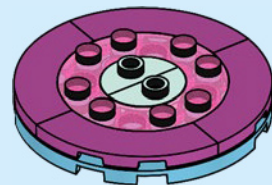

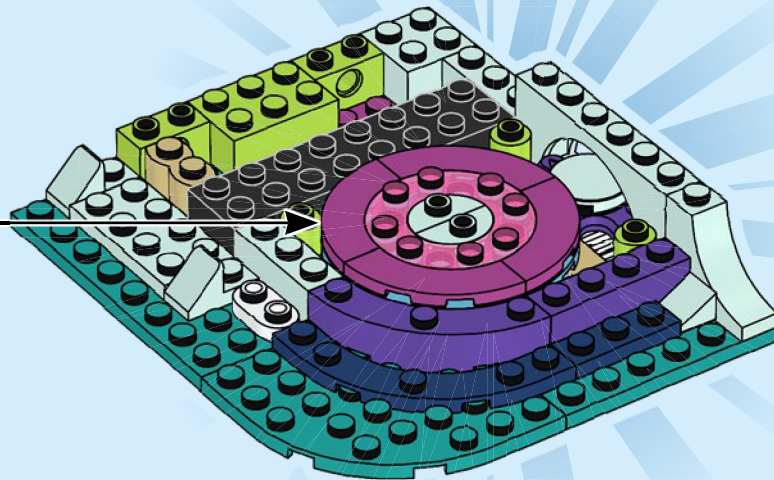

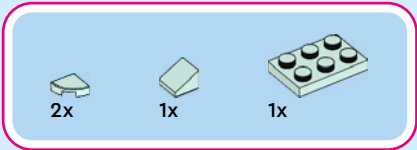

19

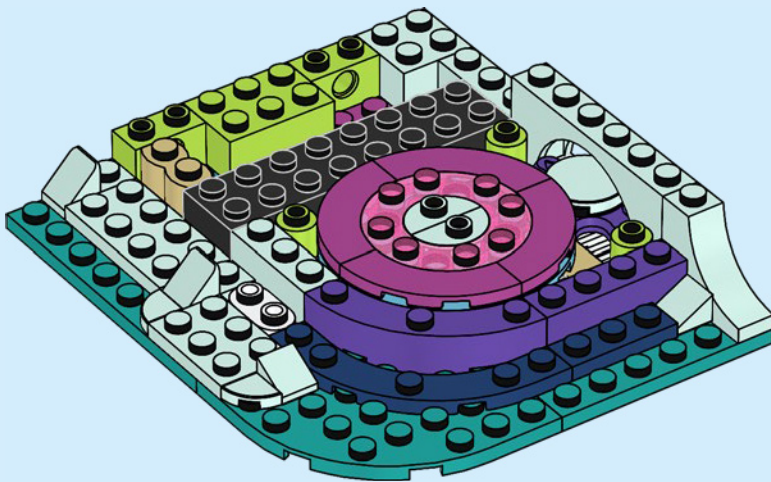

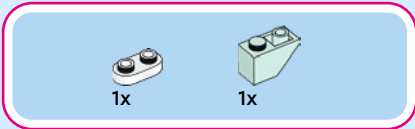

20

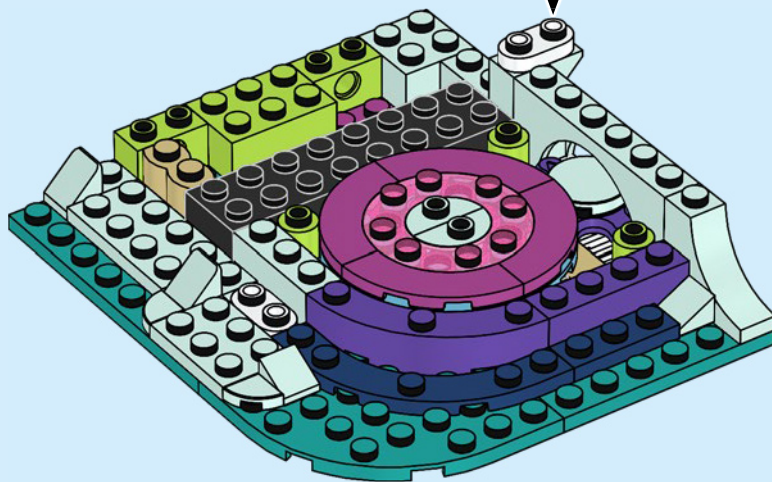
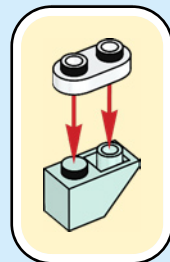

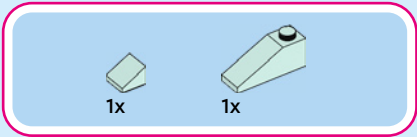

21

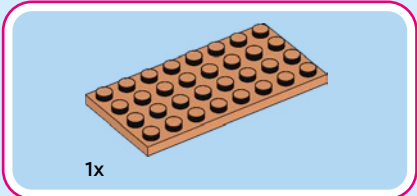
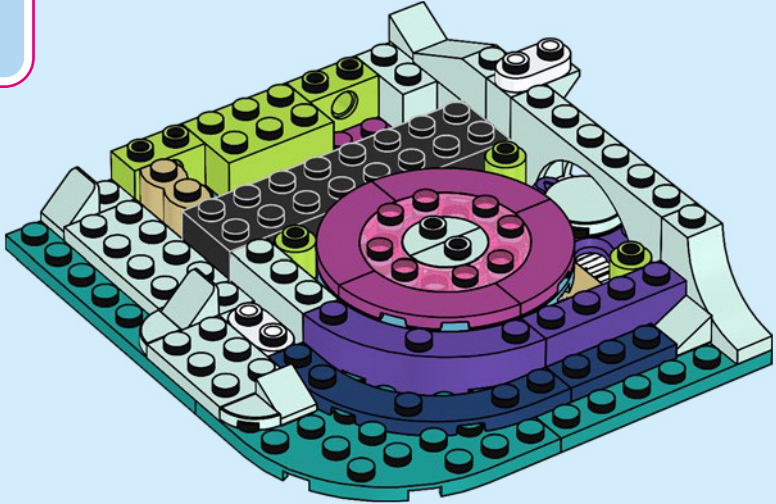

22

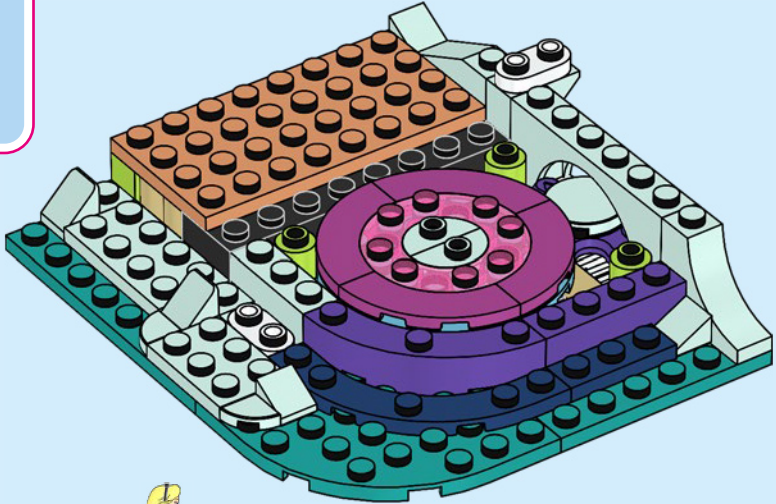



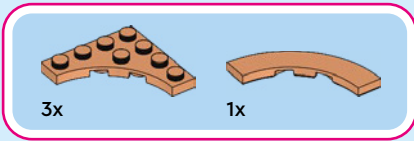

23

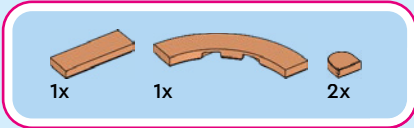
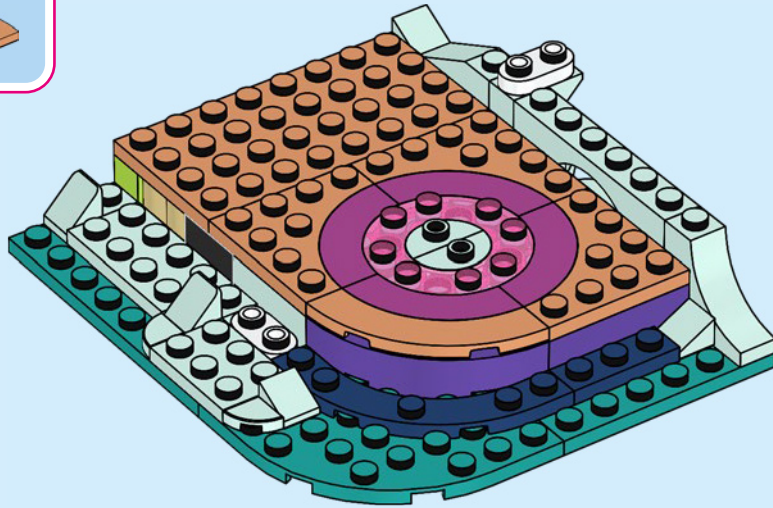

24

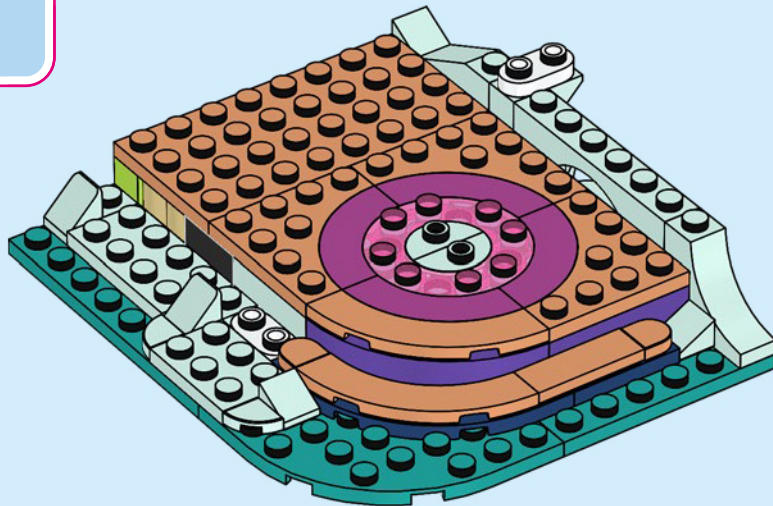

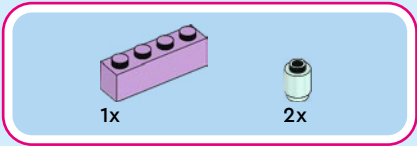

25

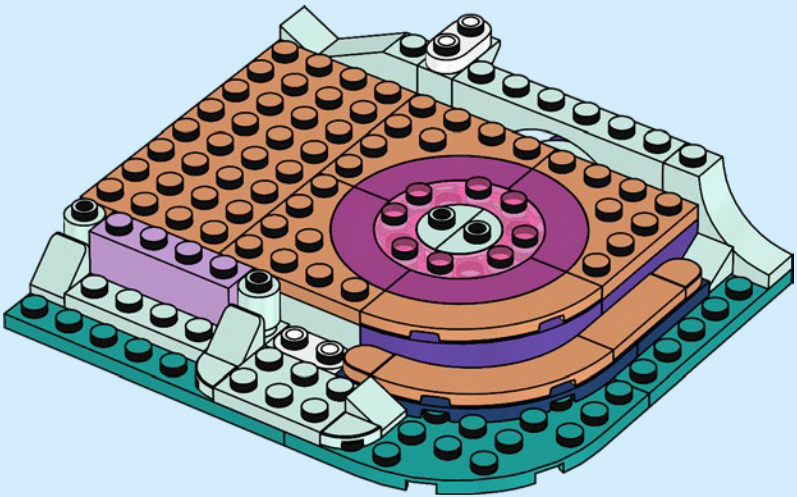



3x



1x

26

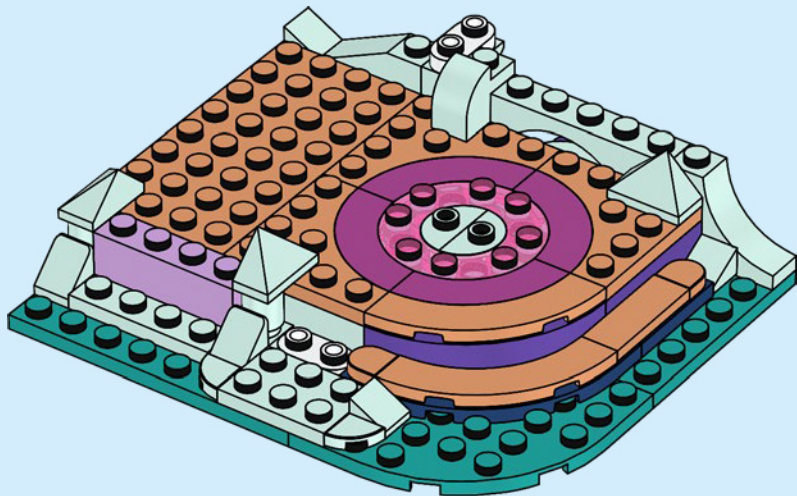

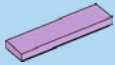

2x

27

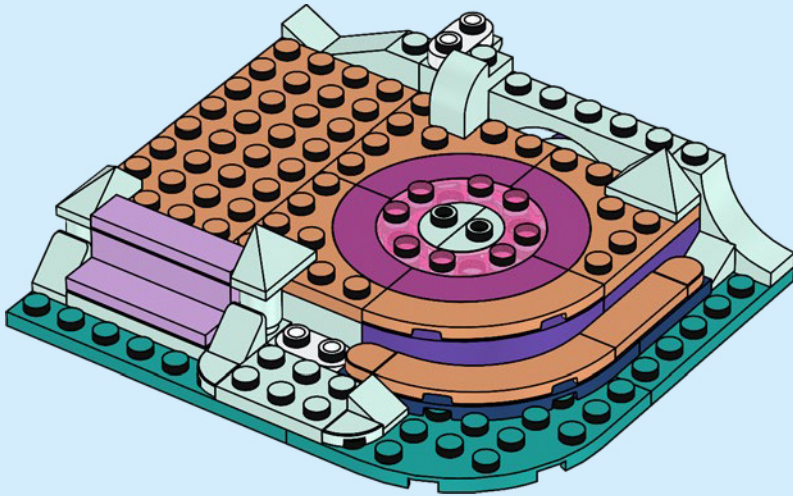

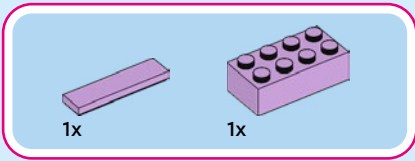

28

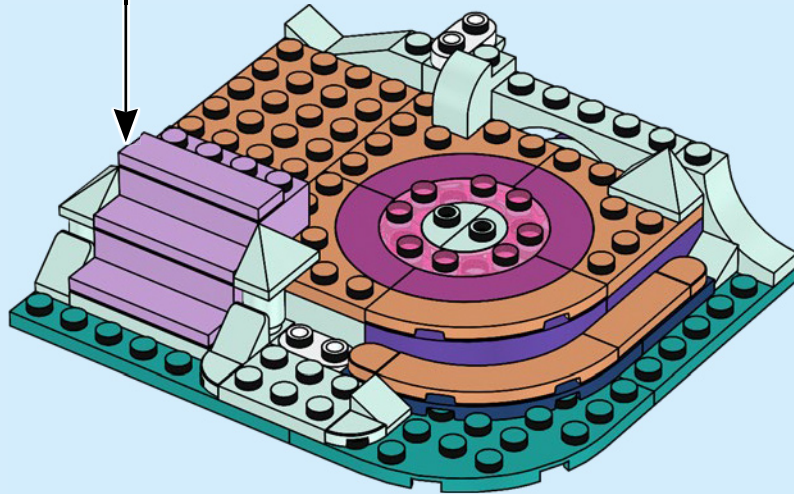
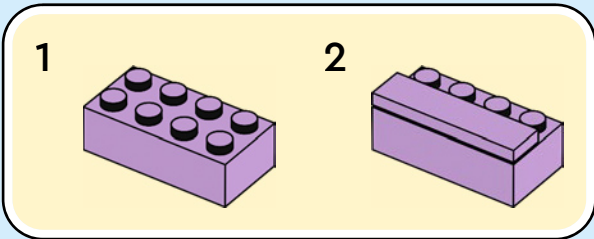

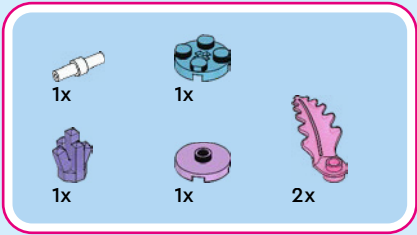

29

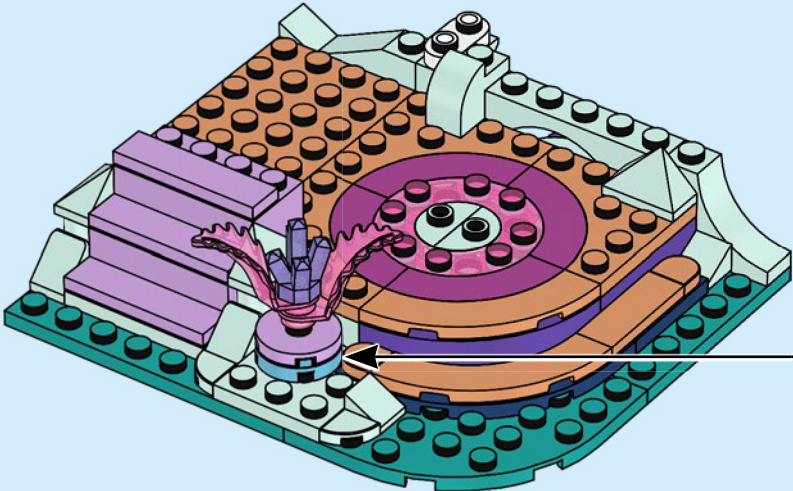
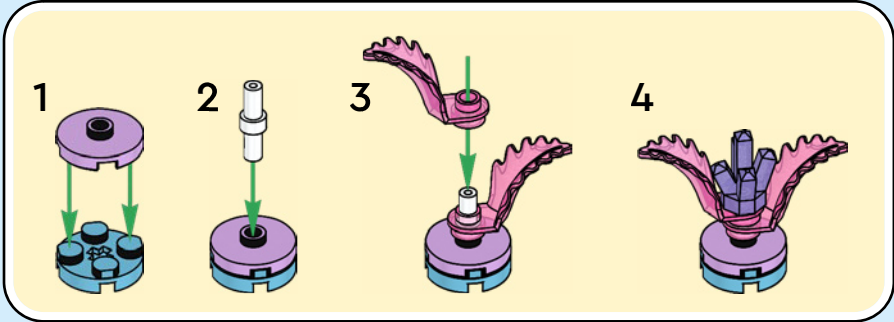



1x

30

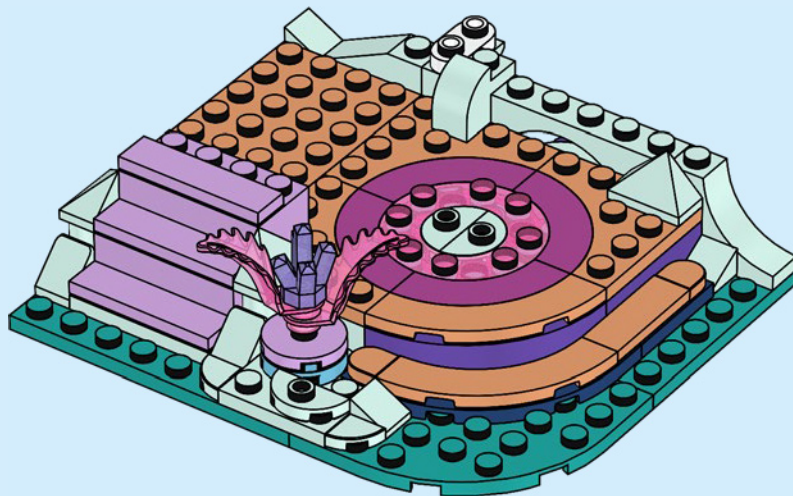



2x



2x

31

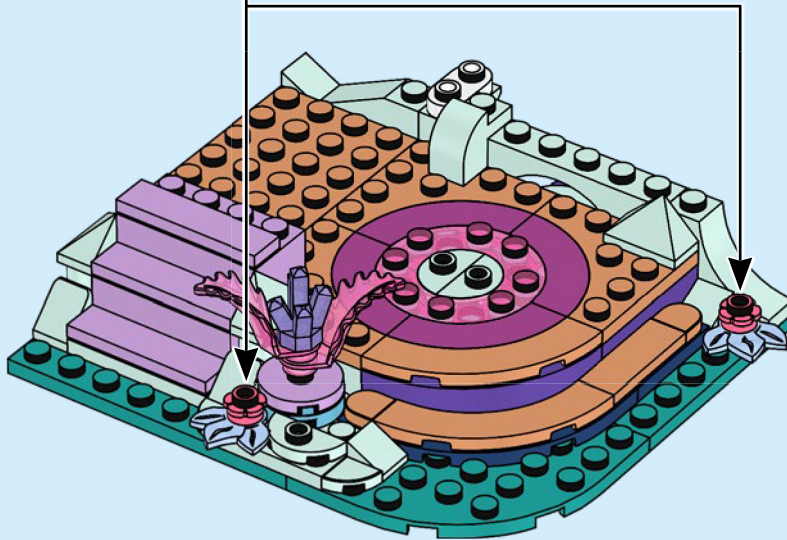
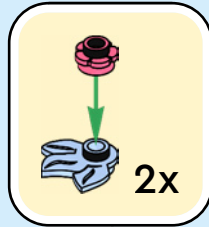





# 32

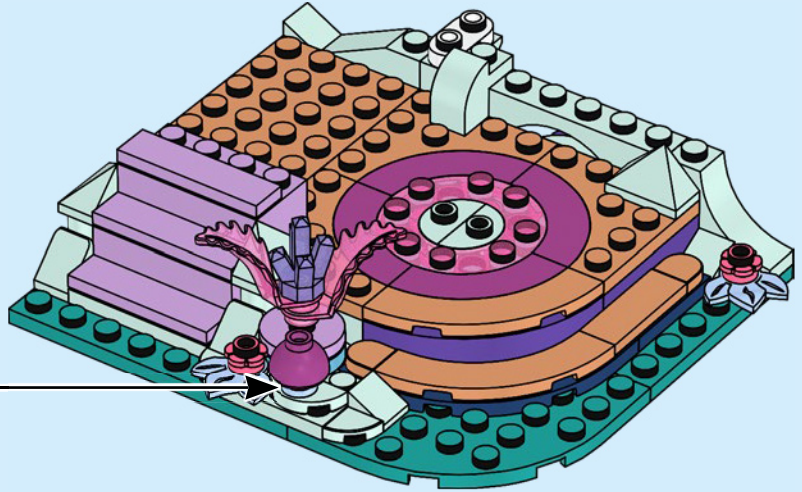
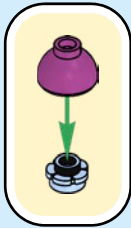

# 33

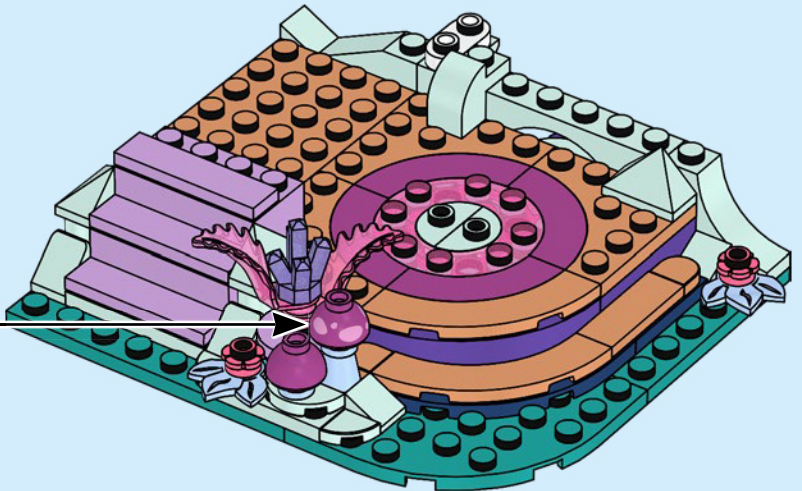
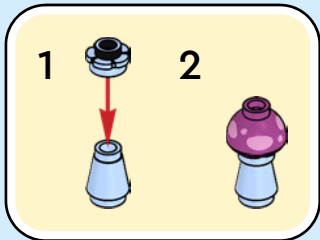



1x



1x

# 34

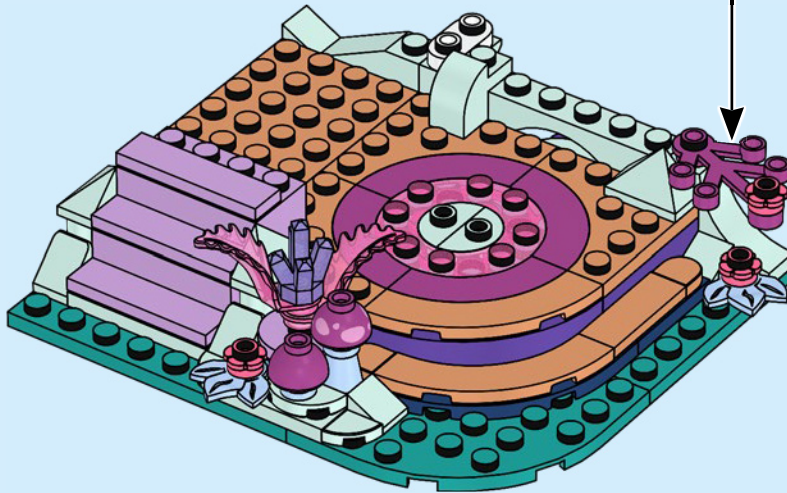
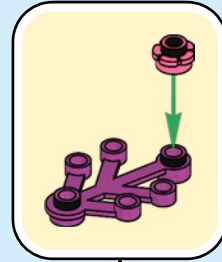



3x

35

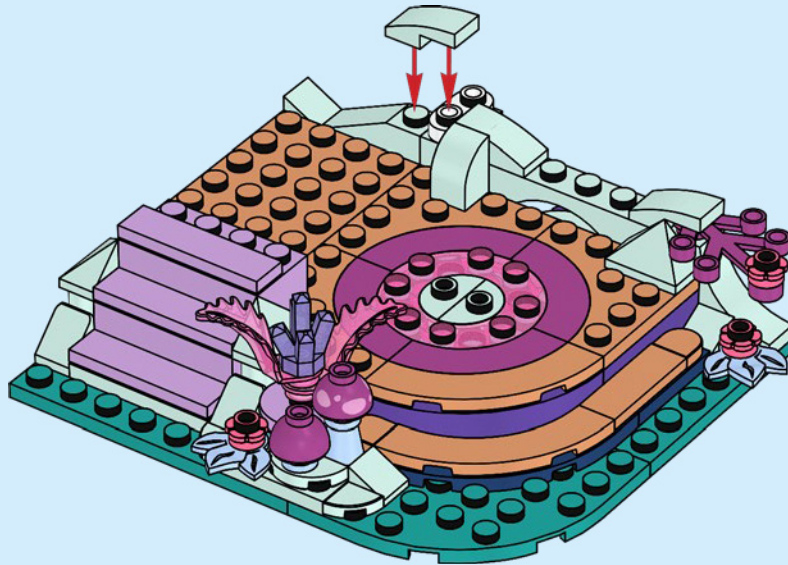



2x

36

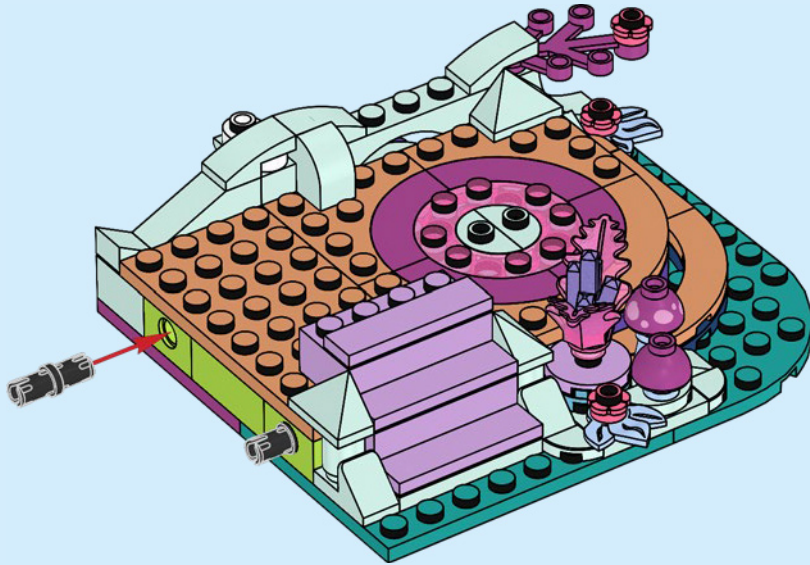

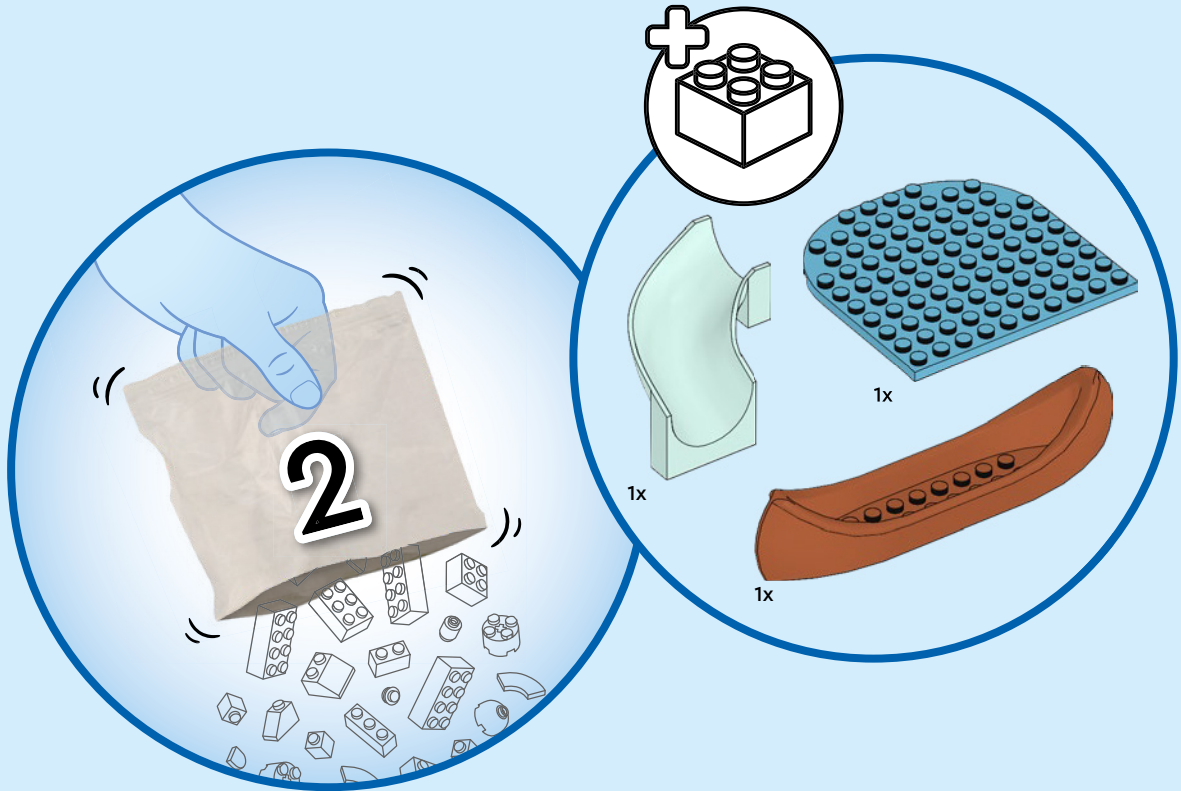

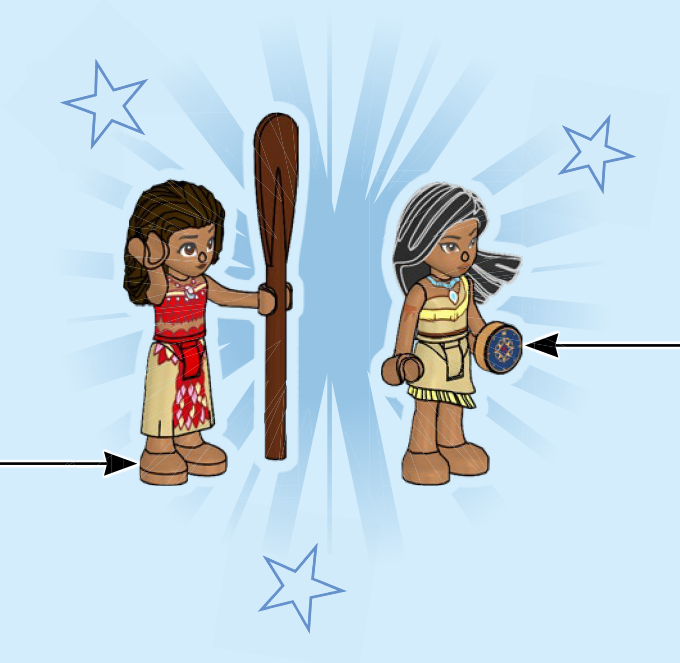
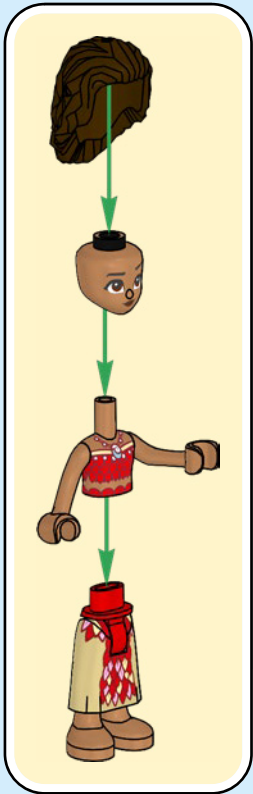

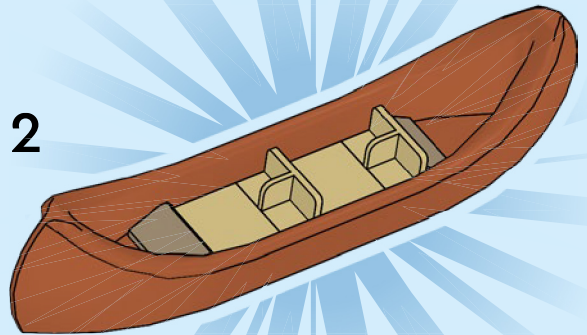
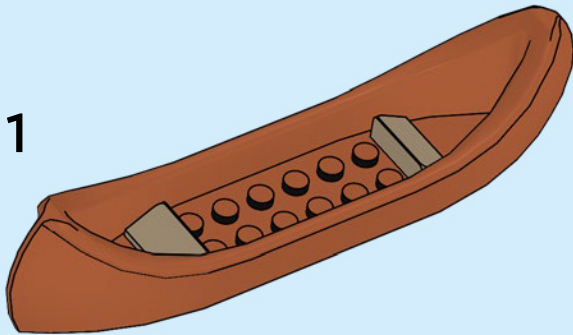
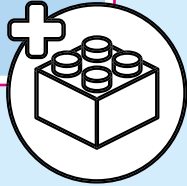
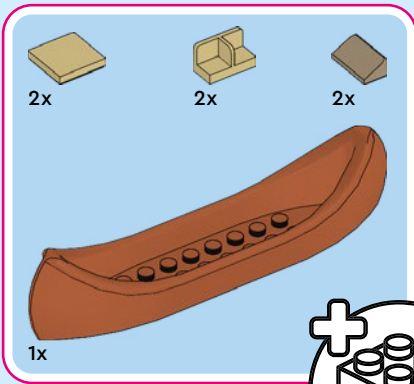







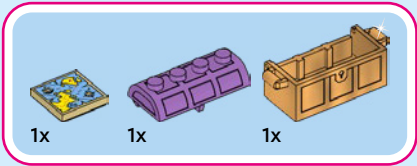

39

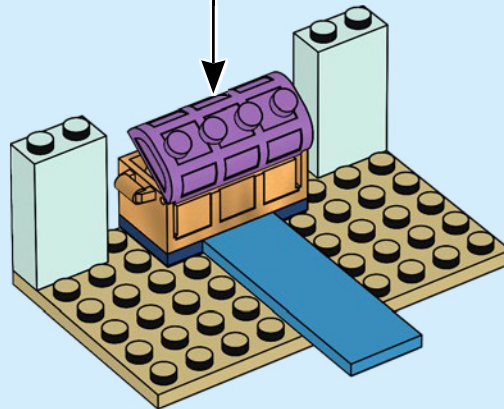
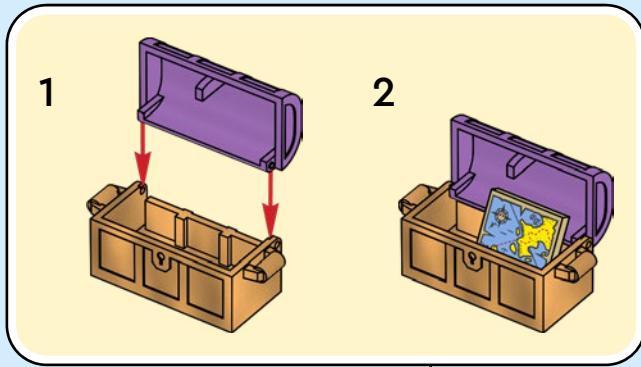

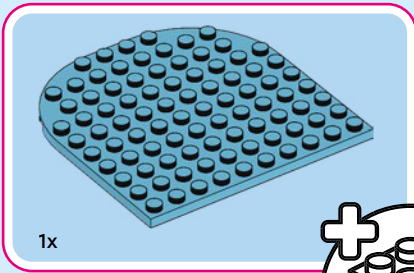

40

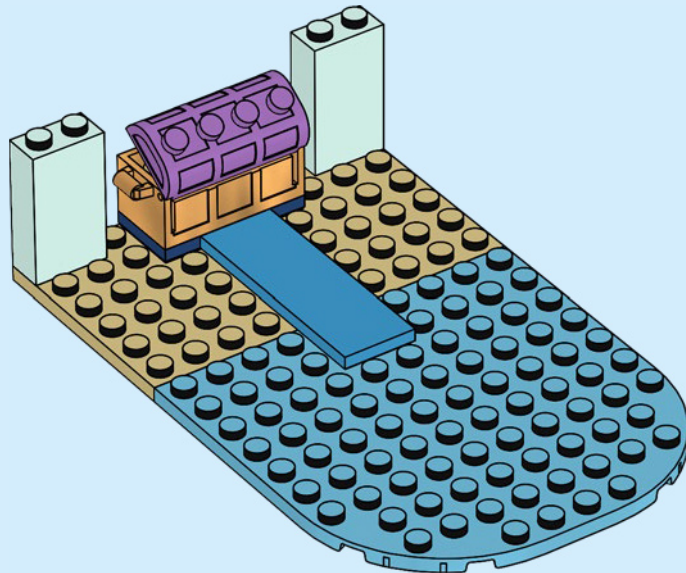
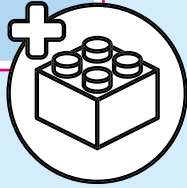





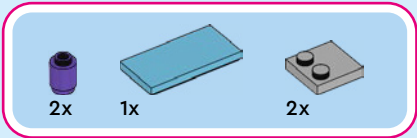

43

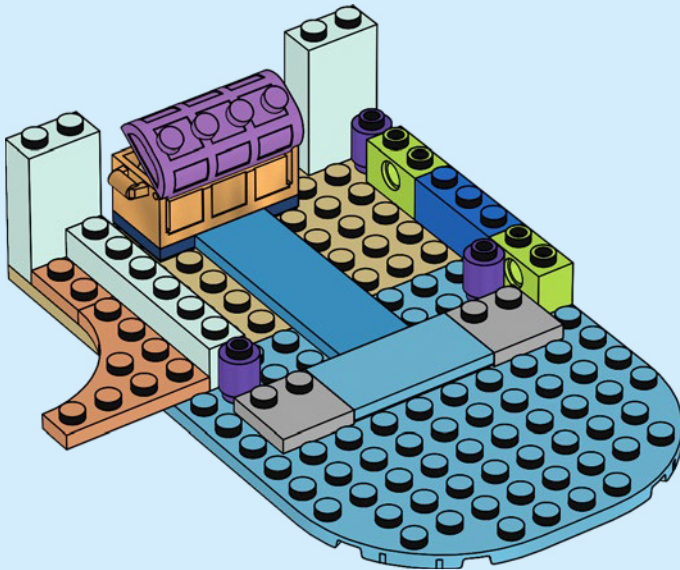



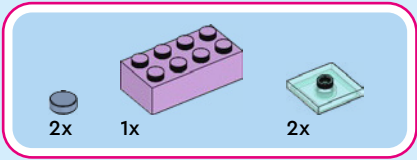

45

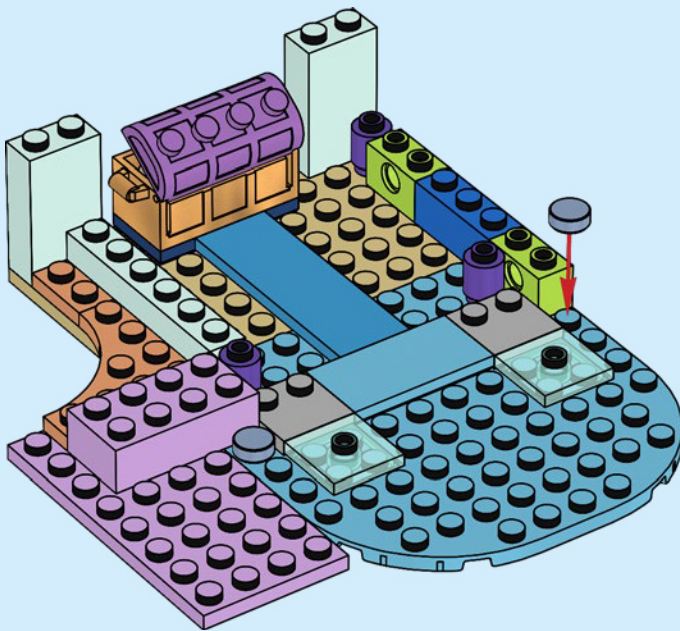





1x



4x

46

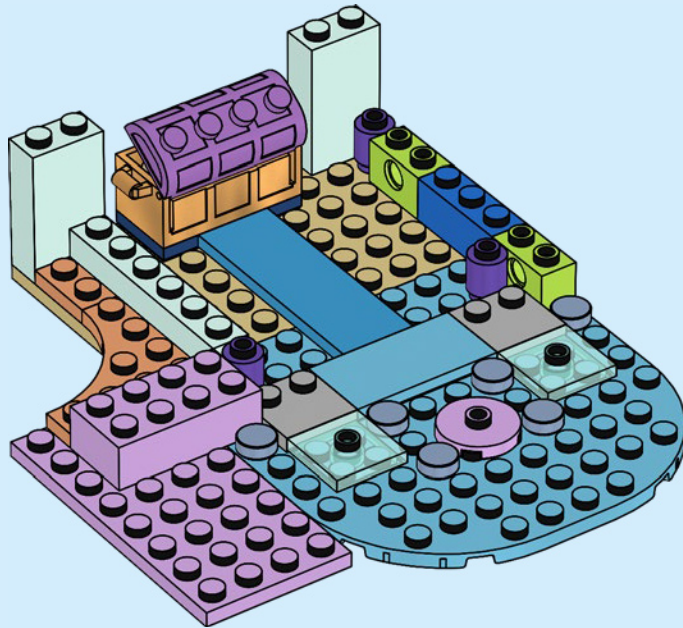

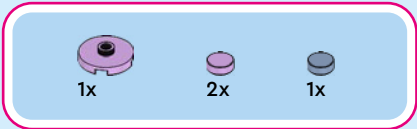

47

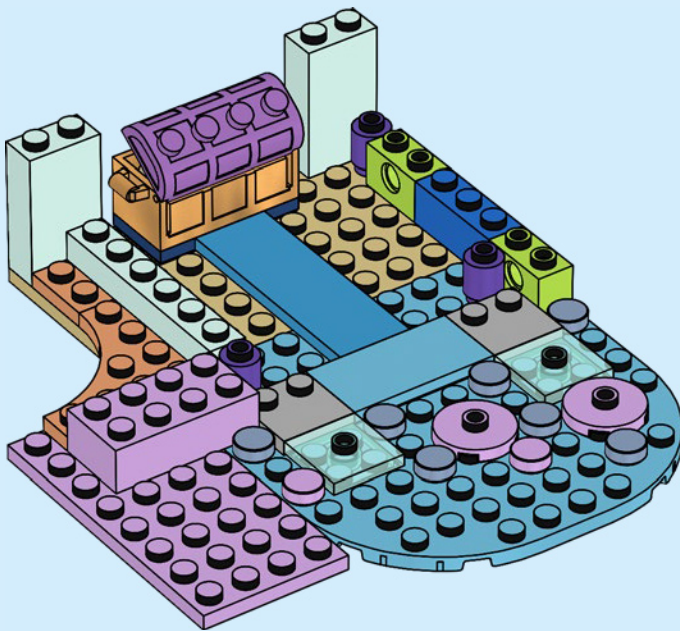



1x



1x

# 48

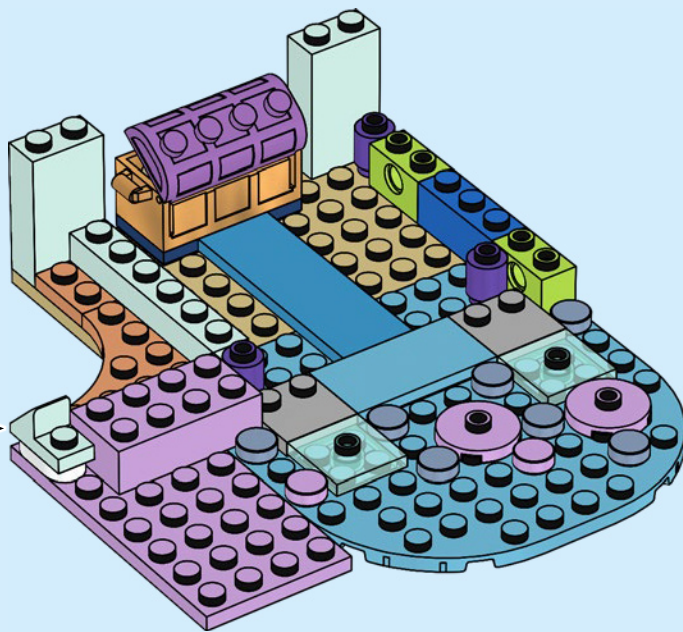
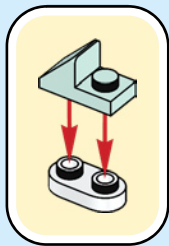



2x

49

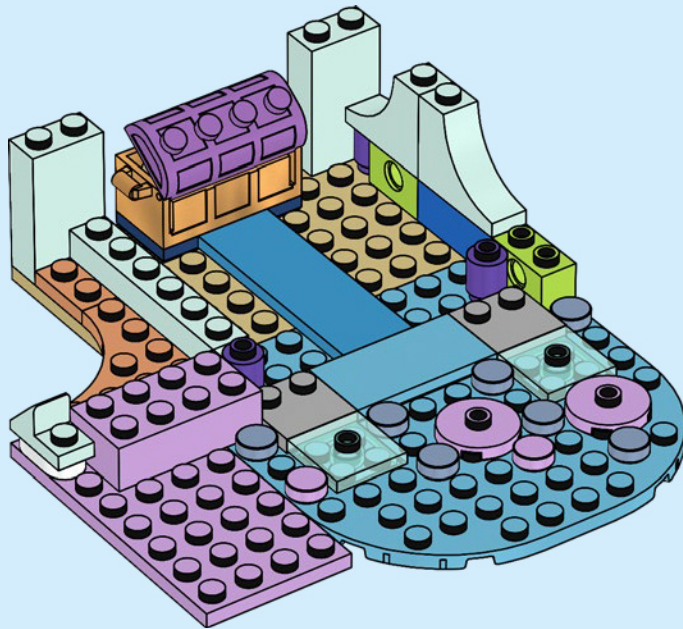



1x



1x

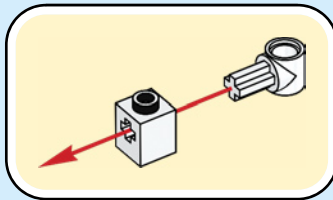

50

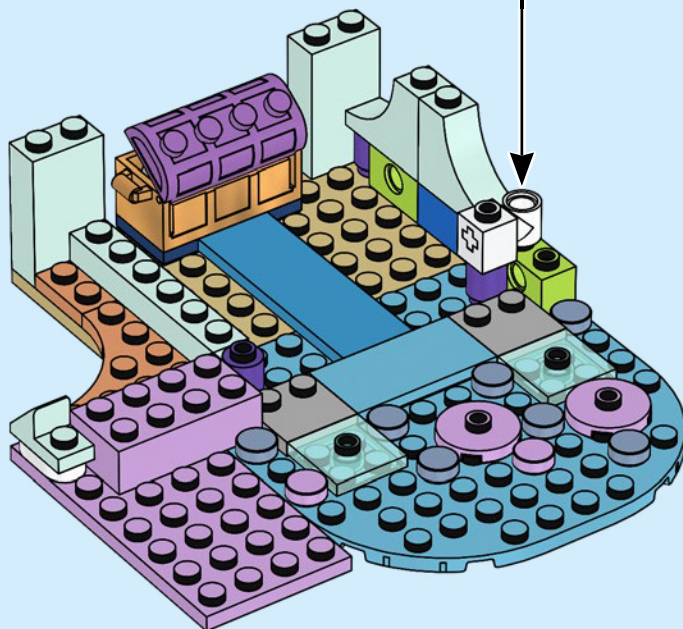



1x



1x

# 51

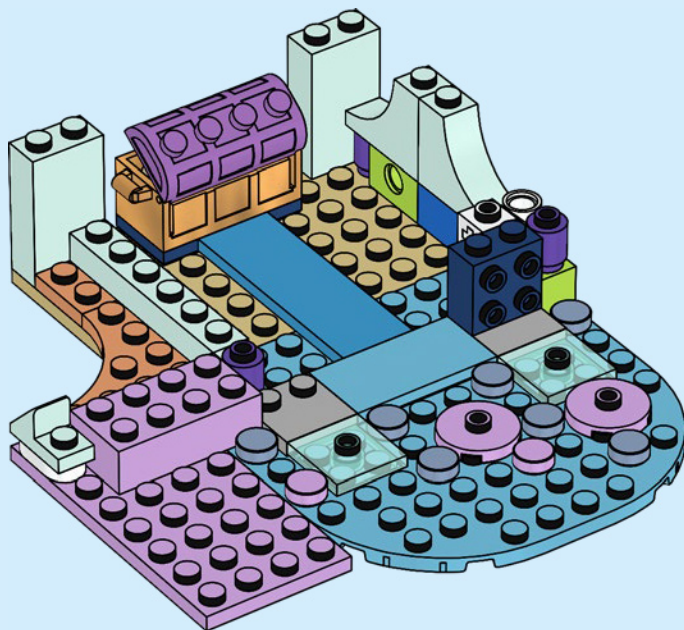



1x



1x

# 52

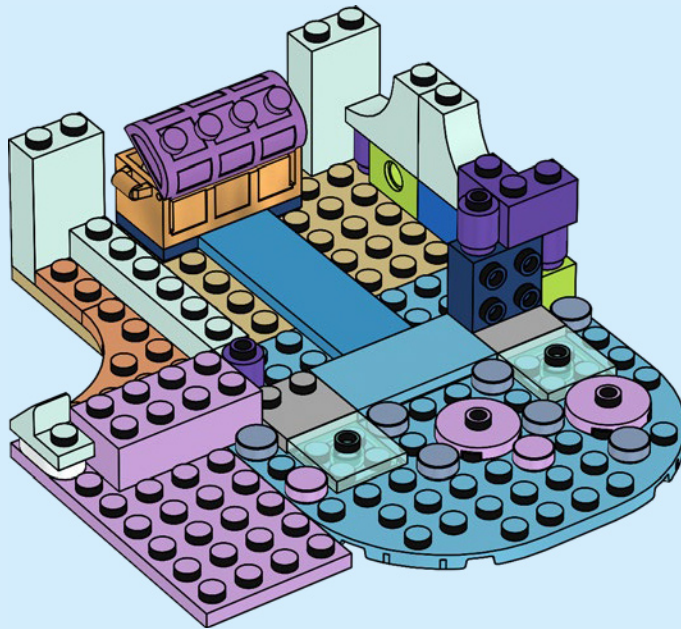

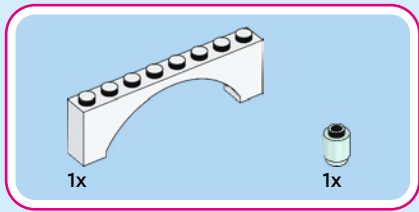

53

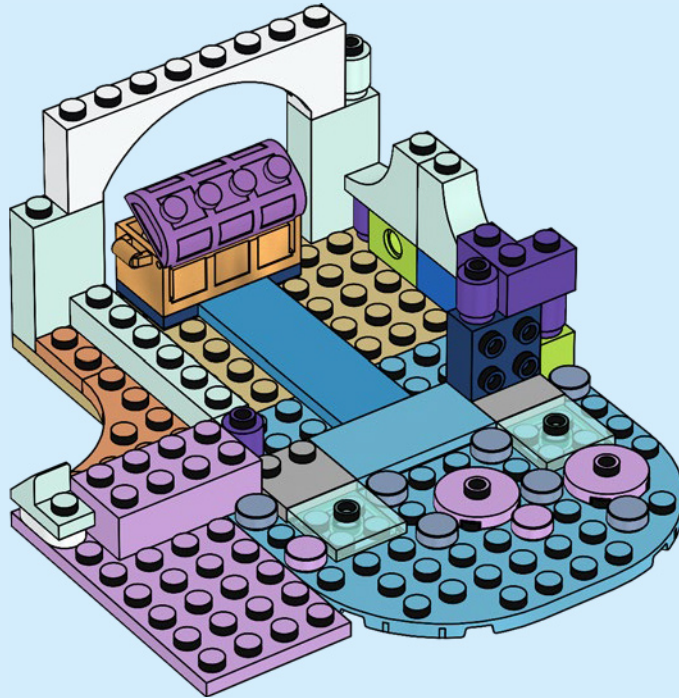



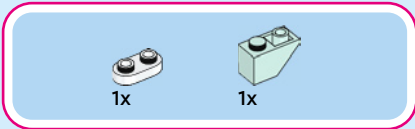

54

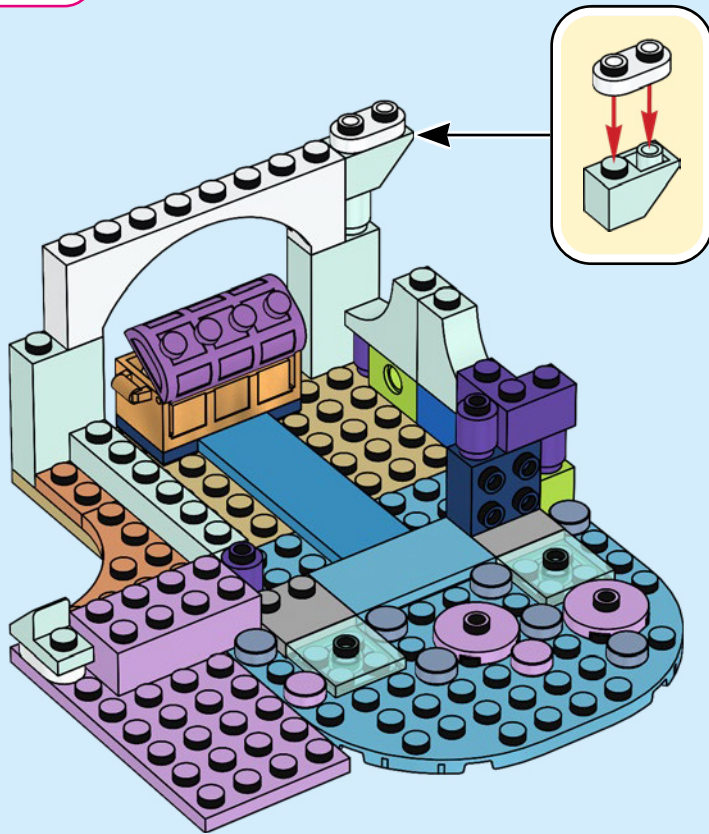

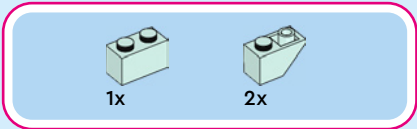

55

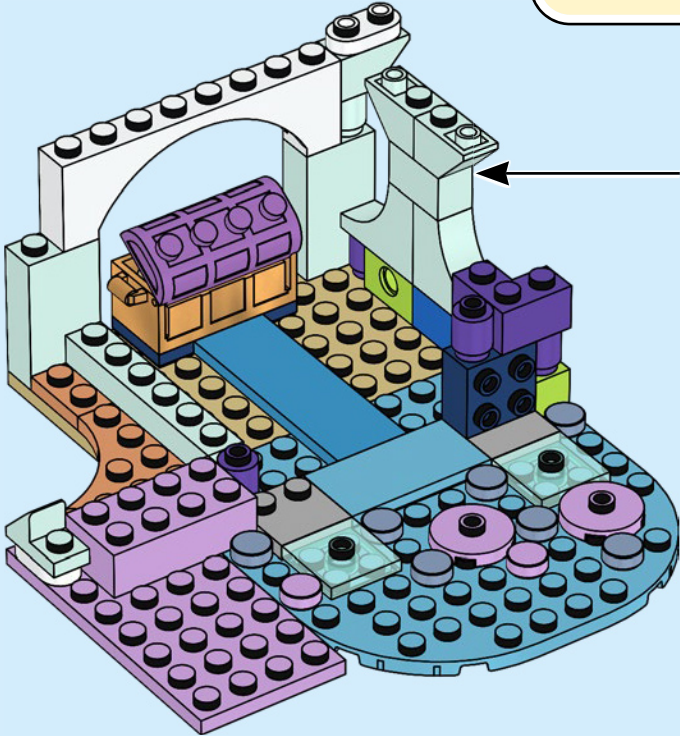
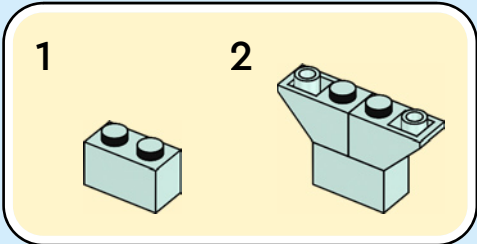

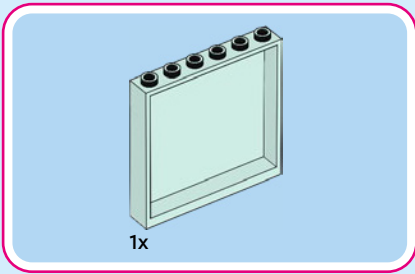

56

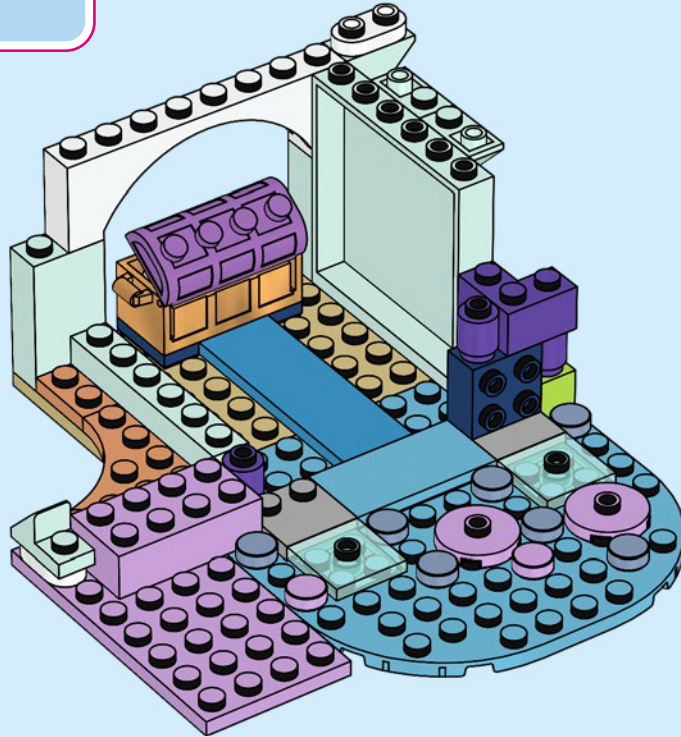

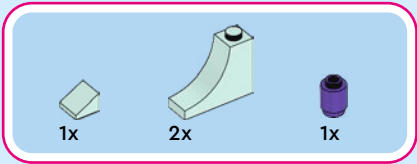

57

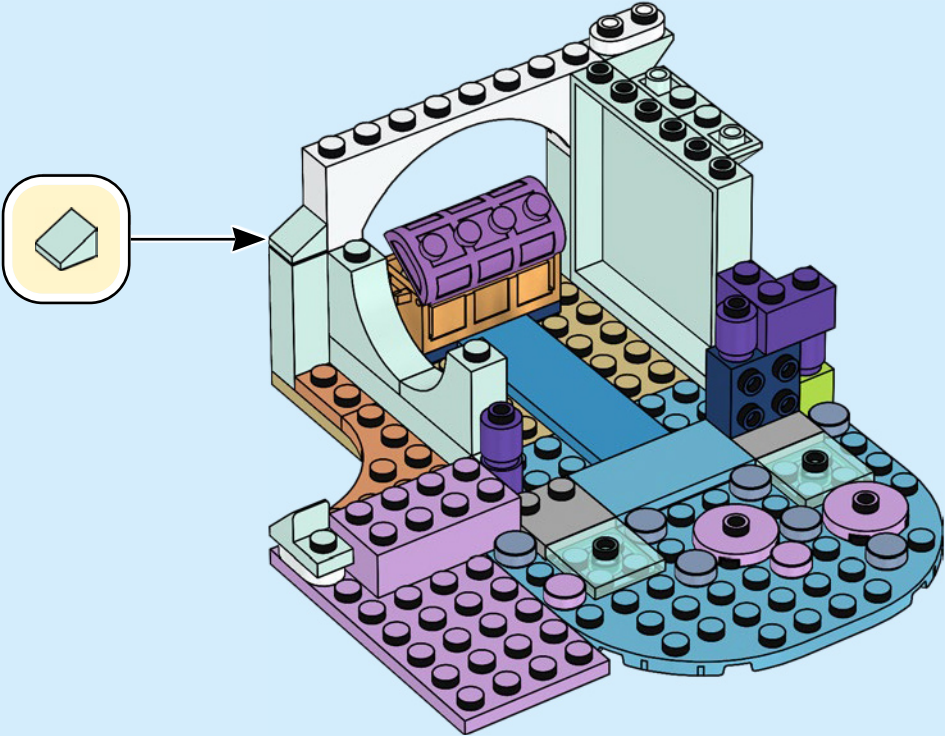

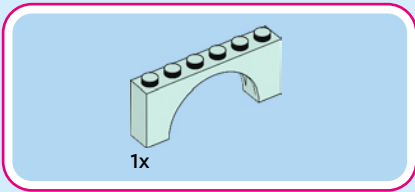

58

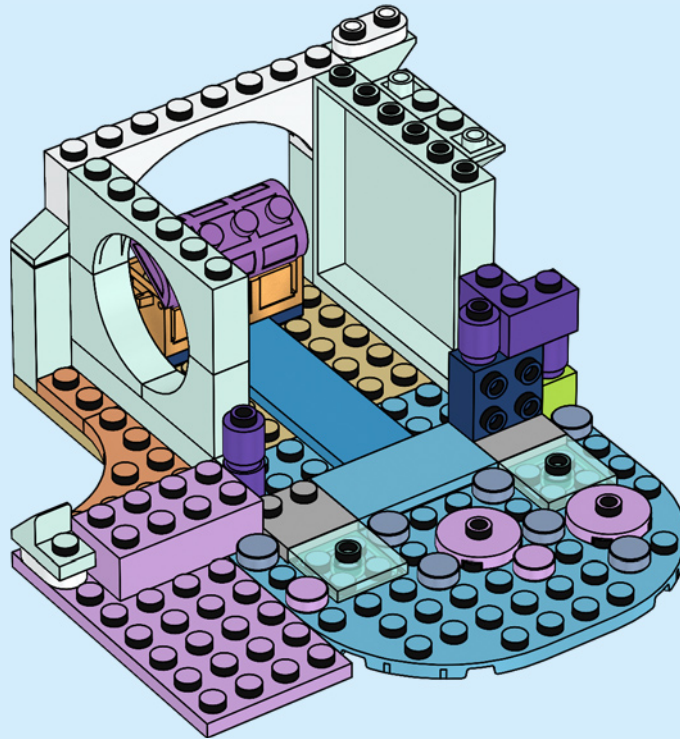

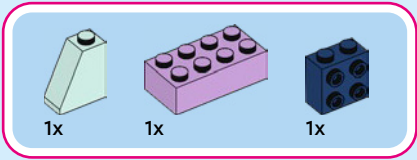

59

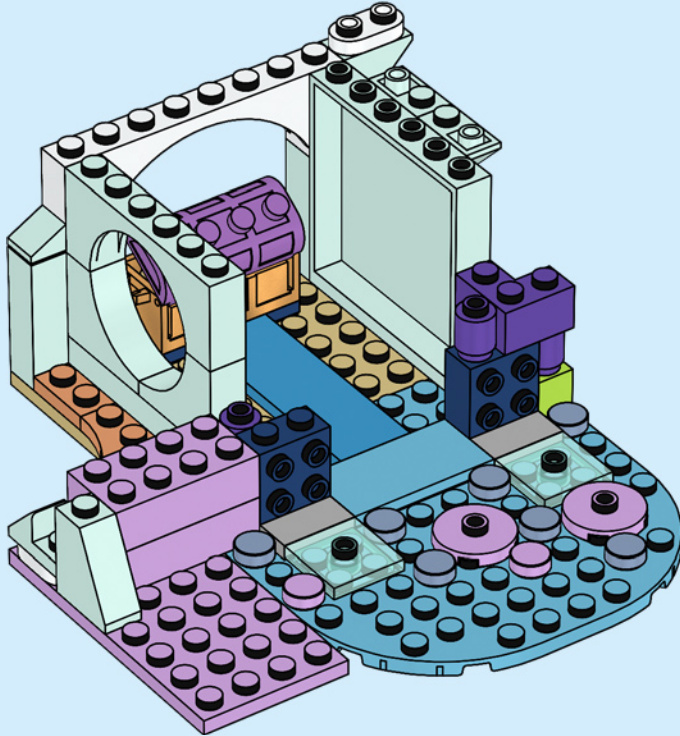



1x



1x

60

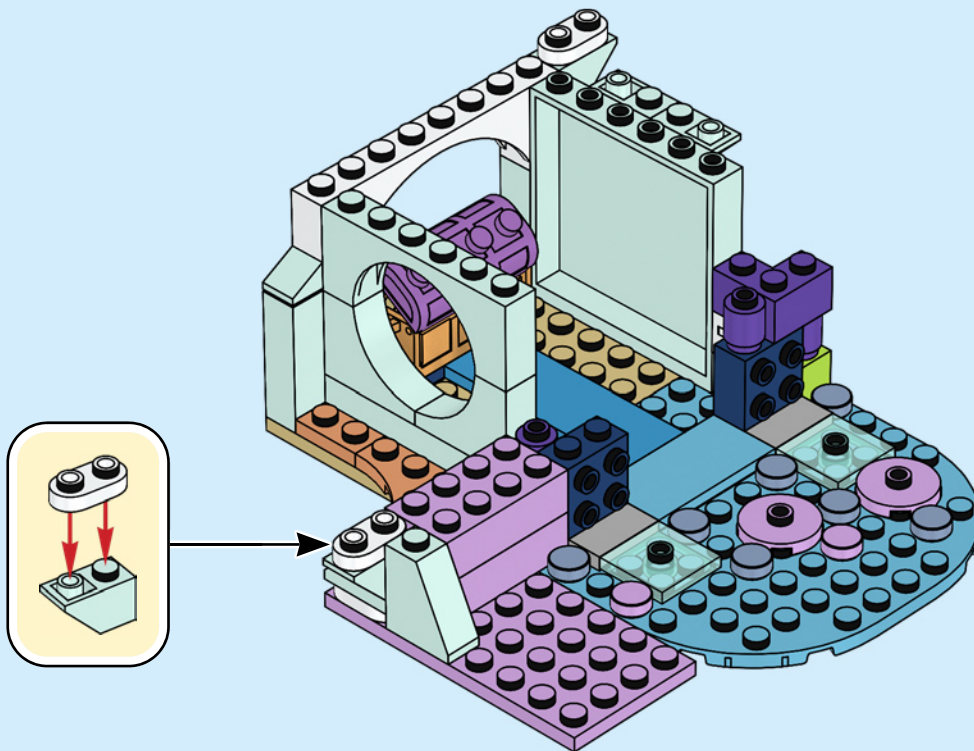

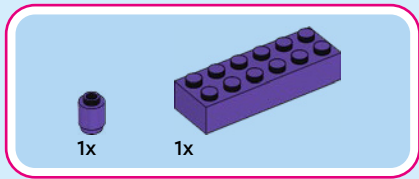

61

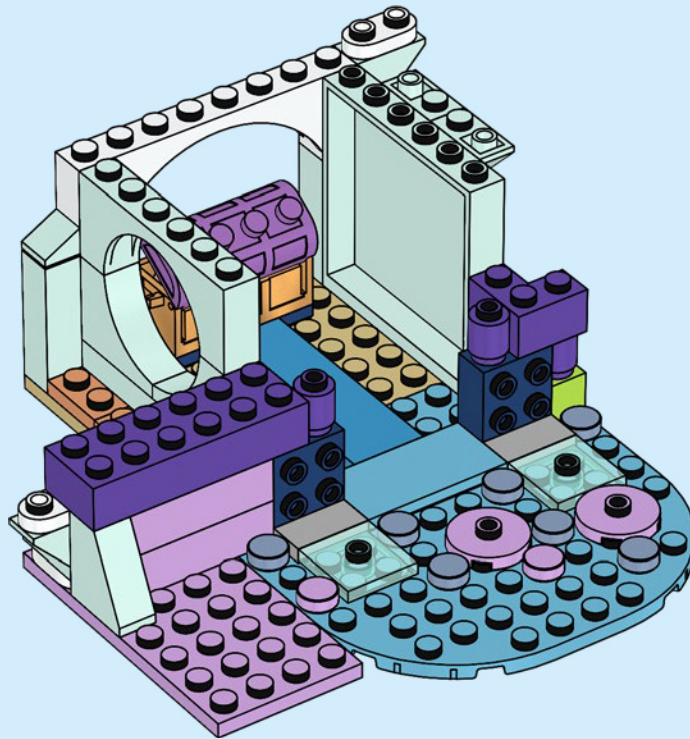



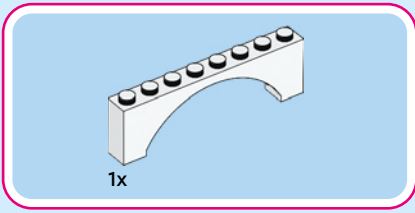

62

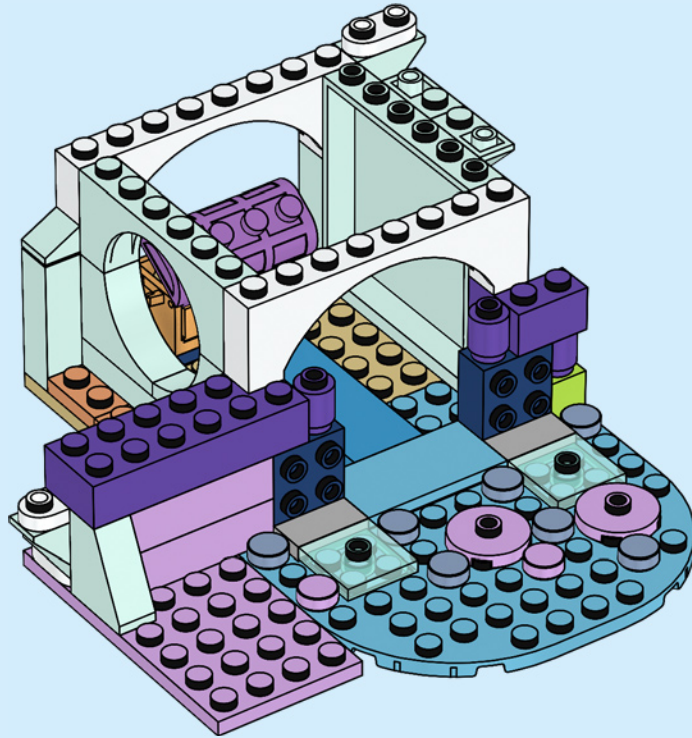

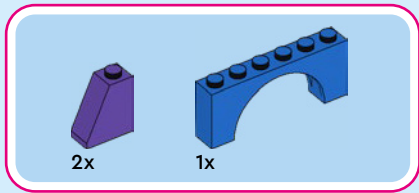

63

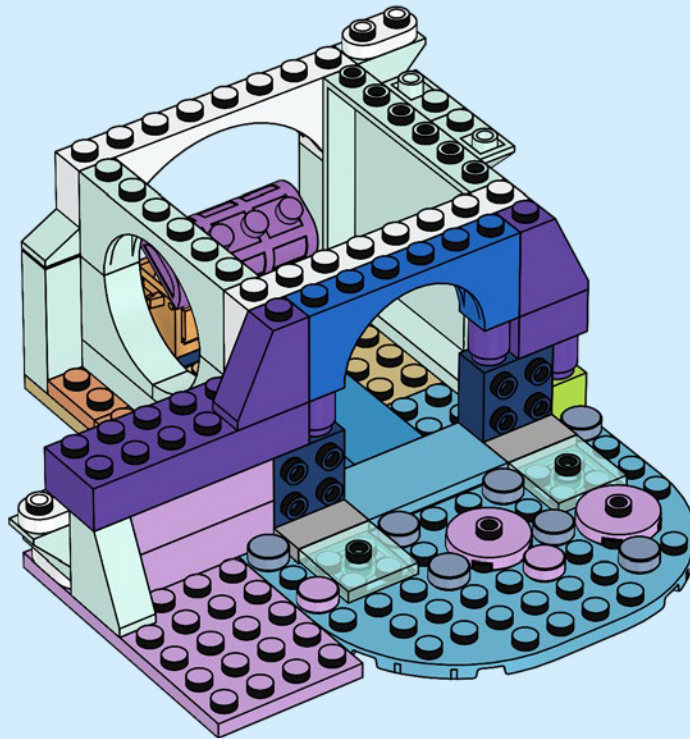

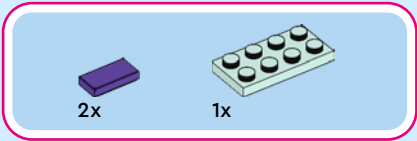

64

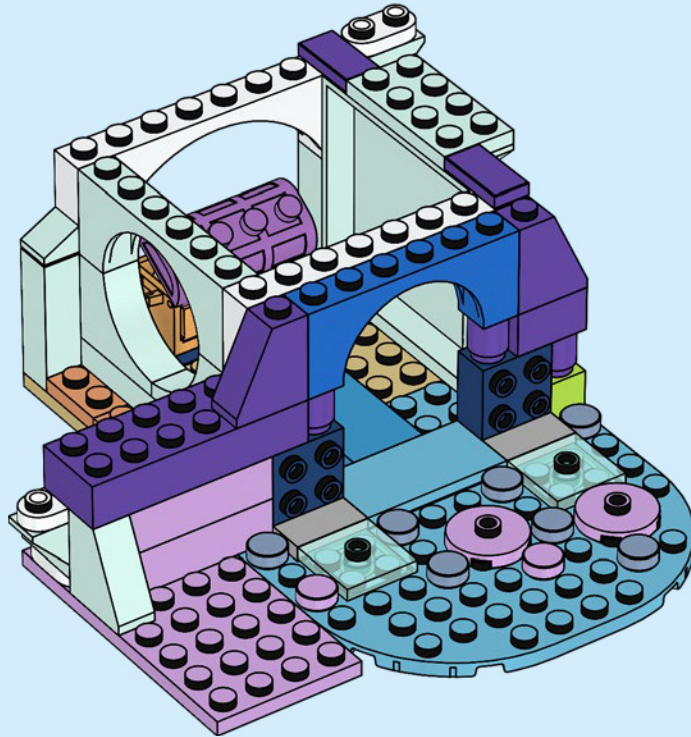

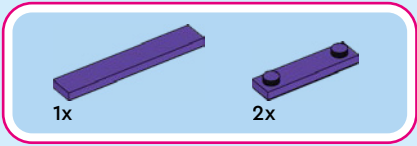

65

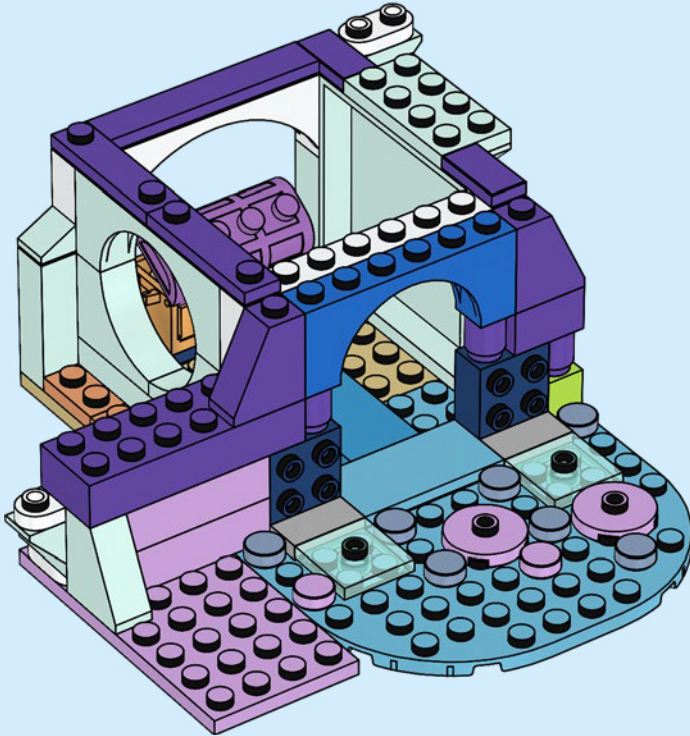



2x



2x

66

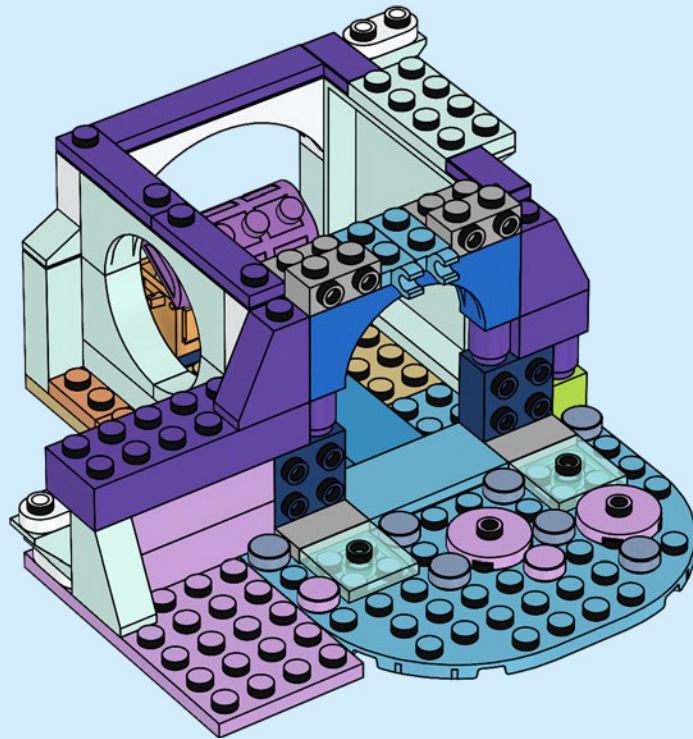

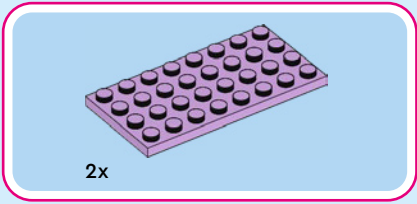

67

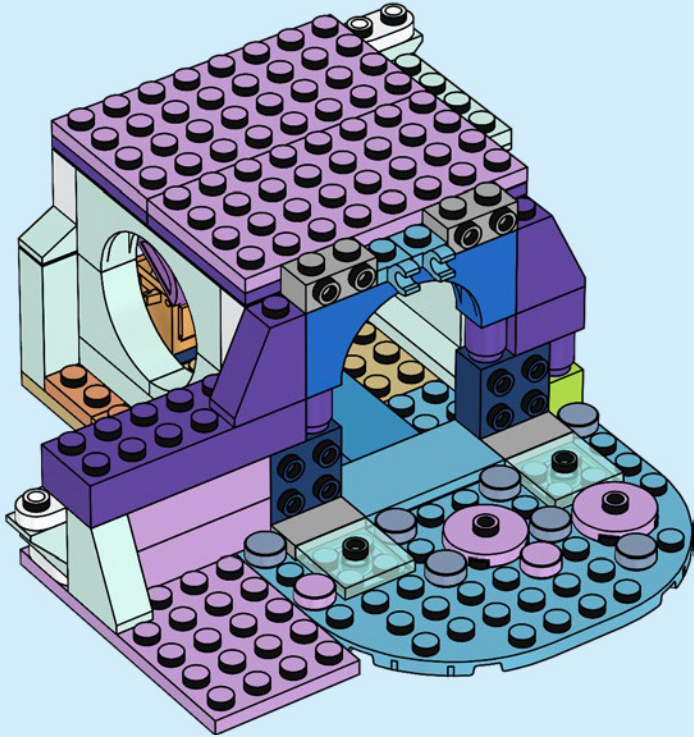

2x 1x



68

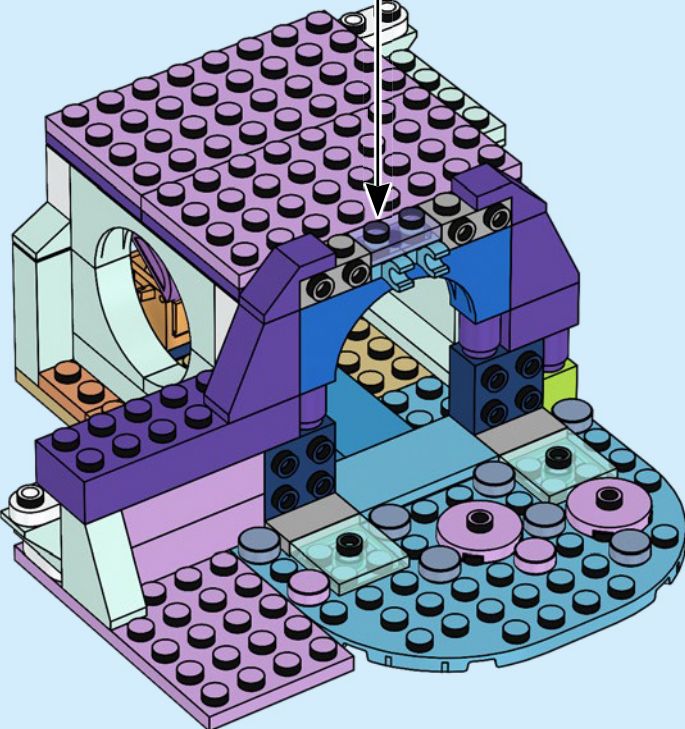

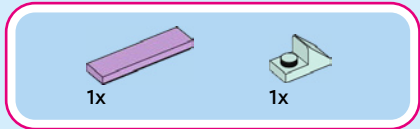

69

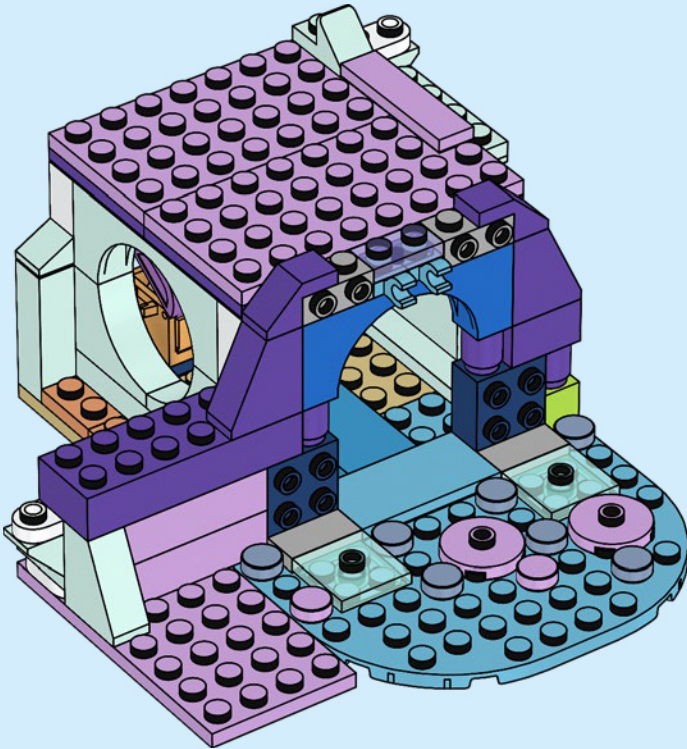



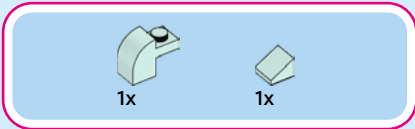

70

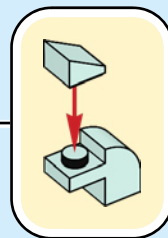
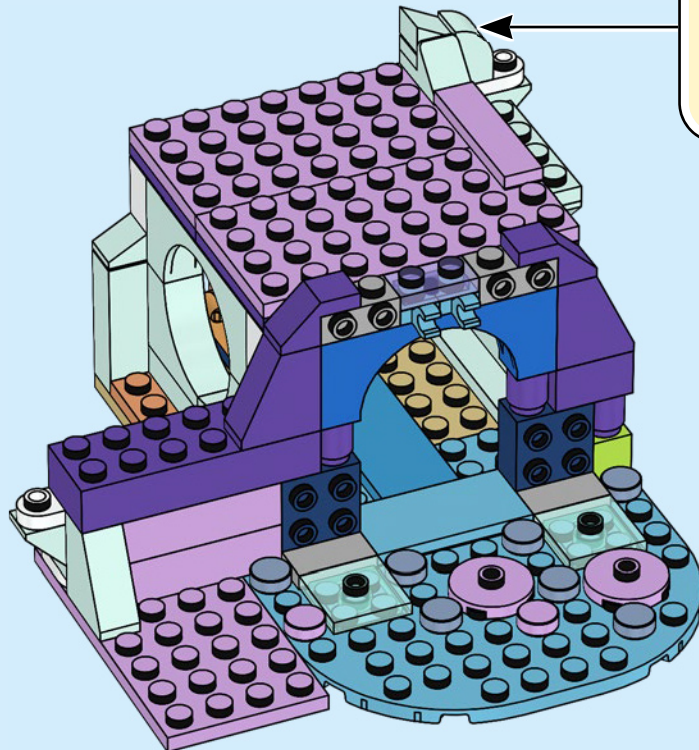



3x

71

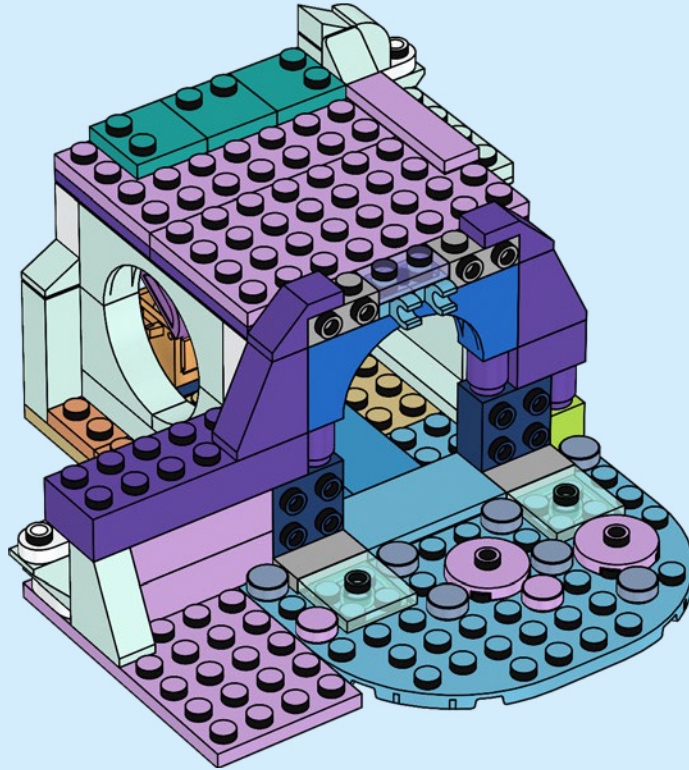



1x



1x

72

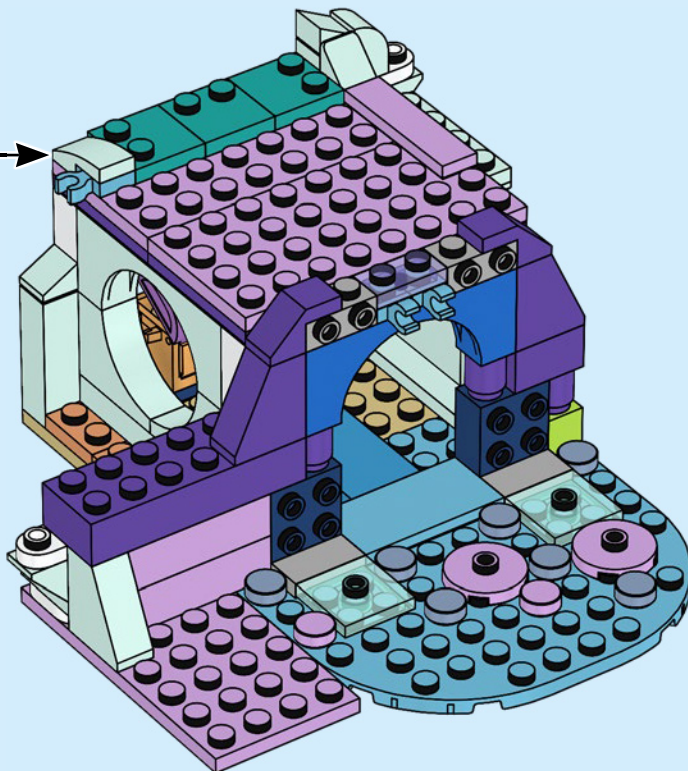
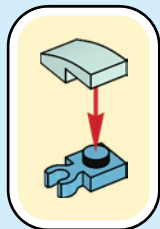



1x



2x

73

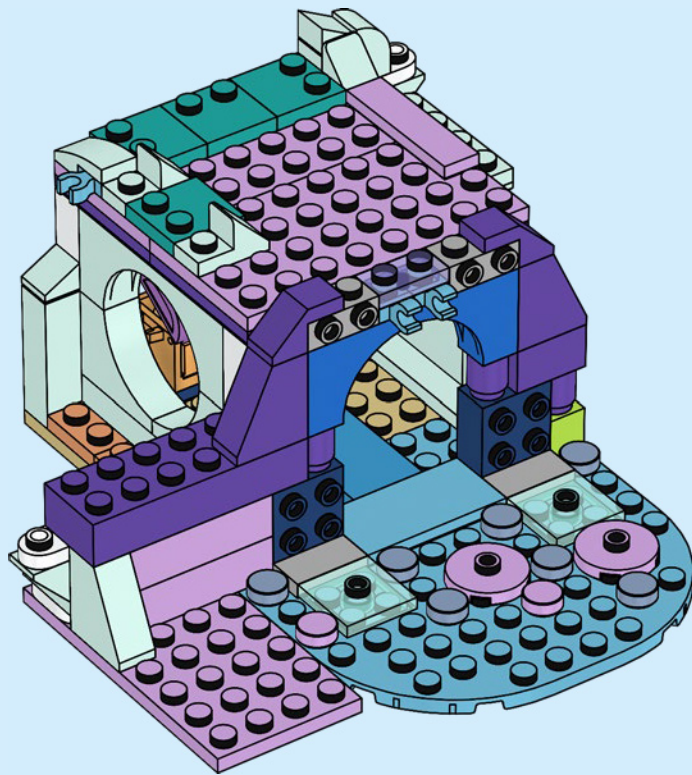

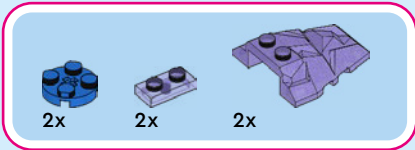

74

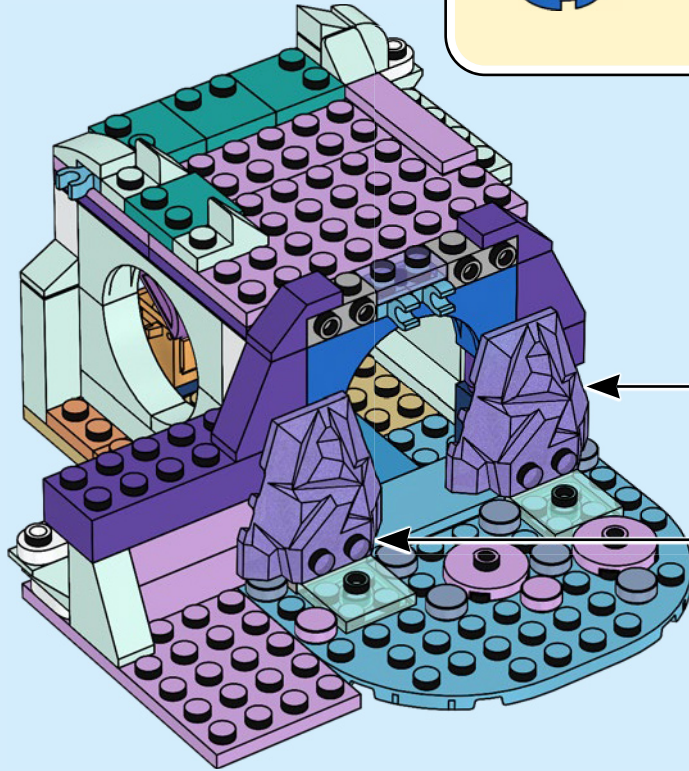
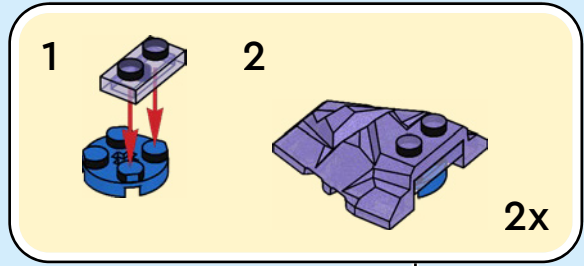



2x



2x

75

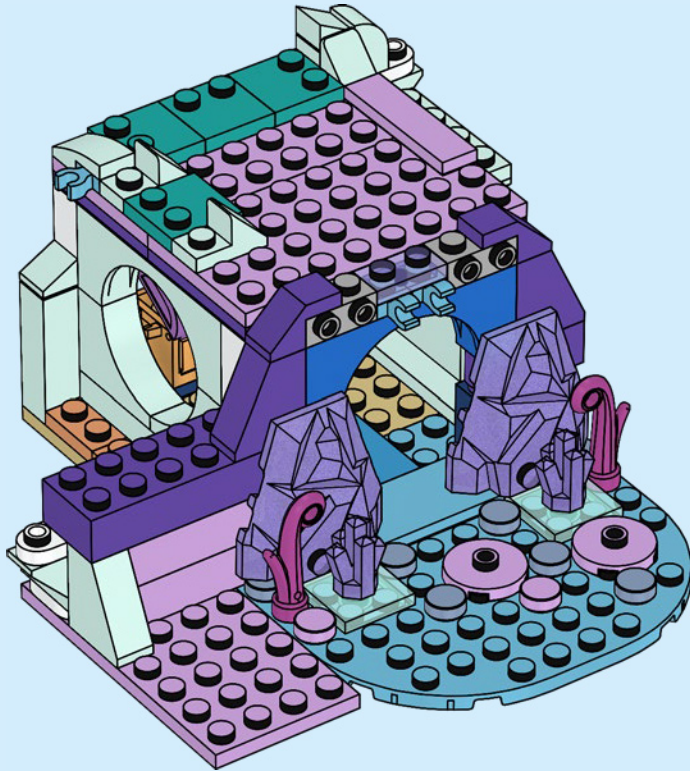

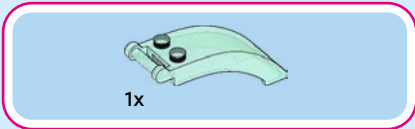

76

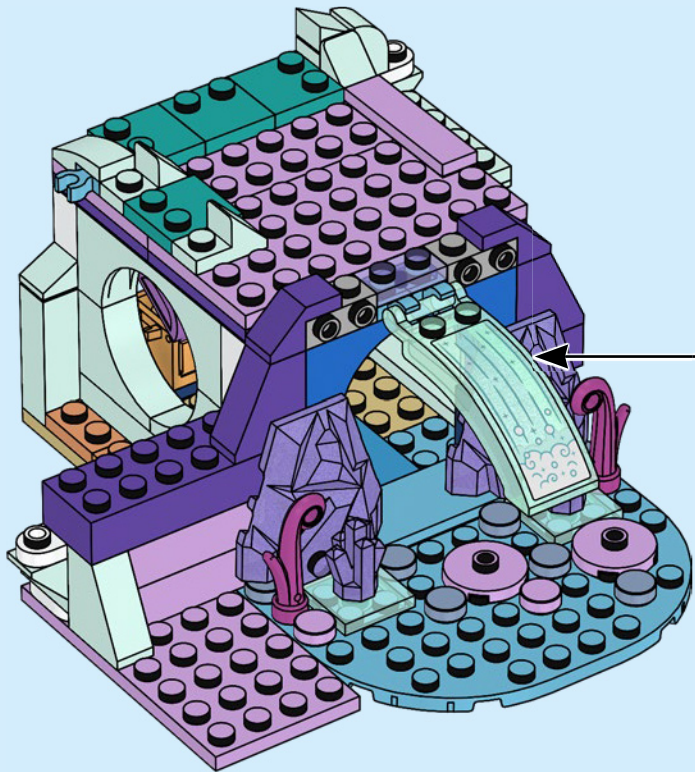
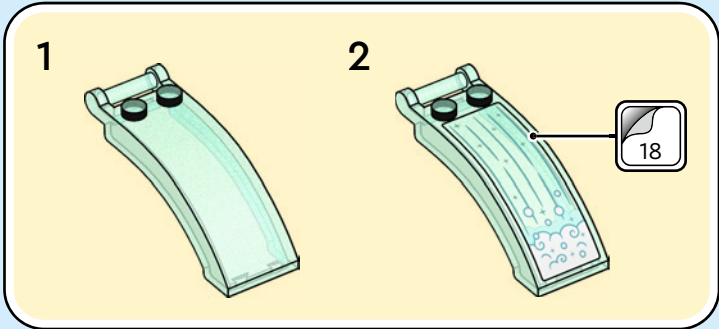

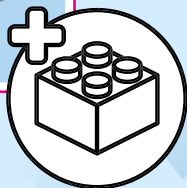
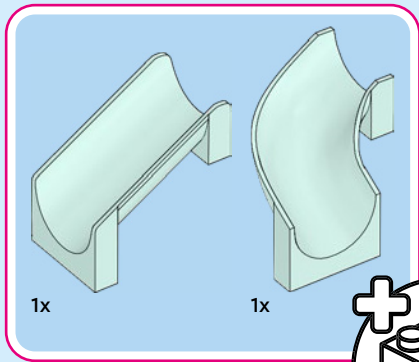

77

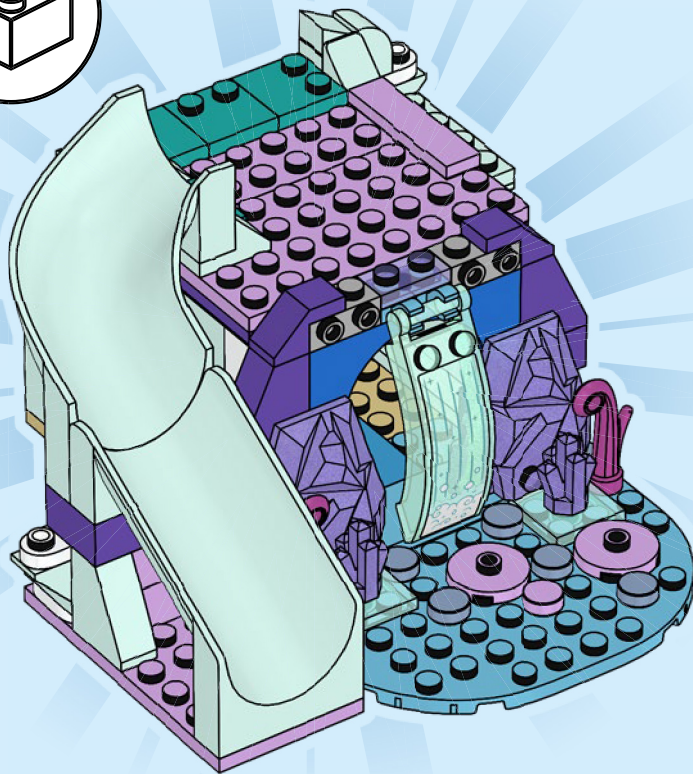



78

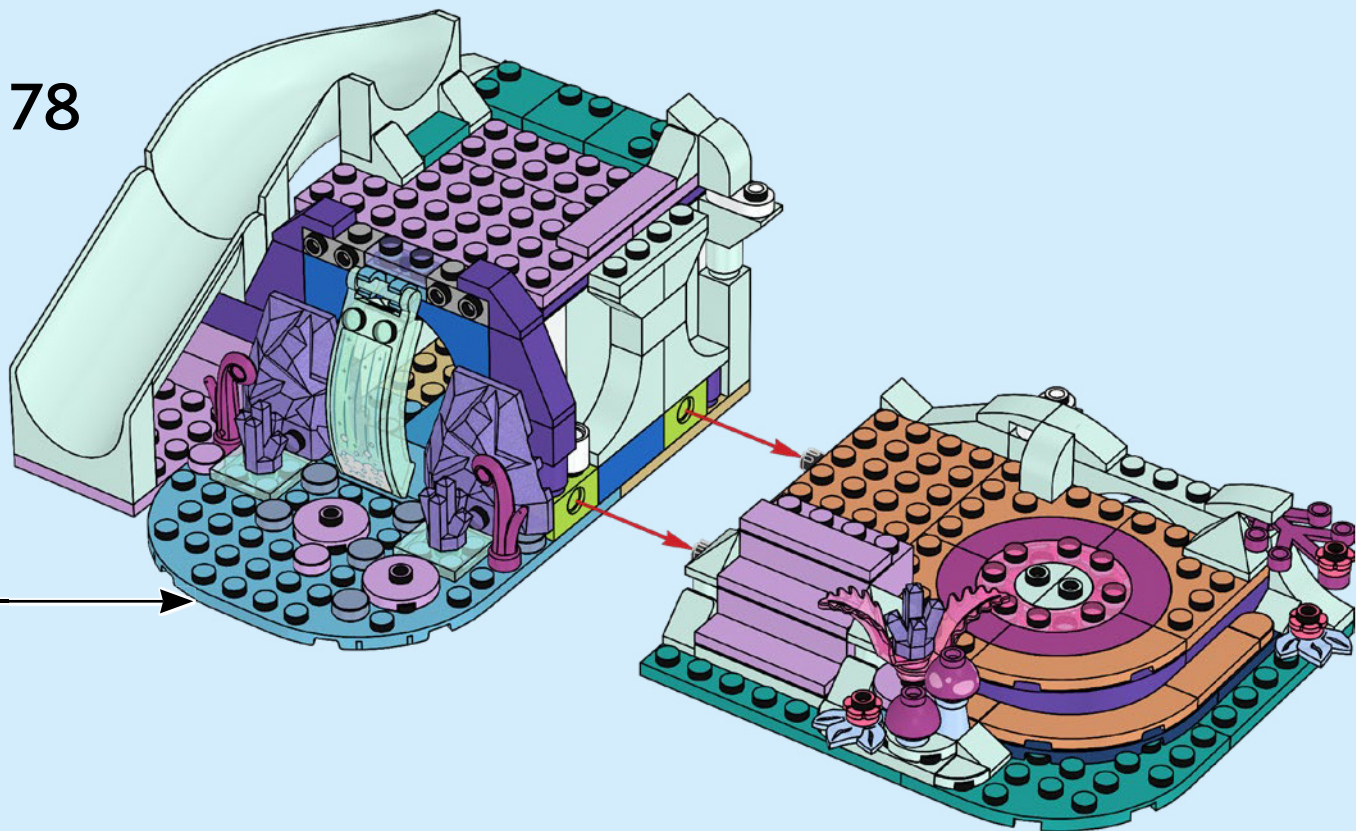



1x

79

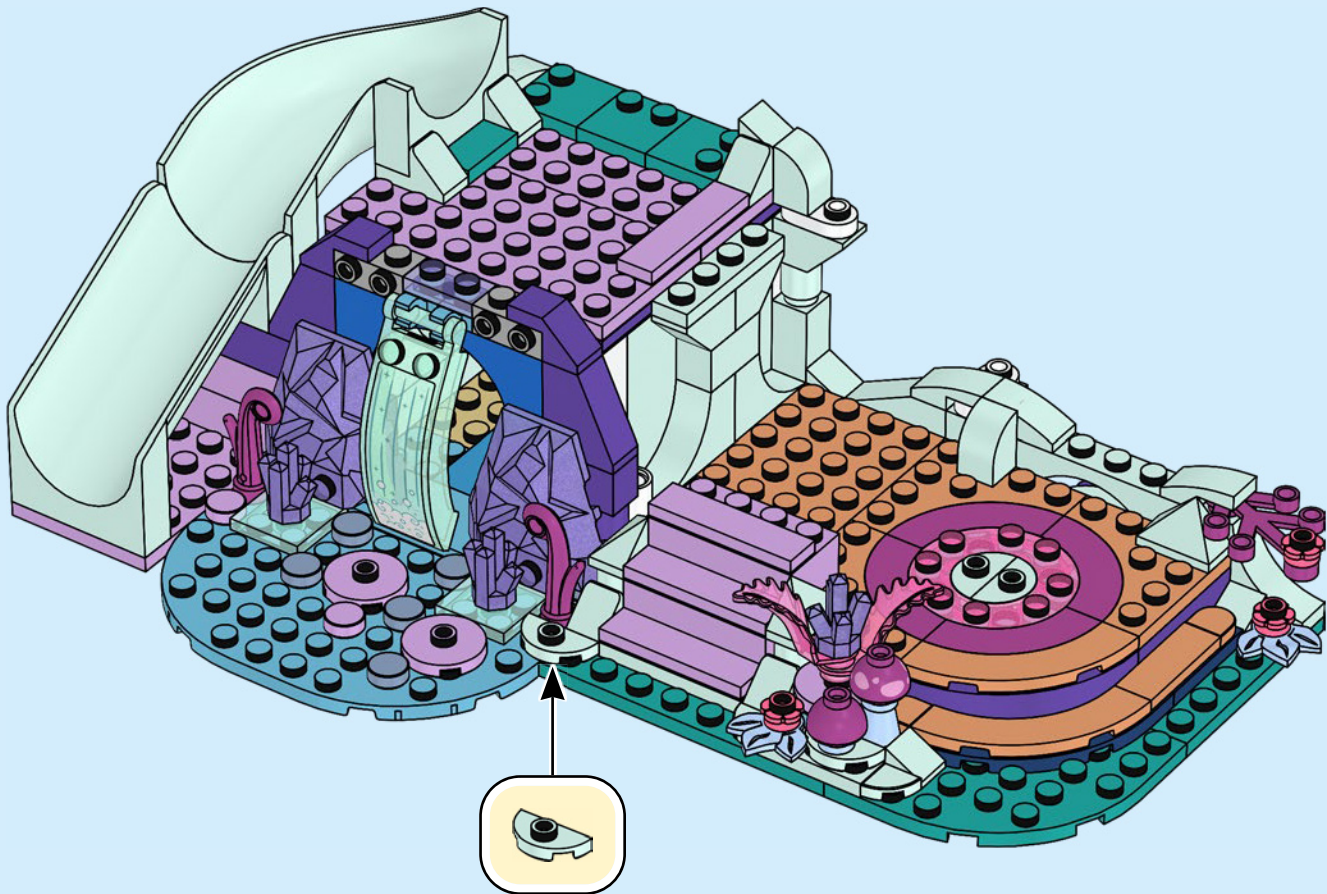



1x



1x

80

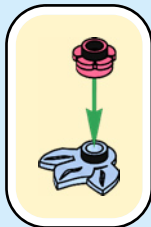
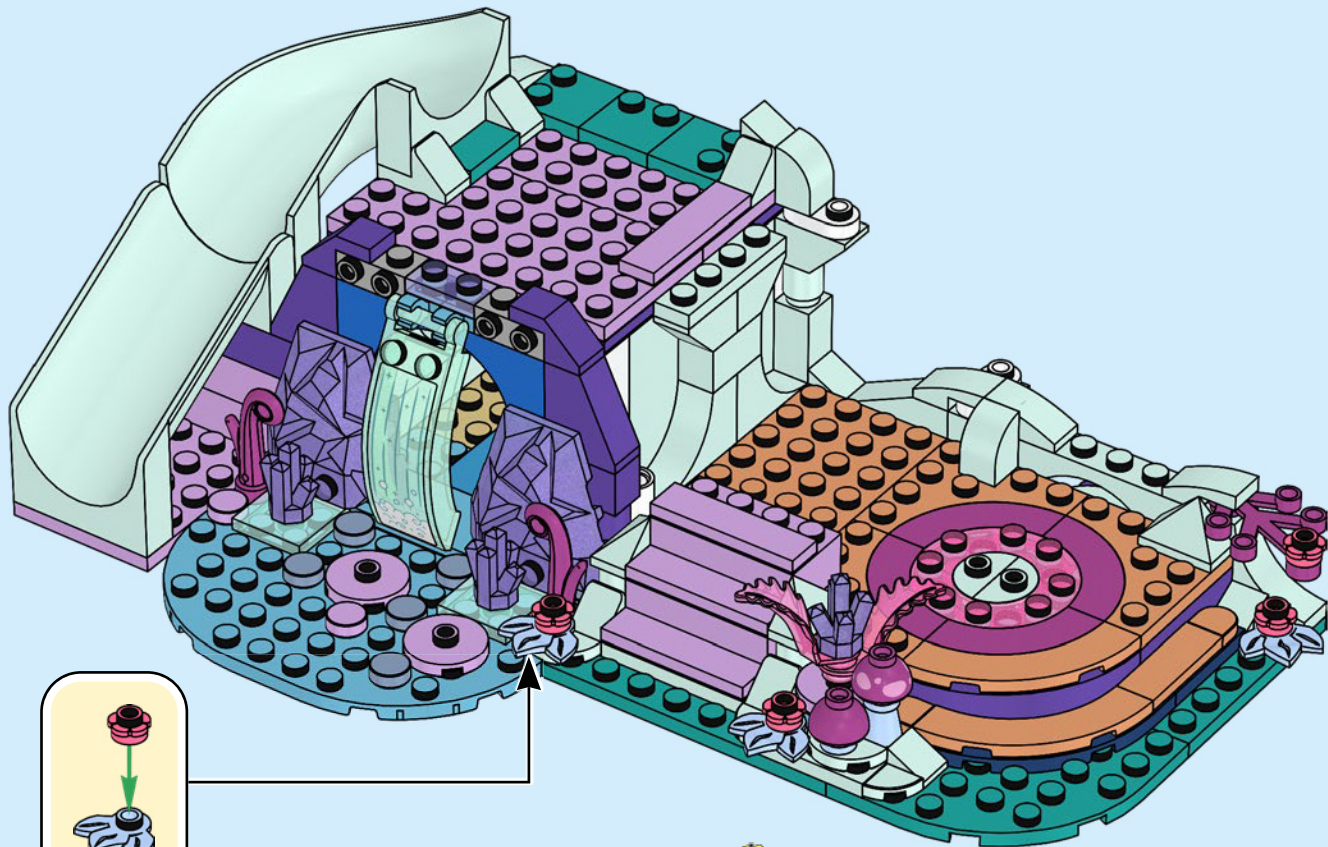



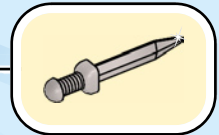
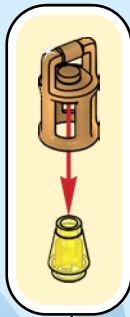
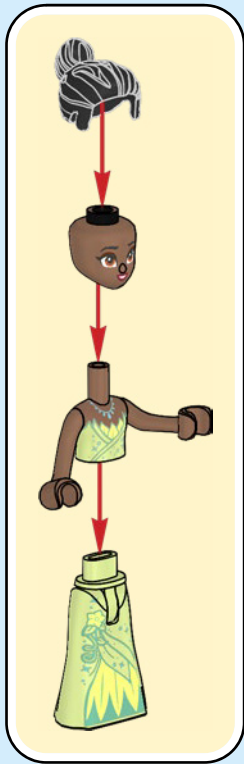

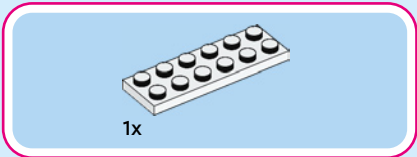
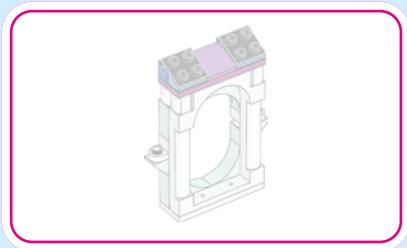

81

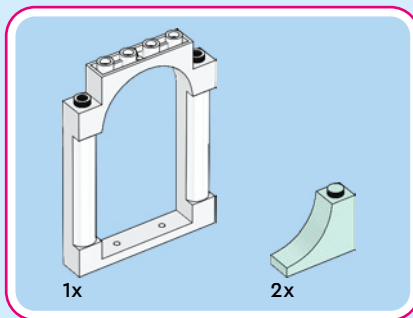

82

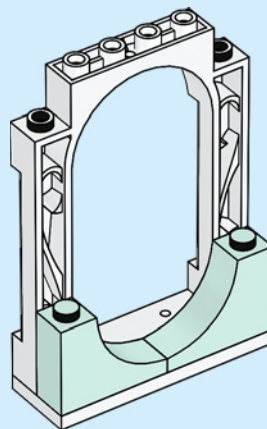



83

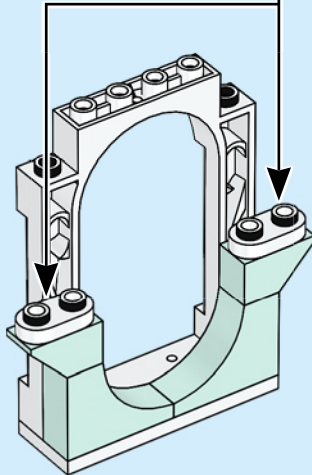
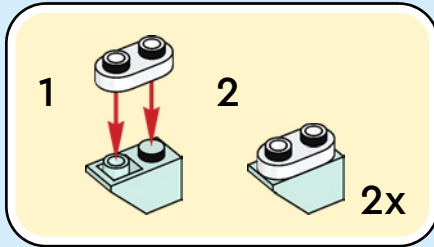

84

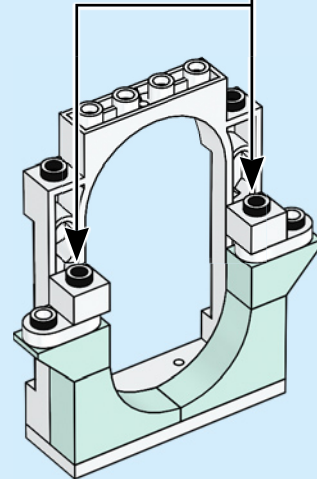
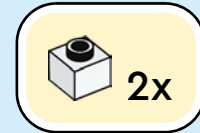

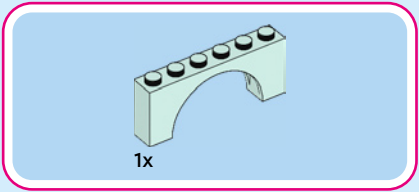

85

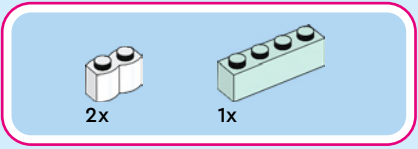
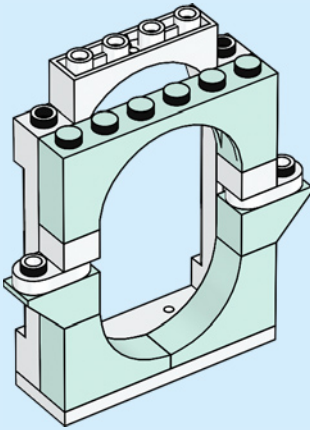

86

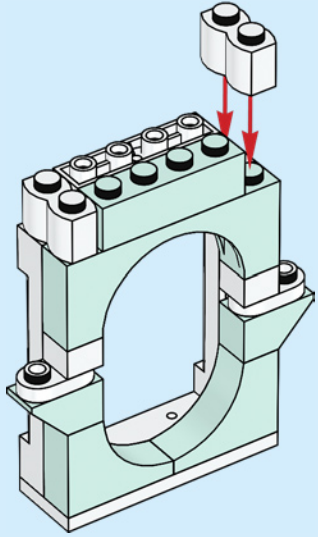



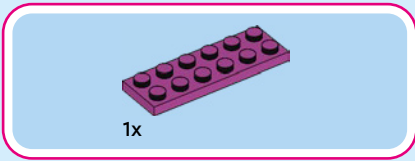

87

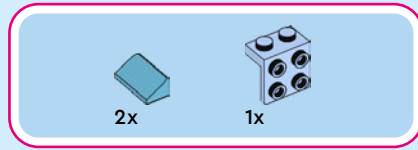
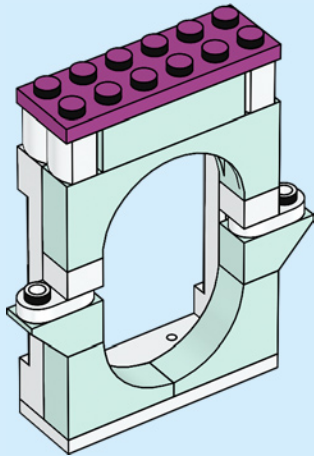

88

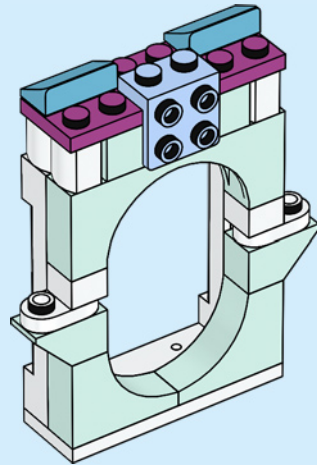



1x

89

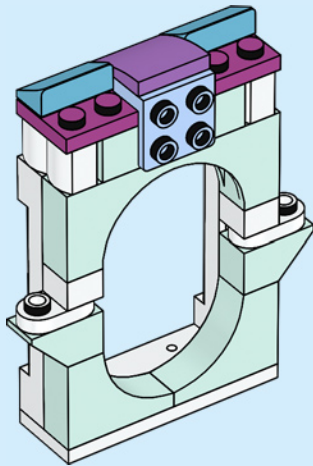

1x



1x

90

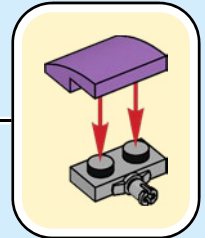
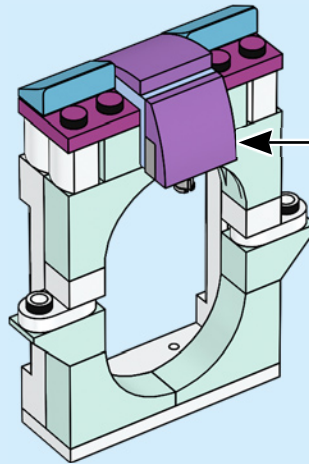



2x

91

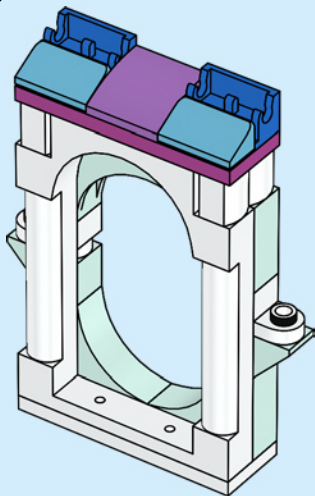

2x

92

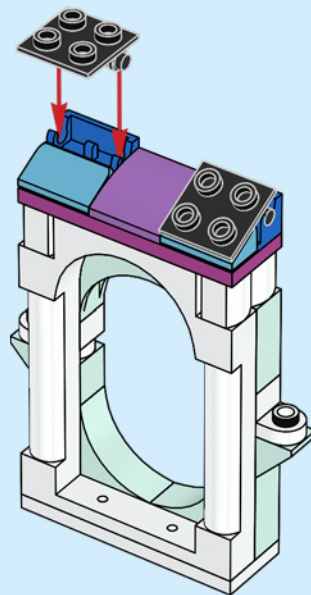

93

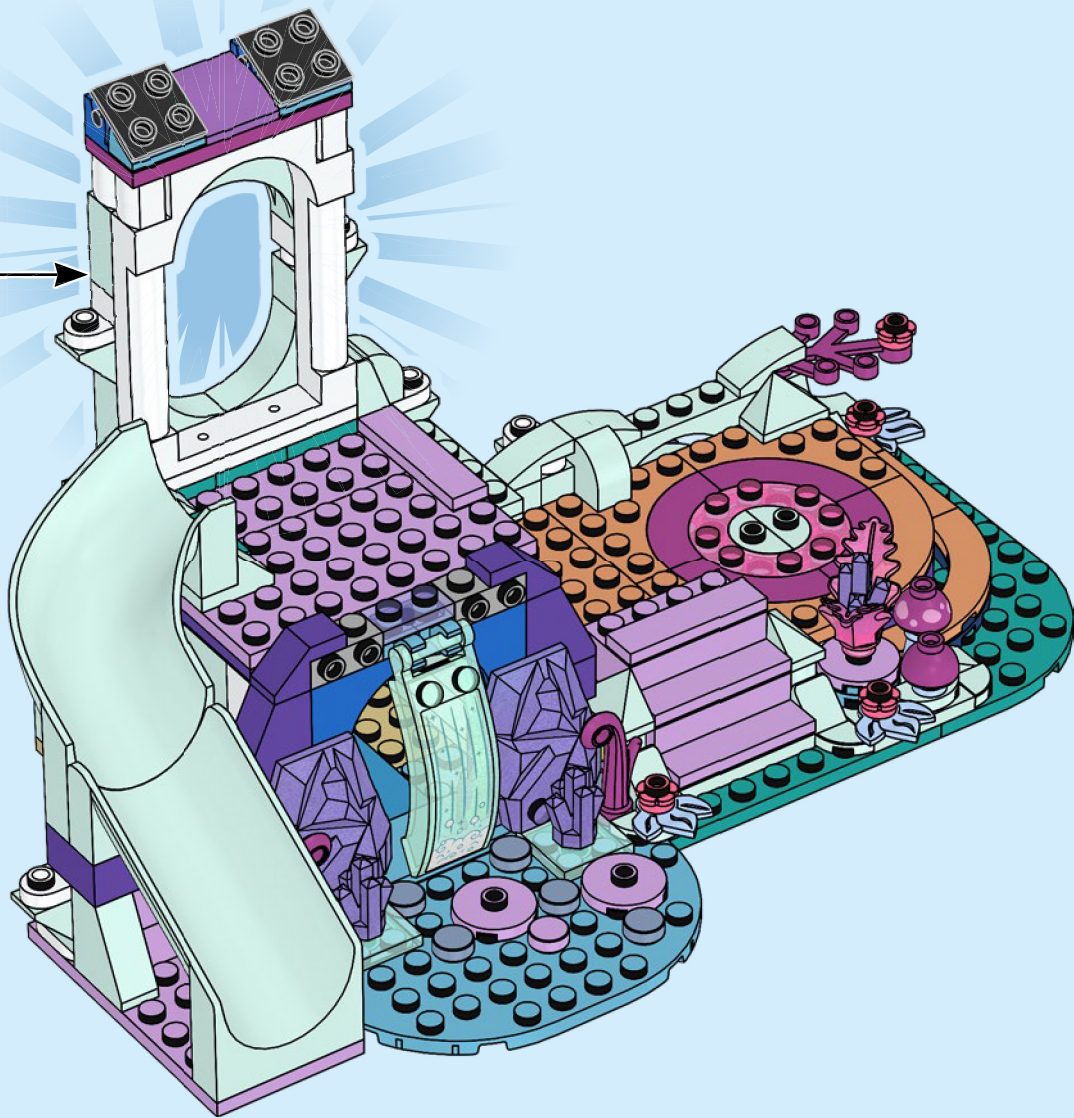

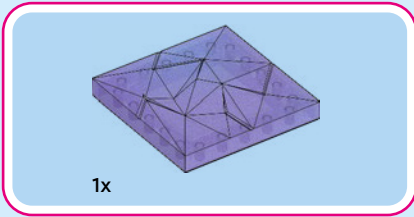

94

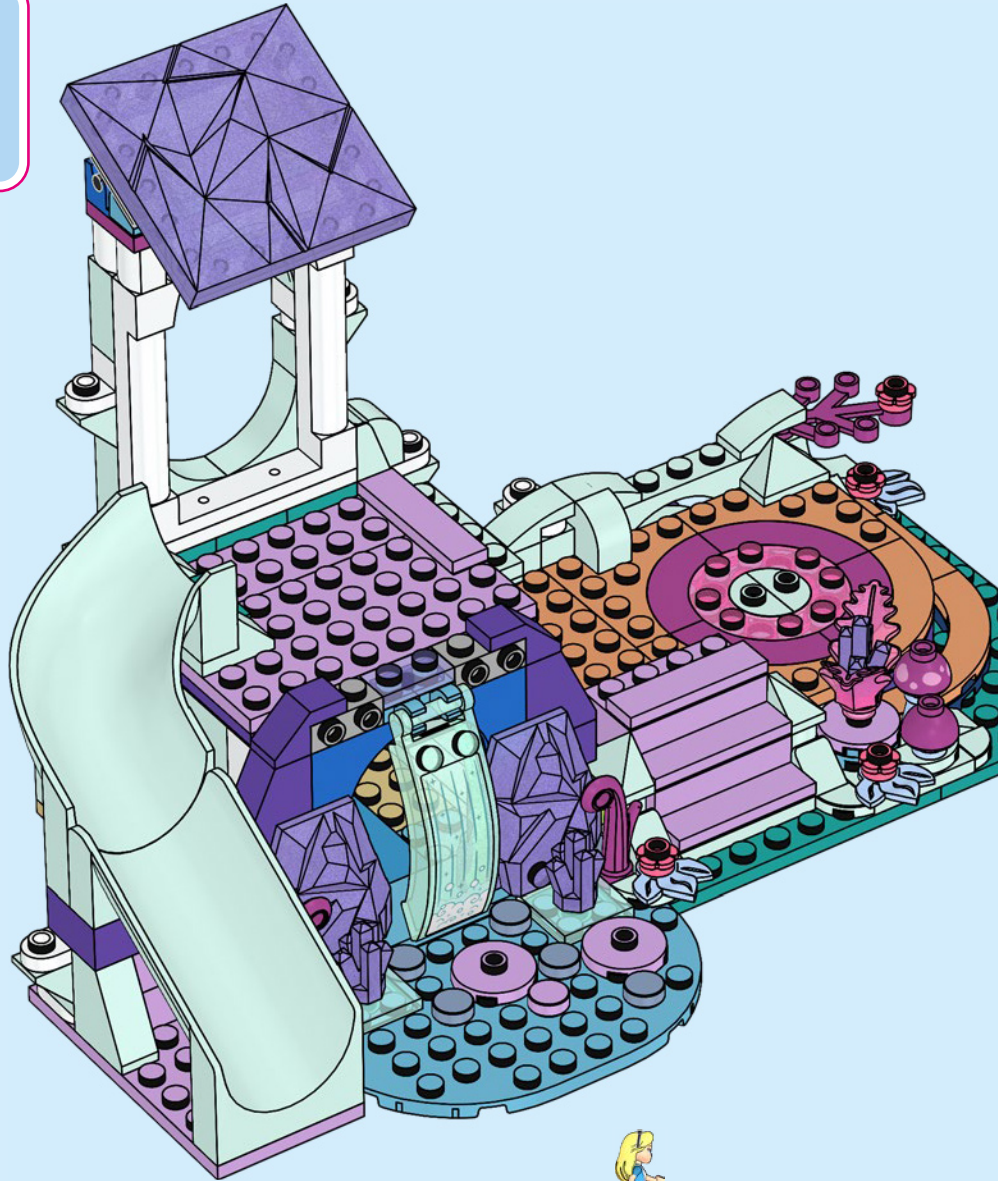

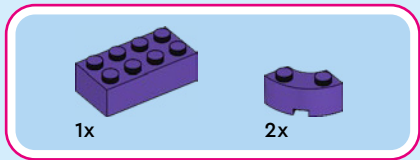

95

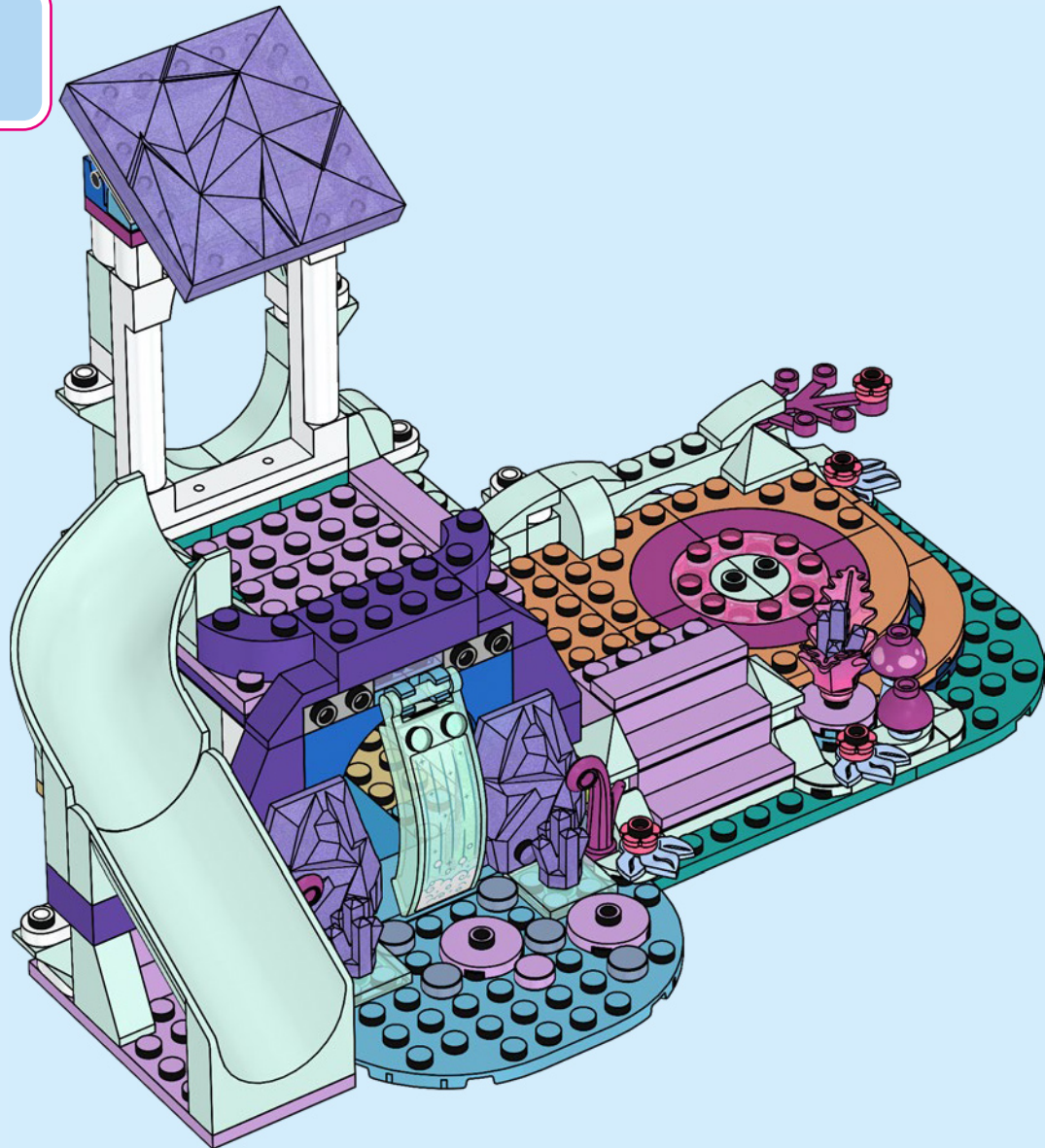

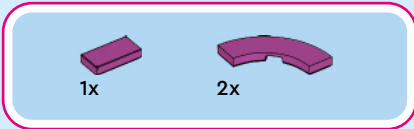

96

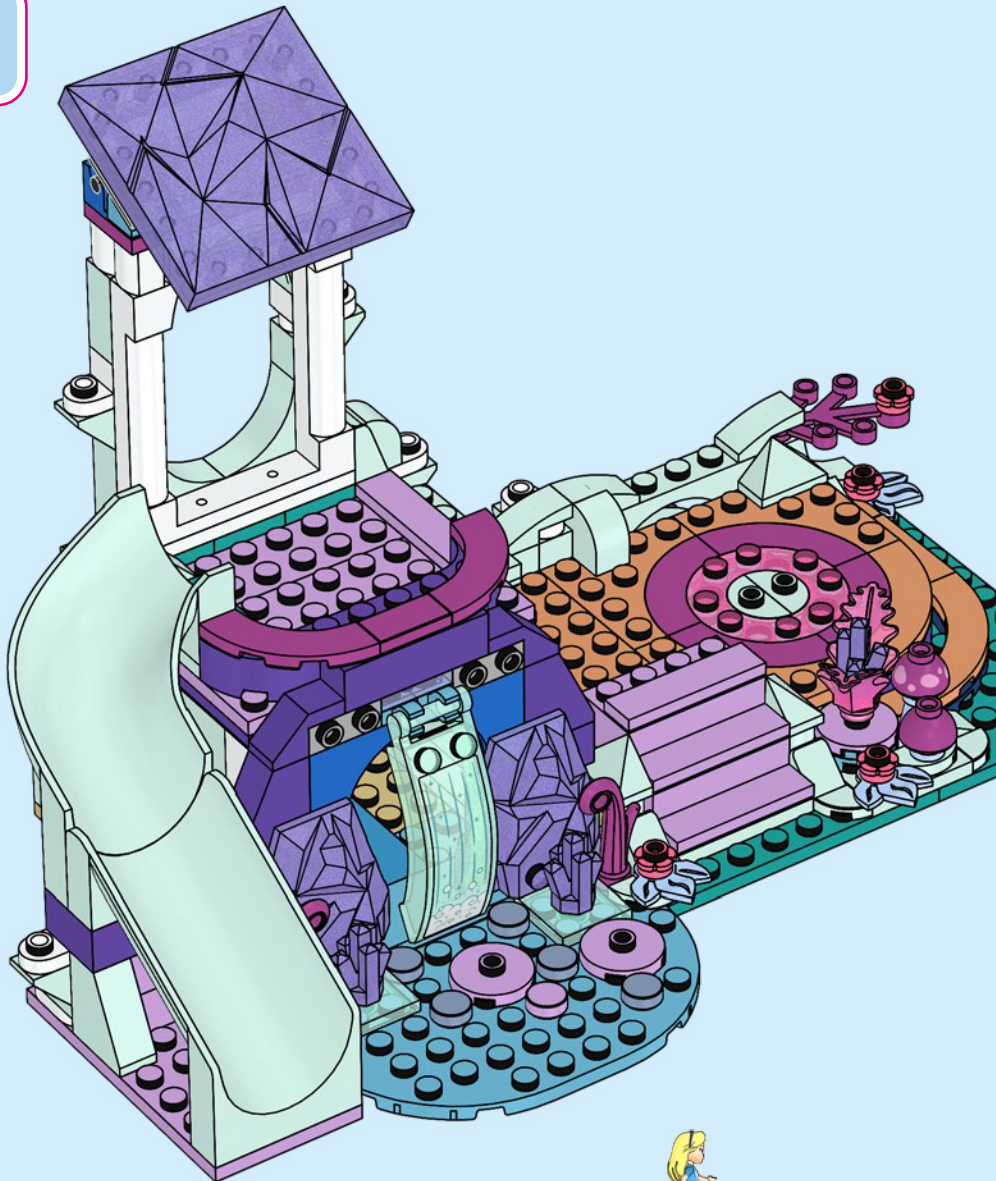



2x

97

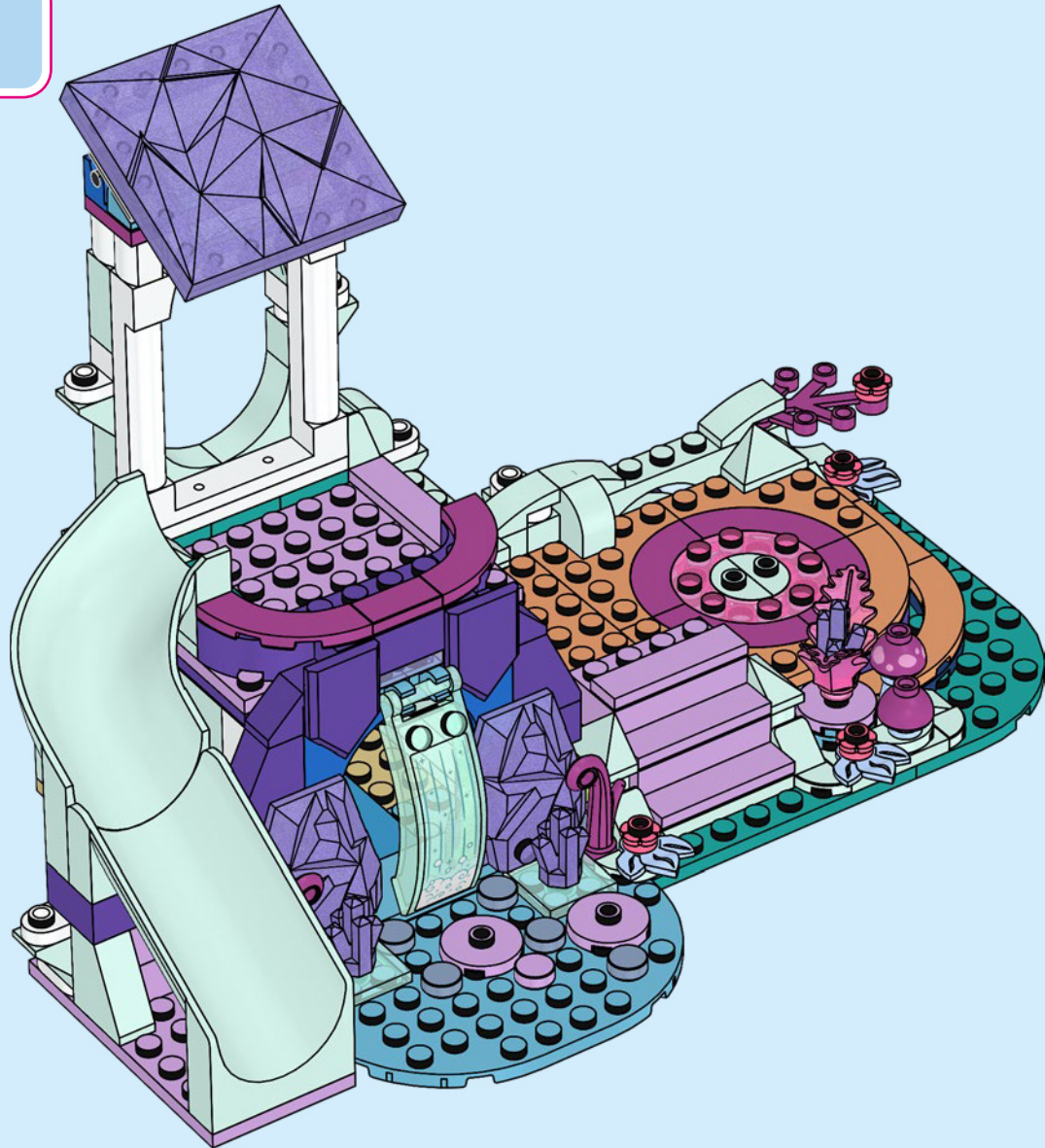



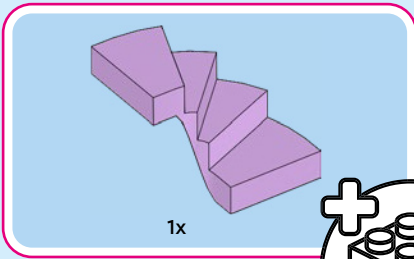

98

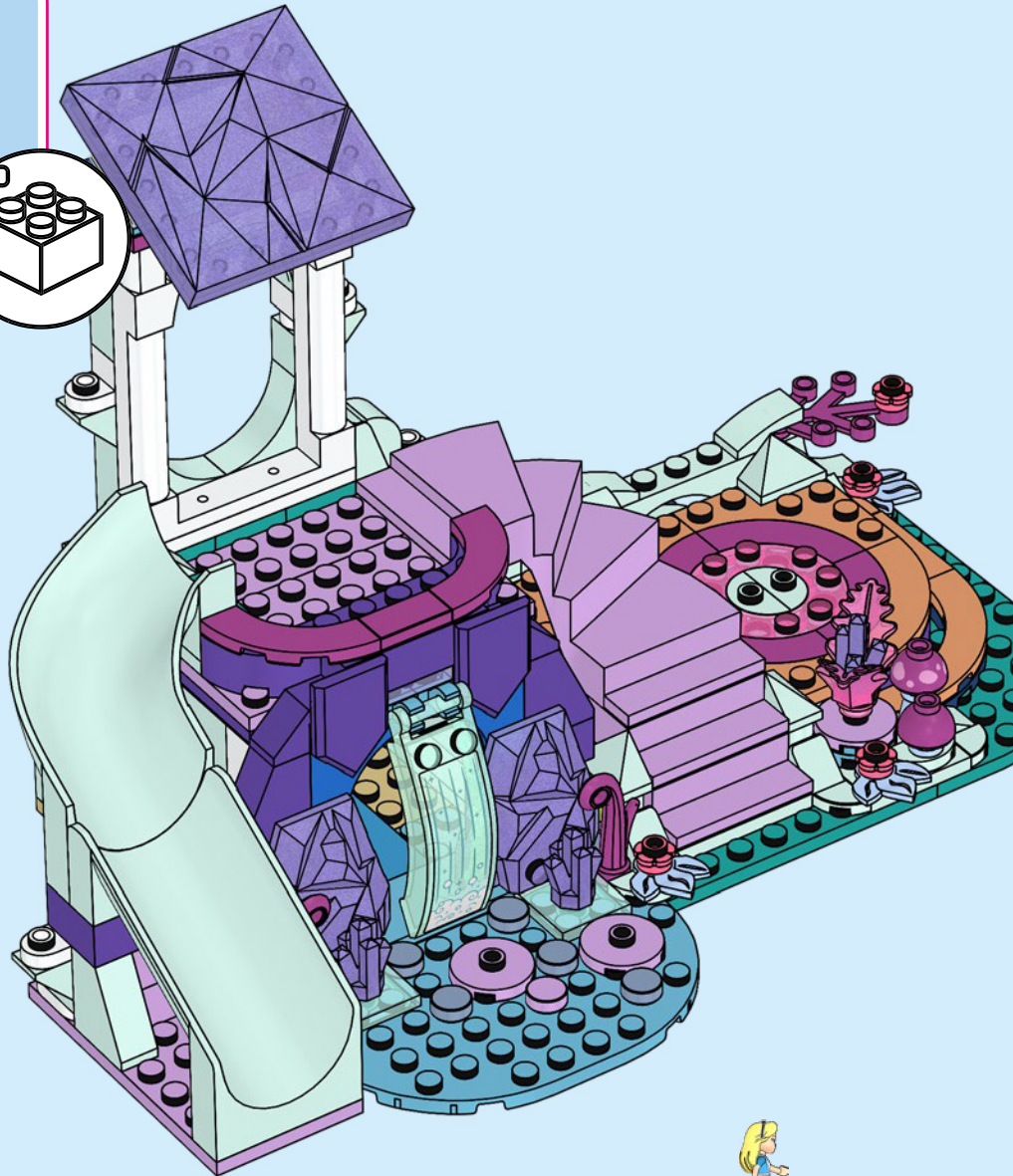



4x

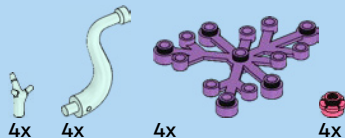

99

1

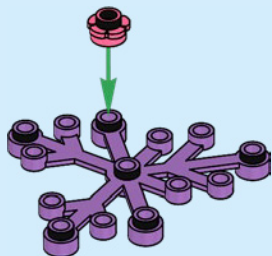

2

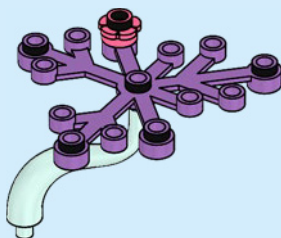

3

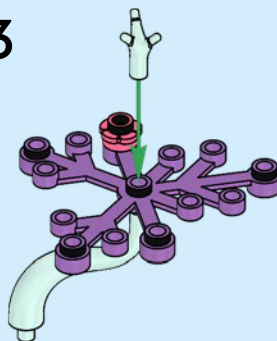

4x

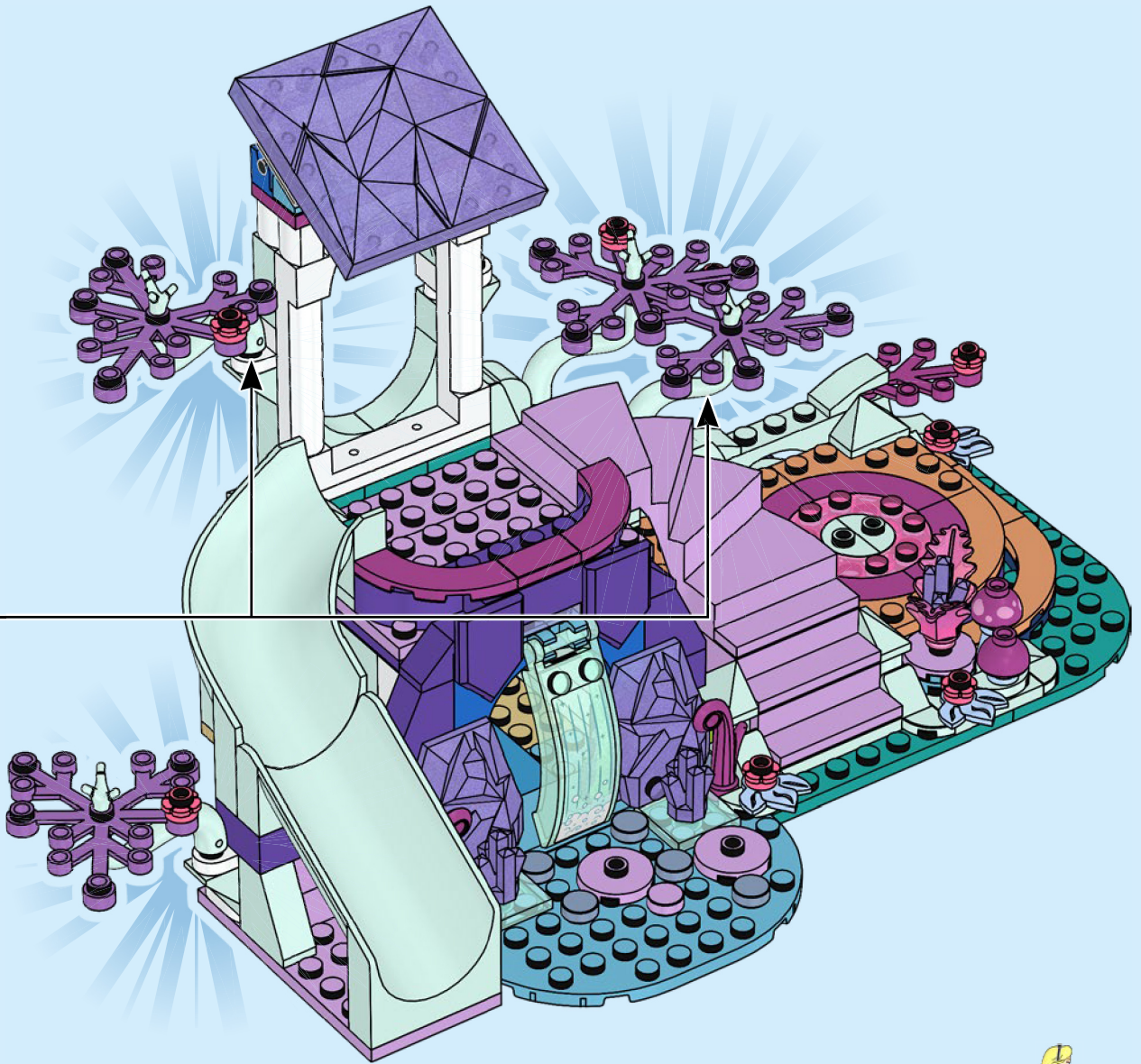

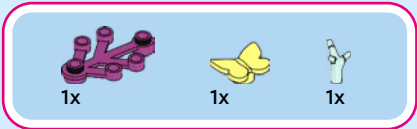

100

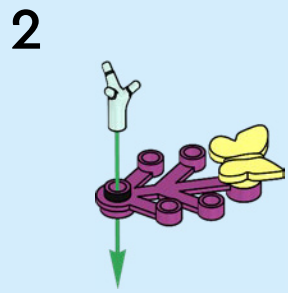
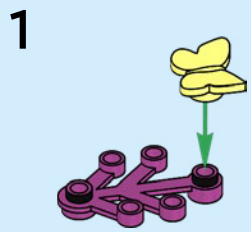

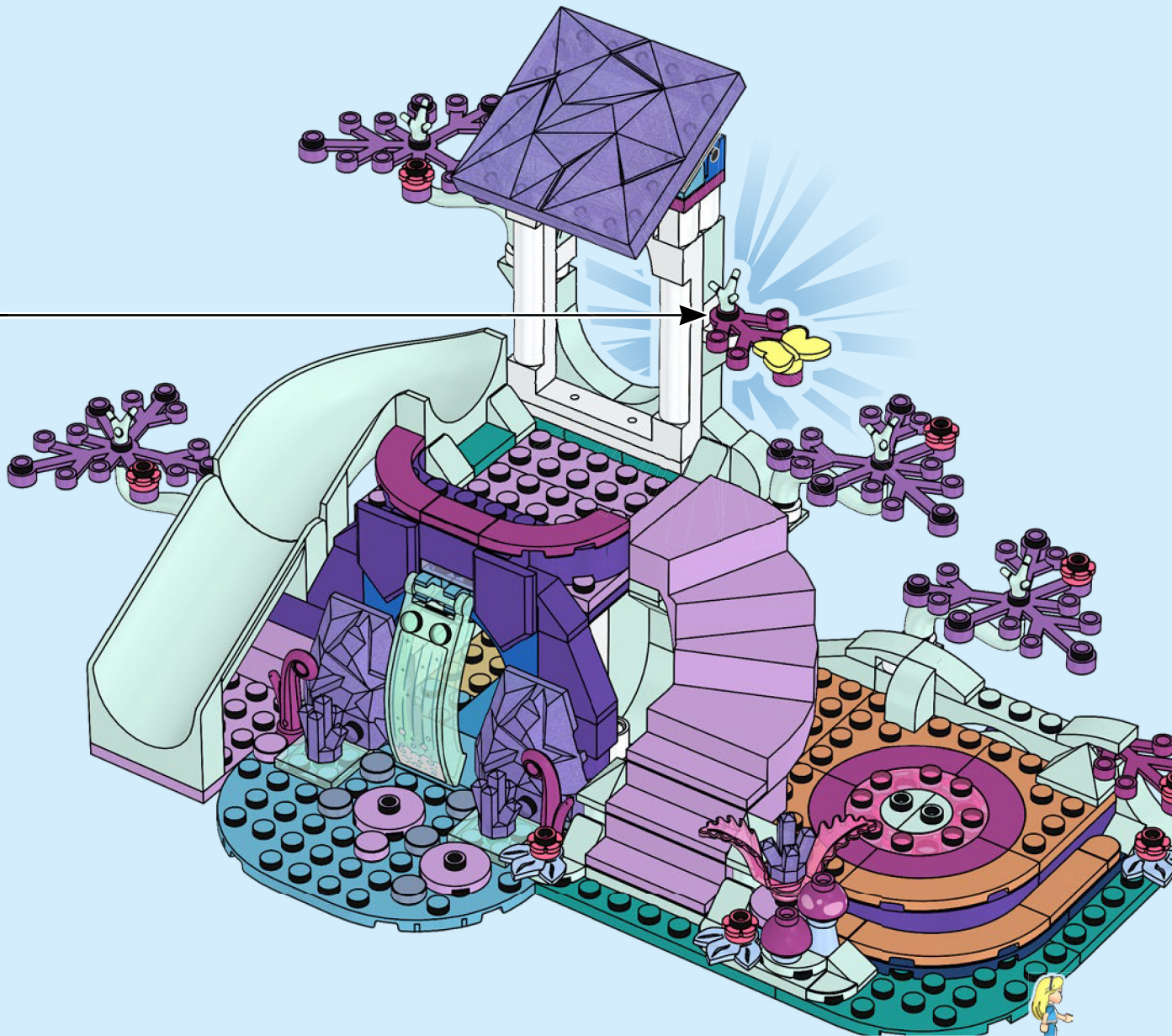

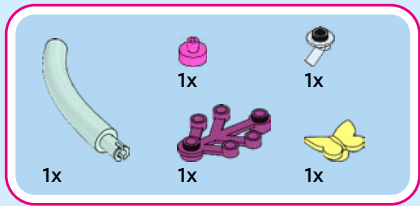

101

1

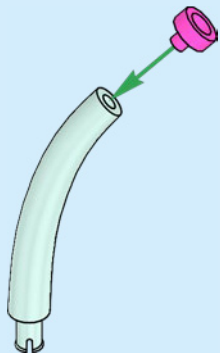

2

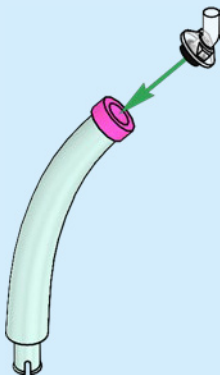

3

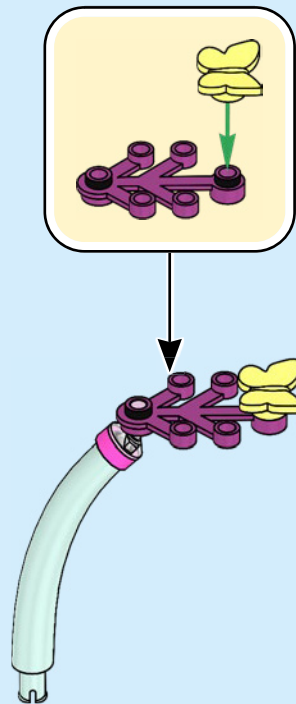

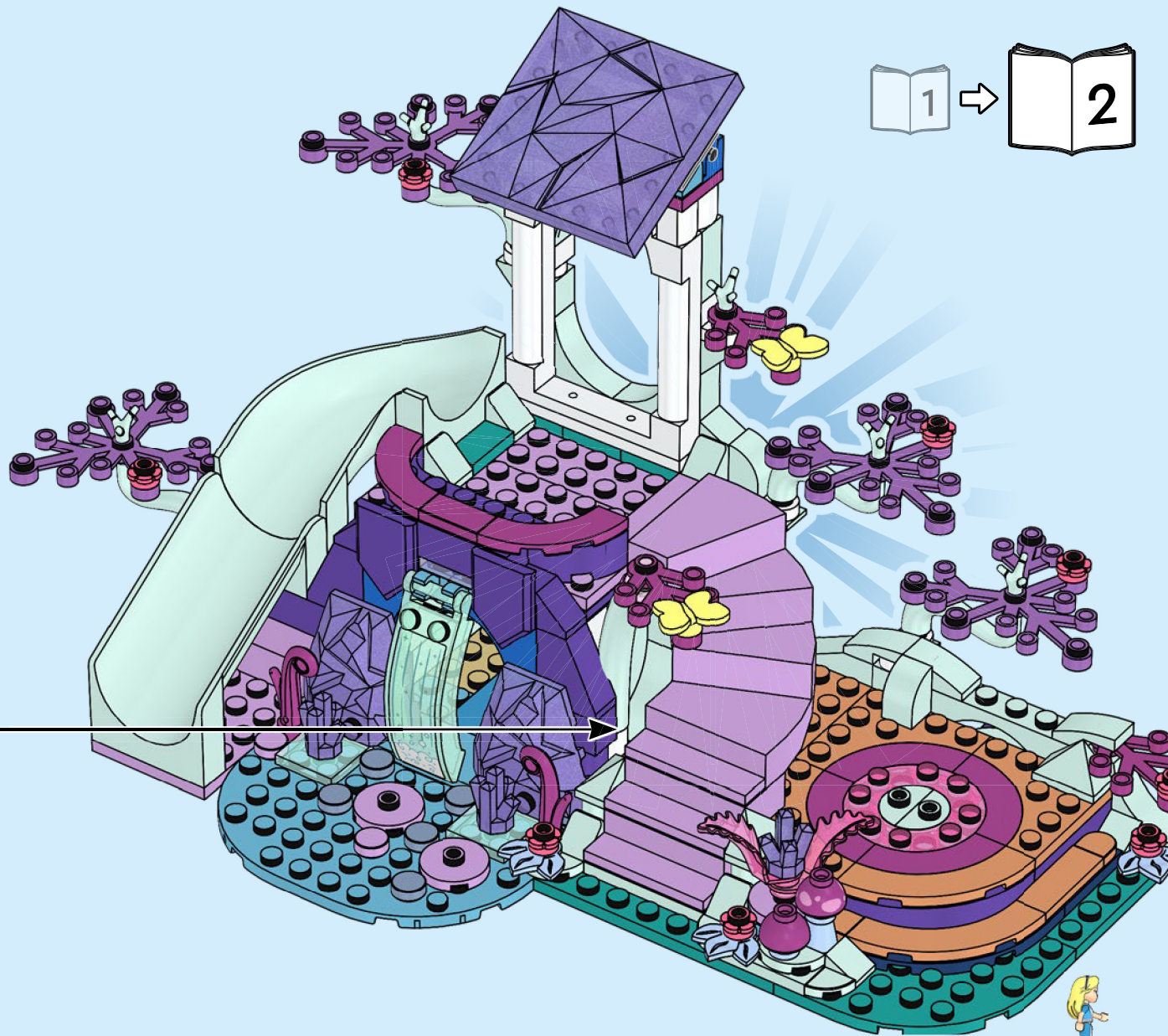
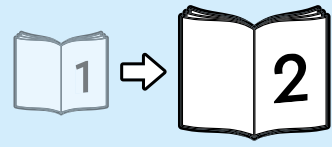

YOU COULD

WIN



Scan this QR code or go to  
**LEGO.COM/PRODUCTFEEDBACK** and give us  
your short feedback about this LEGO® set for a  
chance to win a cool LEGO prize.

Terms and Conditions apply\*

**EN: YOU COULD WIN.** Terms and Conditions apply\* **DE: Du könntest GEWINNEN.** Es gelten die Teilnahmebedingungen\* **FR: Tu pourrais GAGNER.** Des conditions s'appliquent\* **IT: Potresti VINCERE tu.** Termini e condizioni sono applicabili\* **ES: Puedes GANAR.** Aplican términos y condiciones\* **PT: Poderá GANHAR.** Aplicam-se termos e condições\* **ZH: 轻松获奖. 条款和条件适用\*** **PL: Szansa na WYGRANĄ.** Obowiązują warunki korzystania\* **CS: Máte šanci VYHRÁT.** Platí všeobecné smluvní podmínky\* **SK: Máte šancu VYHRAŤ.** Platia všeobecné zmluvné podmienky\* **HU: TE IS NYERHETSZ.** Felhasználási feltételek érvényesek\* **RO: Ai putea CÂȘTIGA.** Se aplică termeni și condiții\* **BG: Можете да СПЕЧЕЛИТЕ.** Има определени правила и условия\* **LV: Tu vari LAIMĒT.** Ir spēkā noteikumi un nosacījumi.\* **ET: Sul on võimalus VÕITA.** Kehtivad tingimused\* **LT: Jūs galite LAIMĖTI.** Taikomos sąlygos\*

\*[LEGO.com/productfeedback-terms](https://www.lego.com/productfeedback-terms)

LEGO and the LEGO logo are trademarks of the LEGO Group. ©2023 The LEGO Group. ©Disney

6468543