



# CLASSIC

11028





[LEGO.com/sustainable-packaging](https://LEGO.com/sustainable-packaging)

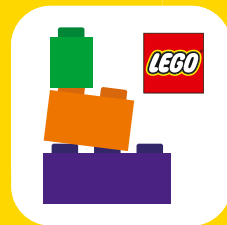

# BUILDER



Apple and the Apple logo are trademarks of Apple Inc., registered in the U.S. and other countries and regions. App Store is a service mark of Apple Inc. Google Play and the Google Play logo are trademarks of Google LLC. Tencent and the Tencent logo are trademarks of Tencent Inc.

**EN** Ask parents' permission before going online | **DE** Eltern um Erlaubnis bitten, bevor du online gehst | **FR** Demande l'autorisation d'un parent avant d'aller en ligne | **IT** Chiedi il permesso ai tuoi genitori prima di andare online | **ES** Pídeles permiso a tus papás antes de conectarte a Internet | **PT** Pede autorização aos pais antes de acederes online | **JA** オンラインになる前に ほか者の方のきょかをもらおう | **ZH** 上网前应先征得父母的同意 | **KO** 온라인 접속 전에 보호자 동의가 필요합니다 | **RU** Спроси разрешения у родителей, прежде чем заходить в интернет | **PL** Poproś rodziców o zgodę, zanim wejdziesz do Internetu | **CS** Než půjdeš na internet, požádej rodiče o svolení | **SK** Skôr než pôjdeš na internet, vypýtaj si povolenie od rodičov | **HU** Kérj szülői engedélyt, mielőtt online csatlakoznál! | **RO** Cere permisiunea părinților înainte de a te conecta online | **BG** Поискайте разрешение от родител, преди да влезете онлайн | **LV** Pirms došanās tiešsaistē palūdz atļauju vecākiem | **ET** Enne Interneti kasutamist küsi vanematelt luba | **LT** Prieš prisijungdami prie interneto, atsklauskite tėvų

Q [LEGO.com/devicecheck](https://www.lego.com/devicecheck)

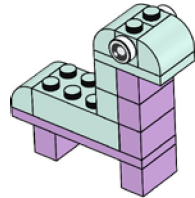
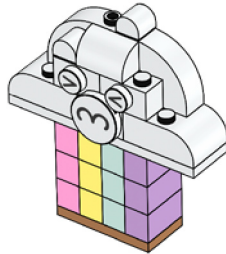
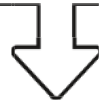
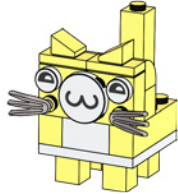
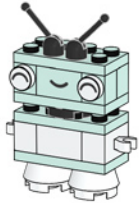
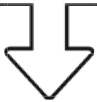



1



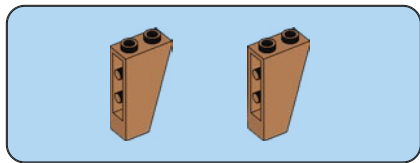

2

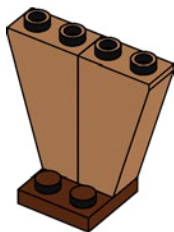

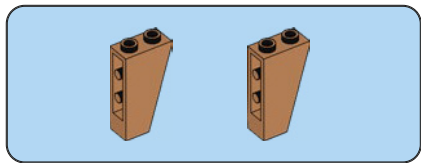

3



4

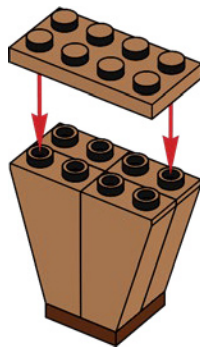

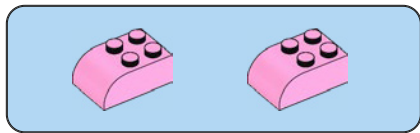

5





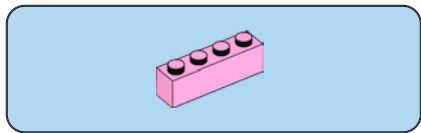

6

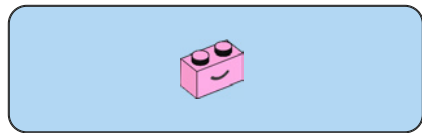
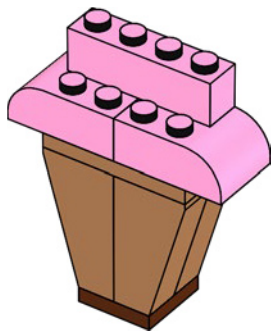

7

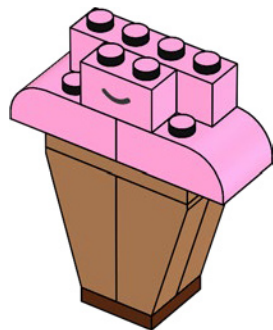

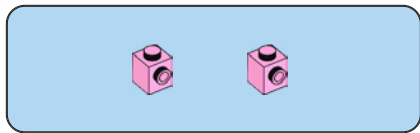

8

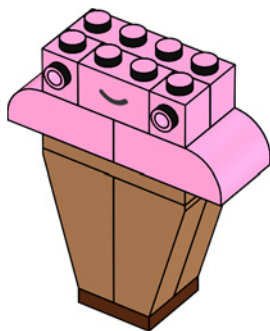



9

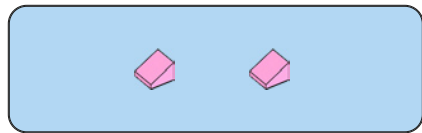

10



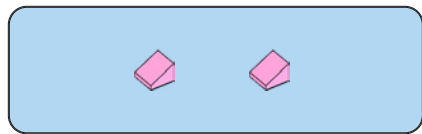

11

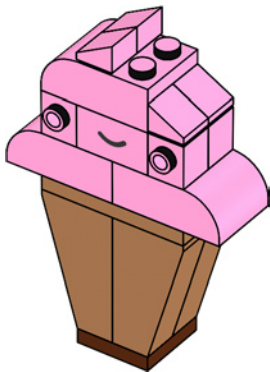

12

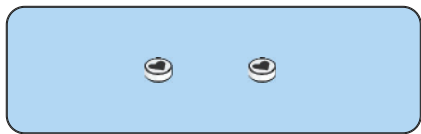

12

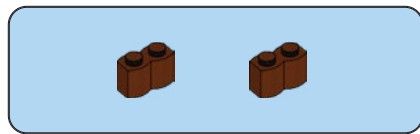

13

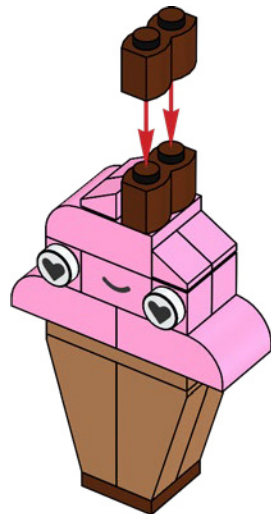

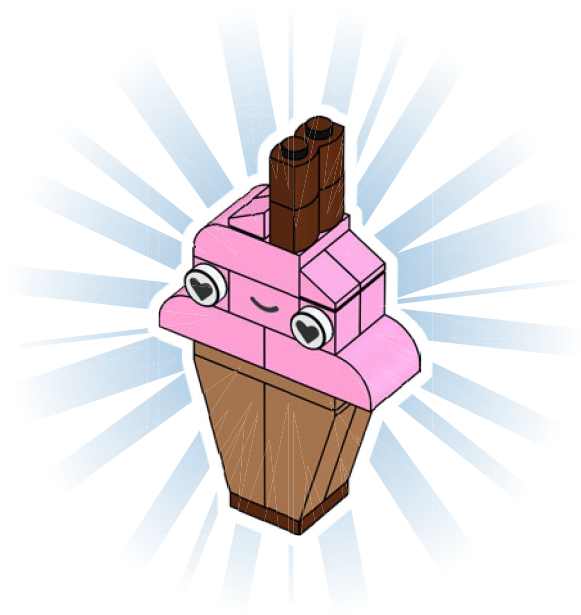

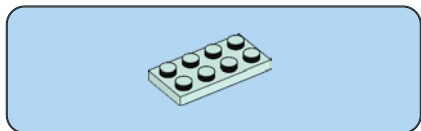
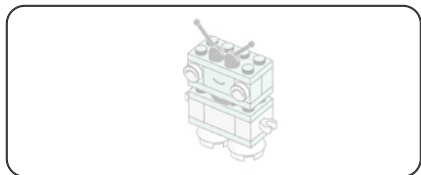

1

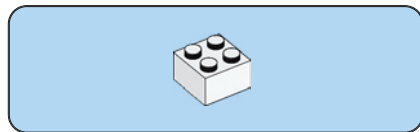
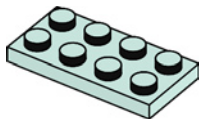

2

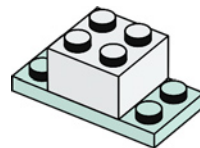

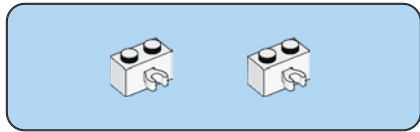

3

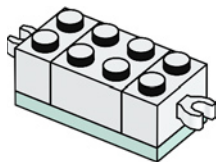



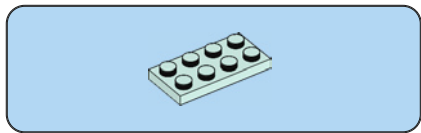

4

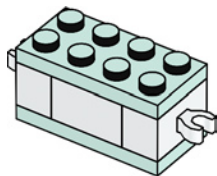

5

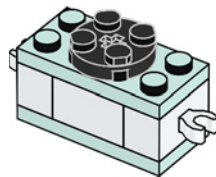

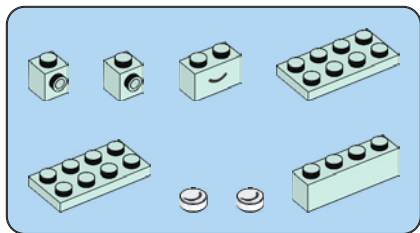

6

1

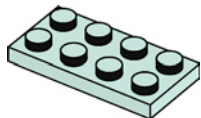

2

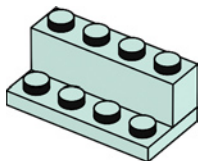

3

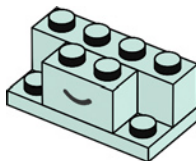

4

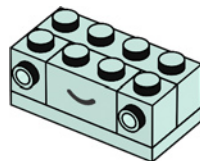

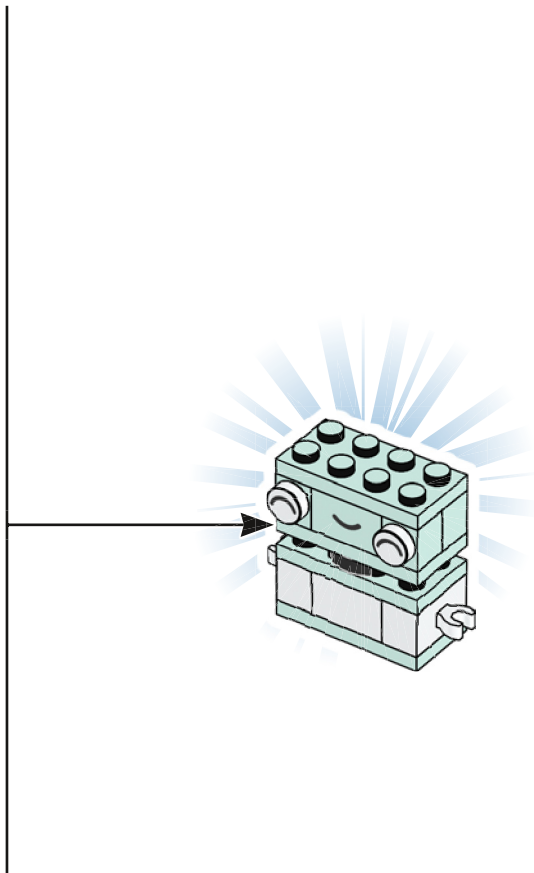
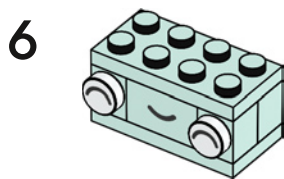
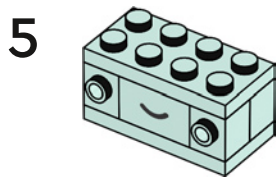

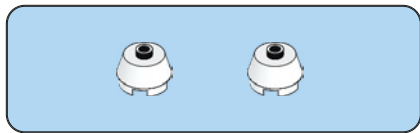

7

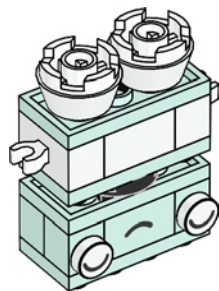

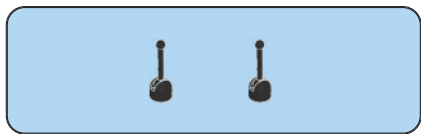

8

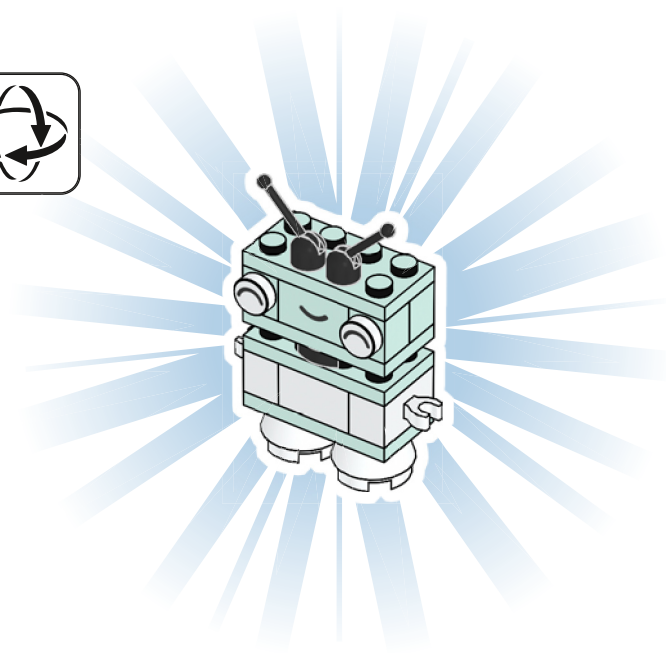

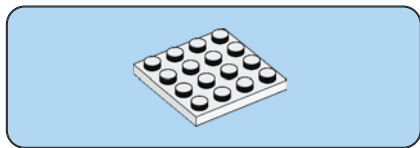
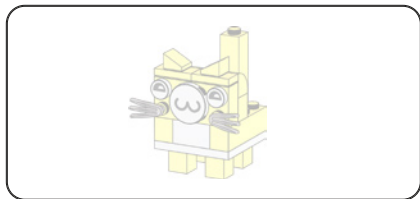

1

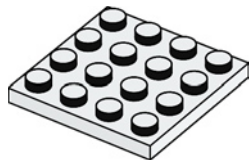

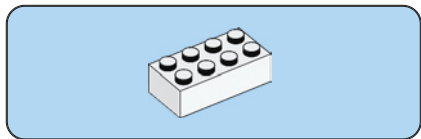

2

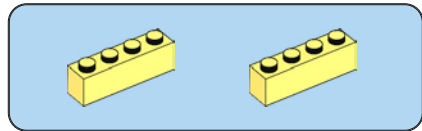
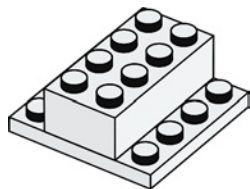

3

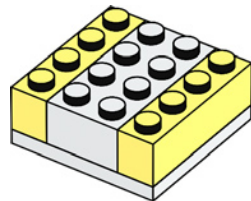

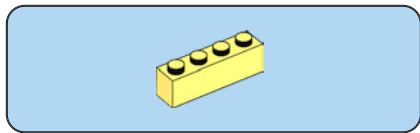

4

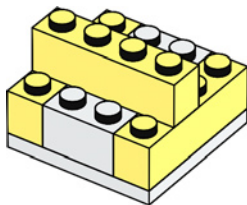



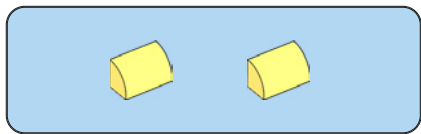

5

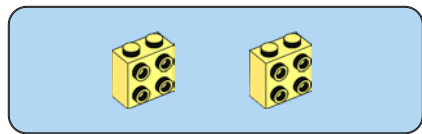
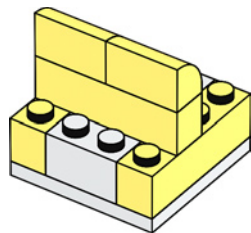

6

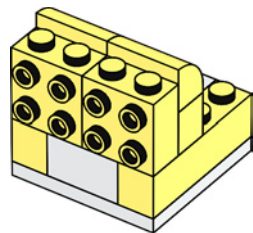

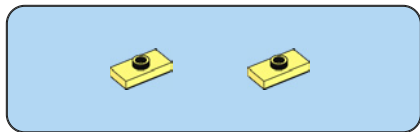

7

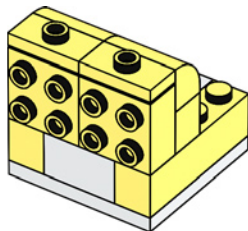

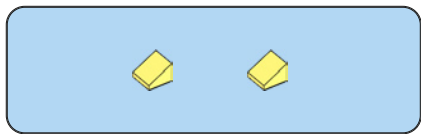

8

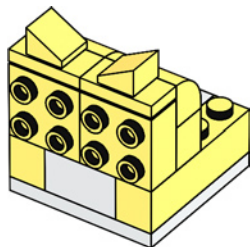

9

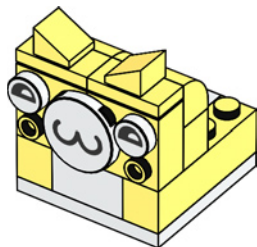

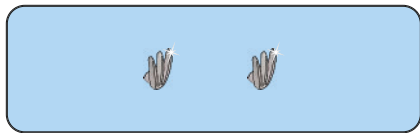

10

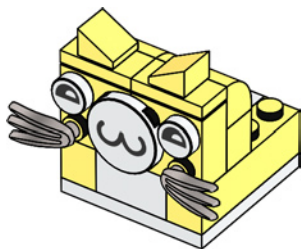



11

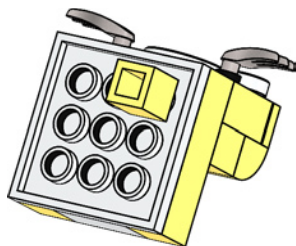

12

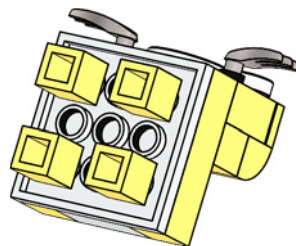

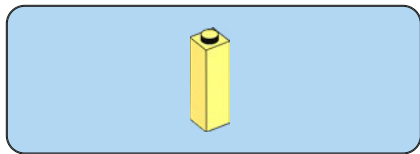

13

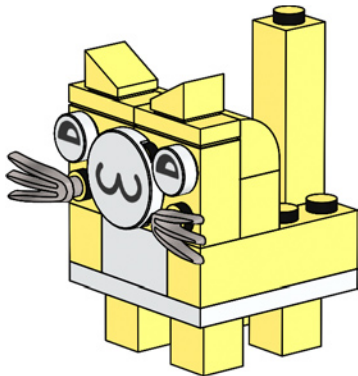

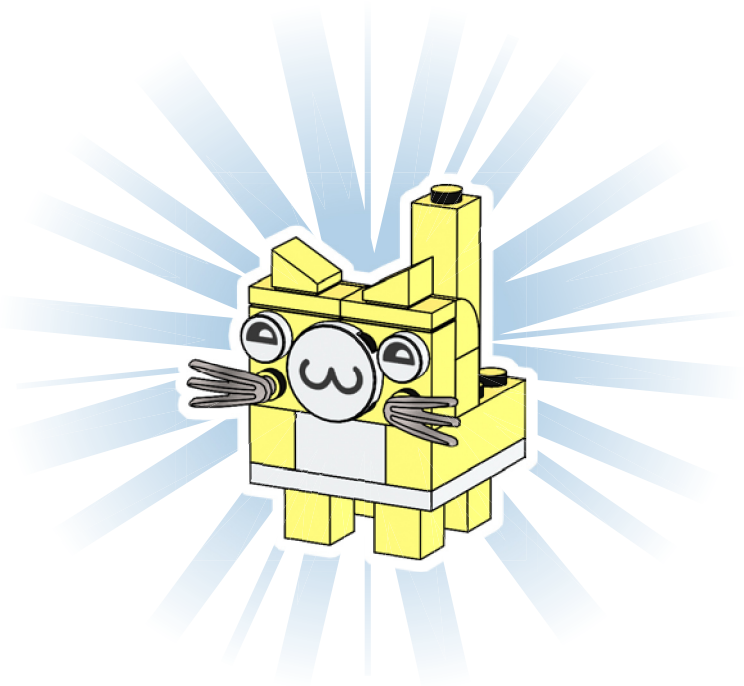

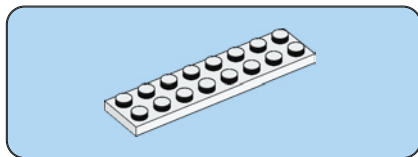
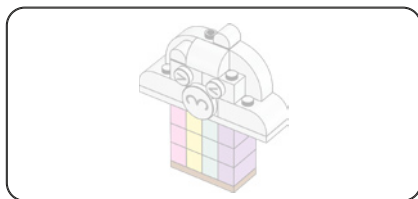

1

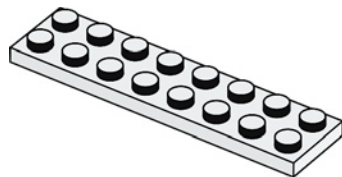





2

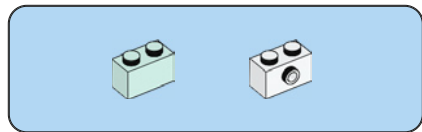
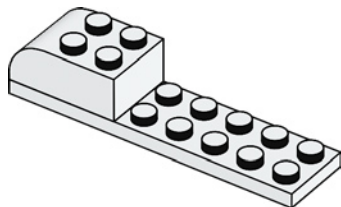

3

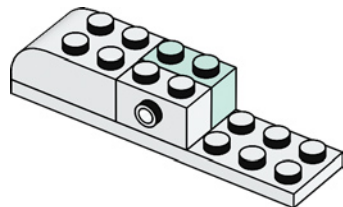



4

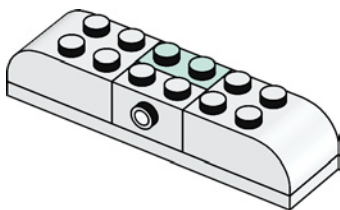

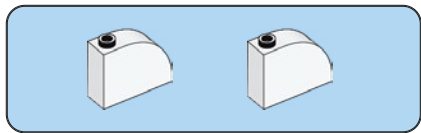

5

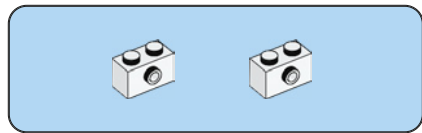
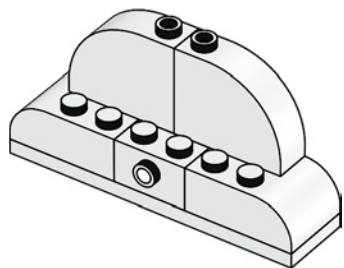

6

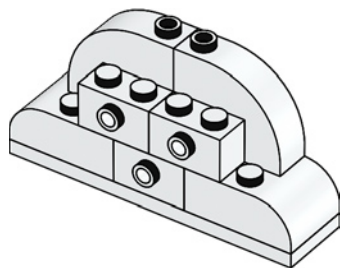

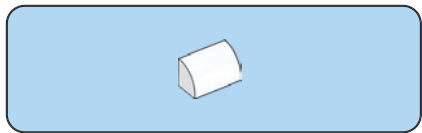

7

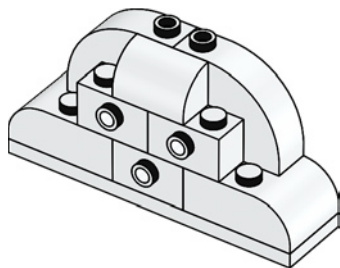

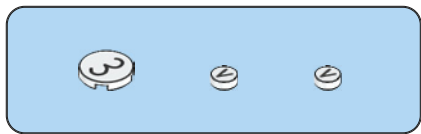

8

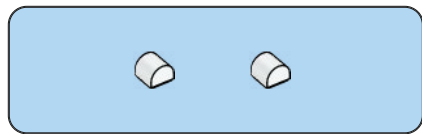
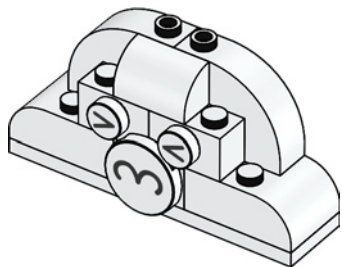

9

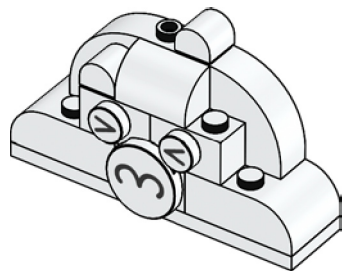



10

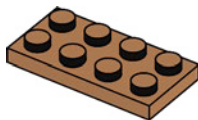

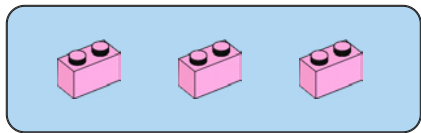

11

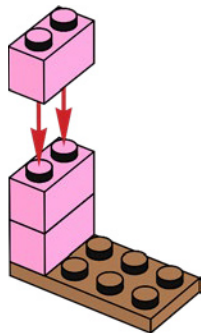

12

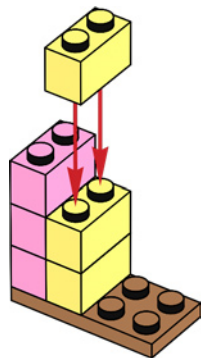

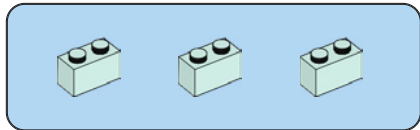

13

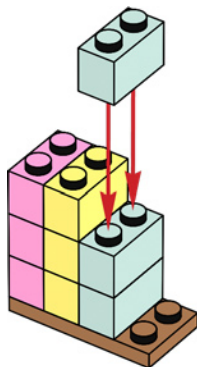



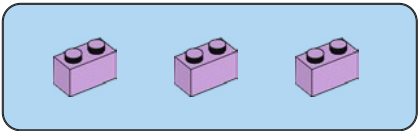

14

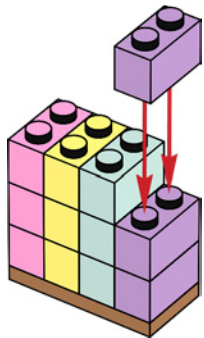

15

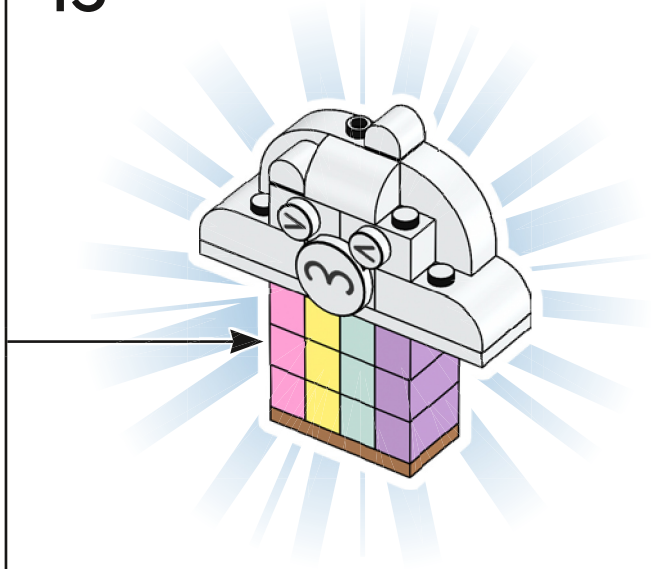

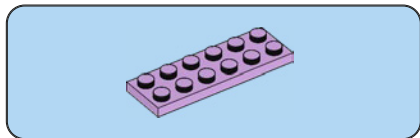
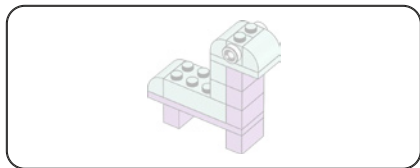

1

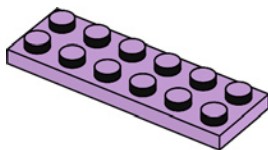



2

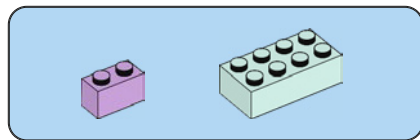
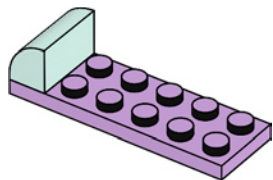

3

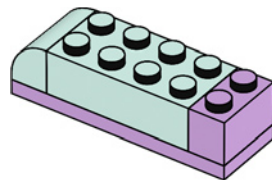

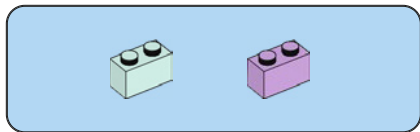

4

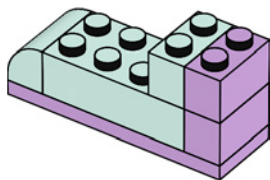

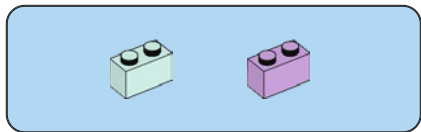

5

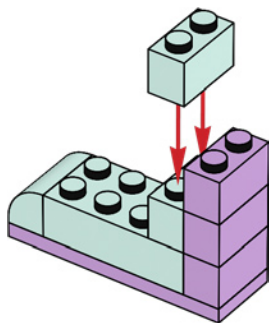

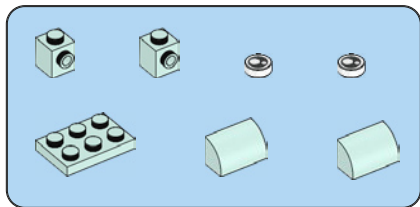

6

1

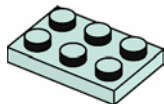

2

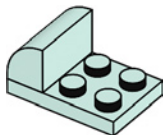

3

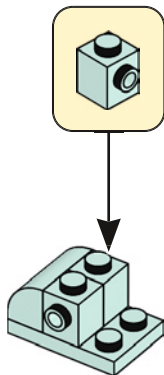

4

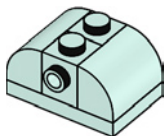

5

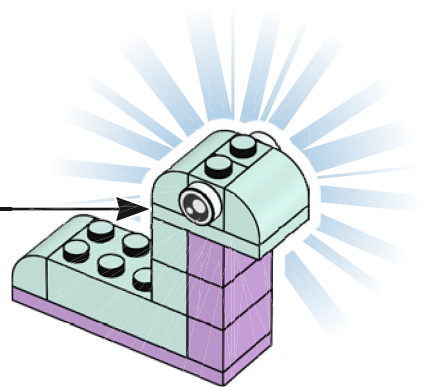
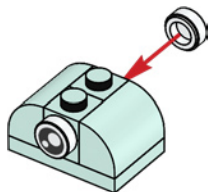

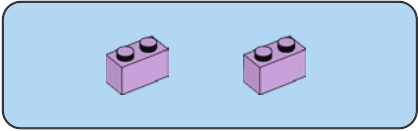

7

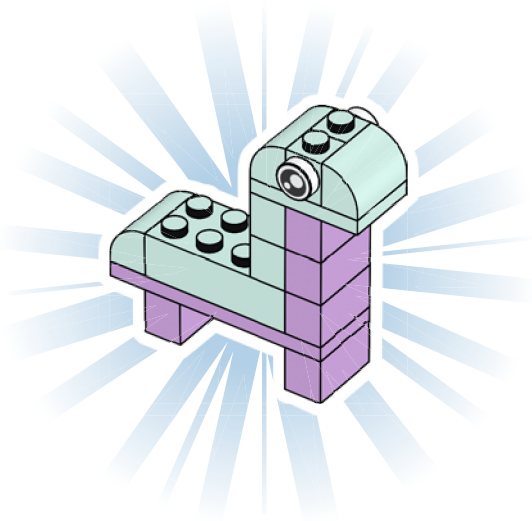







4x  
4286050

4x  
4621554

4x  
4599538

8x  
4517993

2x  
6431714

8x  
4550359

4x  
6143795

4x  
4518890

4x  
4520632

4x  
6426722

8x  
6058085

4x  
6223183

4x  
6135191

4x  
6093494

4x  
6314190

4x  
6057986

4x  
6167690

8x  
4569382

4x  
6022084

4x  
6296498

4x  
6420726

4x  
6296494

4x  
6316264

4x  
6195266

8x  
6022083

8x  
6212064

4x  
6424475

4x  
6036232

4x  
6253939

4x  
6373312

4x  
4619815

4x  
6236576

2x  
6434345

4x  
6431716

2x  
6431715

2x  
6432105

2x  
6433501

4x  
6284599

2x  
6433502

8x  
6022032

4x  
6236575

4x  
6097303

2x  
6431713

8x  
6426720

4x  
6426724

4x  
6218162

4x  
6426721

4x  
6138662

4x  
6097053

8x  
6099352

4x  
6424622

4x  
6172518

8x  
6099349

4x  
6097867

4x  
6426723

2x  
6334047

2x  
4211180

2x  
4216695

4x  
303901

8x  
300301

4x  
301001

4x  
300101

2x  
4243812

1x  
303601

2x  
303401

4x  
73587

2x  
403226

4x  
6320300

4x  
6383982

4x  
621501

8x  
300401

4x  
4141668

4x  
4558952

4x  
300501

4x  
6258135

2x  
6431712

4x  
4649167

4x  
6248827



 [LEGO.com/service](https://www.LEGO.com/service)

**YOU COULD**  
**WIN**



Scan this QR code or go to  
**LEGO.COM/PRODUCTFEEDBACK** and give  
us your short feedback about this LEGO® set  
for a chance to win a cool LEGO prize.

Terms and Conditions apply\*

**DE: Du könntest GEWINNEN.** Es gelten die Teilnahmebedingungen\* **FR: Tu pourrais GAGNER.** Des conditions s'appliquent\* **IT: Potresti VINCERE tu.** Termini e condizioni sono applicabili\* **ES: Puedes GANAR.** Aplican términos y condiciones\* **PT: Poderá GANHAR.** Aplicam-se termos e condições\* **JA: プレゼント付き! 利用規約が適用されます\*** **ZH: 轻松获奖. 条款和条件适用\*** **KO: 상품의 주인이 되어보세요. 소정의 약관이 적용됩니다\*** **RU: Вы можете ВЫИГРАТЬ.** Действуют положения и условия\* **PL: Szansa na WYGRANĄ.** Obowiązują warunki korzystania\* **CS: Máte šanci VYHRÁT.** Platí všeobecné smluvní podmínky\* **SK: Máte šancu VYHRAŤ.** Platia všeobecné zmluvné podmienky\* **HU: TE IS NYERHETSZ.** Felhasználási feltételek érvényesek\* **RO: Ai putea CÂȘTIGA.** Se aplică termenii și condiții\* **BG: Можете да СПЕЧЕЛИТЕ.** Има определени правила и условия\* **LV: Tu vari LAIMĒT.** Ir spēkā noteikumi un nosacījumi.\* **ET: Sul on võimalus VÕITA.** Kehtivad tingimused\* **LT: Jūs galite LAIMĖTI.** Taikomos sąlygos\*  
\*LEGO.com/productfeedback-terms