



# beds

by **Silentnight**

assembly  
instructions

# What you need to know

Prior to assembling the bedframe, determine whether you would like a high or low setting. This is dependent on mattress depth.

If you have a deeper mattress (25cm and above), a low rail setting is recommended, in this case, select the lower option. For a thinner mattress (24cm and below), we recommend the higher option.

Our side rails are universal. Rotate the side rail to create the low or high option.

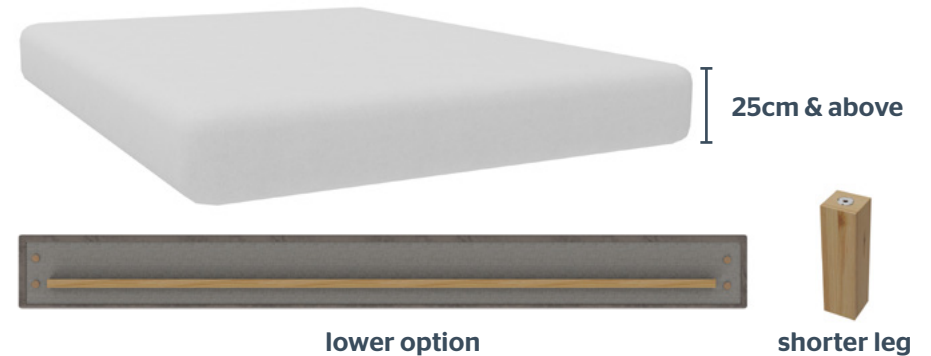

OR

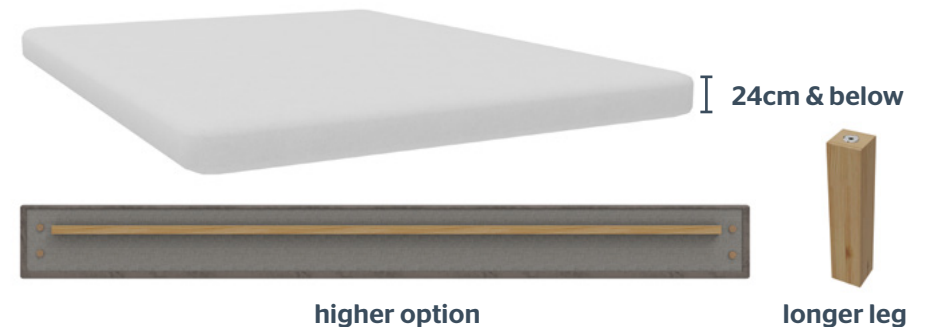

Visit [silentnight.co.uk/guides/assembly-guide](https://www.silentnight.co.uk/guides/assembly-guide) to view our video guide

## This kit contains:

**\*note:** washers only supplied with angled leg options.



Flat Head



x11 35mm  
x6 20mm

M8 Hex



x4 35mm  
x12 20mm

Pan Head



x6 20mm



x1



## Please follow all instructions carefully

**Recommended number of people:** TWO

**Tools required:** Scissors & Phillips Screwdriver.  
Electric screwdriver works best.

1

Select one of the two legs provided, depending on mattress height. If the low rail has been selected (deeper mattress), choose the shorter leg, for the high rail (lower mattress), select the higher leg. Discard the spare.



2

Line up the centre bracket to the leg, screw the 2 holes using the 35mm flat head screw, fixing the leg to the bracket.



3

Insert Glide into the metal socket and push firmly until it clicks.

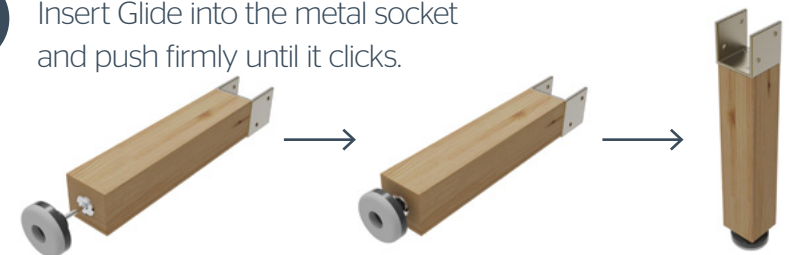

- 4** Attach the support leg with 4 x **20mm pan head screws** in the remaining holes, at the midpoint of the rail. Place this to one side until later.

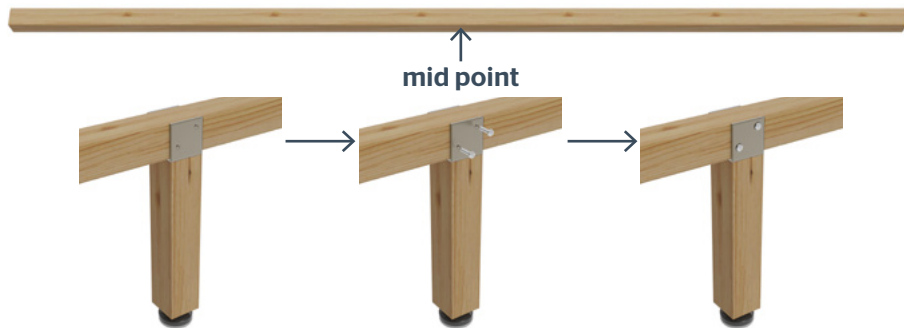

- 5** Insert washers into the legs and screw into the corner brackets x4.

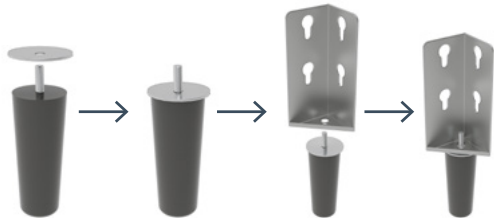

If your bedframe has **angled legs**, position the leg facing the corner.

**Note:** washers only supplied with angled leg options.

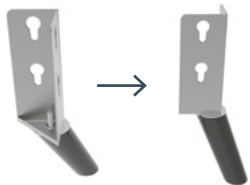

- 6** Laying the headboard and foot end flat. Screw the centre brackets into the headboard and foot end - there will be two options. **Deeper mattress option** insert brackets into lower holes. **Lower mattress option**, insert into the higher holes. Use the 20mm flat head screws for the 3 centre holes.

### Headboard

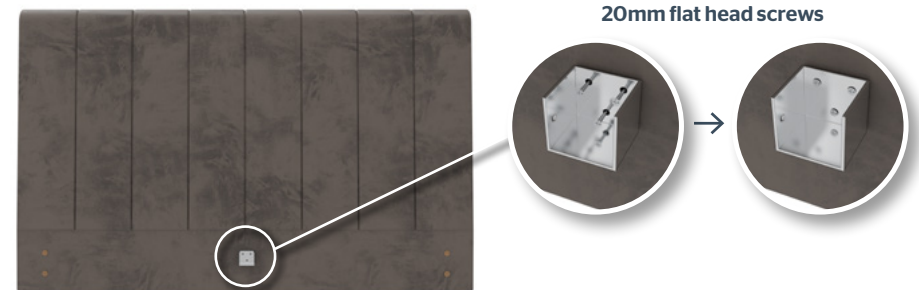

### Foot end

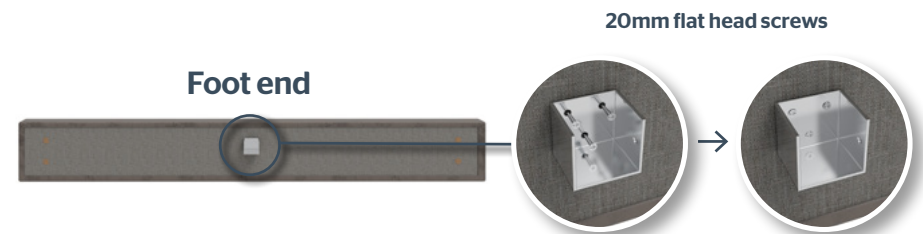

- 7** The side rails are mattress height dependent.  
**Lower option** position the side rail so the shortest gap faces down.  
**Higher option** the side rail should have the shortest gap facing up.

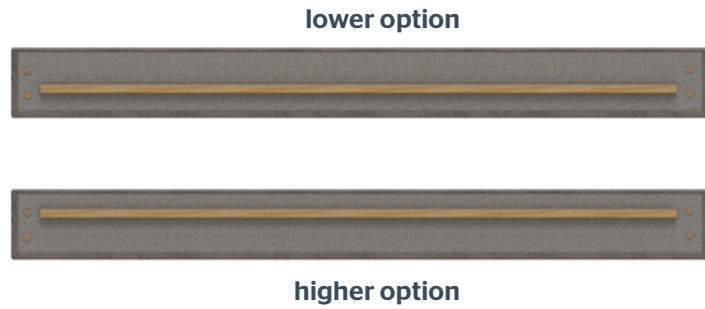

- 8** Position the corner brackets on the side rail edges, and screw in with the **20mm M8 Hex bolts**.  
**DO NOT** fully tighten until later.  
Repeat for all four corner brackets.

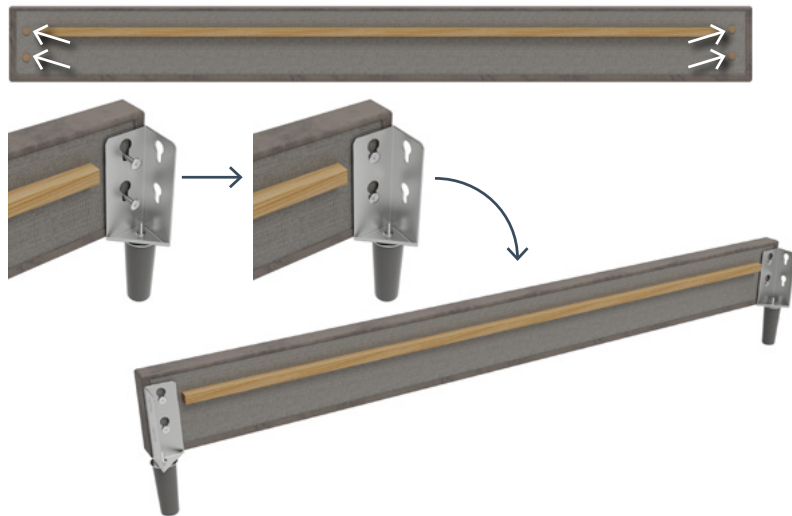

- 9** Loosely screw in the **20mm M8 Hex bolts** to the foot end rail.

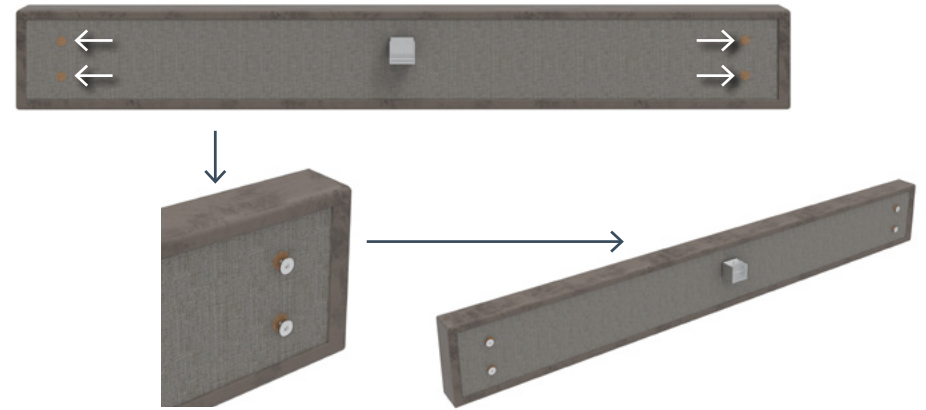

- 10** Fit the side rail corner brackets to the screws in the foot end and tighten up.

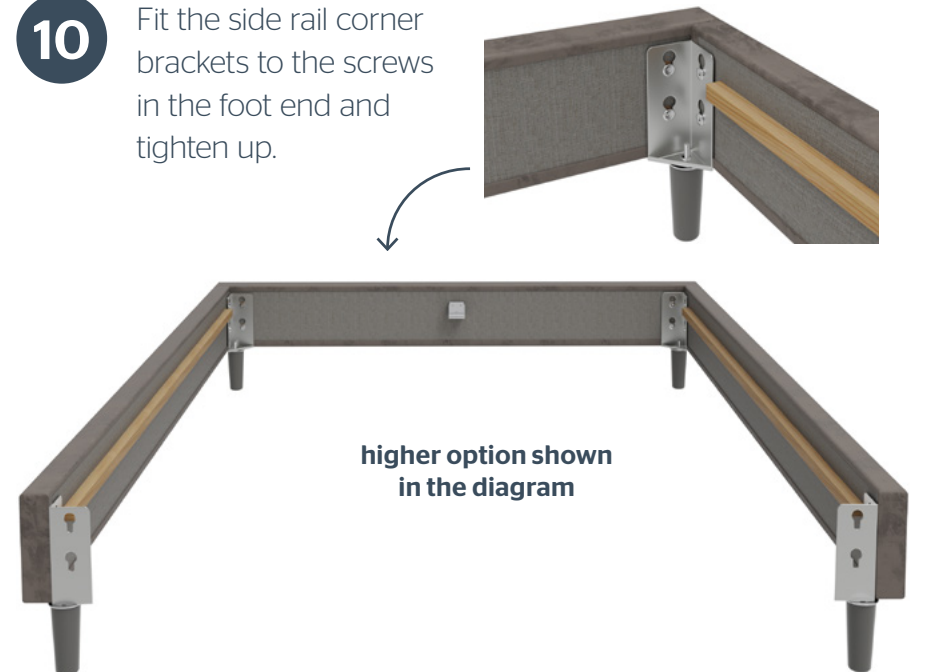

**11** Loosely screw in 4 x **35mm M8 Hex bolts** to the head end.



**12** Carefully position headboard screws over the corner brackets and tighten the screws.



**13** Place the centre rail into headboard and foot end centre brackets. Tighten up the corner brackets from step 8.



**14** With all corner brackets now fully tightened, insert **1x Pan Head screw** into the foot end centre bracket side.

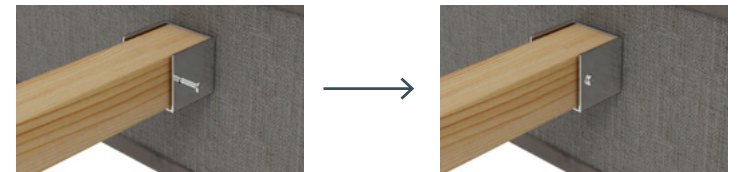

**15** Insert **1x Pan Head screw** into the head end centre bracket.



- 16** Position the lath pack over the bedframe (2 person lift recommended) and open the packaging with scissors.



- 17** Starting at the head end, line the first lath panel so it rests on the support panel as pictured, and insert 1x **35mm Flat Head** screw into the centre and each end of the lath.

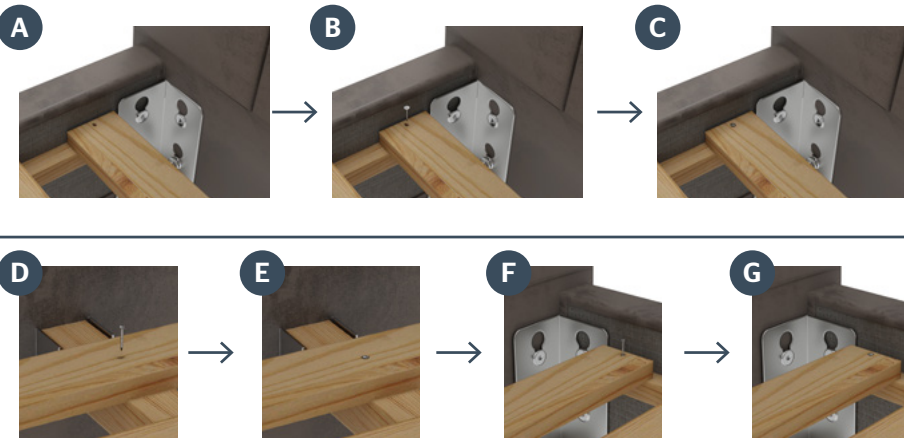

- 18** With the first lath now screwed in, ensure the webbing between is under full tension and repeat the screw process for the central lath panel.



- 19** Lastly, screw in the lath panel closest to the foot end, applying tension between webbing, to ensure even lath coverage.



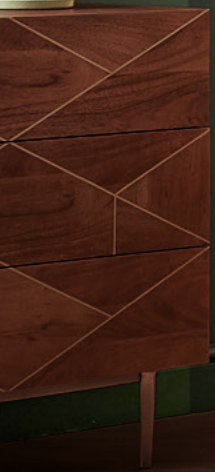



beds

by Silentnight



For any assembly guidance or queries please call  
our customer service team on **0333 123 0892**

Our customer service lines are open:

**Mon - Thurs** 8:30 - 17:00 | **Friday** 8:30 - 16:30