



User manual
Heat-Pump-Dryer

HD90-A2979

HD100-A2979

HD80-A3979

HD90-A3979

HD90-A3979S

HD90-A3S979

GB

Haier

Thank you for purchasing a Haier Product.

Please read these instructions carefully before using this appliance. The instructions contain important information which will help you get the best out of the appliance and ensure safe and proper installation, use and maintenance.

Keep this manual in a convenient place so you can always refer to it for the safe and proper use of the appliance.

If you sell the appliance, give it away, or leave it behind when you move house, make sure you also pass this manual so that the new owner can become familiar with the appliance and safety warnings.

Legend



Warning! – Important safety information



General information and tips



Environmental information

Disposal



Help protect the environment and human health. Put the packaging in applicable containers to recycle it. Help to recycle waste of electrical and electronic appliances. Do not dispose appliances marked with this symbol with the household waste. Return the product to your local recycling facility or contact your municipal office.



WARNING!

Risk of injury or suffocation!

Disconnect the appliance from the mains supply. Cut off the mains cable and dispose of it. Remove the door catch to prevent children and pets to get closed in the appliance.



WARNING!

The appliance must not be supplied through an external switching device, such as a timer, or connected to a circuit that is regularly switched on and off by a utility.

Safety information	4
Intended use.....	7
Product description.....	8
Control panel.....	9
Programmes.....	12
Consumption	13
Suggestions and tips.....	14
Daily use.....	16
Care and cleaning.....	20
Troubleshooting	22
Installation.....	24
Technical data	26
Customer Service	30



WARNING!

Before first use

- ▶ Make sure there is no transport damage.
- ▶ Remove all packaging and keep out of children's reach.
- ▶ Handle the appliance always with at least two persons because it is heavy.

Daily use

- ▶ This appliance can be used by children aged from 8 years and above and persons with reduced physical, sensory or mental capabilities or lack of experience and knowledge if they have been given supervision or instruction concerning use of the appliance in a safe way and understand the hazards involved.
- ▶ Keep away children under 3 years of age from the appliance unless they are constantly supervised.
- ▶ Children shall not play with the appliance.
- ▶ Do make sure the room is dry and well ventilated. The ambient temperature should be between 5 °C and 35 °C.
- ▶ Do not cover any ventilation openings in the base by a carpet or similar object.
- ▶ Keep the area around the tumble dryer free of dust and lint.
- ▶ Do make sure that there is only laundry inside the appliance and no pets or children before you use it.
- ▶ Only touch the mains plug with dry hands and do not touch or use the appliance if you are barefoot or have wet or damp hands or feet.
- ▶ Only dry textiles washed in water.
- ▶ Do make sure not to load more than nominal load.
- ▶ Remove all items such as lighters and matches from pockets.
- ▶ Use fabric softeners or similar products as specified by the manufacturer's packaging.
- ▶ Do not use or store any flammable sprays or flammable gas in close vicinity to the appliance.
- ▶ Do not place heavy objects or sources of heat or damp on top of the appliance.
- ▶ Hold the plug, not the cable, when unplugging the appliance.
- ▶ Do not touch the rear wall and the drum during operation; they are hot.

**WARNING!****Daily use**

- ▶ Do not dry following items in the appliance:
 - ▶ Items which are unwashed.
 - ▶ Items which have been contaminated with inflammable substances such as cooking oil, acetone, alcohol, benzine, petrol, kerosene, spot removers, turpentine, waxes, wax removers or other chemicals. The fumes can cause a fire or explosion. These items must always be washed first by hand in hot water with an extra amount of detergent and then be dried in the open air before drying in the appliance.
 - ▶ Items which contain padding or fillings (e.g. pillows, jackets), as the filling can get out with the risk of igniting in the dryer.
 - ▶ Items which contain a large proportion of rubber, foam rubber (latex foam) or rubber like materials such as shower caps, waterproof textiles, rubberised articles and items of clothing and pillows with foam rubber filling.
- ▶ Do not drink the condensed water.
- ▶ Do not use the appliance without the lint filter or condenser filter in place or with damaged filter.
- ▶ Notice that the last part of the drying cycle occurs without heat (cool down cycle) to ensure remaining the garments at a temperature which does not damage them.
- ▶ Do not leave the appliance unattended during run time for some time. If a long absence is intended, the drying cycle have to be interrupted by switching off the unit and unplugging the mains.
- ▶ Do not switch off the appliance except drying cycle is finished, unless all items are quickly removed and spread out that the heat can be released.
- ▶ Switch off the appliance after each drying programme to save electricity and for safety.

Maintenance / cleaning

- ▶ Make sure children are supervised if they carry out cleaning and maintenance.
- ▶ Disconnect the appliance from the electrical supply before undertaking any routine maintenance.



WARNING!

Maintenance / cleaning

- ▶ Clean the lint filter and the condenser filter after each programme (see CARE AND CLEANING).
- ▶ Do not use water spray or steam to clean the appliance.
- ▶ Do not use industrial chemicals to clean the appliance.
- ▶ Replace a damaged supply cord only by the manufacturer, its service agent or similarly qualified persons in order to avoid a hazard.
- ▶ Do not try to repair the appliance by yourself. In case of repair please contact our customer service.

Installation

- ▶ Ensure a location which allows opening the door fully. Do not install the tumble dryer behind a lockable door, a sliding door or a door with hinges on the opposite side of the tumble dryer door as this limits the full opening of the tumble dryer door.
- ▶ Install the appliance in a well-ventilated, dry place.
- ▶ Never install the appliance outdoors in a damp place, or in an area which may be prone to water leaks such as under or near a sink unit. In the event of a water leak cut power supply and allow the machine to dry naturally.
- ▶ Install or use the appliance only where the temperature is above 5 °C.
- ▶ Do not place the appliance directly on a carpet, or close to a wall or furniture.
- ▶ Do not expose the appliance to any frost, heat or direct sunlight or in the near of heat sources (e.g. stoves, heaters).
- ▶ Make sure that the electrical information on the rating plate agrees with the power supply. If it does not, contact an electrician.
- ▶ Do not use multi-plug adapters and extension cables.
- ▶ Make sure not to damage the electric cable and the plug. If damaged have it replaced by an electrician.
- ▶ Use a separate earthed socket for the power supply which is easy accessible after installation. The appliance must be earthed.
- ▶ Only for UK: The appliance's power cable is fitted with 3-cord (grounding) plug that fits a standard 3-cord (grounded) socket. Never cut off or dismount the third pin (grounding). After the appliance is installed, the plug should be accessible.

Intended use

This appliance is intended for drying items which have been washed in a water solution and are marked on the manufacturer's care label as being suitable for tumble drying.

It is designed exclusively for domestic use inside the house. It is not intended for commercial or industrial use. Changes or modifications to the device are not allowed. Unintended use may cause hazards and loss of all warranty and liability claims.

Standards and directives

This product meets the requirements of all applicable EC directives with the corresponding harmonised standards, which provide for CE marking.



Notice

The appliance contains the fluorinated greenhouse gas HFKW-134a (GWP:1430). This gas is hermetically sealed.



Environmentally responsible use

- ▶ **Thorough drainage:** Spin the laundry with the maximum spin speed.
- ▶ **Maximum load:** Use the maximum filling amount according to the programme table, but do not overload the dryer. To take advantage of the maximum load, the laundry which should be dried „READY to STORE“, can be first dried easily with „READY to IRON“. At the programme end remove the laundry which should be ironed and dry the remaining laundry then to end.
- ▶ **Loosen up the laundry:** Shake out the laundry before putting them into the dryer.
- ▶ **Avoid excess drying:** An excessive drying should be avoided. Select the right programme and the appropriate dry level.
- ▶ **Softener unnecessary:** Do not use softener when washing, because the laundry will become fluffy and soft in the dryer .
- ▶ **Cleaning of the lint filters:** Clean the lint filters after each cycle.
- ▶ **Ventilation:** Make sure the appliance is properly ventilated (see INSTALLATION).
- ▶ **Condensed water reuse:** The collected condensed water can be used for the steam iron. Before it should be poured through a fine sieve or coffee filter paper. Smallest parts will be retained by the filter.

Note:

Due to technical changes and different models, the illustrations in the following chapters may differ from your model.

3.1 Picture of appliance

Front (Fig. 3-1):

Rear side (Fig. 3-2):

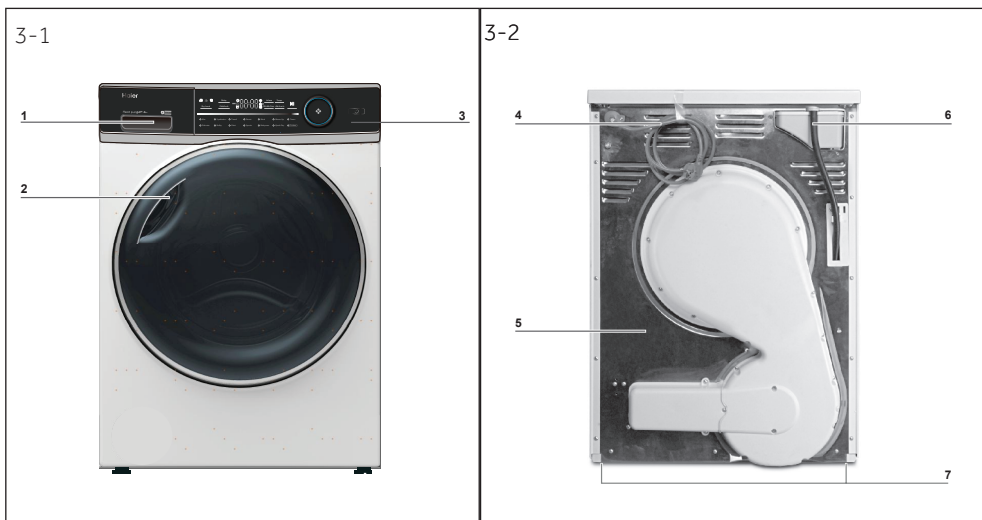

- 1 Water tank
- 2 Tumble dryer door
- 3 Control panel

- 4 Power supply cord
- 5 Back plate
- 6 Drainage outlet
- 7 Adjustable feet

3.2 Accessories

Check the accessories and literature in accordance with this list (Fig.:3-3):

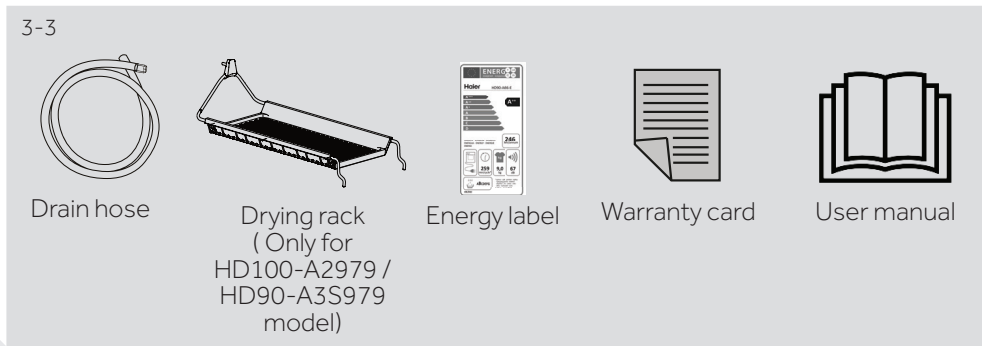

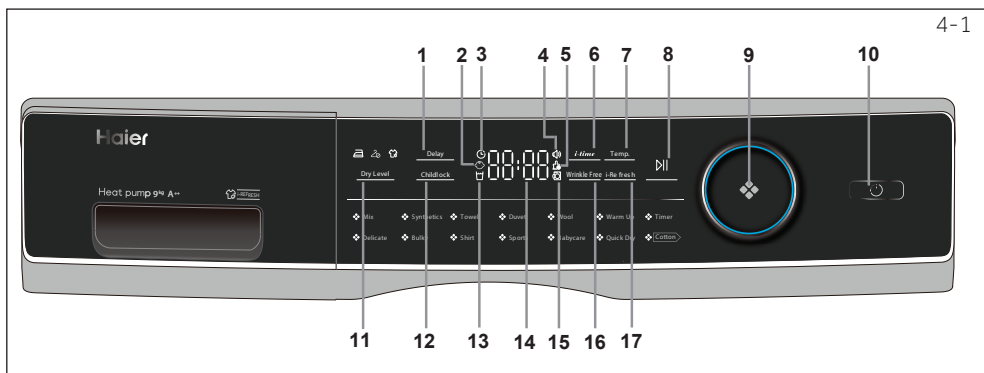

- | | | |
|--------------------------|----------------------|--------------------------|
| 1 Delay button | 7 Temp. button | 13 Empty tank indicator |
| 2 Child-lock indicator | 8 Start/Pause button | 14 Display |
| 3 Timer indicator | 9 Program knob | 15 Door unlock indicator |
| 4 Signal indicator | 10 Power button | 16 Wrinkle Free button |
| 5 Clean filter indicator | 11 Dry level button | 17 i-Refresh |
| 6 Time button | 12 Childlock button | |

4.1 Delay button

Delay function for delay start, press the button to set time (in 1 intervals up to 12 hours). The appliance should be finished in, afterwards press to start (Fig. 4-2) the delayed operation.



Notice

This function should be set after you have finished all the options, otherwise when you turn the knob or press the button, the function will be deleted automatically.

4.2 Child lock indicator

To activate the Child-lock function after a cycle has been started, press the Childlock button (Fig. 4-3) for 3 sec. until the indicator icon lights up. To deactivate press the button for 3 sec. again.



Notice

When the cycle ends or the power supply is interrupted, the function will not be cancelled automatically.

4.3 Timer indicator

When choose the timer program (Fig. 4-4), It will lights up.



4.4 Signal indicator

You can choose signal as you need. To active the signal function after switching on the dryer, press *i-time* and Temp. (Fig. 4-5) for about 3 seconds until the beep sounds. To deactivate press both buttons for 3 seconds again until the beep sounds.



4-6

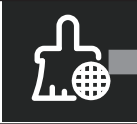

4.5 Clean filter indicator

Filters must be cleaned regularly. See Lint Filter Cleaning or Condenser Filter Cleaning section of the manual.



Notice

After each cycle, indicator will flash to remind cleaning the filters.

4-7



4.6 Time button

When select the Timer or Delay program, then the light of *i-time* is on. Press this button to add or subtract the time.

4-8



4.7 Temp. button

Press the button (Fig. 4-8) to set the drying temperature for some programs. The display is shown below:

- [- -] High temperature.
- [- -] Middle temperature.
- [- -] Low temperature.
- [0 0] Cool air.

4-9

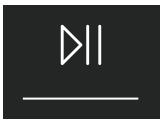

4.8 Start/Pause button

Press Start/Pause (Fig. 4-9) to Start a drying cycle. Press button again to pause the drying cycle – indicator light is flashing. Press button again to continue.

4-10

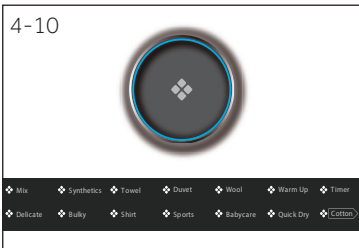

4.9 Program knob

Select one of the 12 programs using the knob (Fig. 4-10). The indicator of the respective program lights up. See Program Modes section of the manual for further information.

4-11



4.10 Power button

Press Power button (Fig. 4-11) to switch on/off the tumble dryer.

4-12

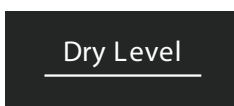

4.11 Dry Level button

Press the button (Fig. 4-12) to set the final moisture content of the laundry at the end of cycle.

- Extra dry
- Ready to store
- Ready to iron

4.12 Childlock button

To activate the Child-lock function after a cycle has been started, press the button (Fig. 4-13) for 3 sec. until the indicator icon lights up. To deactivate press the button for 3 sec. again.



4.13 Empty tank indicator

Water tank must be emptied.

Important: Empty the water tank after each drying cycle. See Empty the water tank section of the manual.



4.14 Display

The display shows the remaining time, the delay time and other related information.

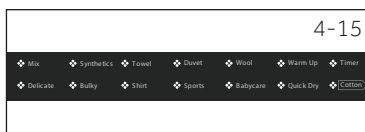

Notice

The remaining time is a default value, this time will be re-calculated depending on additional program settings and the moisture content of the laundry.

4.15 Door unlock indicator

If the door open, this indicator (Fig. 4-16) will light up..



4.16 Wrinkle Free button

After selecting the program with this function, the icon lights up, anti-wrinkle default open, when we touch this button (Fig. 4-17) display will show OFF, anti-wrinkle closed, and touch again display will show ON, anti-wrinkle open.





Notice

The default time is 1 hour.

4.17 i-Refresh

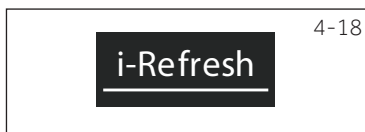
A timer program, default time is 30 minutes. The longest time is 50 minutes.





Programme	Drying degree	Laundry	Max. Load kg		
			8	9	10
Mix	Extra dry	Heavy fabrics, need further drying	5	6	7
Synthetics	Extra dry	Heavy synthetic	4	4,5	5
Towel **)	Extra dry	Towels	5	6	7
Duvet	/	Feather clothing	1	1	1,5
Wool	/	Woolfell textiles	3	3	4
Warm up	Extra dry	Cashmere clothing	3	4	4,5
Timer	/	Heavy fabrics, need further drying	-	-	-
Delicate	Extra dry	Underwear	2	2	3
Bulky **)	Extra dry	Heavy cotton	2	2	3
Shirt	Extra dry	Shirts	4	4,5	5
Sports	Extra dry	Sportswear	4	4,5	5
Babycare	Extra dry	Baby clothing	4	4	5
Quick Dry	/	Sheets	4	4	5
 Cotton	Extra dry	Cotton, coats	8	9	10

*) EN 61121 test program setting.

**) These programs have reversing function specially for big load.

Heat pump technology

The condensation dryer with heat exchanger is outstanding in terms of efficient energy consumption. These are guide values determined under standard conditions. The values may differ from those given, depending on overvoltage and undervoltage, the type of fabric, composition of the laundry to be dried, the residual moisture in the fabric and the size of the load.

Programme Cotton / Linen	Spin speed in rpm	Restidual moisture in %	Time in h:min	Energy consumption in kWh
Extra Dry 	1000	approx. 60	4:40	2.34
Ready to Store 	1000	approx. 60	4:29	1.98
Ready to Iron 	1000	approx. 60	3:18	1.62



Environmentally responsible use

- ▶ Spin the laundry as dry as possible before putting it into the tumble dryer.
- ▶ Avoid overloading the tumble dryer.
- ▶ Shake the laundry loose before putting it into the tumble dryer.
- ▶ Choose a proper drying program. Make sure the laundry is not dried longer than needed.
- ▶ Make sure to use the tumble dryer with cleaned filters.

7.1 Starched laundry

Starched laundry leaves a film of starch in the drum and is not suitable for the dryer.

7.2 Softener

Do not use softener when washing, because the laundry will become soft and fluffy in the dryer.

7.3 Soft care cloths

The use of "soft care cloths" can lead to a coating at the lint filters. This can cause a blockage of the filters. In such cases, we recommend either to abstain from adding soft care cloths or to choose a different brand. In any case note the manufacturer's instructions.

7.4 Small amounts of filling

In a quantity of less than 1.0 kg, the "Timer"-programme should be selected because the automatic scanning of the dry level can be captured only still inaccurate.

7.5 Open door

The door should be left ajar during the non-use, so that the door seal indefinitely remains in effect.

7.6 Drum interior light

When the appliance is switched on, always the drum interior light lights when door is open .

7.7 Service flap

Make sure that the service flap is always closed during operation.

7.8 Anti crease protection

If at the end of the programme the laundry is not removed, the drum moves from time to time to prevent creasing. The anti crease protection phase is approx. 60 minutes.

7.9 Laundry which should be ironed

...should be dried with level READY to IRON . This facilitates ironing by hand or using the machine.

7.10 Remaining time

The programme duration is influenced by the following factors: the type of fabric, the filling quantity, absorptive capacity, the desired dry level, as well as the spin speed of the washing machine. These factors are registered by the electronics during the programme and the remaining time will be corrected accordingly.

7.11 AUTO load detection system

When the programme starts, after a few minutes the display will show **AUTO**. This means the automatic load detection is in progress. Sensors are detecting and estimating the selected programme time to finish. Depending on the programme selected, load quantity, humidity and ambient temperature, the AUTO load detection phase can last a few minutes for small load, or up to hour for the maximum load or large items, before displaying the approximate programme time remaining to finish the programme.

7.12 Extra large pieces

... tend to wind up. If therefore the desired dry level could not be reached, loosen up the laundry and dry again with the time programme (TIMER).

7.13 Especially delicate fabrics

Textiles which can easily shrink or lose their shape, as well as e.g. silk stockings, lingerie etc. should not be put in the dryer. Put delicate garments inside a laundry bag and avoid over drying them.

7.14 Jersey and knitwear

should be dried at READY to IRON  to avoid shrinkage. A subsequent stretch or pull into form should be performed.

7.15 Fluff

The amount of lint in the lint filters is not attributable to the wash stress in the dryer; rather, it is extracted fibres from the wearing and washing. During drying on the line, the fluff will be carried away by the wind. By using a tumble dryer the fluff will be collected in the filters.

7.16 Acoustic signal

An acoustic signal sounds:

- ▶ when the water tank is full
- ▶ in case of failures

Additionally the acoustic signal can also be selected for following cases:

- ▶ at the end of programme
- ▶ when pressing a button
- ▶ when turning the programme selector

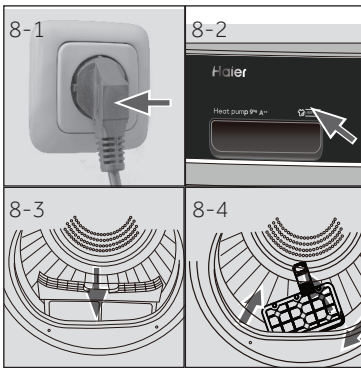

8.1 Preparing the appliance

1. Connect the appliance to a power supply (220V to 240V~/50Hz) (Fig. 8-1) Please refer also to section INSTALLATION.
2. Make sure:
 - ▶ the water tank is empty and properly installed. (Fig. 8-2).
 - ▶ the lint filter is clean and properly installed. (Fig. 8-3).
 - ▶ the condenser filter is clean and properly installed (Fig. 8-4).

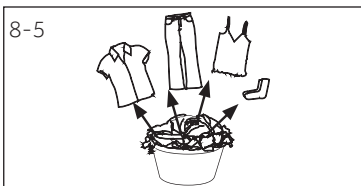

8.2 Preparing the laundry

- ▶ Sort clothes according to fabric (cotton, synthetics, wool etc.). Only dry laundry that has been spun.
- ▶ Empty pockets of all sharp or flammable objects such as keys, lighters and matches. Remove harder decorative objects such as brooches.
- ▶ Close zippers and hooks, make sure the buttons are sewn on tightly and place small items such as socks, bras etc. in a wash bag.
- ▶ Unfold large pieces of fabric such as bed sheets, table cloth etc.
- ▶ Follow the instructions on the laundry label and dry only machine-dryable garments.



i Tips:

- ▶ Separate white clothes from coloured ones.
- ▶ Unfold large items such as bed sheets, table cloths, etc.
- ▶ Bed linen and pillowcases should be buttoned, so that small parts cannot collect inside.
- ▶ Close zippers and hooks, and tie loose belts without metal parts, apron strings etc. together.
- ▶ Place small items such as socks, belts, bras, etc. in a wash bag.
- ▶ Make sure all buttons are sewn on tightly.
- ▶ Sew or remove loose metal parts of garments, such as e.g. metal buttons, bow of bras before inserting. Otherwise such parts can cause noise and damage the drum.
- ▶ Do not over-dry easy-care linen. Risk of the crease. Allow final drying at the air.
- ▶ Knitwear (e.g. T-shirts, underwear) sometimes run up during drying. Only use dry level READY to IRON  and drag in the form afterwards.
- ▶ For pre-dried, multi-layered garments or for final drying the time-programme (TIMER) should be chosen.

Load Reference		
Bed sheet (single)	Cotton	Approx. 800 g
Blended fabric clothes	/	Approx. 800 g
Jackets	Cotton	Approx. 800 g
Jeans	/	Approx. 800 g
Overalls	Cotton	Approx. 950 g
Pyjamas	/	Approx. 200 g
Shirts	/	Approx. 300 g
Socks	Blended fabrics	Approx. 50 g
T-Shirts	Cotton	Approx. 300 g
Underwear	Blended fabrics	Approx. 70 g

8.3 Loading the appliance

- ▶ Loosen up and insert presorted laundry.
- ▶ Don't overload.
- ▶ Close the door carefully. Make sure that no pieces of laundry are pinched.

8.4 Removing and adding laundry

To remove or add laundry the programme can be interrupted at any time:

- ▶ Open the door. The cycle interrupts.
Be careful when removing or adding the laundry! The interior of the drum or the laundry itself may be hot, so that there is danger of burns .
- ▶ To continue the programme, press the "Start/Pause" button after closing the door.



CAUTION!

Non-textile, as well as small, loose or sharp-edged items may cause malfunctions and damage of clothes and appliance.



WARNING!

Never turn the dryer off before the end of the drying cycle unless all items are quickly removed and spread out that the heat can be released.

8.5 Loading the dryer

1. Place the laundry evenly in the drum making sure not to overload the dryer.
2. Switch on the tumble dryer by pressing the Power button (Fig. 8-7).



Notice

Fabric softeners or similar products should be used as specified in the manufacturer's instructions.

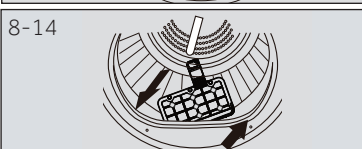
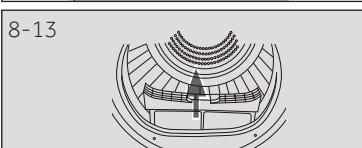
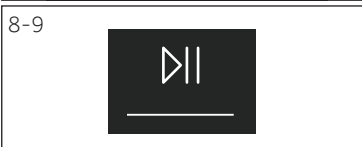

8.6 Set program and start

1. Turn the program knob (Fig. 8-8) to select the desired program.
2. Set functions such as Temperature, Dry level, Delay. Afterwards press the Start/Pause button (Fig. 8-9) to start the dry cycle.

8.7 End of dry cycle

The tumble dryer stops operation automatically when a dry cycle is complete. The display shows END. Open the tumble dryer door and remove the laundry. If the laundry is not removed the anti-crease program starts automatically.

1. Switch off the tumble dryer by pressing the Power button (Fig. 8-10).
2. Unplug the tumble dryer from the power socket (Fig. 8-11).
3. Empty the water tank after each dry cycle (Fig. 8-12).
4. Clean the lint filter after each dry cycle (Fig. 8-13).
5. Clean the condenser filter after each dry cycle (Fig. 8-14).

Notice

- ▶ During drying, please make sure the items are placed on the rack with no risk of entangling the baffles while the drum is rotating.
- ▶ Maximum weight of wet items: 1.5 kg.

8.8 Using the dryer rack

The dryer rack is designed for use with items which are not recommended for tumble drying such as trainers, sneakers, sweaters or delicate lingerie.



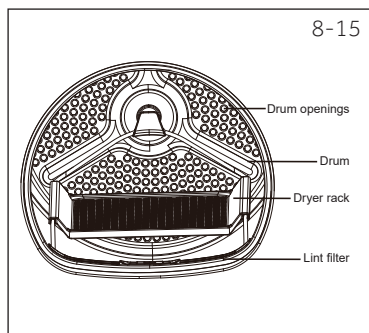



















1. Open the dryer door.
2. Check that the drum is empty.
3. Put the dryer rack into the drum.
4. Make sure the catches are inserted in the hole of the lint filter and locked in the hole of rear drum.



Notice

- ▶ Do not use this dryer rack when there are other clothes in the dryer.

Care chart

Washing		
 Washable up to 95°C normal process	 Washable up to 60°C normal process	 Washable up to 60°C mild process
 Washable up to 40°C normal process	 Washable up to 40°C mild process	 Washable up to 40°C very mild process
 Washable up to 30°C normal process	 Washable up to 30°C mild process	 Washable up to 30°C very mild process
 Wash by hand max. 40°C	 Do not wash	
Bleaching		
 Any bleaching allowed	 Only oxygen/ non -chlorine	 Do not bleach
Drying		
 Tumble drying possible normal temperature	 Tumble drying possible lower temperature	 Do not tumble dry
 Line drying	 Flat drying	
Ironing		
 Iron at a maximum temperature up to 200°C	 Iron at a medial temperature up to 150°C	 Iron at a low temperature up to 110°C; without steam (steam ironing may cause irreversible damage)
 Do not iron		

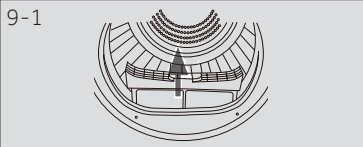

9.1 Lint filter cleaning

Clean the lint filter after each dry cycle.

1. Remove the lint filter from the drum (Fig.9-1).
2. Open up the lint filter (Fig.9-2).
3. Clean the lint filter from any lint residuals (Fig.9-3).
4. Reinstall the cleaned lint filter in the tumble dryer (Fig.9-4).

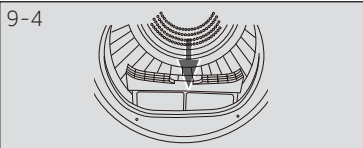
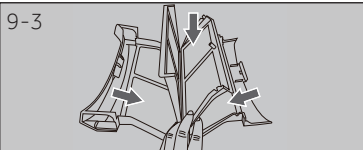
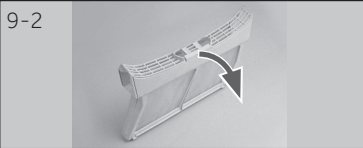

9.2 Condenser filter cleaning

Clean the lint filter after each dry cycle.

1. Open the door.
2. Pull out the lint filter from its housing (Fig.9-5).
3. Pull out the condenser filter from the air duct (Fig.9-6).
4. Remove the sponge and clean the filter screen from any residuals (Fig.9-7).
5. Reinstall the sponge to the condenser filter (Fig.9-8).

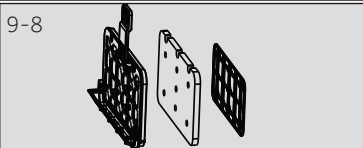
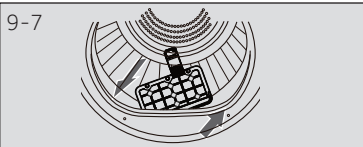
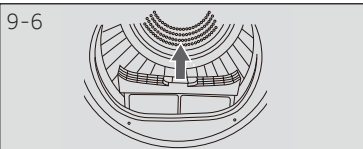
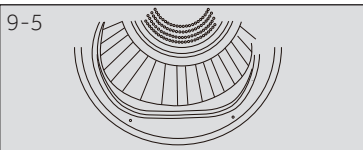

Notice

If the lint / the condenser filter is very dirty, it can be cleaned under running water. Let it dry thoroughly before use.

9.3 Empty the water tank

During operation, steam condenses to water which is collected in the water tank. Empty the water tank after each drying cycle.

1. Pull out the water tank from its housing (Fig. 9-9).
2. Empty the water tank (Fig. 9-10).
3. Reinstall the water tank to the tumble dryer (Fig. 9-11).



Notice

Do not use the water for any kind of drinking or food processing.

9.4 Tumble dryer

Wipe the outside of the tumble dryer and the control panel with a damp cloth. Do not use any organic solvent or corrosive agent to avoid damage to the device.

9.5 Drum

After some operation time, fabric care agents or calcium contained in the water can form an almost invisible film on the inside of the drum. Use a damp cloth and some detergent to remove it. Do not use any organic solvent or corrosive agent to avoid damage to the device.

9.5 Evaporator

If the evaporator behind the condenser filter is dirty, it can be cleaned by use of a vacuum cleaner. Make sure not to damage the evaporator while cleaning it.

Many occurring problems could be solved by yourself without specific expertise. In case of a problem please check all shown possibilities and follow below instructions before you contact an after sales service. See CUSTOMER SERVICE.



WARNING!

- ▶ Before maintenance, deactivate the appliance and disconnect the mains plug from the mains socket.
- ▶ Electrical equipment should be serviced only by qualified electrical experts, because improper repairs can cause considerable consequential damages.
- ▶ A damaged power cable should only be replaced by the manufacturer, its service agent or similarly qualified persons in order to avoid a hazard.

Troubleshooting with display code

Code	Cause	Solution
F2	Drain pump error.	Contact the customer service.
F3 I F32	The condenser thermal sensor is open-circuited or short-circuited.	Contact the customer service.
F4	Temperature of the laundry in the drum does not change.	Contact the customer service.
F5	Communication failure between PCB and display.	Contact the customer service.
L0	Temperature is too low.	Use the dryer when air temperature is higher than 5 °C.

Should the error codes reappear even after the taken measures, switch off the appliance, disconnect the power supply and contact the customer service.

Troubleshooting without display-codes

Problem	Possible cause	Possible solution
Tumble dryer fails to operate.	<ul style="list-style-type: none"> • Poor connection to the power supply. • Power failure. • No drying program is set. • Device has not been switched on. • The water tank is full. • The door is not closed properly. 	<ul style="list-style-type: none"> • Check connection to the power supply. • Check the power supply. • Set a drying program. • Switch the device on. • Empty the water tank. • Close the door properly.
Tumble dryer fails to operate and the display shows End .	<ul style="list-style-type: none"> • The laundry has reached the dry level defined by the programme? • There is no laundry in the drum? 	<ul style="list-style-type: none"> • Check if the program setting is appropriate. • Check if there is laundry in the drum.
Drying time is too long and the results are not satisfactory	<ul style="list-style-type: none"> • The programme setting is not correct. • The filter is clogged. • The evaporator is blocked. • The tumble dryer is overloaded. • The laundry is too wet. • The vent duct is blocked. 	<ul style="list-style-type: none"> • Make sure the program is set correctly. • Clean the filter screen. • Clean the evaporator. • Reduce the amount of laundry. • Spin the laundry properly before drying. • Check the vent duct and unblock it.
Remaining time on the display-stops or skips.	<p>The remaining time will be adjusted continuously based upon the following factors:</p> <ul style="list-style-type: none"> • Type of laundry. • Loaded amount. • Moisture degree of the laundry. • Ambient temperature. 	The automatic adjustment is a normal operation.

11.1 Preparation

- ▶ Remove all packaging material. While opening the package, water drops may be seen. This normal phenomenon results from water tests in the factory.
- ▶ Remove all packaging material including the polystyrene base.



Notice

Dispose of the packaging in an environmentally friendly manner. For information referring current disposal routes, consult your retailer or the local authorities.



WARNING!

Following transportation and installation, you **MUST** leave the dryer to stand for two hours before use.

11.2 Transport and waiting time

Transport the appliance in horizontal position only. To the maintenance-free lubrication oil is located in the capsule of the compressor. This oil can get through the closed pipe system during slanting transport. Before connecting the appliance to the power supply you have to wait 2 hours so that the oil runs back into the capsule.

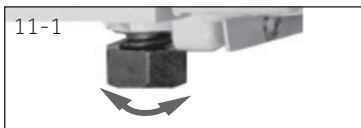

11.3 Aligning the appliance

The appliance should be placed on a flat and solid surface. Set the feet to the desired level (Fig. 11-1).

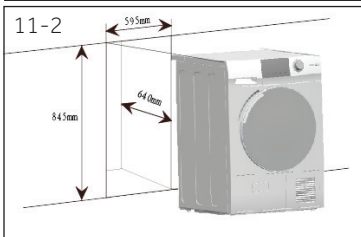

11.4 Installation under worktop

The dimensions of the recess should at least agree with the dimensions (Fig. 11-2).

1. Put the appliance adjacent to the slot. Make sure that all connections are easily accessible and functional.
2. Adjust accurately all feet to get a firm level position.
3. Install the appliance prudently into the recess.
4. Pay attention to sufficient ventilation.



11.5 Electrical connection

Before each connection check if:

- ▶ power supply, socket and fusing are appropriate to the rating plate.
- ▶ the power socket is earthed and no multi-plug or extension.
- ▶ the power plug and socket are strictly according.
- ▶ **Only UK:** The UK plug meets BS1363A standard

Put the plug into the socket. (Fig. 11-3).



WARNING!

If the supply cord is damaged, it must be replaced by the service agent (see warranty card) in order to avoid a hazard!

11.6 Reversing the door swing (Only for 8/9kg models)

- ▶ Before you start, unplug the dryer from its electrical outlet.
- ▶ Handle parts carefully to avoid scratching paint.
- ▶ Provide a non-scratching work surface for the doors.
- ▶ Tools you will need: Phillips-head screwdriver.
- ▶ Once you begin, do not move the cabinet until door-swing reversal is completed.
- ▶ These instructions are for changing the hinges from the right side to the left side. If you ever want to switch them back to the right side, follow these same instructions and reverse all references to the left and right.

1. Remove the door assembly

Open the door. Remove the two screws holding the hinge/door assembly to the dryer. Carefully set the hinge/door assembly aside (Fig. 11-4).

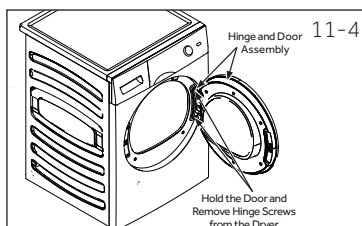

2. Remove, rotate and replace the inner door

Remove the eight stickers and screws securing the inner door to the outer door. Remove the inner door, rotate it 180° and reinstall it into the outer door using the same eight screws and stickers (Fig. 11-5).

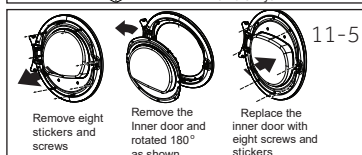

3. Remove, rotate and replace the door lock & strike plate

Remove the two screws holding the strike plate, and then remove one screw of the door lock, push down and take out the lock rotated 180° and install it on the opposite side. the same eight screws and stickers (Fig. 11-6).

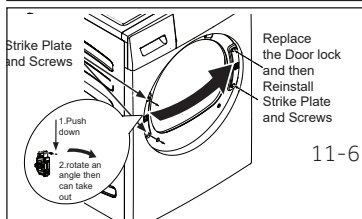

4. Rotate and replace the hinge/door assembly

Remove the two screws holding the strike plate, and then remove one screw of the door lock, push down and take out the lock rotated 180° and install it on the opposite side. the same eight screws and stickers (Fig. 11-7).

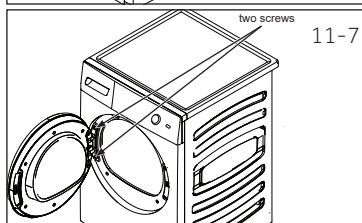

11.7 Wash-dryer stack

The arrangement to a space saving wash-dryer stack is possible (Fig. 11-8). Not every washing machine is suitable for this purpose. Information, as well as the corresponding mounting kit are available via your local dealer.

The mounting instructions supplied with the kit carefully inform about the installation steps.

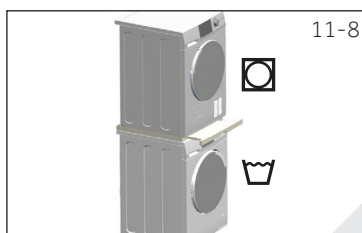

Productfiche (acc. to EU 392/2012)

Trade mark	Haier			
Model identifier	HD90-A2979	HD100-A2979	HD80-A3979	HD90A3979 HD90-A3979S HD90-A3S979
Rated capacity (kg)	9	10	8	9
Kind of tumble drier	Condenser			
Energy efficiency class	A++	A++	A+++	A+++
Weighted Annual Energy Consumption (AEC _c in kWh/year) ¹⁾	236	280	175	193
Tumble dryer with or without automatic	with automatic			
Energy consumption of the standard cotton programme ³⁾ at full load (kWh/cycle)	1.98	2.29	1.43	1.58
Energy consumption of the standard cotton programme ³⁾ at partial load (kWh/cycle)	1.17	1.35	0.85	0.93
Power consumption of the off-mode (W)	0.1	0.1	0.1	0.1
Power consumption of the left-on mode (W)	1.19	1.19	1.19	1.19
Duration of the „left-on mode“ (min) ²⁾	40			
Standard drying programme ³⁾	Cotton			
Weighted programme time of the standard drying programme ³⁾ at full and partial load (min)	208	220	215	243
Programme time of the standard cotton programme ³⁾ at full load (min)	269	280	273	298
Programme time of the standard cotton programme ³⁾ at partial load (min)	162	175	168	182
Condensation efficiency class ⁴⁾	B	B	B	B
Weighted condensation efficiency for the standard cotton programme ³⁾ at full and partial load (%)	80	80	80	80
Average condensation efficiency of the standard cotton programme ³⁾ at full load	80	80	80	80
Average condensation efficiency of the standard cotton programme ³⁾ at partial load	80	80	80	80
Weighted sound power level of the standard cotton programme ³⁾ at full load (dB)	67			
Built-in or freestanding	Freestanding/ built under			

- 1) Based on 160 drying cycles of the standard cotton programme at full and partial load, and the consumption of the low-power modes. Actual energy consumption per cycle will depend on how the appliance is used.
- 2) In case there is a power management system.
- 3) This programme used at full and partial load is the standard drying programme to which the information in the label and the fiche relates to. This is the programme suitable for drying normal wet cotton laundry and it is the most efficient programme in terms of energy consumption for cotton.
- 4) Class G is the least efficient and Class A is the most efficient.

Additional data

Dimensions - HxDxW in mm	845 x 650 x 595
Power supply (refer to rating plate) - voltage / current / input	220-240 V~50 Hz/ 2.4A/ 550 W
Permissible ambient temperature	5°C to 35°C
Fluorinated greenhouse gas	HFC-134a
Volume	0.26 kg
GWP	1430
Tonne(s) of CO ₂ equivalent	0.6

Electric circuit diagram HD90-A2979:

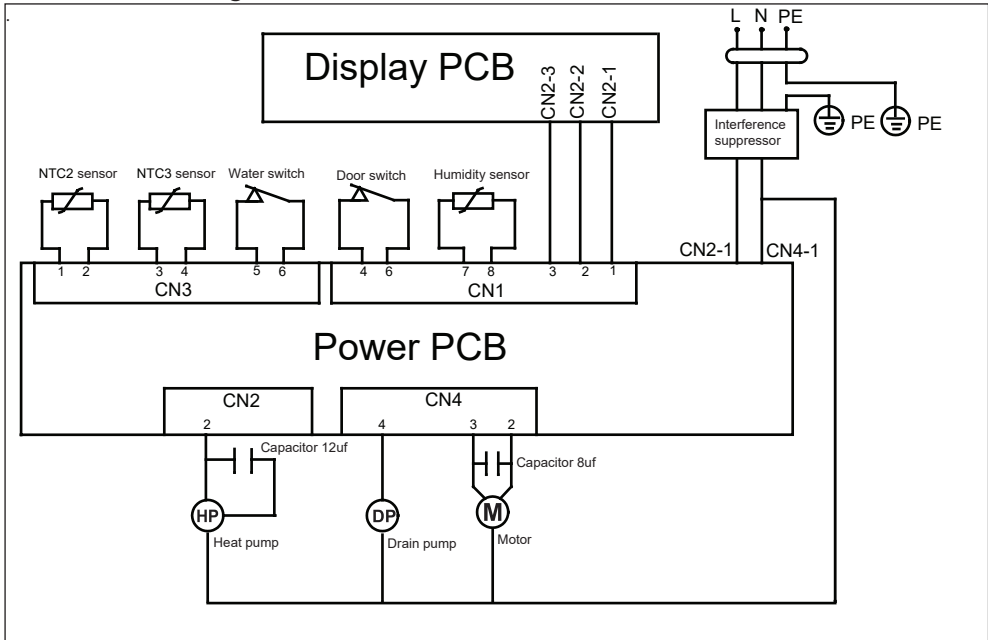

Electric circuit diagram HD100-A2979:

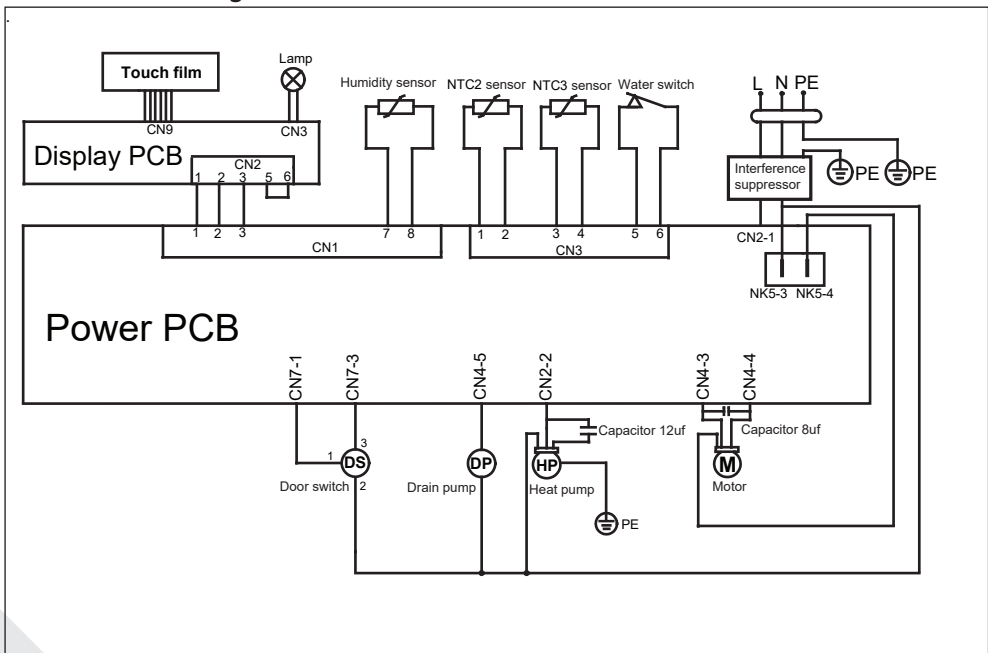

Electric circuit diagram HD80-A3979/HD90-A3979/HD90-A3979S/HD90-A3S979:

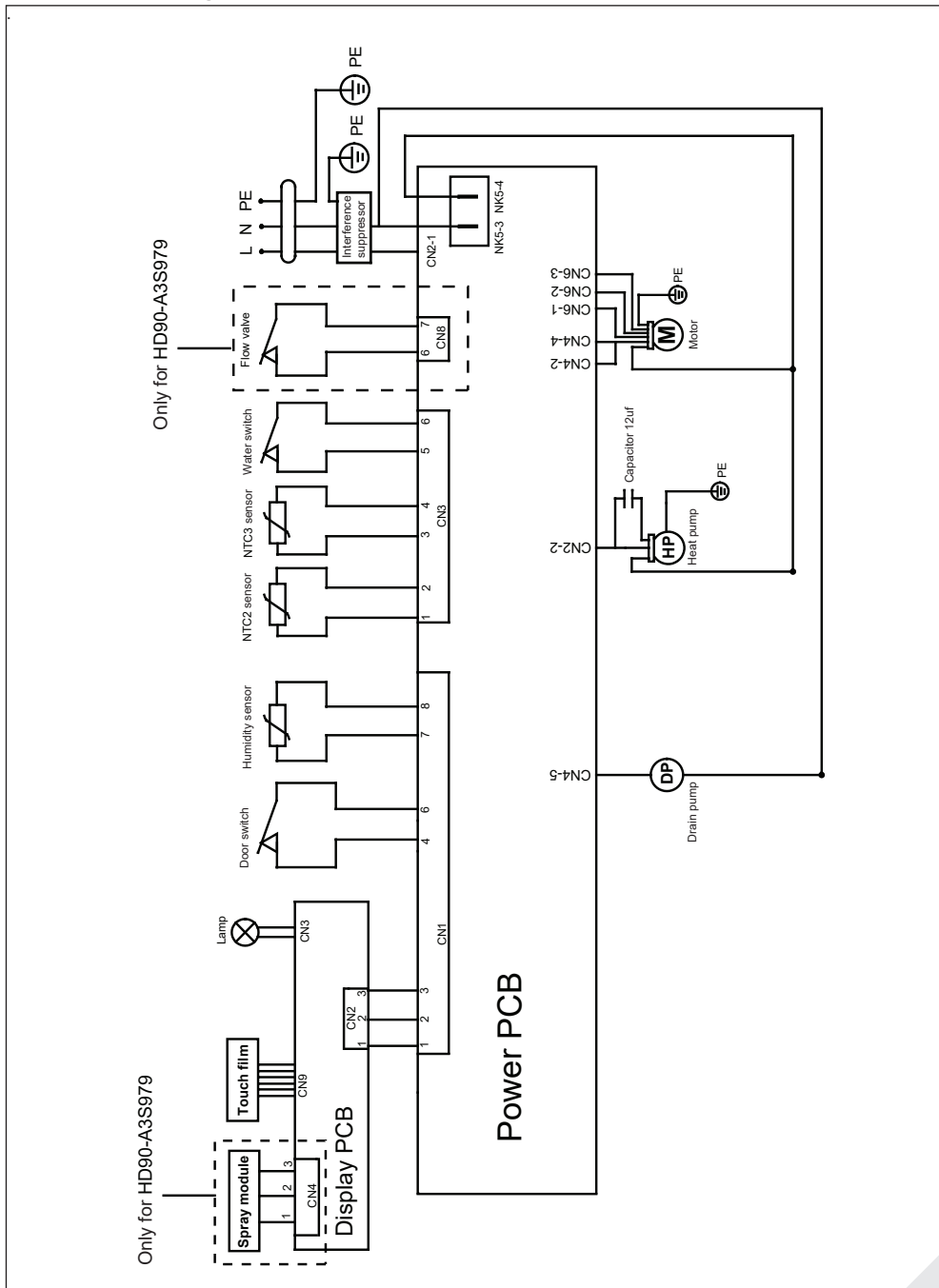

We recommend our Haier Customer Service and the use of original spare parts.
If you have a problem with your appliance, please first check section TROUBLESHOOTING.

If you cannot find a solution there, please contact

- ▶ your local dealer or
- ▶ the Service & Support area at www.haier.com where you can find telephone numbers and FAQs and where you can activate the service claim.

To contact our Service, ensure that you have the following data available.
The information can be found on the rating plate.

Model _____ Serial No. _____

Also check the Warranty Card supplied with the product in case of warranty.

For general business enquiries please find below our addresses in Europe:

European Haier addresses			
Country*	Postal address	Country*	Postal address
Italy	Haier Europe Trading SRL Via De Cristoforis, 12 21100 Verese ITALY	France	Haier France SAS 53 Boulevard Ornano – Pleyad 3 93200 Saint Denis FRANCE
Spain Portugal	Haier Iberia SL Pg. Garcia Faria, 49-51 08019 Barcelona SPAIN	Belgium-FR Belgium-NL Netherlands Luxembourg	Haier Benelux SA Anderlecht Route de Lennik 451 BELGIUM
Germany Austria	Haier Deutschland GmbH Konrad-Zuse-Platz 6 81829 München GERMANY	Poland Czechia Hungary Greece Romania Russia	Haier Poland Sp. zo.o. Al. Jerozolimskie 181B 02-222 Warszawa POLAND
United Kingdom	Haier Appliances UK Co.Ltd. One Crown Square Church Street East Woking, Surrey, GU21 6HR UK		

*For more information please refer to www.haier.com

HD90-A2979/HD100-A2979/HD80-A3979/HD90-A3979/HD90-A3979S/HD90-A3S979

Haier