

XYLO TV Unit

habitat 

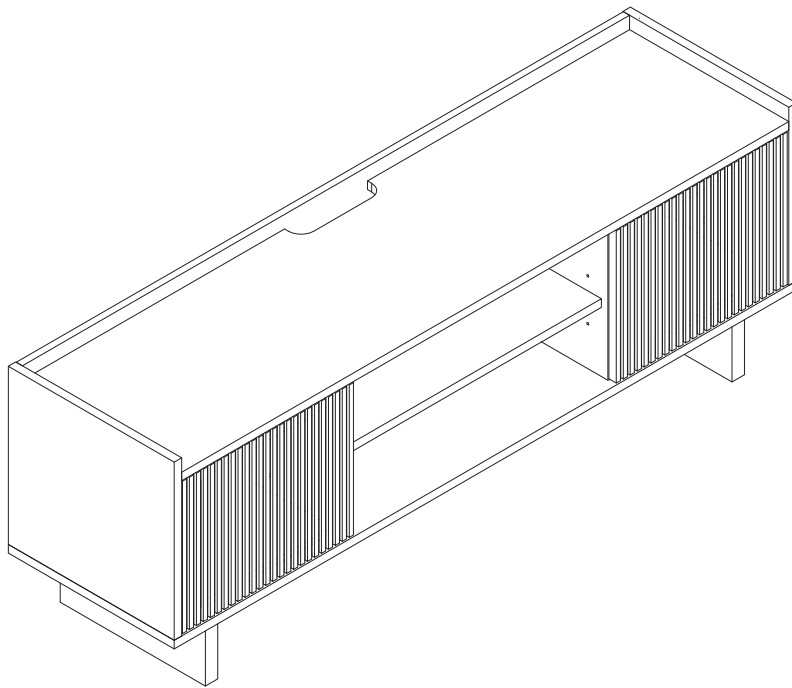

Spare Parts

 www.argos-support.co.uk

 Help@ClickSpares.co.uk

 0370 112 1928

Customer Support

 0345 640 2020



Safety and Care Advice

Product Details

Xylo Dark Stained Ash TV Unit 1304891

IMPORTANT, RETAIN FOR FUTURE REFERENCE: READ CAREFULLY.

- Keep children and animals away from the work area, small parts could choke if swallowed.
- Assemble the item as close to its final position (in the same room) as possible.
- Assemble on a soft level surface to avoid damaging the unit or your floor.
- We do not recommend the use of power drill/drivers for inserting screws as this could damage the unit. Only use hand screwdrivers.
- Parts of the assembly will be easier with 2 people.
- Dispose of all packaging carefully and responsibly.

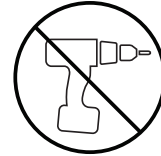

Care and maintenance

- Only clean using a damp cloth and mild detergent. Do not use abrasive cleaners.
- From time to time check that there are no loose screws, nuts or bolts. If there are please re-tighten.
- This product should not be discarded with household waste. Take to your local authority waste disposal centre.
- Use a dry cloth to clean the product, furniture polish is not recommended.

Additional Guidance

- Assemble all parts and bolts loosely during assembly, only once the product is complete should you fully tighten the bolts.
- Regularly check and ensure that all bolts and fittings are tightened properly.
- Maximum loading weight 50kg
- This product is compliant EN12521
- Any additional or replacement parts are obtained from the manufacturer.

Fittings (Shown to scale)

Bag 1

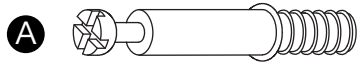

Metal Dowel x36



Locking Nut x36

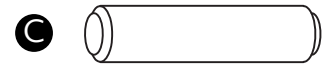

30mm Wooden Dowel x28

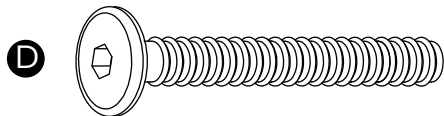

M6*50mm Bolt x 2

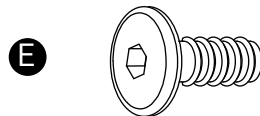

M6*16mm Bolt x 16

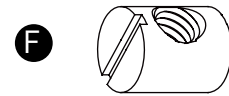

Ø10*15mm Nut x 2

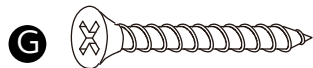

30mm Screw x 12



15mm Screw x 36

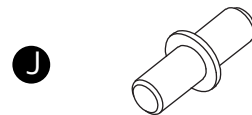

Shelf Support x4

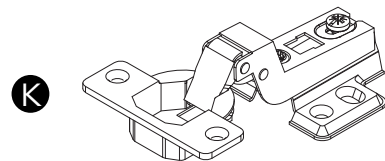

Hinge x 4

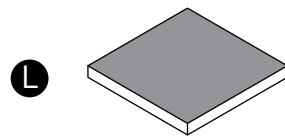

25x25mm Foot Pad x 4

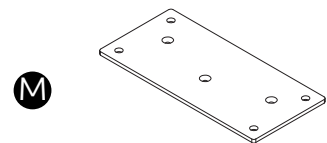

Iron Sheets x 4

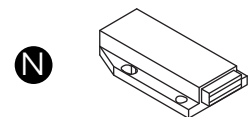

Magney Catch x2



Iron Sheet x 2



M4 Allen Key x 1

Tools required

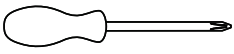

Phillips screwdriver
(small & medium)

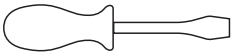

Phillips screwdriver
(small & medium)

Parts

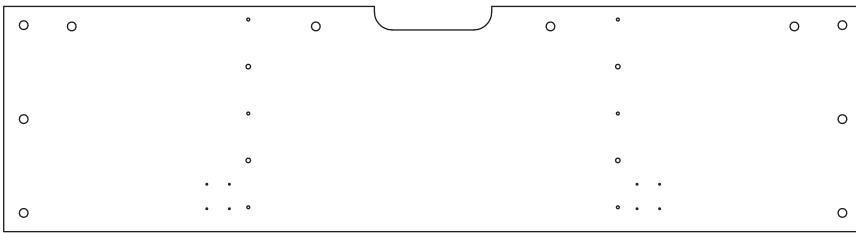

1 Top Panel x1
(1464 x 385mm)

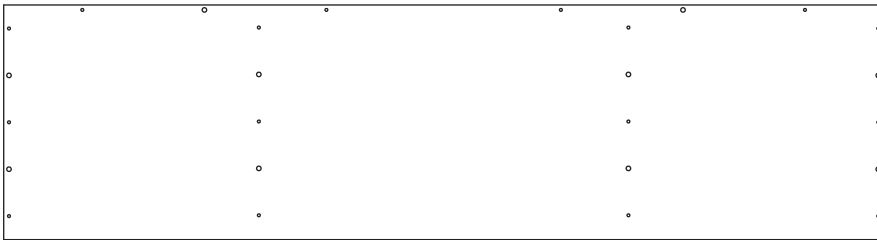

2 Bottom Panel x1
(1500 x 400mm)

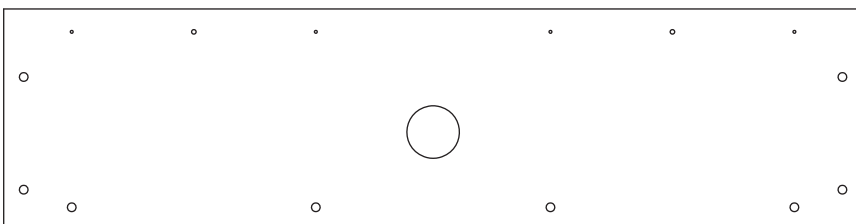

3 Back Panel x1
(1464 x 372mm)

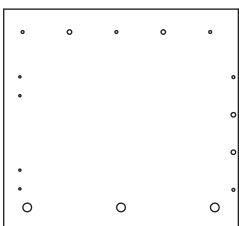

4 Left Side Panel x1
(400 x 372mm)

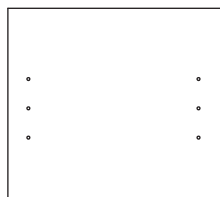

5 Middle Panel x2
(362 x 342mm)

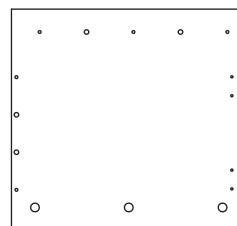

6 Right Side Panel x1
(400 x 372mm)

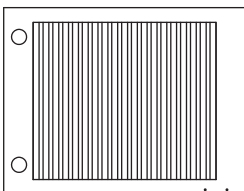

7 Left Door x1
(422 x 315mm)

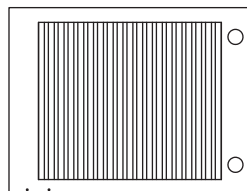

8 Right Door x1
(422 x 315mm)

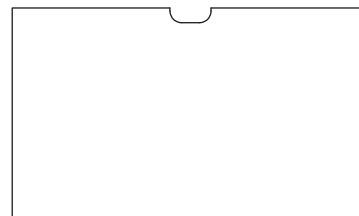

9 Shelf Panel x1
(608 x 360mm)



10 Left Leg Panel x1
(350 x 140mm)



11 Leg Rail x1
(1240 x 50mm)



12 Right Leg Panel x1
(350 x 140mm)

1

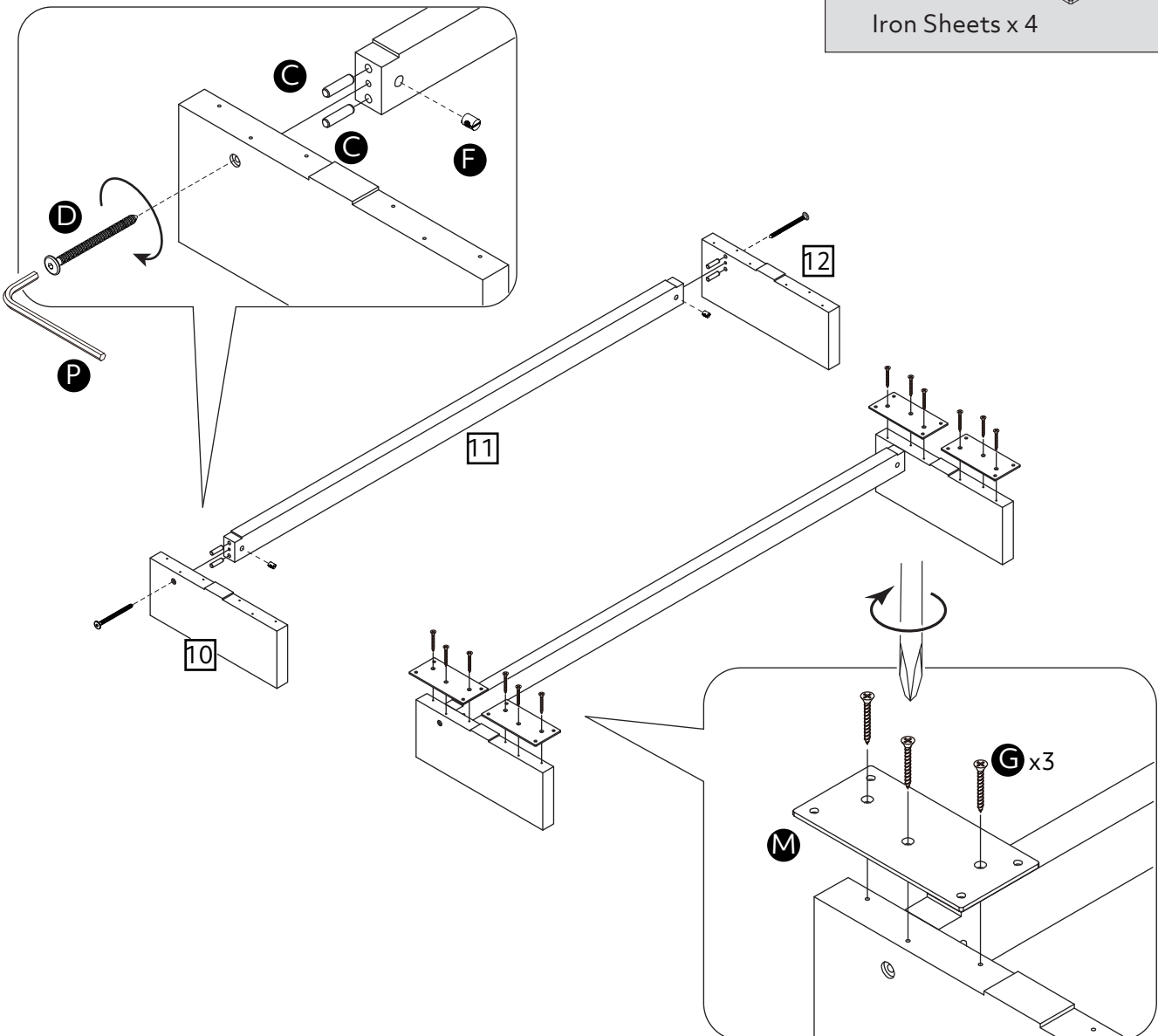
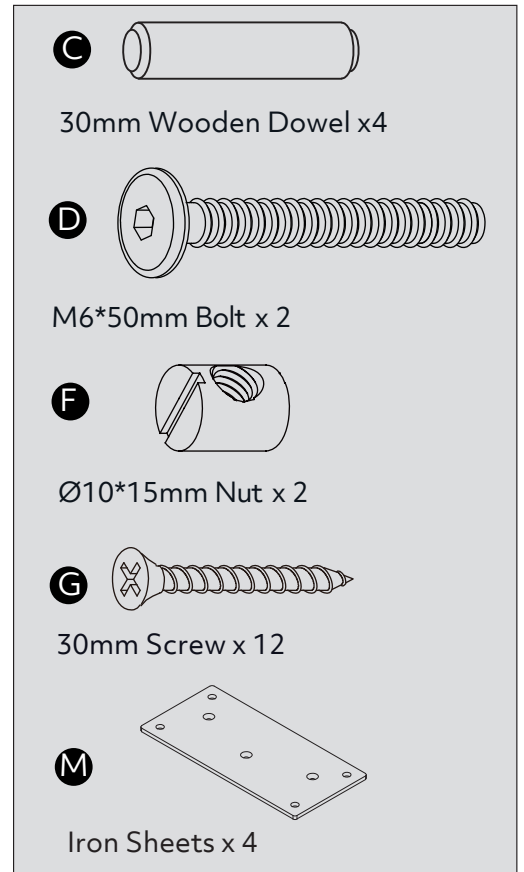
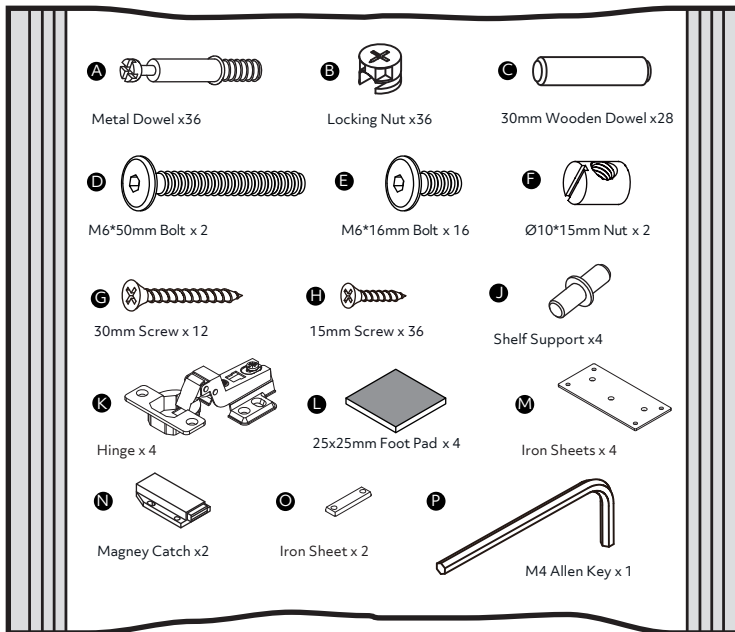

2

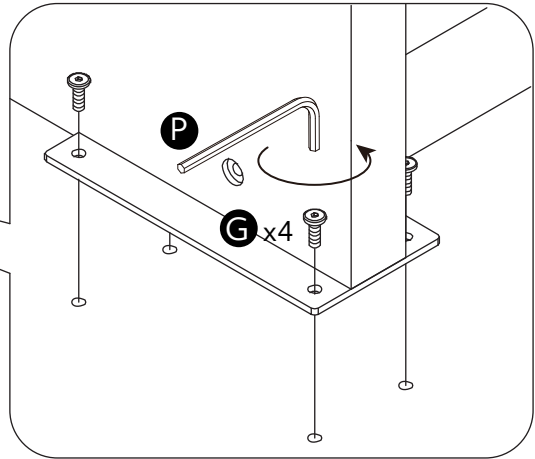
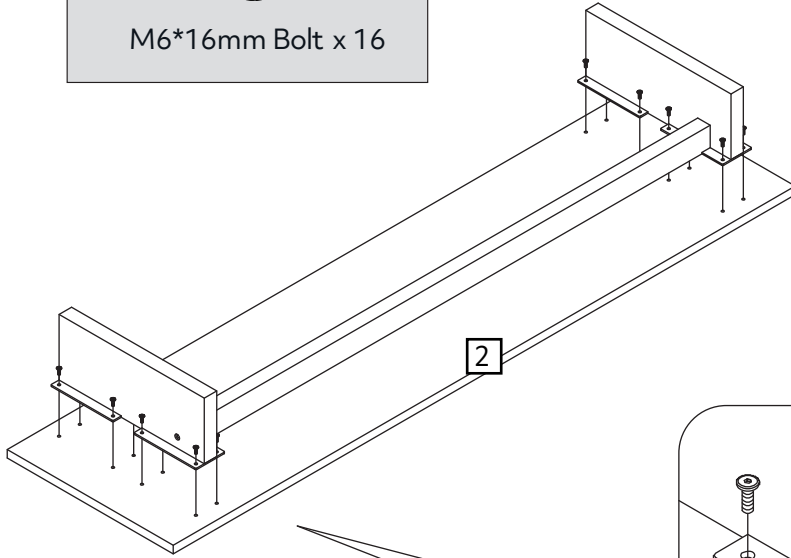
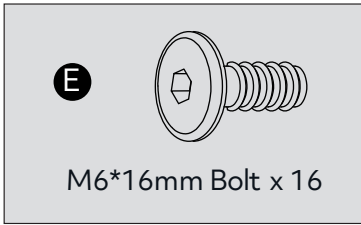

3

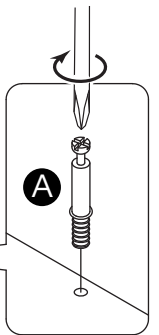
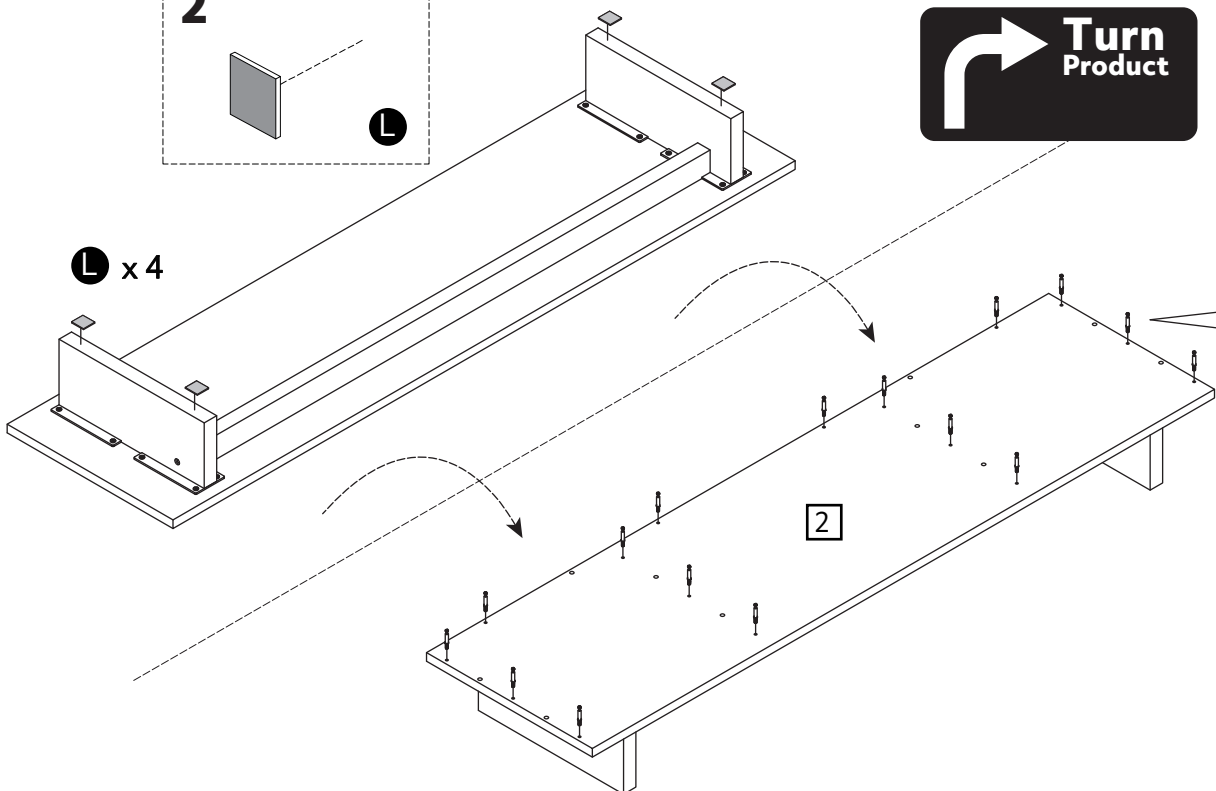
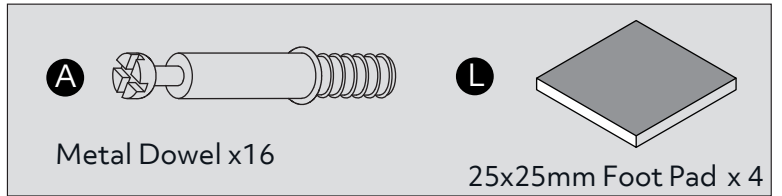
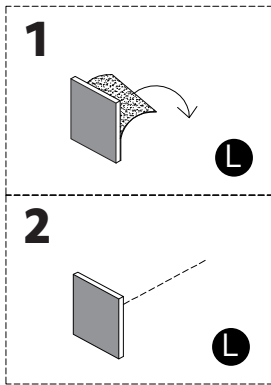

4

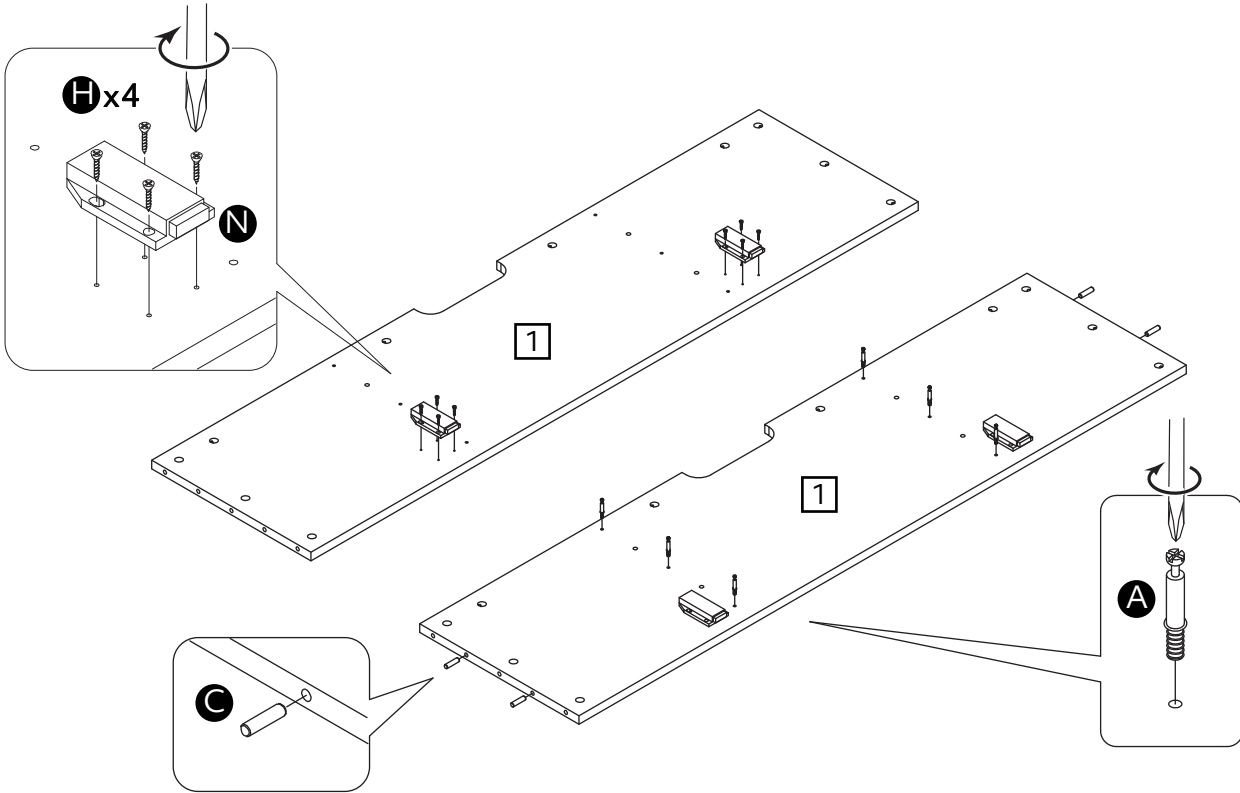
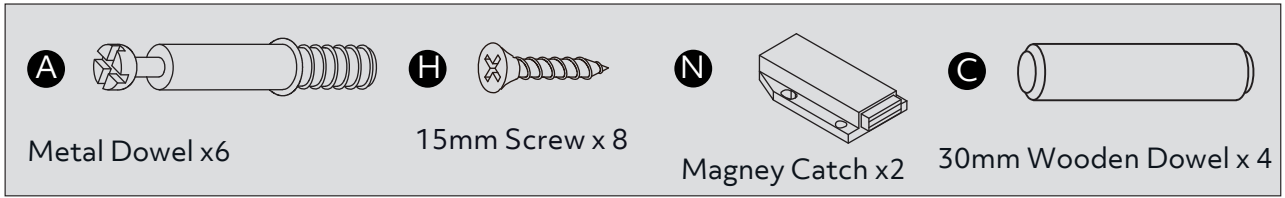

5

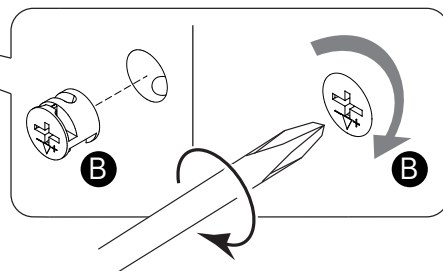
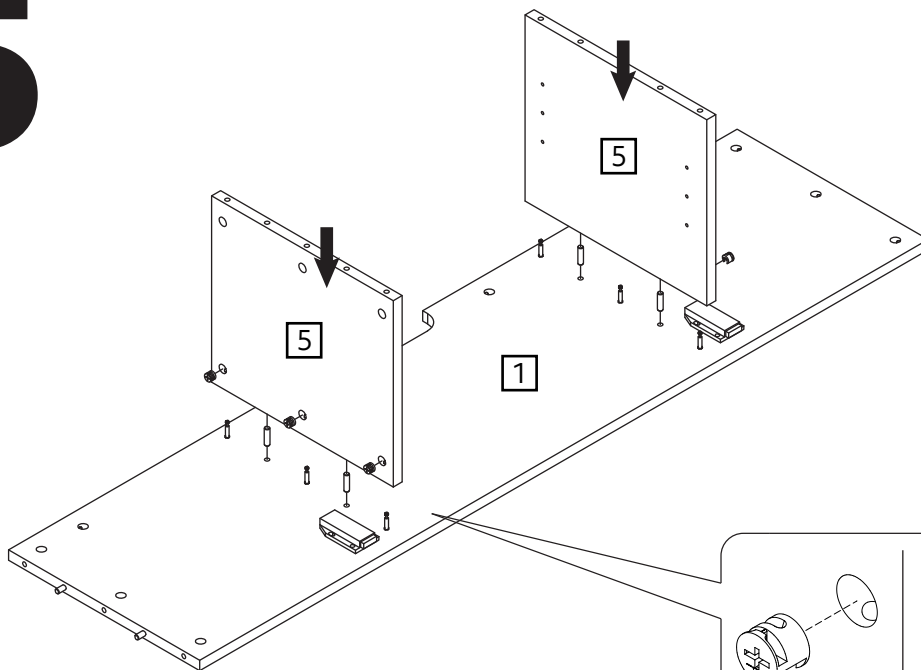
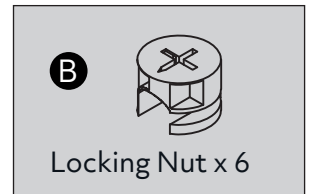

Warning!

Panels 5 and 6 look similar so please take care to identify each carefully otherwise you could mix them, Please assemble according to the illustration!

6

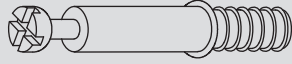
A  Metal Dowel x14

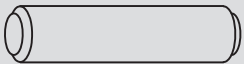
C  30mm Wooden Dowel x 4

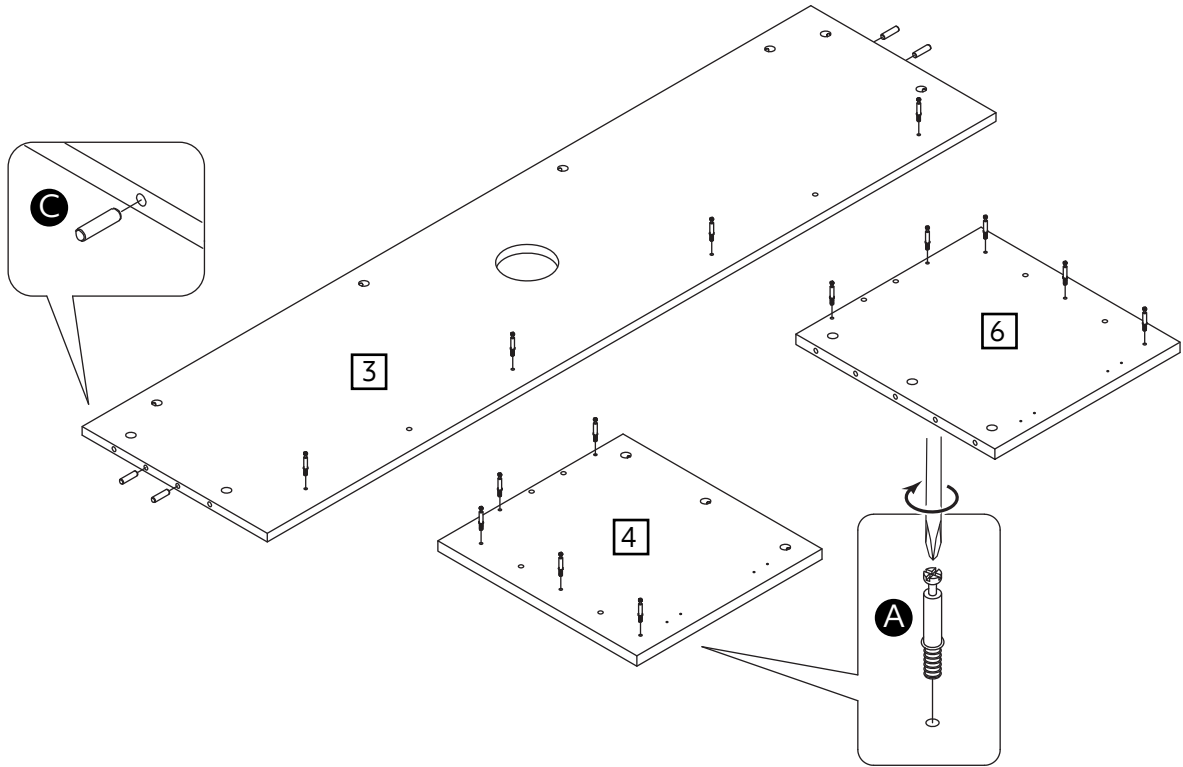

7

B  Locking Nut x 4

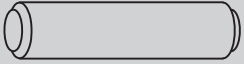
C  30mm Wooden Dowel x 2

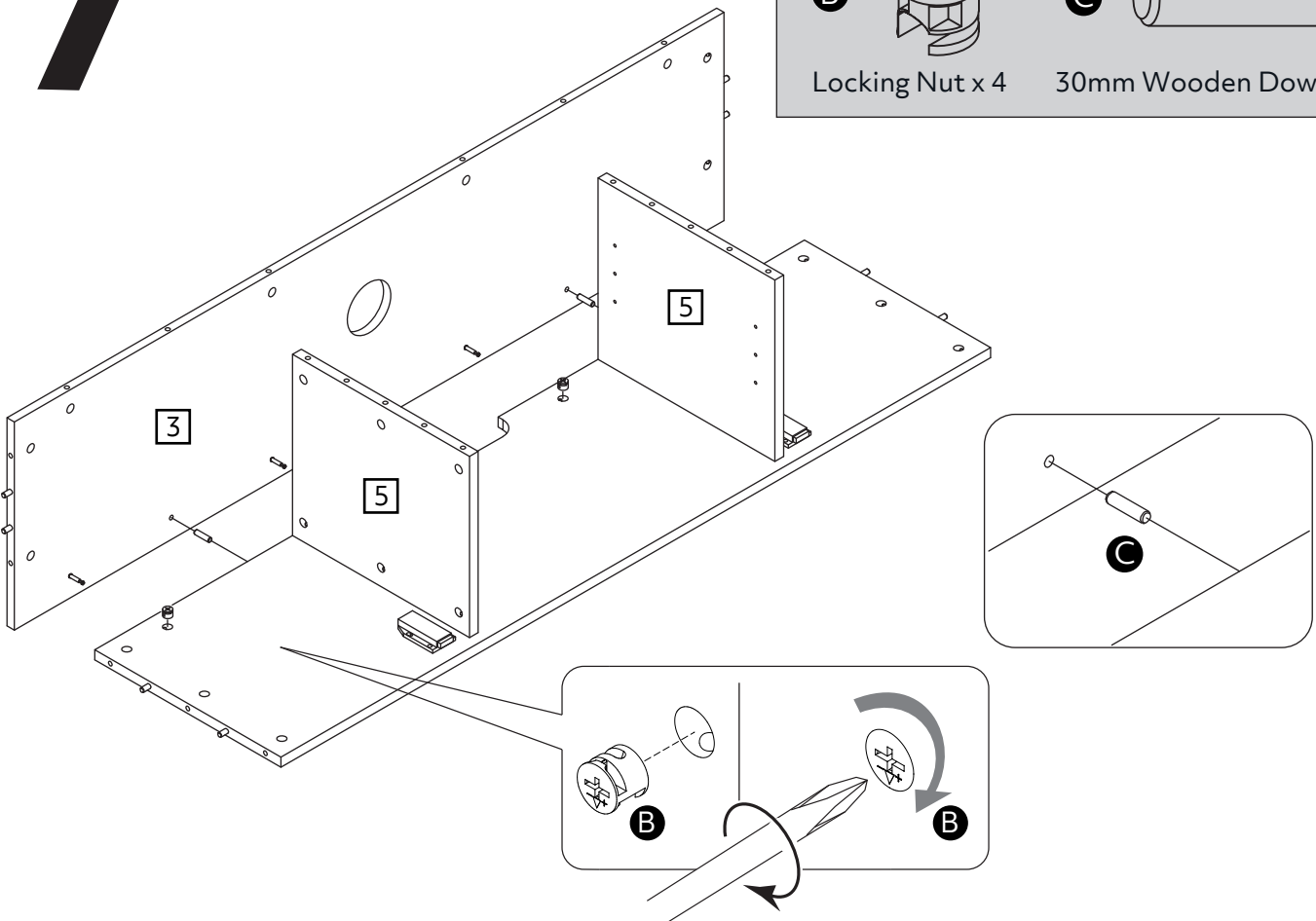

8

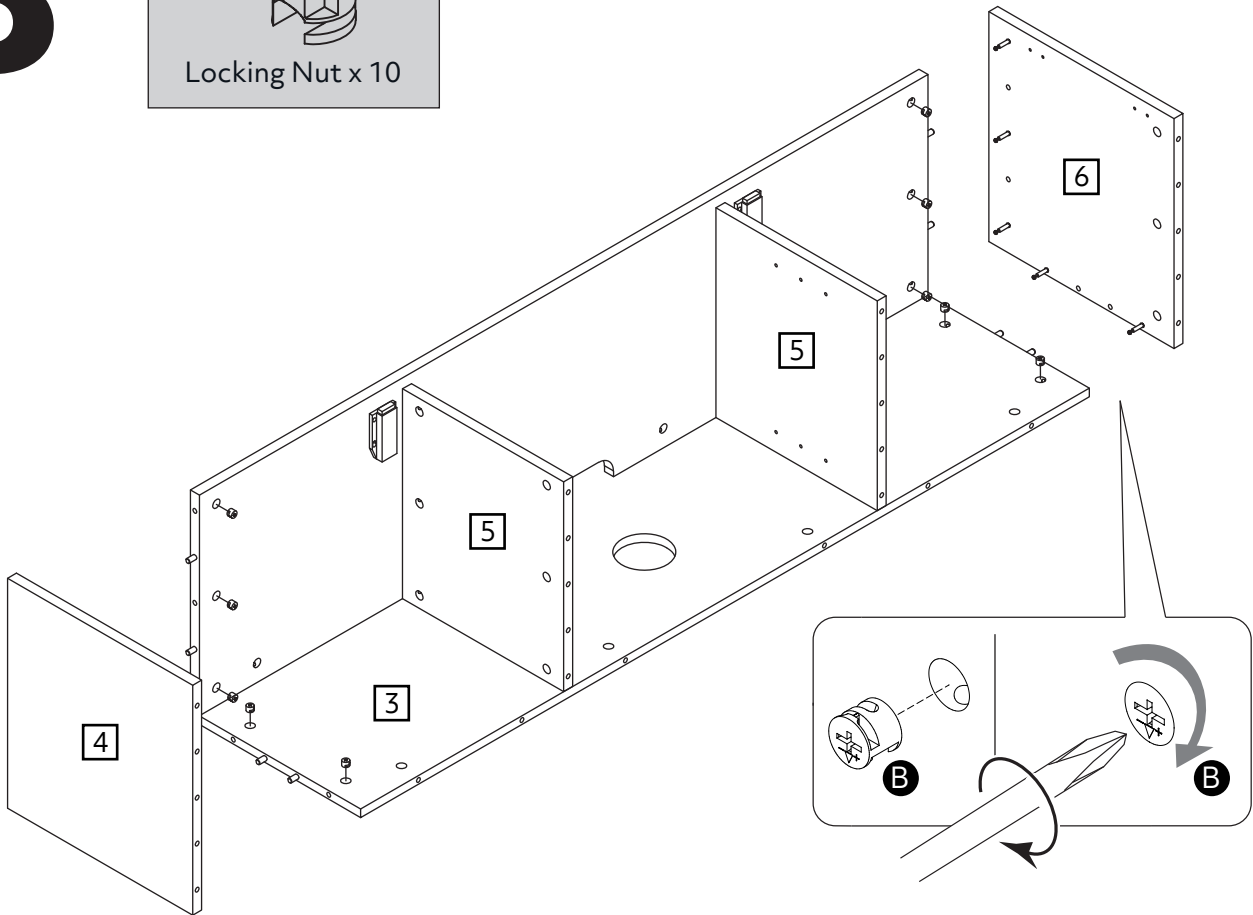
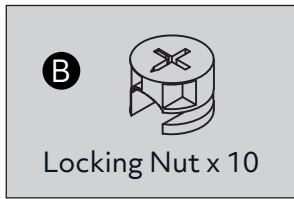

9

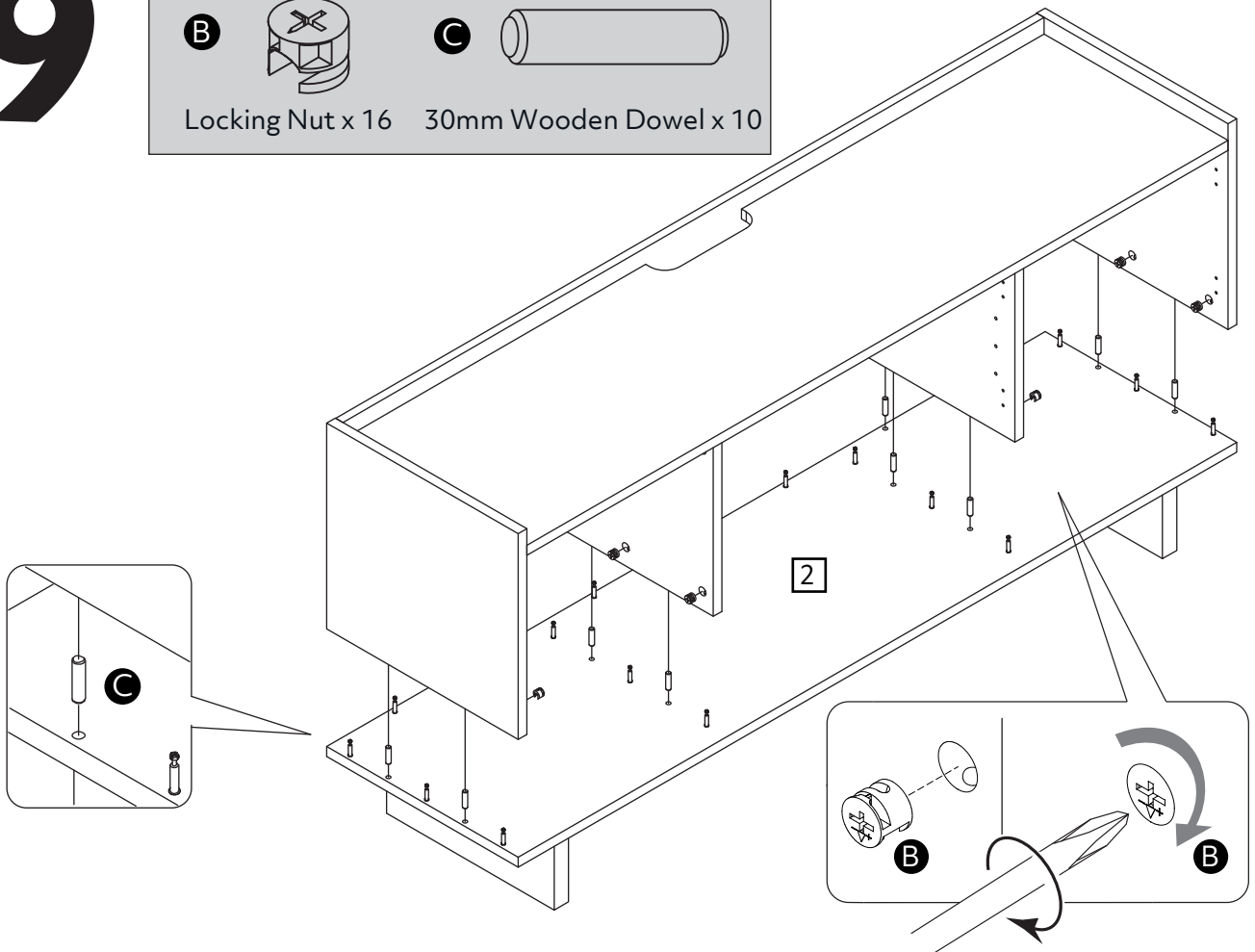
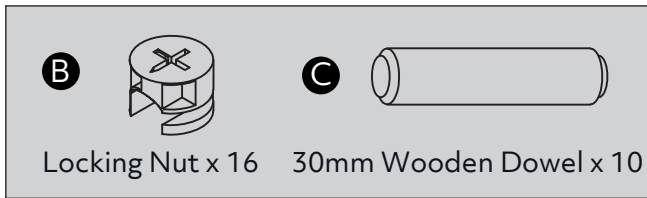

10



15mm Screw x 12



Iron Sheet x 2



Hinge x 4

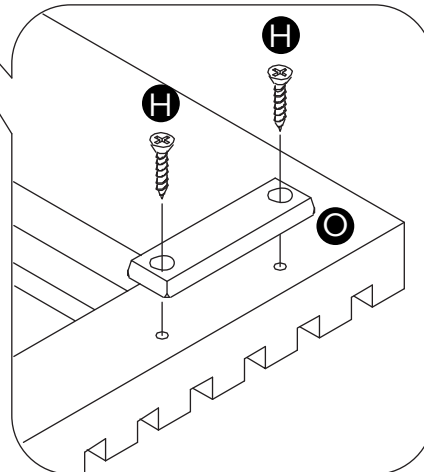
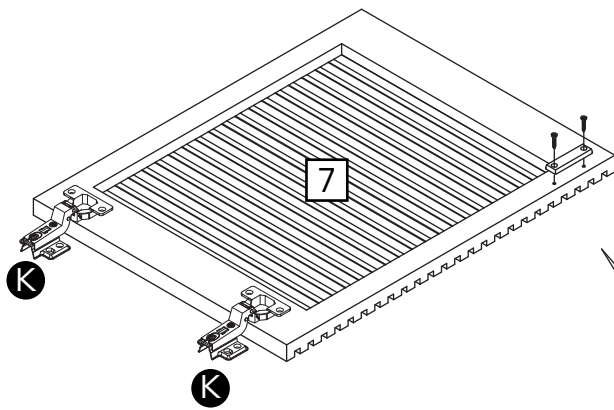
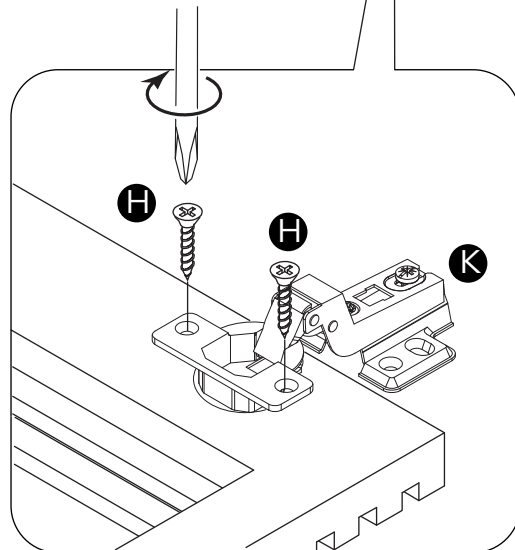
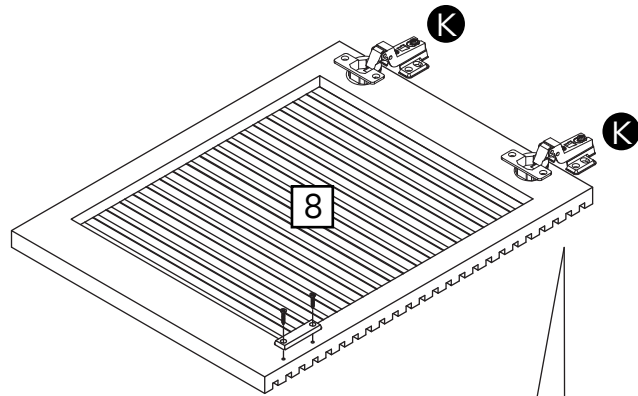
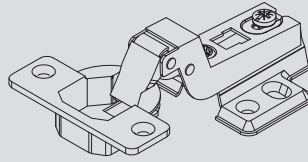

11



15mm Screw x 16

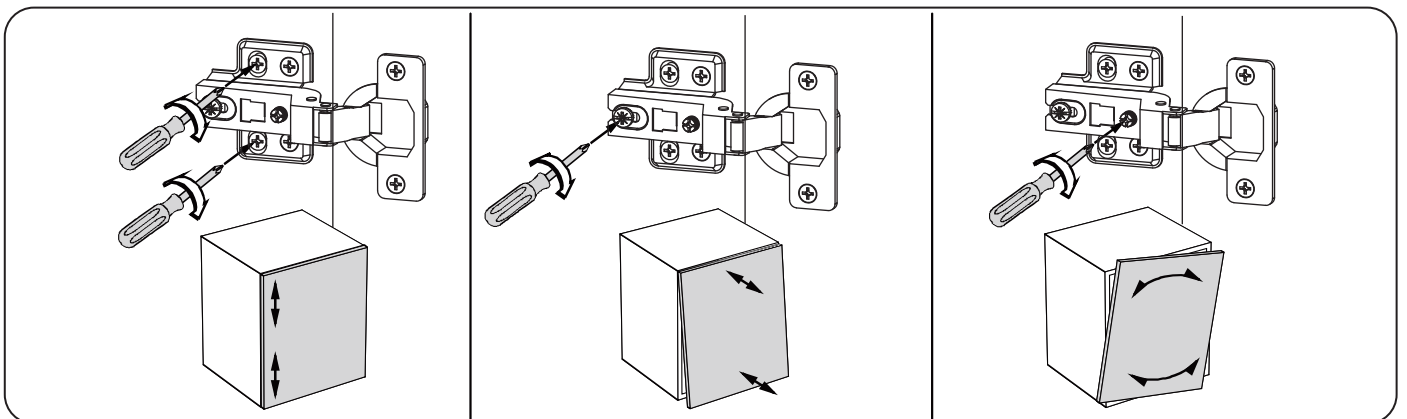
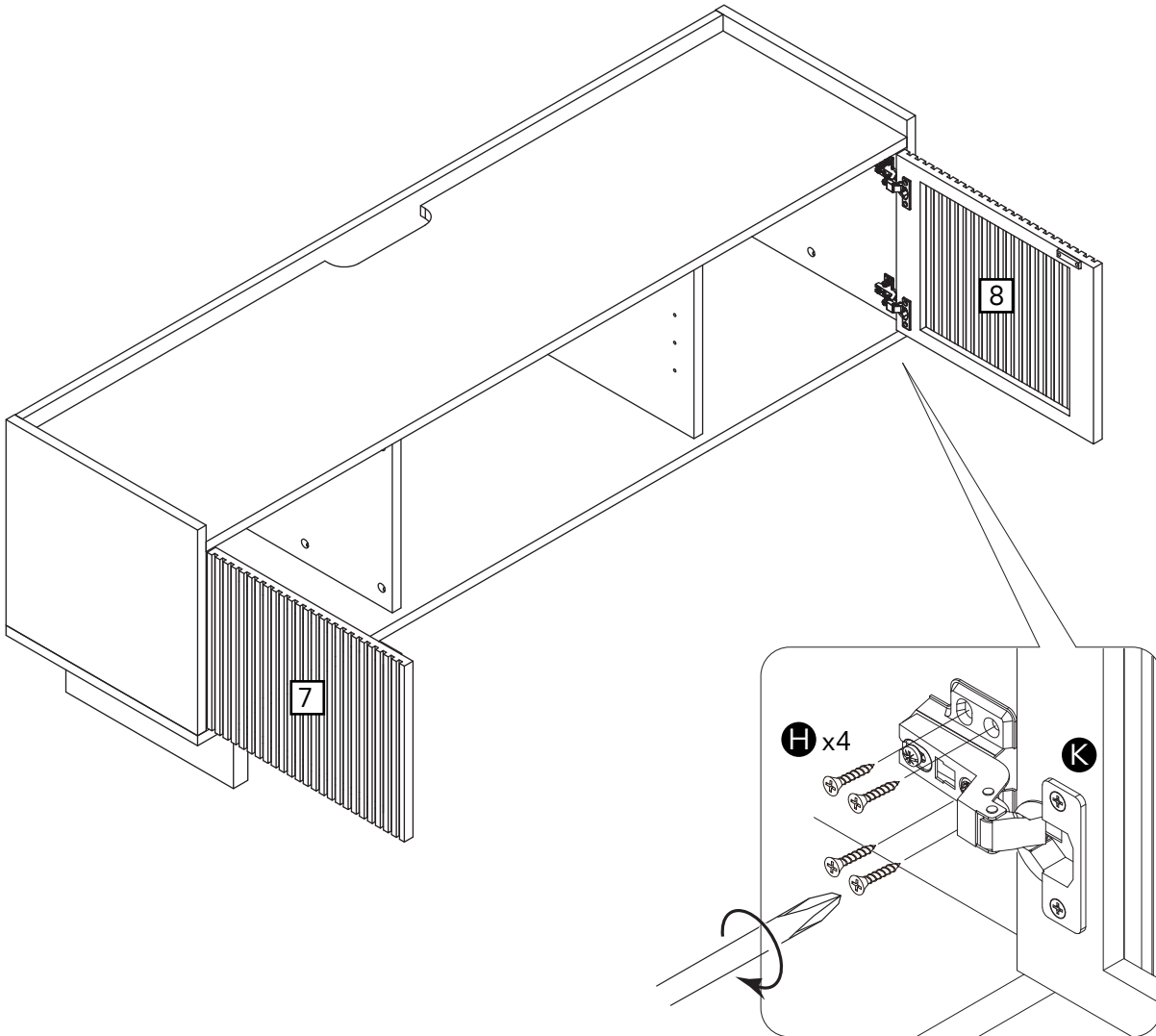

12

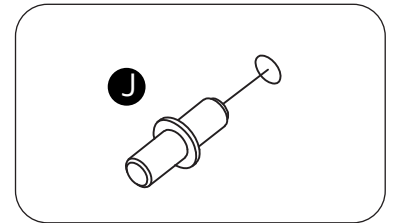
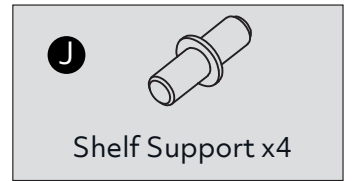
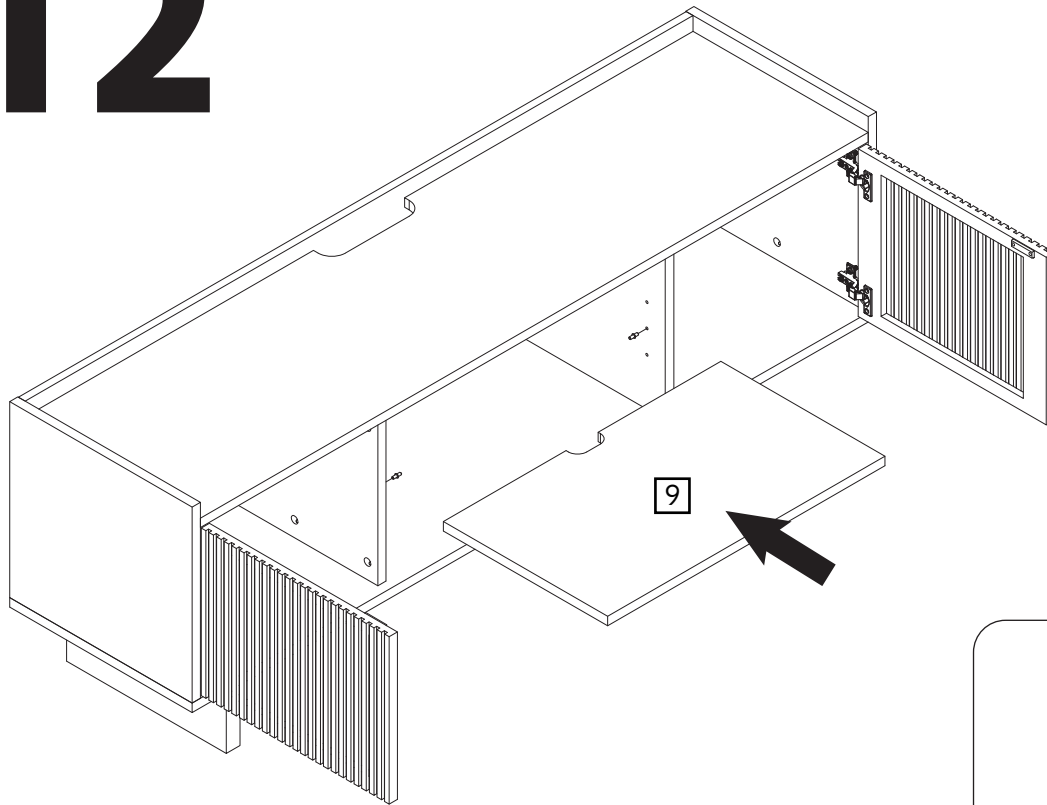

13

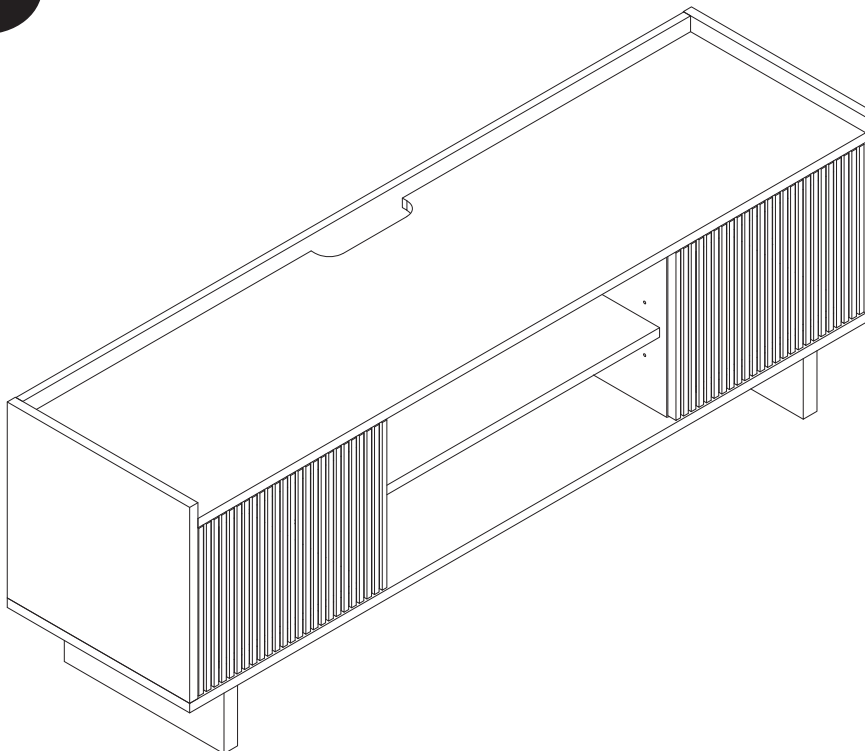

Assembly is complete.