



STAR WARS™

75346





LEGO.com/sustainable-packaging



BUILDER



Apple and the Apple logo are trademarks of Apple Inc., registered in the U.S. and other countries and regions. App Store is a service mark of Apple Inc. Google Play and the Google Play logo are trademarks of Google LLC. Tencent and the Tencent logo are trademarks of Tencent Inc.

Q [LEGO.com/devicecheck](https://www.lego.com/devicecheck)

EN Ask parents' permission before going online | **DE** Eltern um Erlaubnis bitten, bevor du online gehst | **FR** Demande l'autorisation d'un parent avant d'aller en ligne | **IT** Chiedi il permesso ai tuoi genitori prima di andare online | **ES** Pídeles permiso a tus papás antes de conectarte a Internet | **PT** Peça autorização aos pais antes de acederes online | **ZH** 上网前应先征得父母的同意 | **PL** Poproś rodziców o zgodę, zanim wejdiesz do Internetu | **CS** Než půjdeš na internet, požádej rodiče o svolení | **SK** Skôr než pôjdeš na internet, vypýtaj si povolenie od rodičov | **HU** Kérj szülői engedélyt, mielőtt online csatlakoznál! | **RO** Cere permisiunea părinților înainte de a te conecta online | **BG** Поискайте разрешение от родител, преди да влезете онлайн | **LV** Pirms došanās tiešsaistē palūdz atļauju vecākiem | **ET** Enne Interneti kasutamist küsi vanematelt luba | **LT** Prieš prisijungdami prie interneto, atsi klauskite tėvų

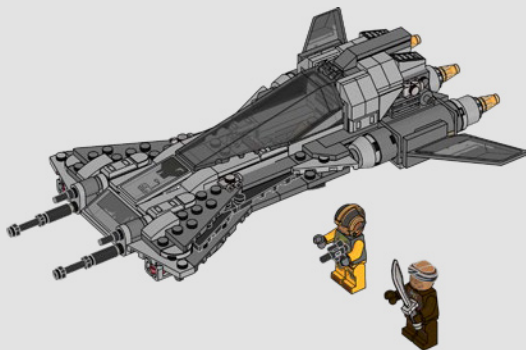
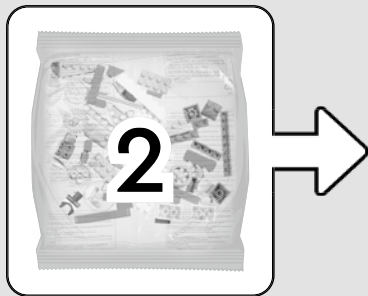
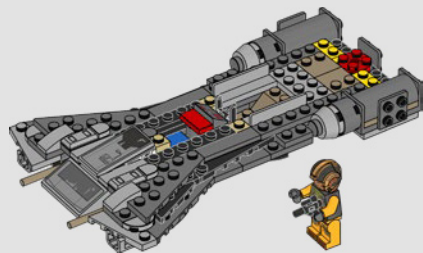
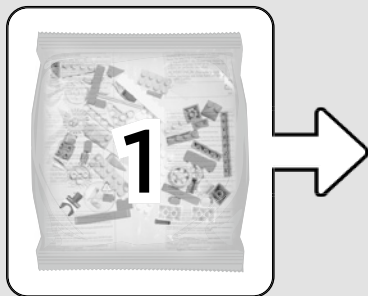

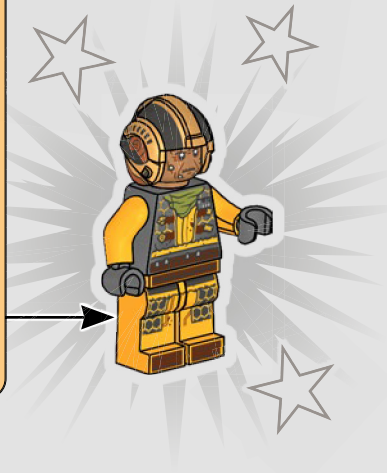
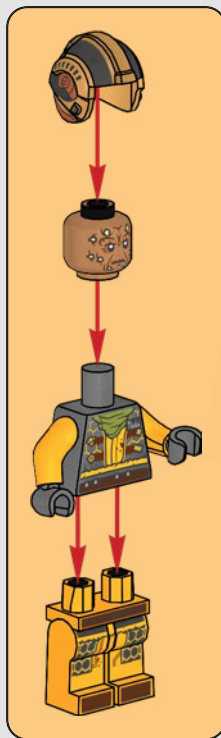

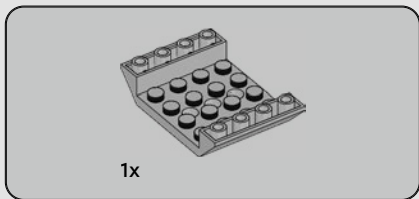
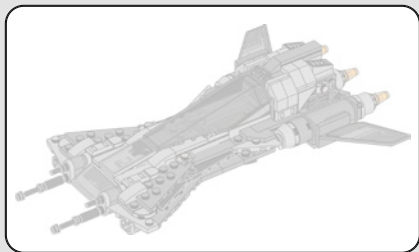

1

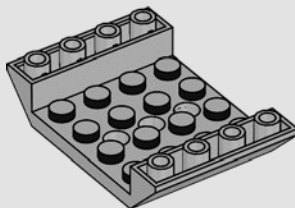

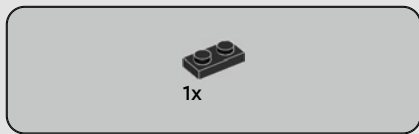

2

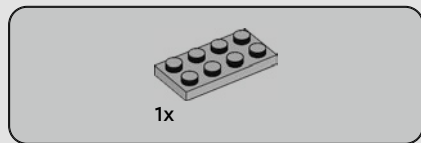
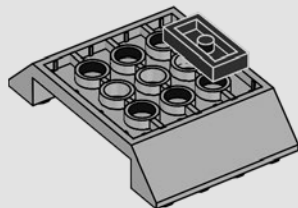

3

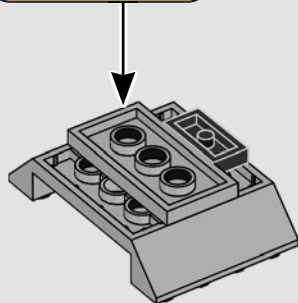
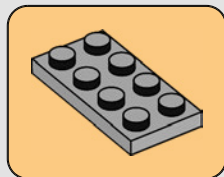

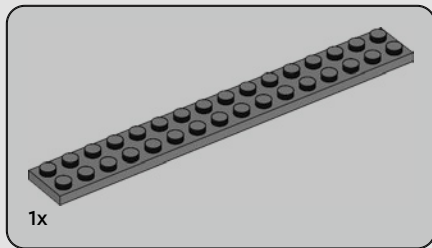

4

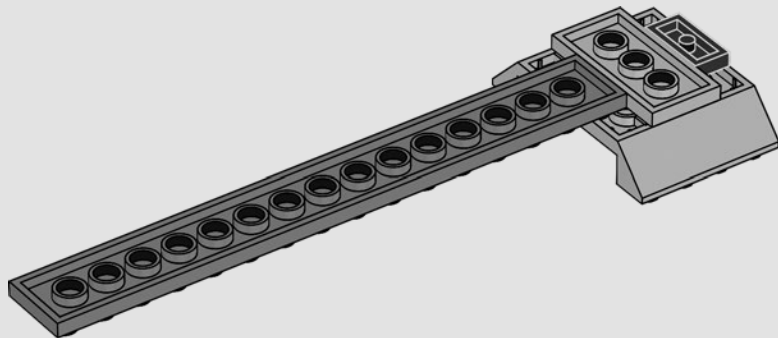



5

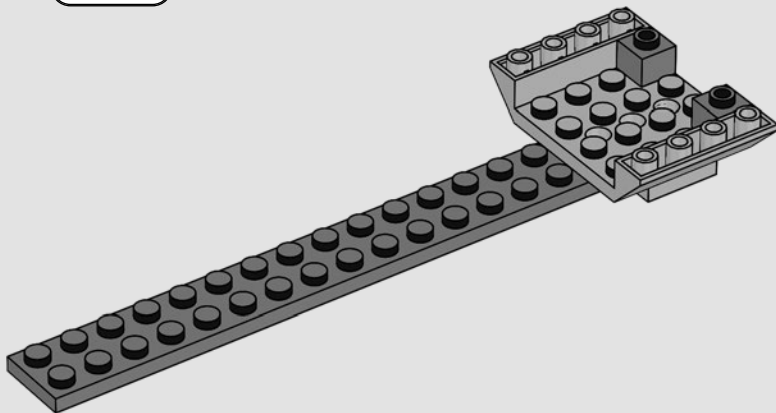
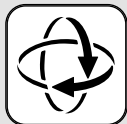

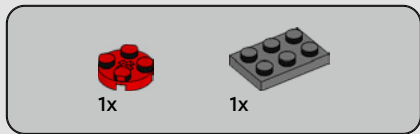

6

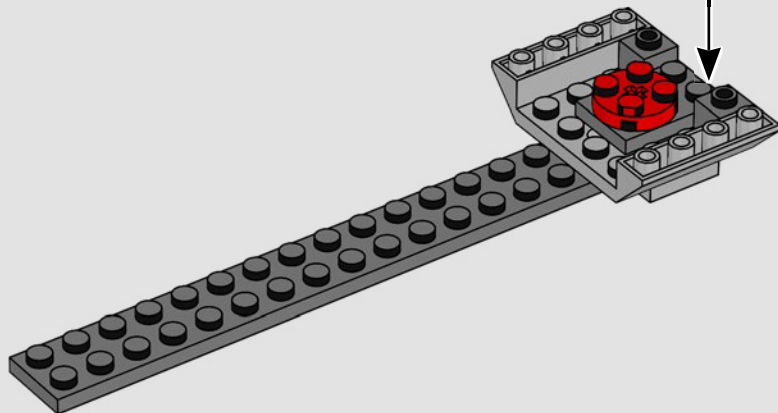
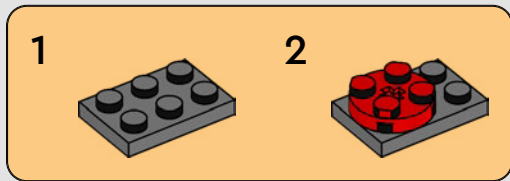

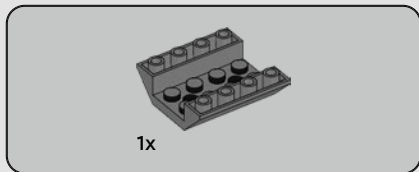

7

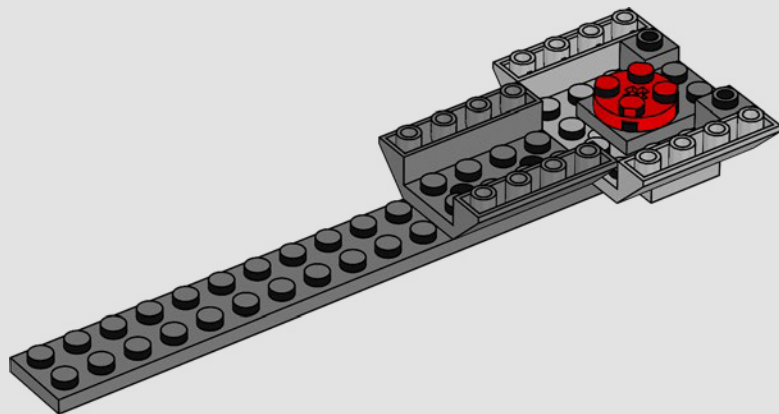



2x

8

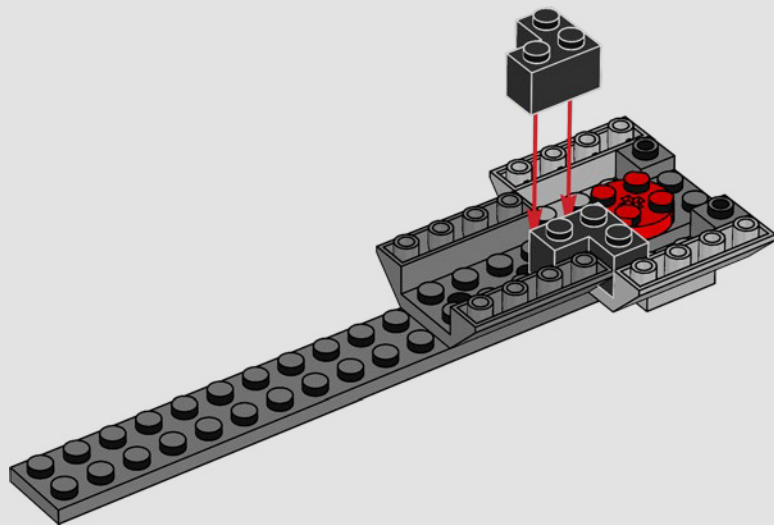

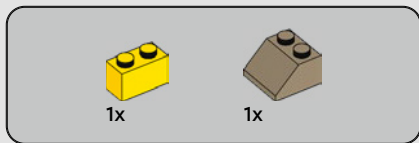

9

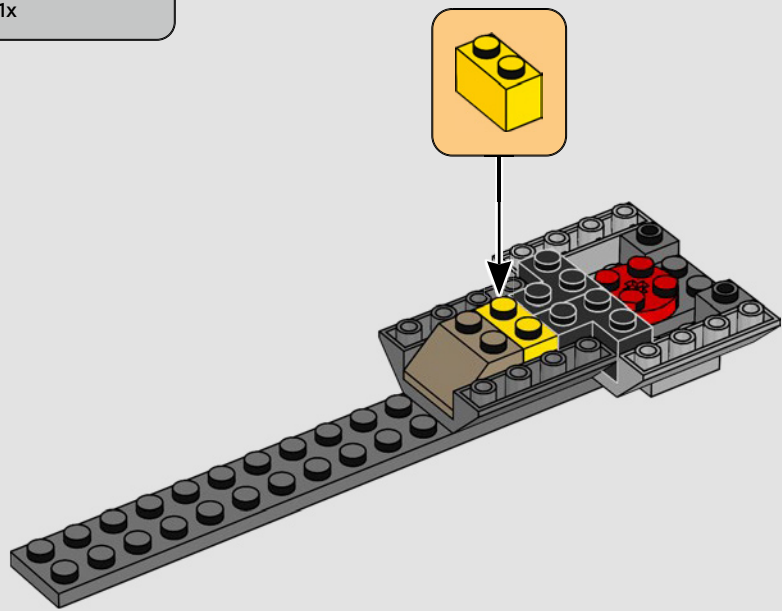



2x



2x

10



2x

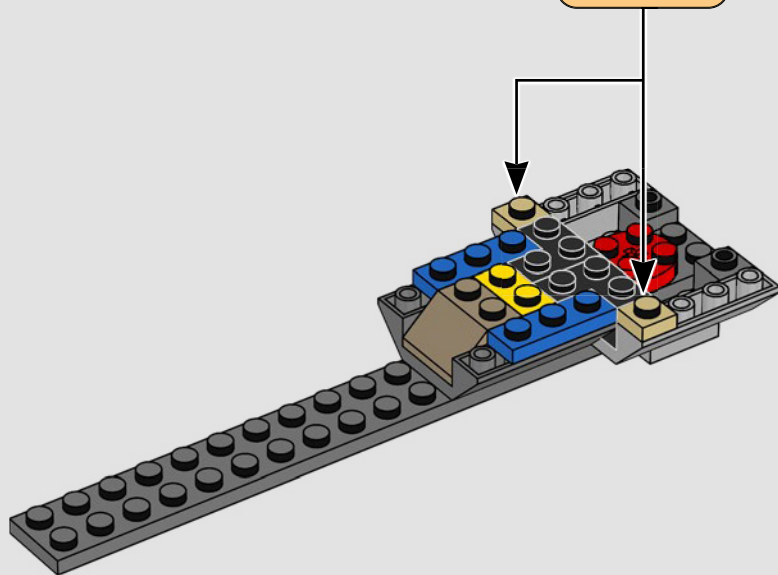



1x

11

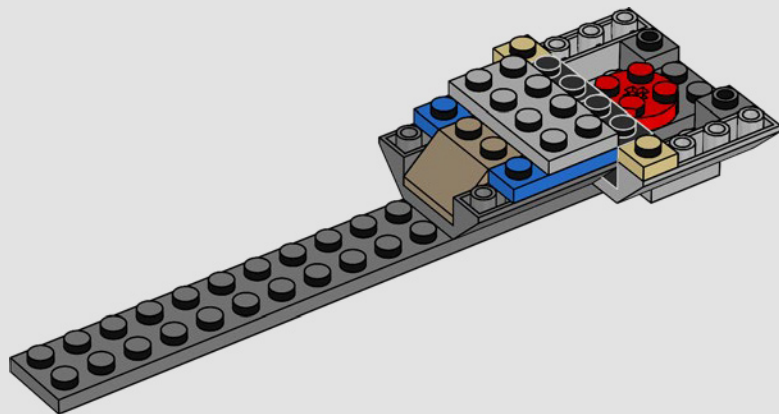

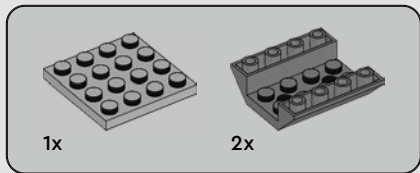

12

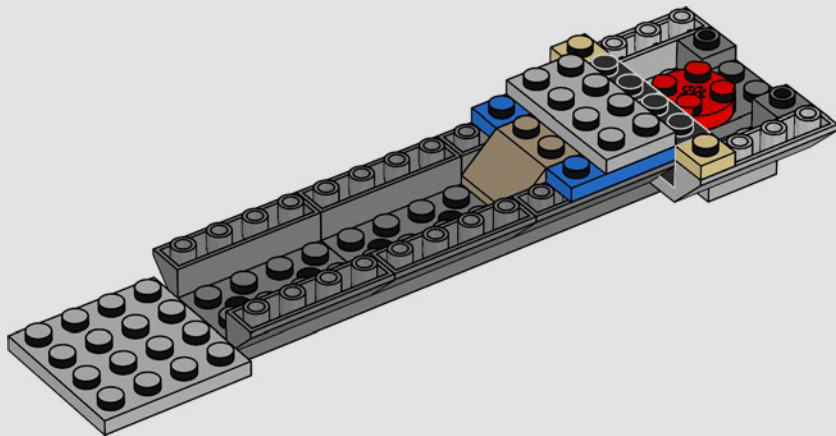

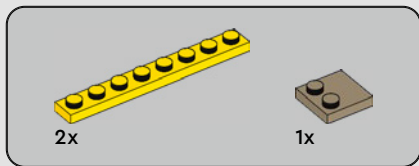

13

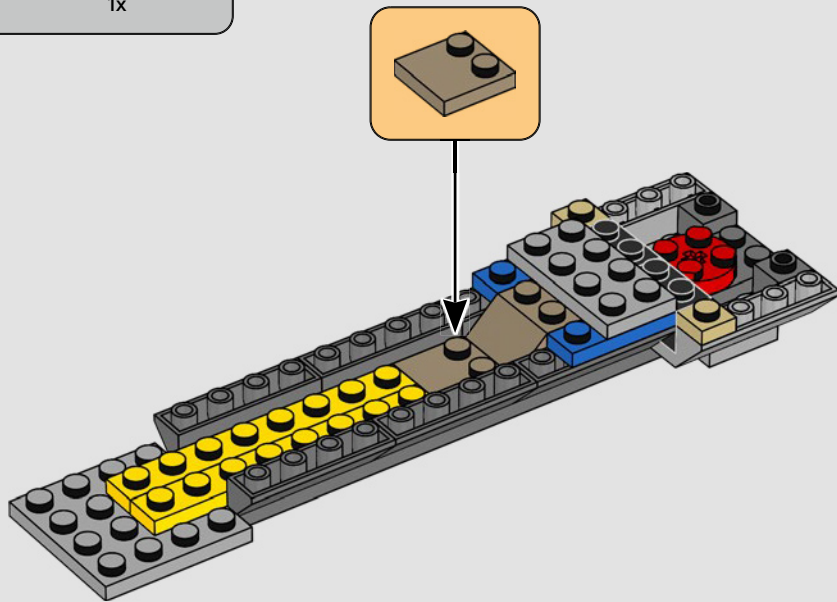



2x



2x

14

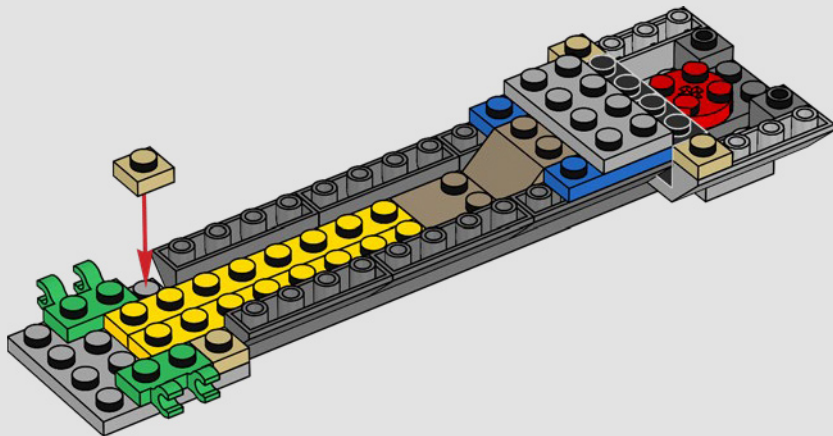



2x

15

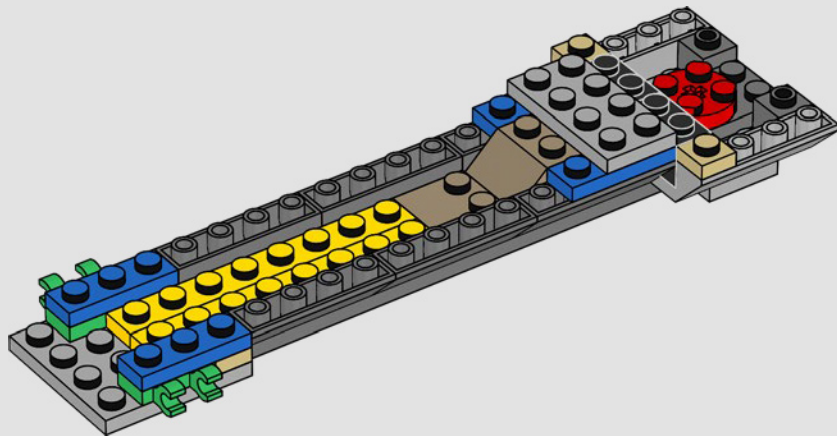



2x

16

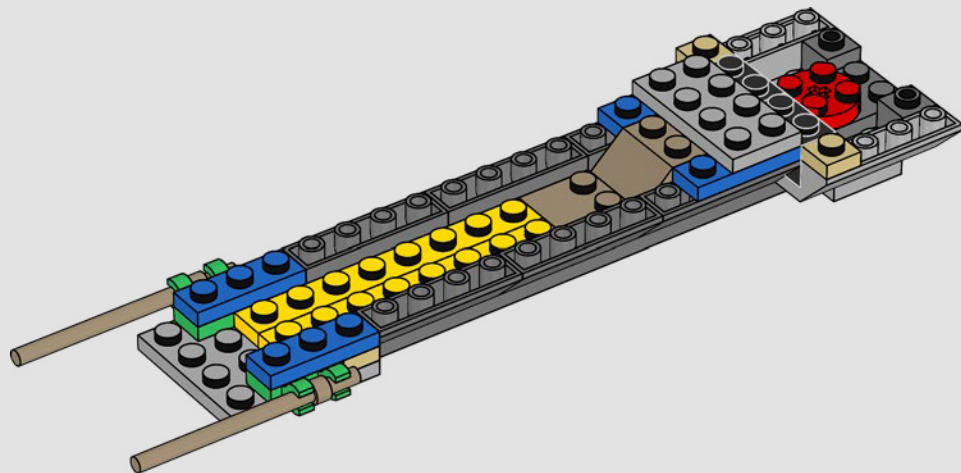



1x



1x

17

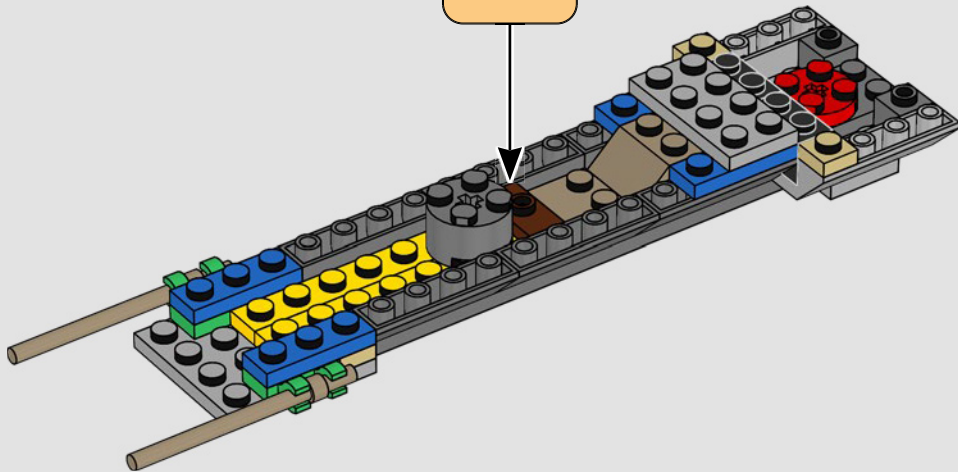

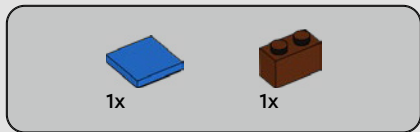

18

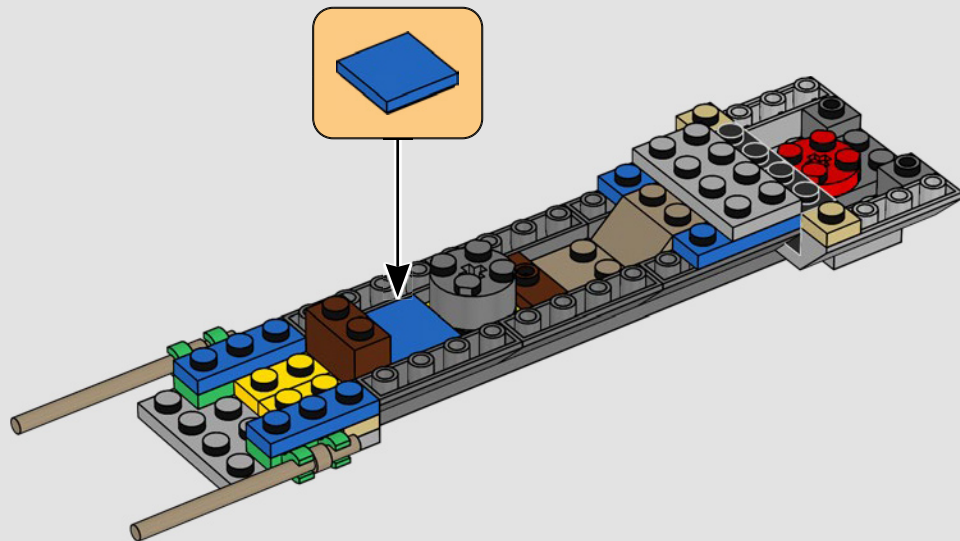



1x



1x

19

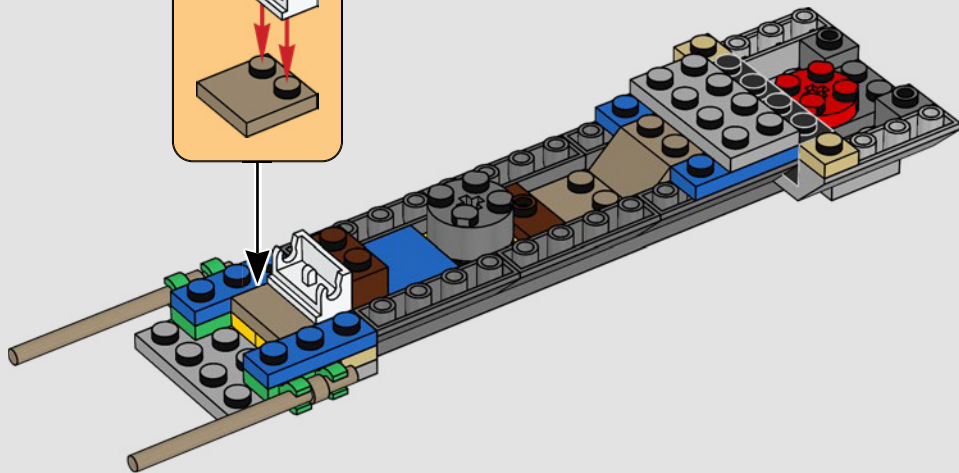
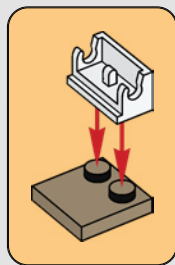



1x



1x

20

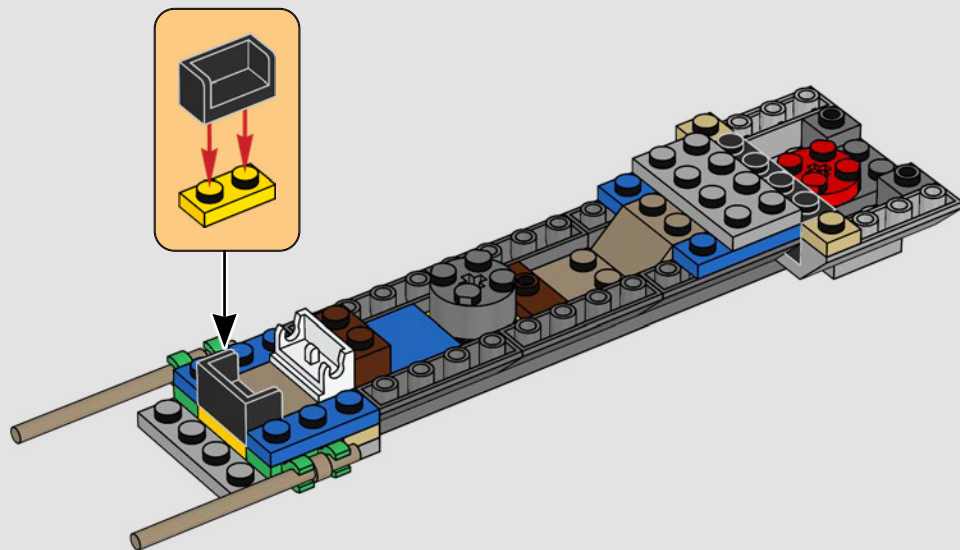

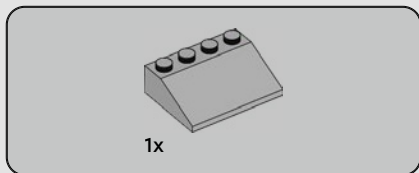

21

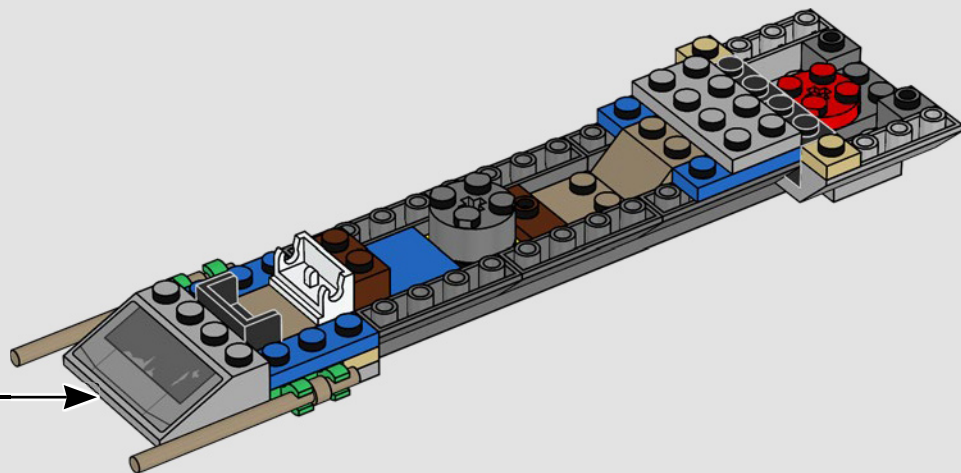
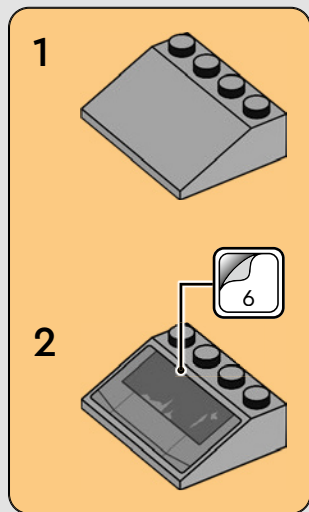

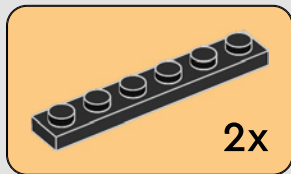
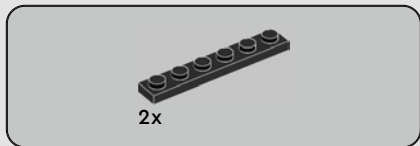

22

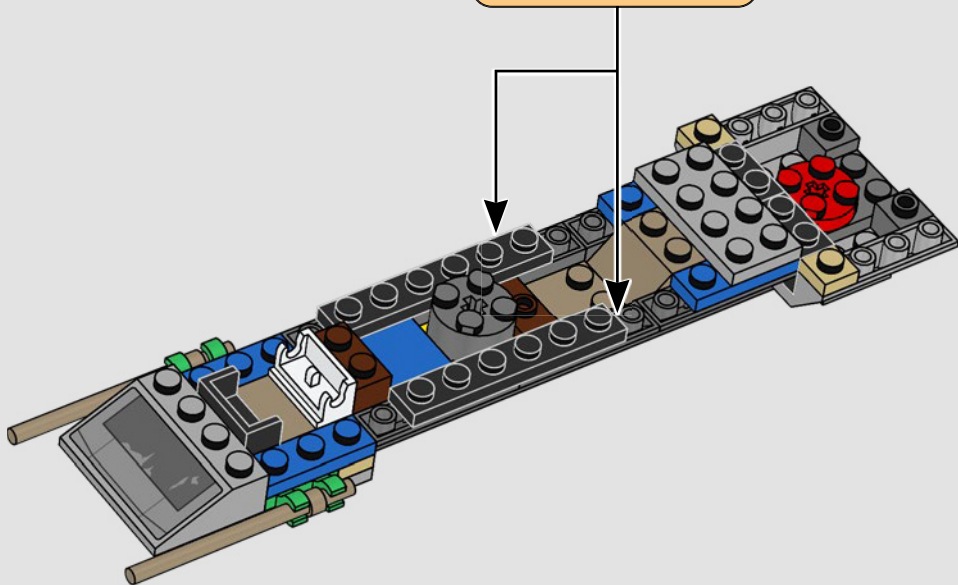

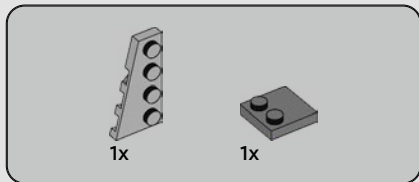
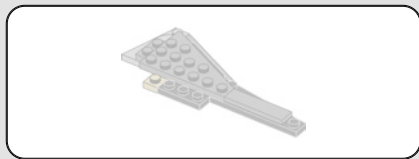

23

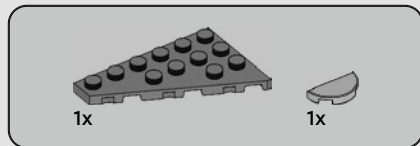
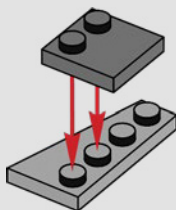

24

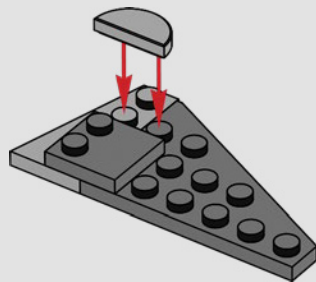

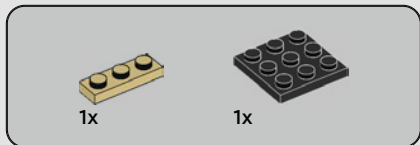

25

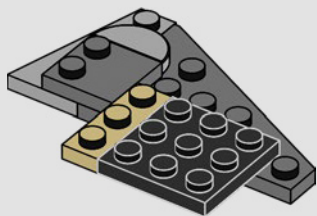

26

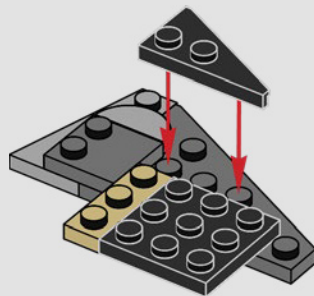

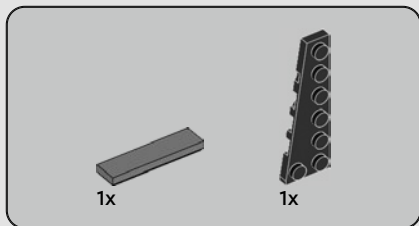

27

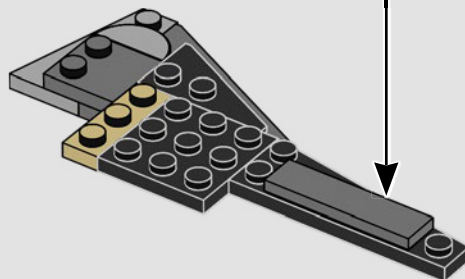
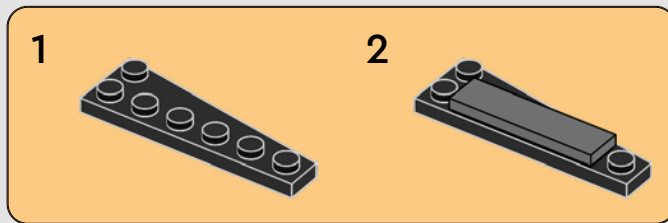

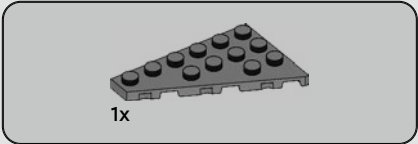

28

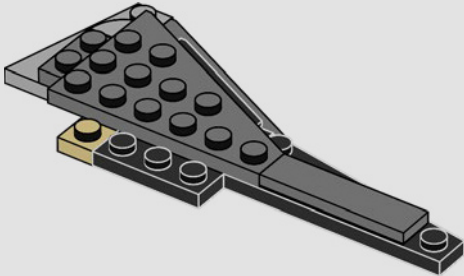

29

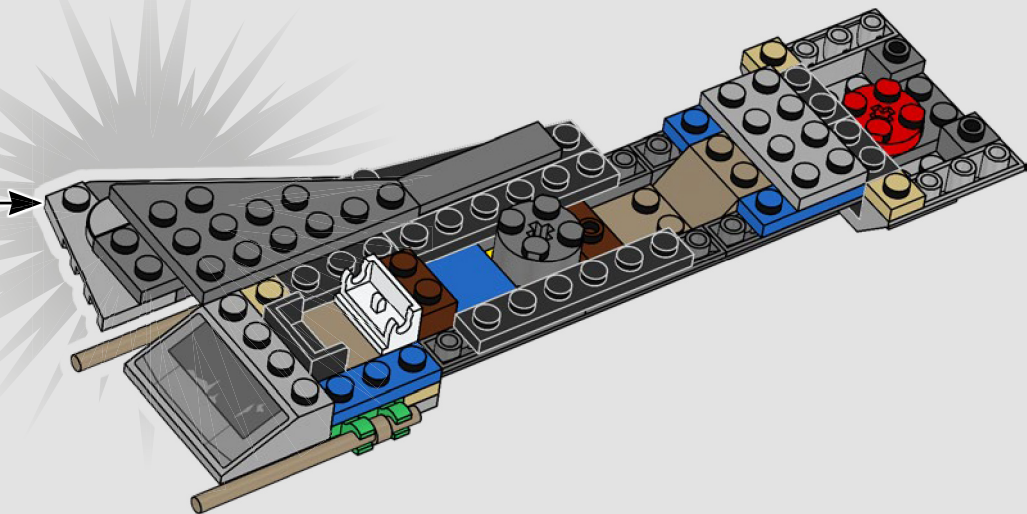

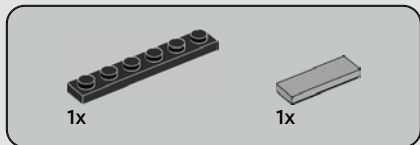

30

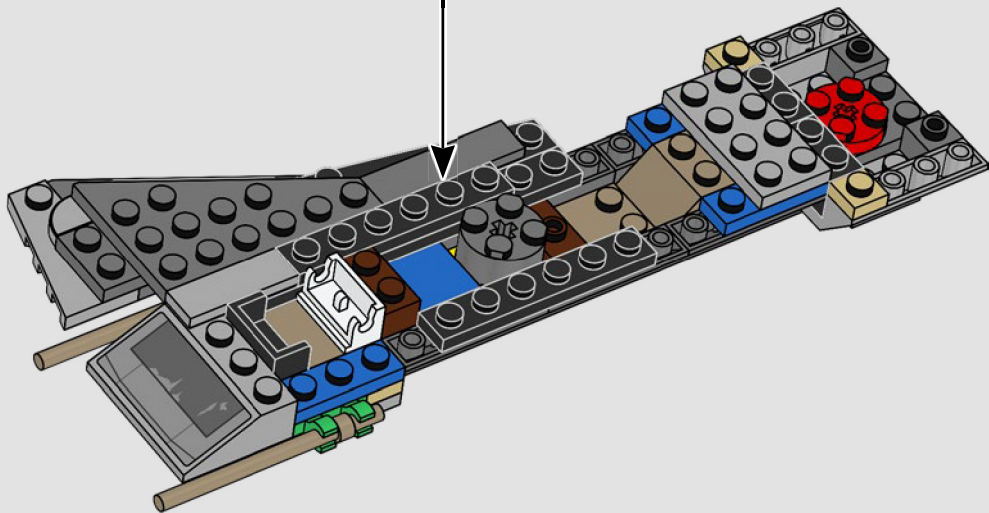
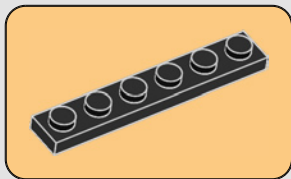

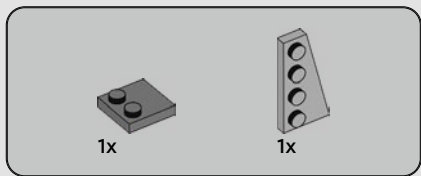
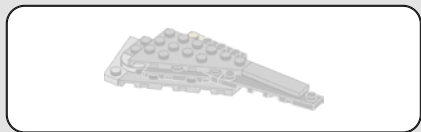

31

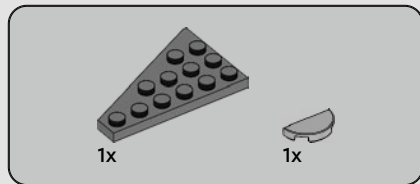
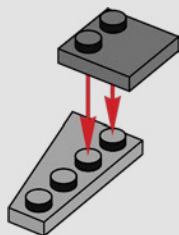

32

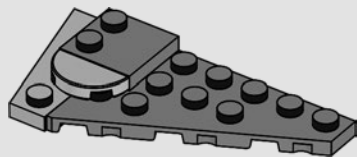

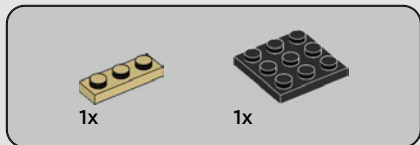

33

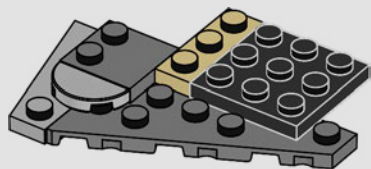

34

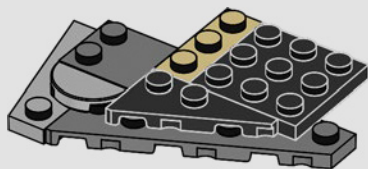

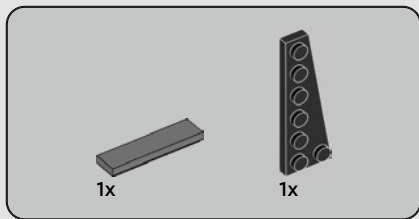

35

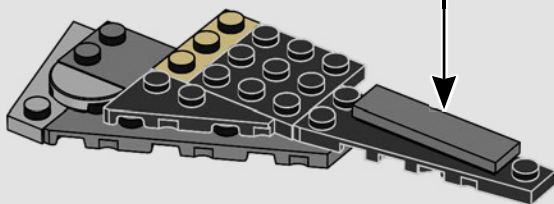
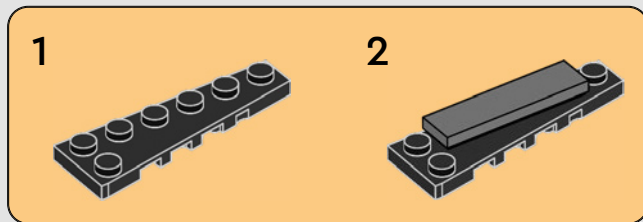

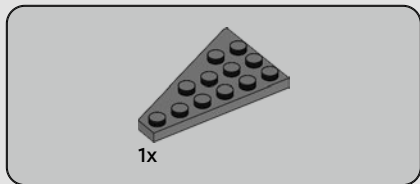

36

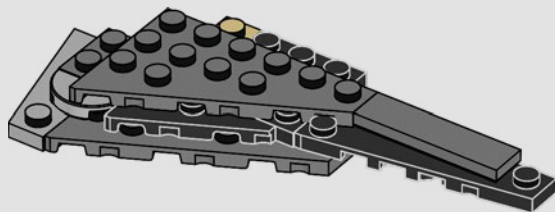

37

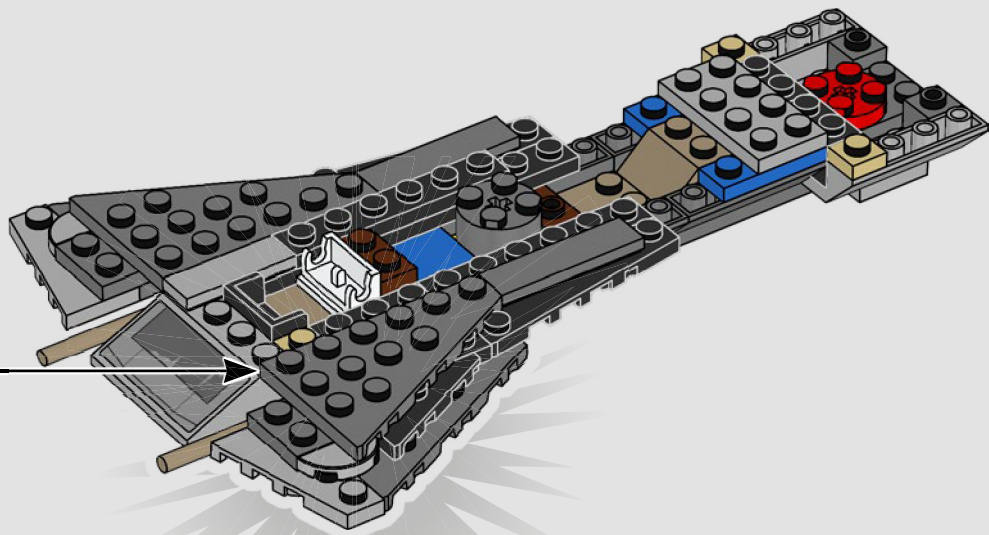

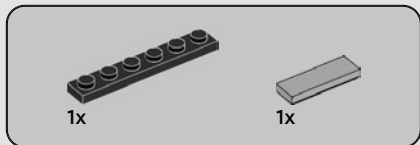

38

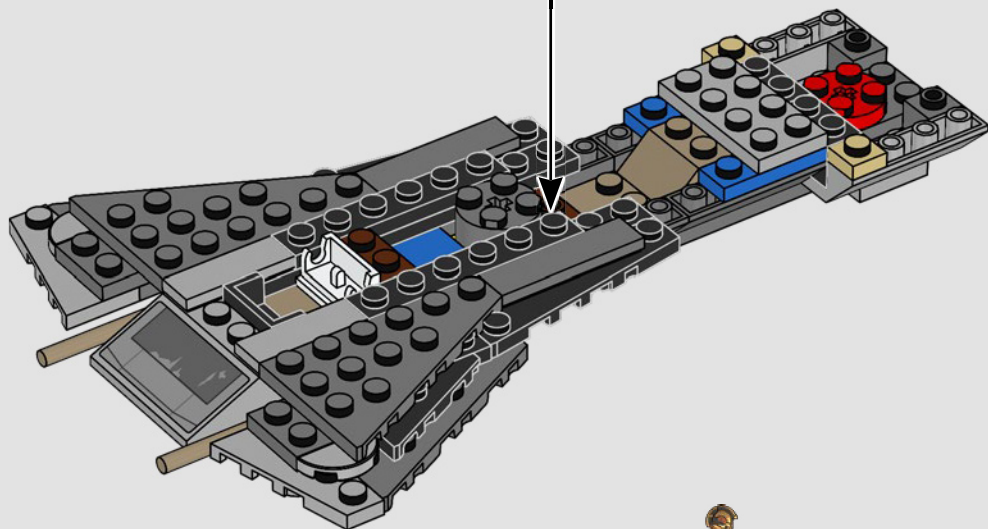
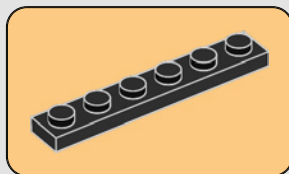



2x

39

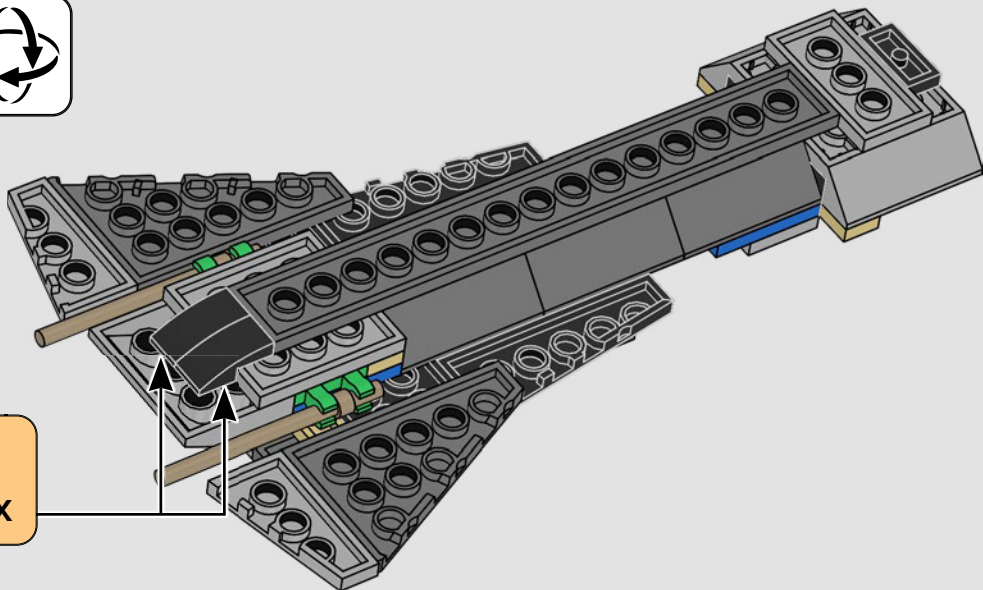
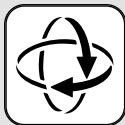

2x

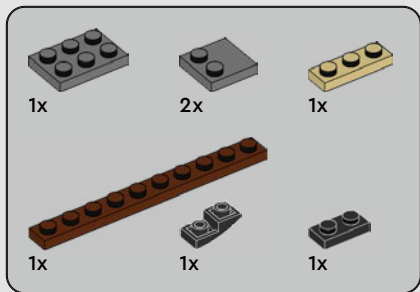

40

1

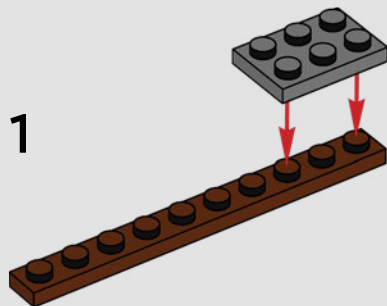

2

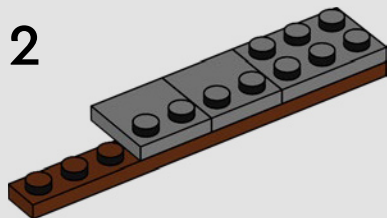

3

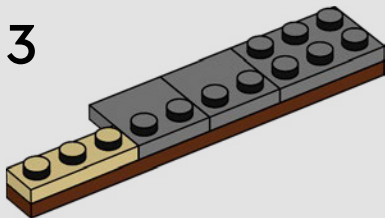

4

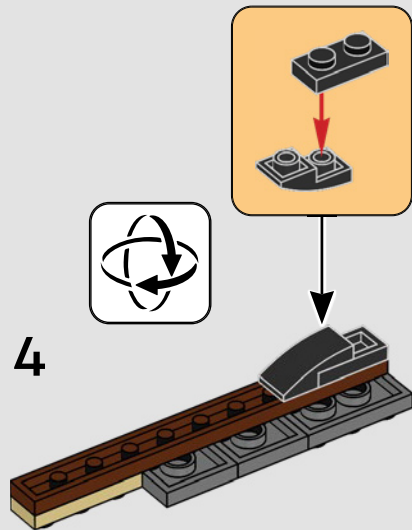

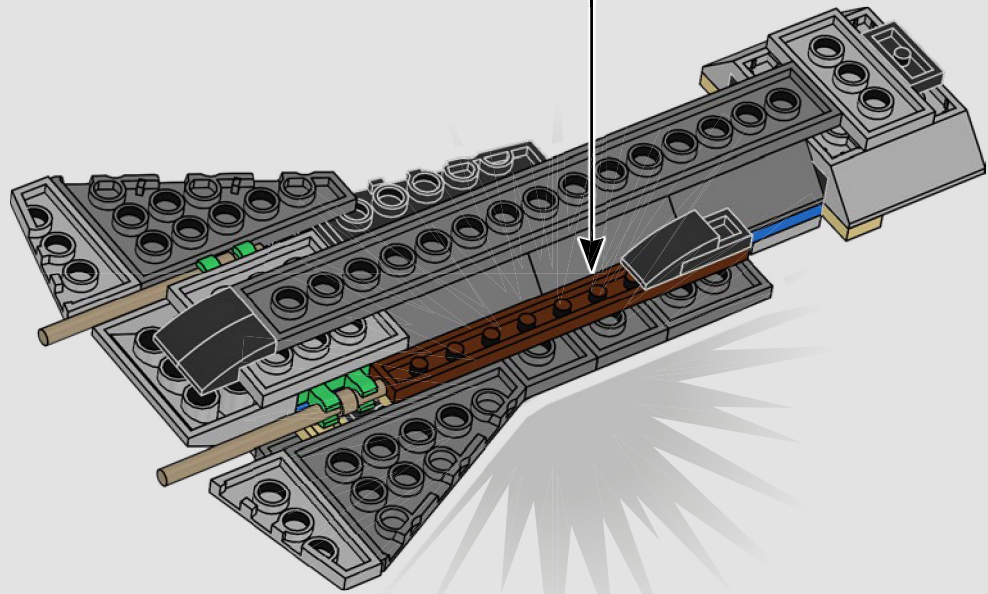

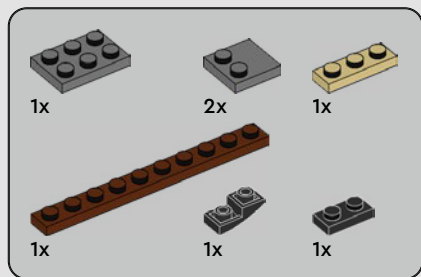
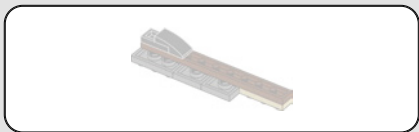

41

1

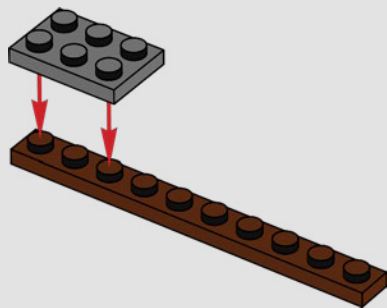

2

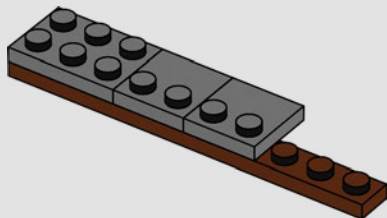

3

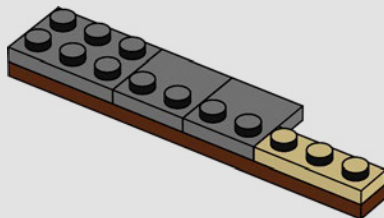

4

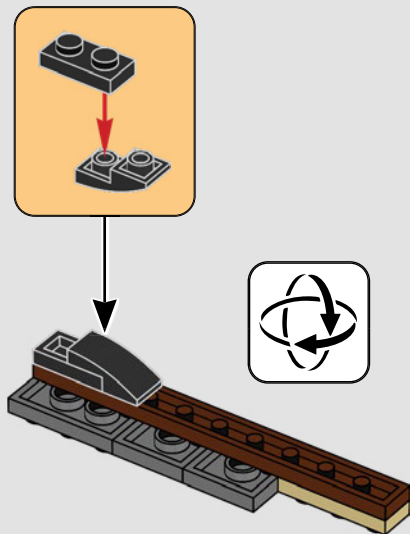

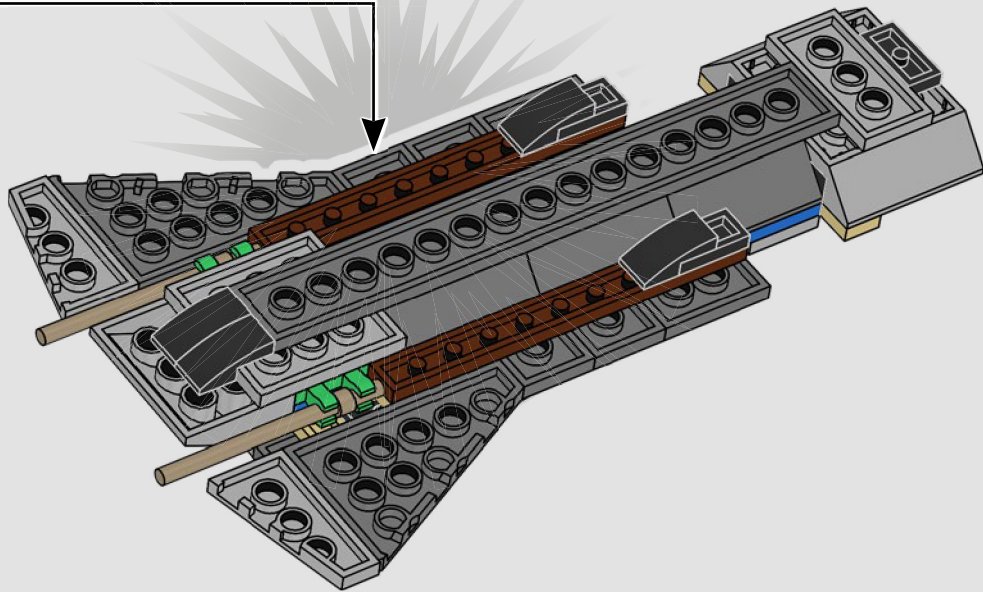

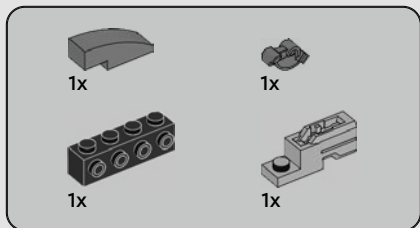

42

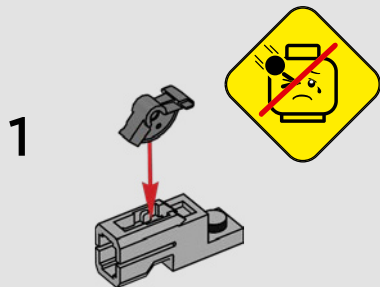

2

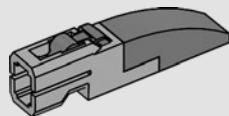

3

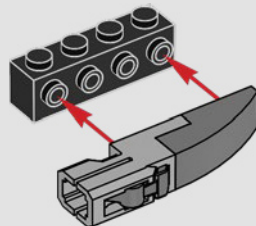

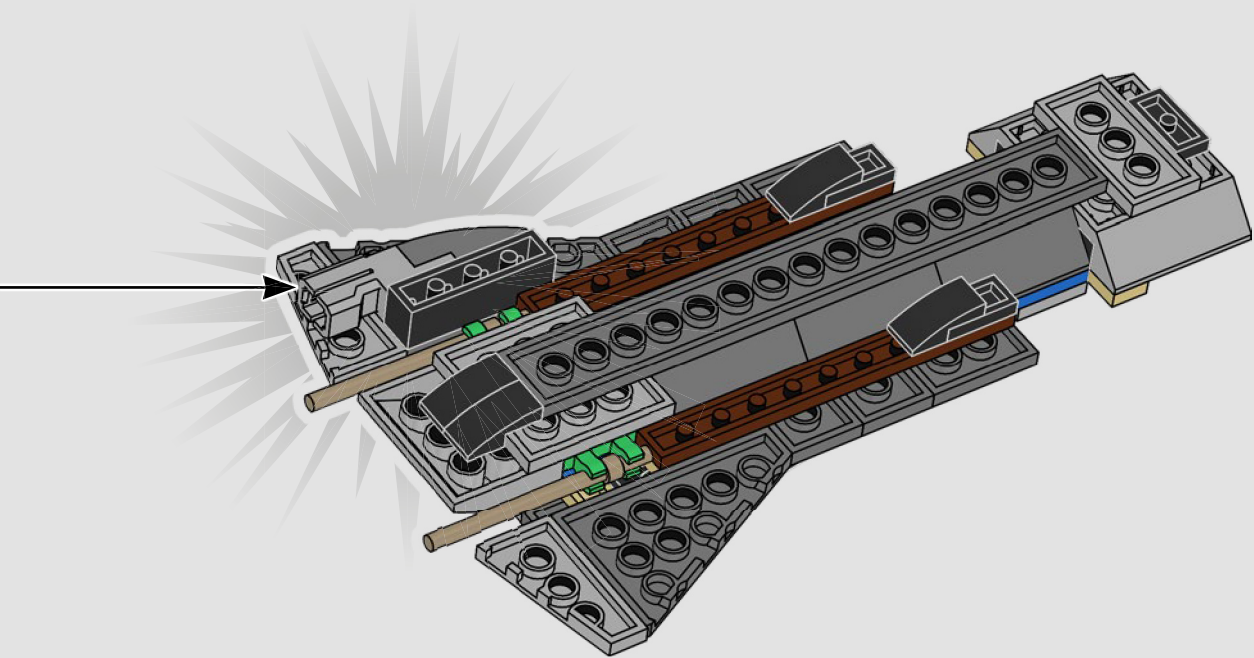

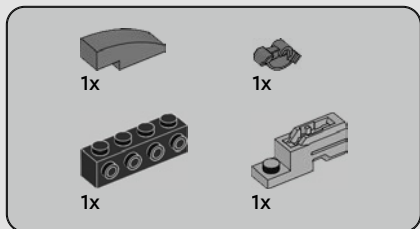

43

1

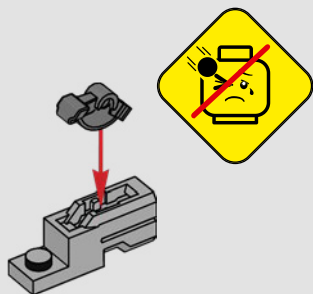

2

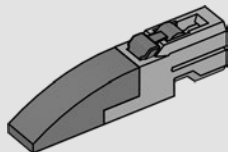

3

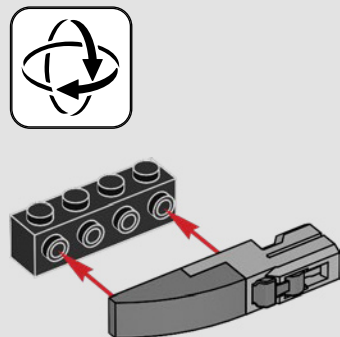

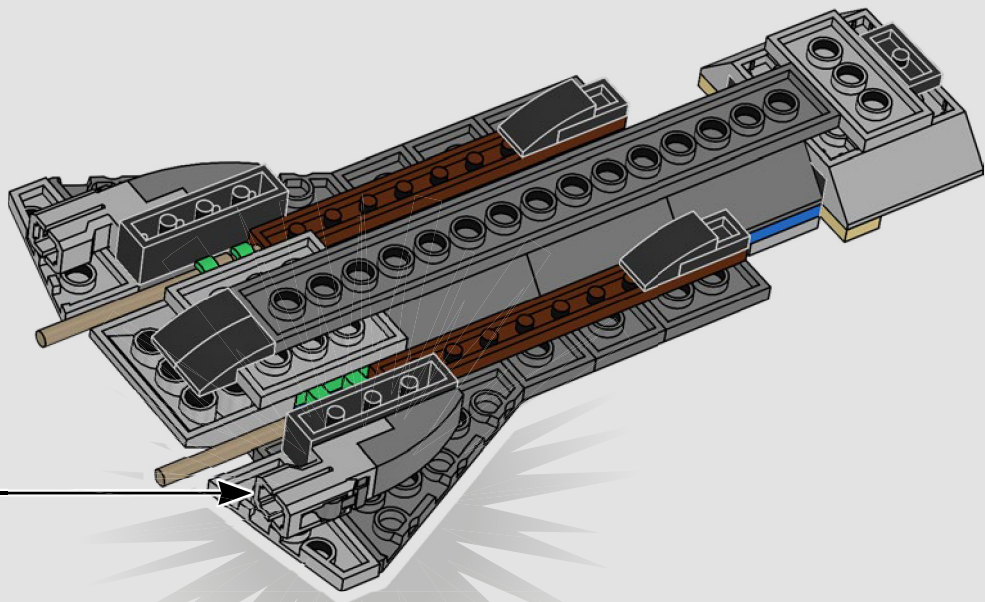



2x

44

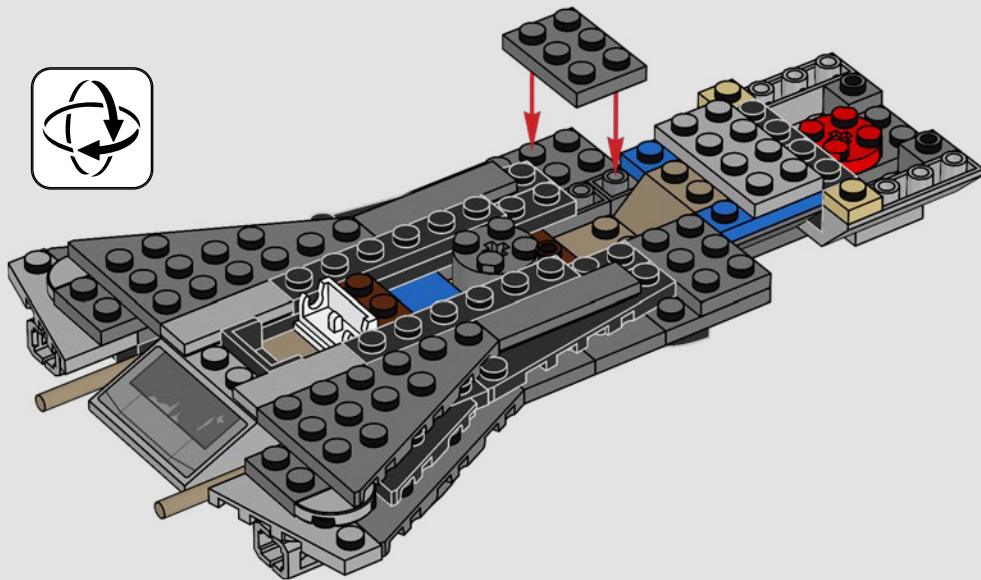



1x

45

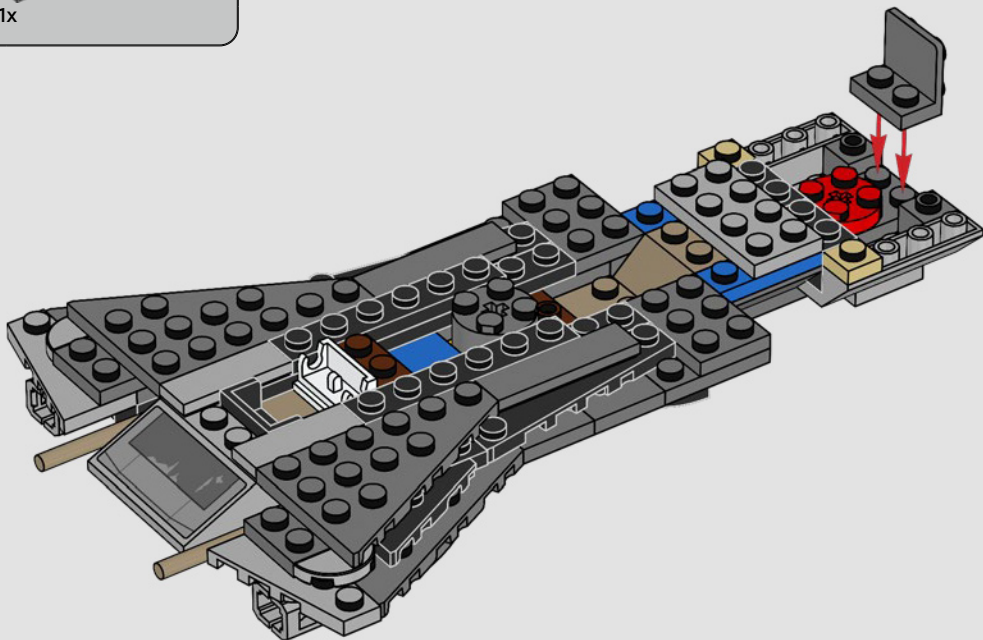

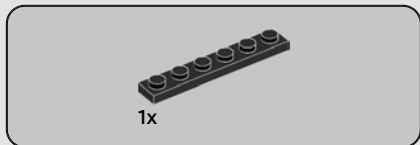

46

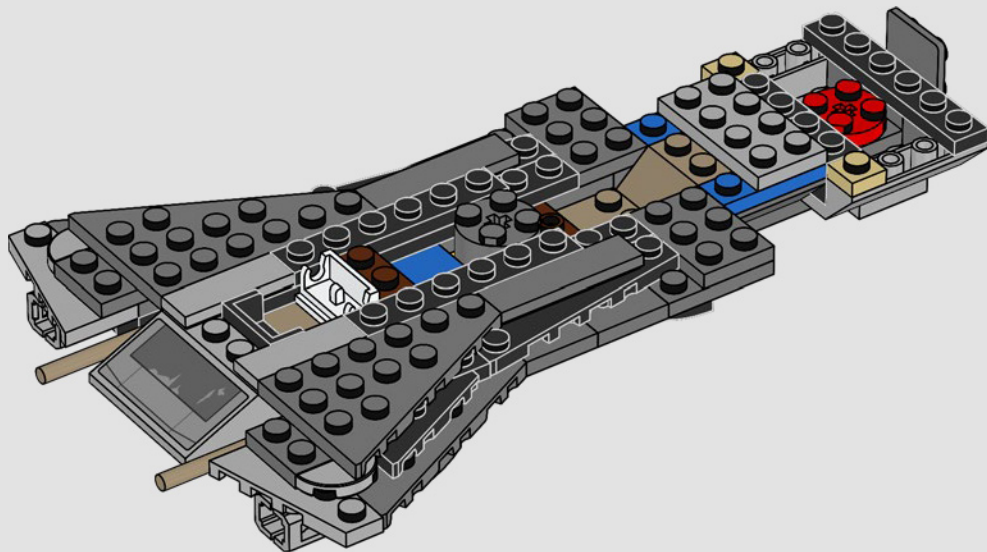

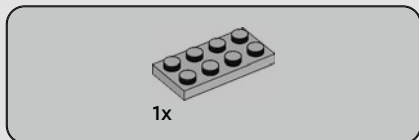
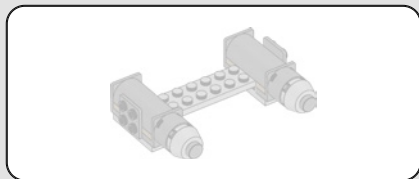

47

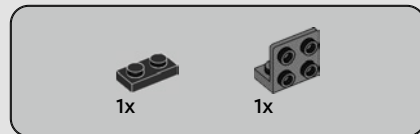
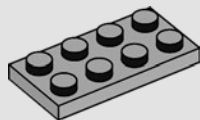

48

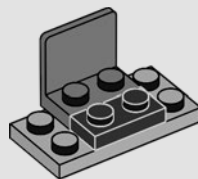

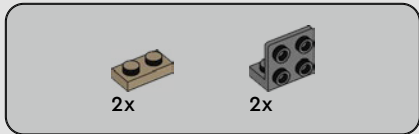

49

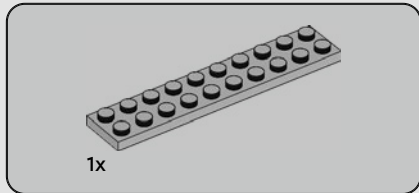
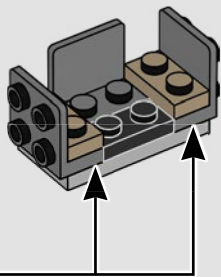
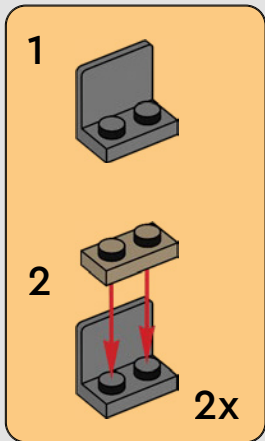

50

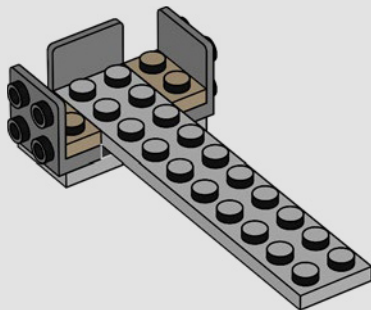

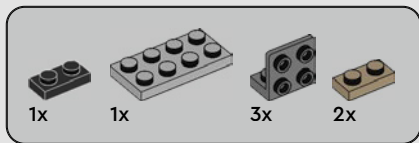

51

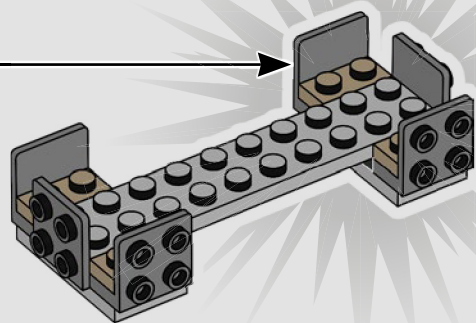
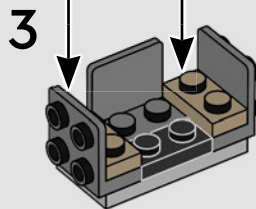
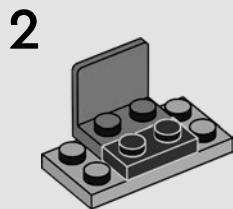
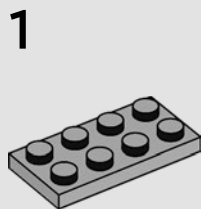
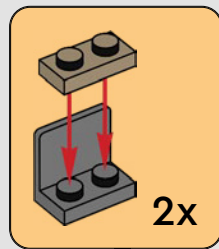

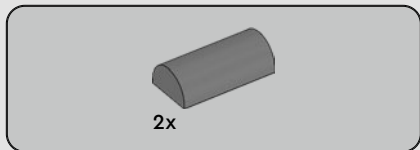

52

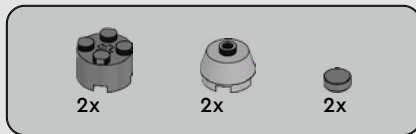
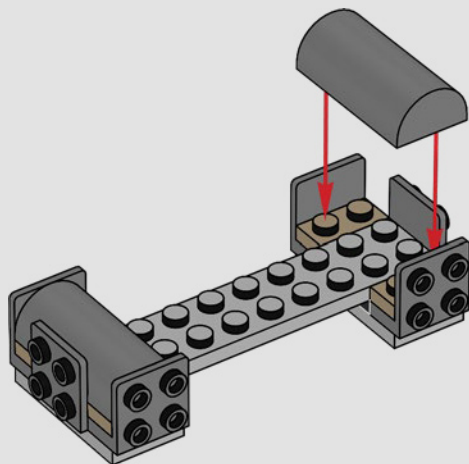

53

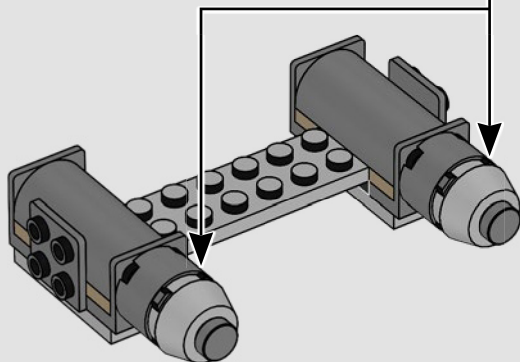
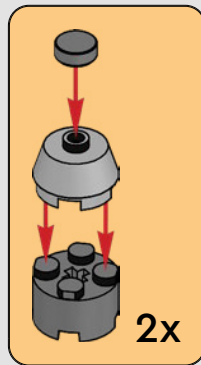

54

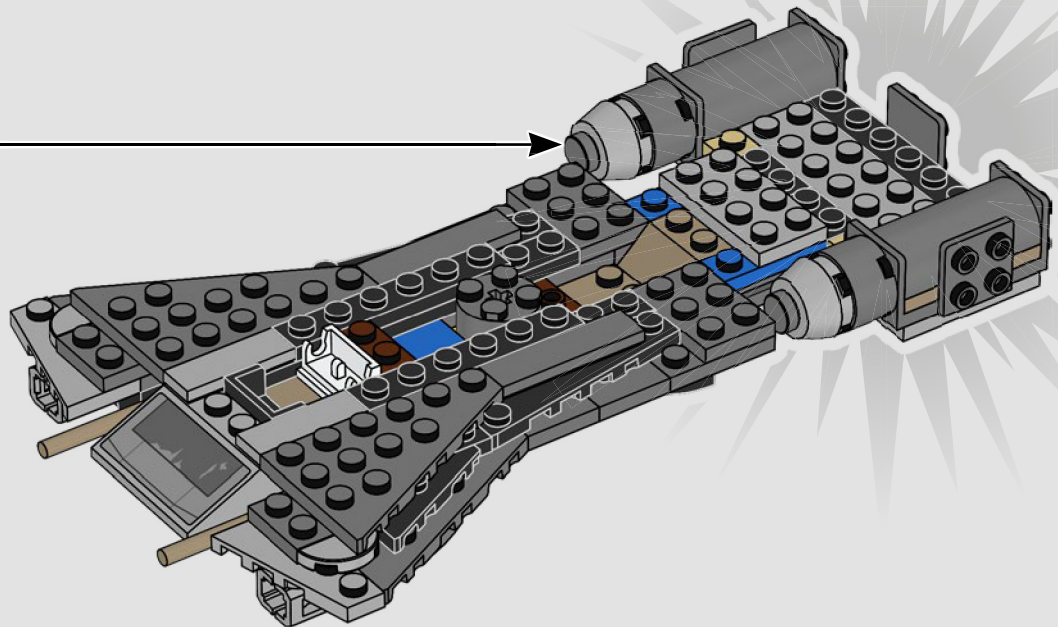



2x



1x

55

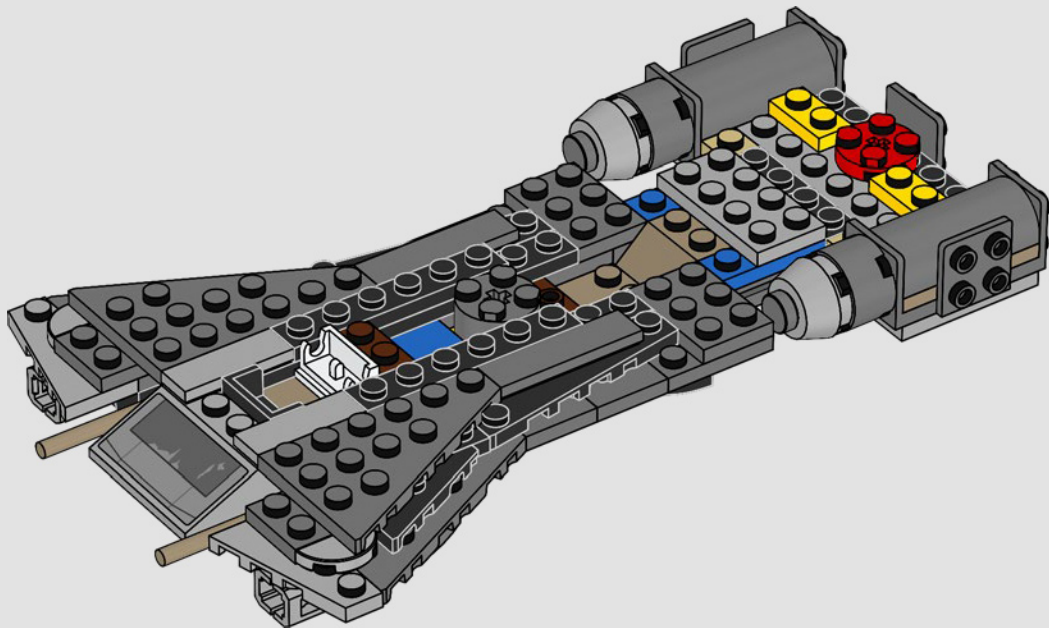



2x

56

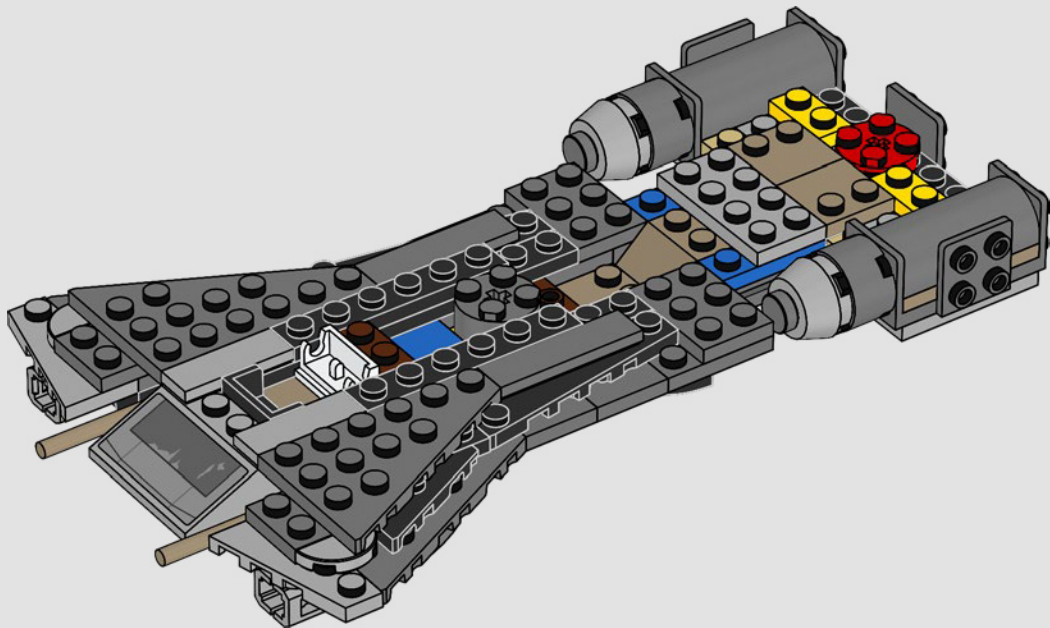

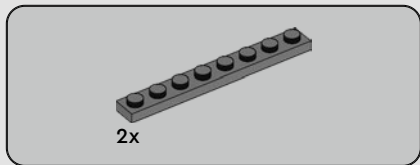

57

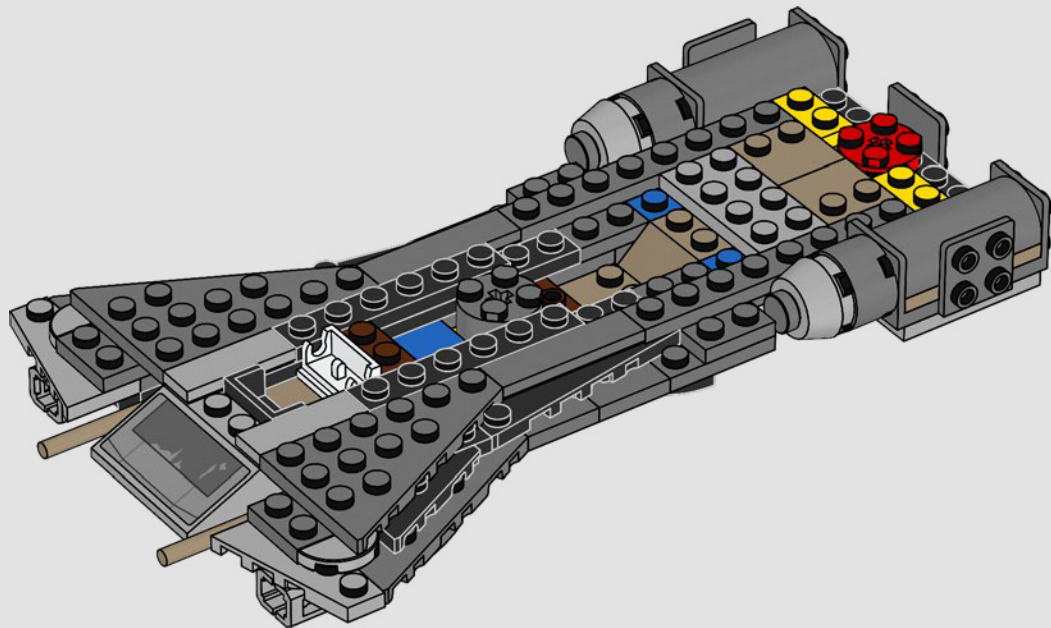

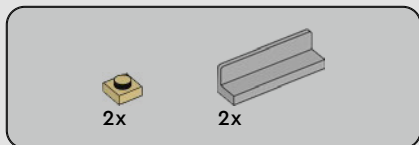

58

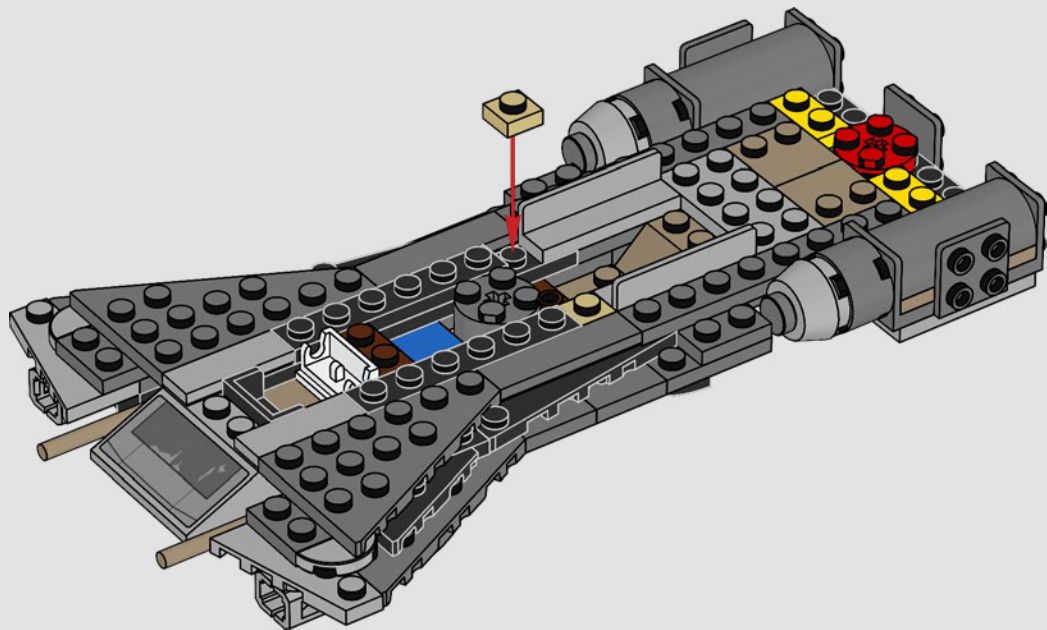



1x



1x

59

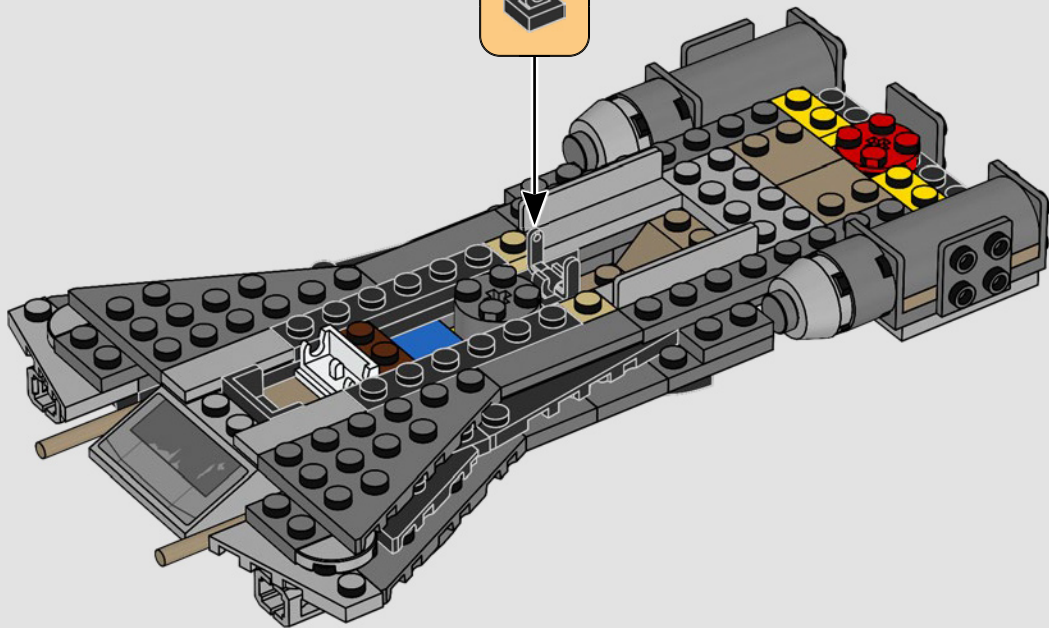
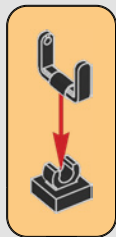



1x



1x



60

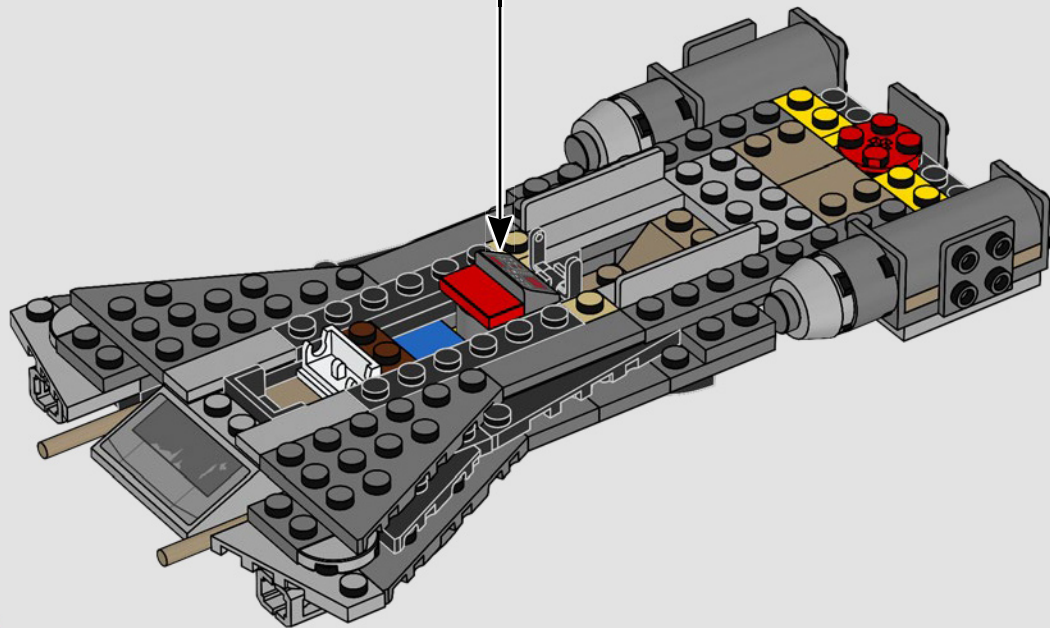



1x



1x

61

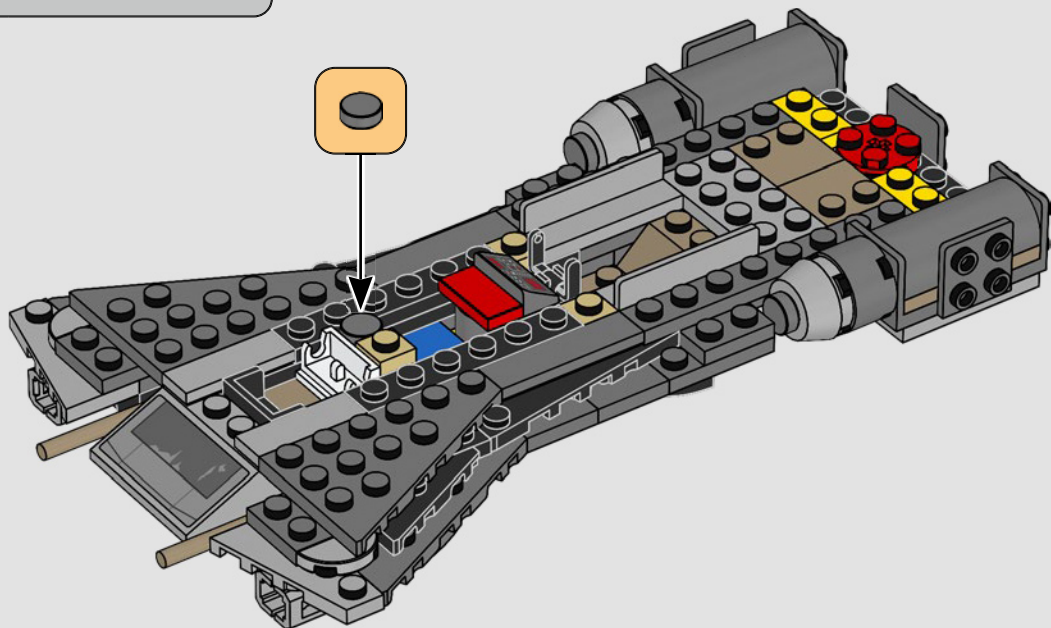

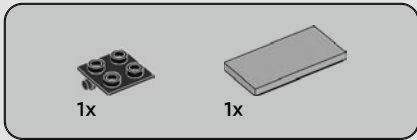

62

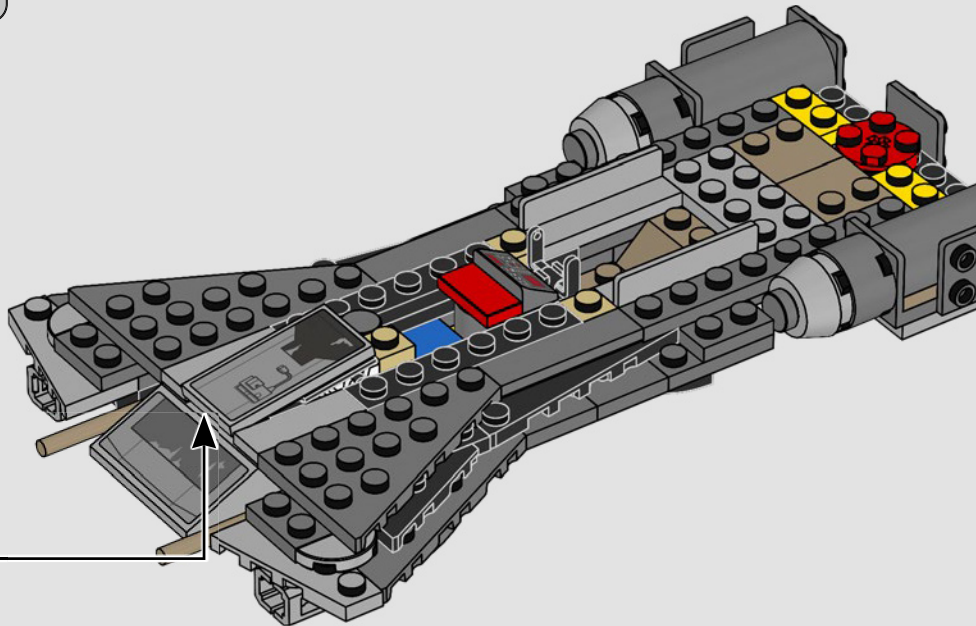
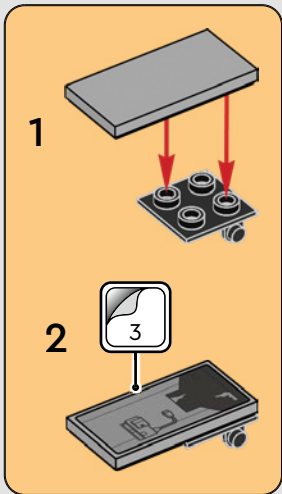



2x



2x

63

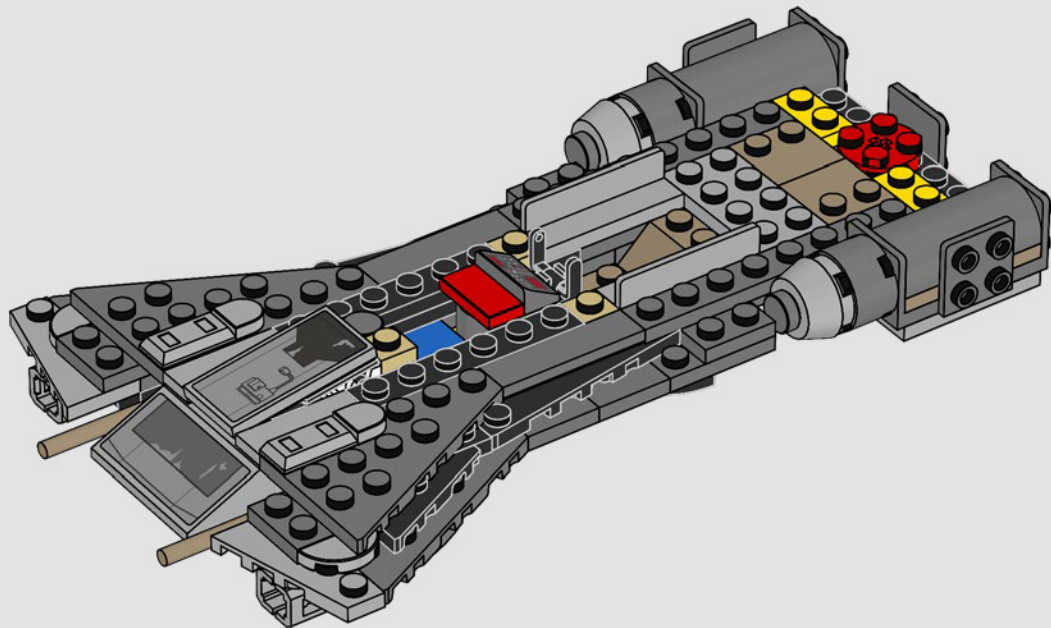



2x

64

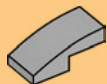

2x

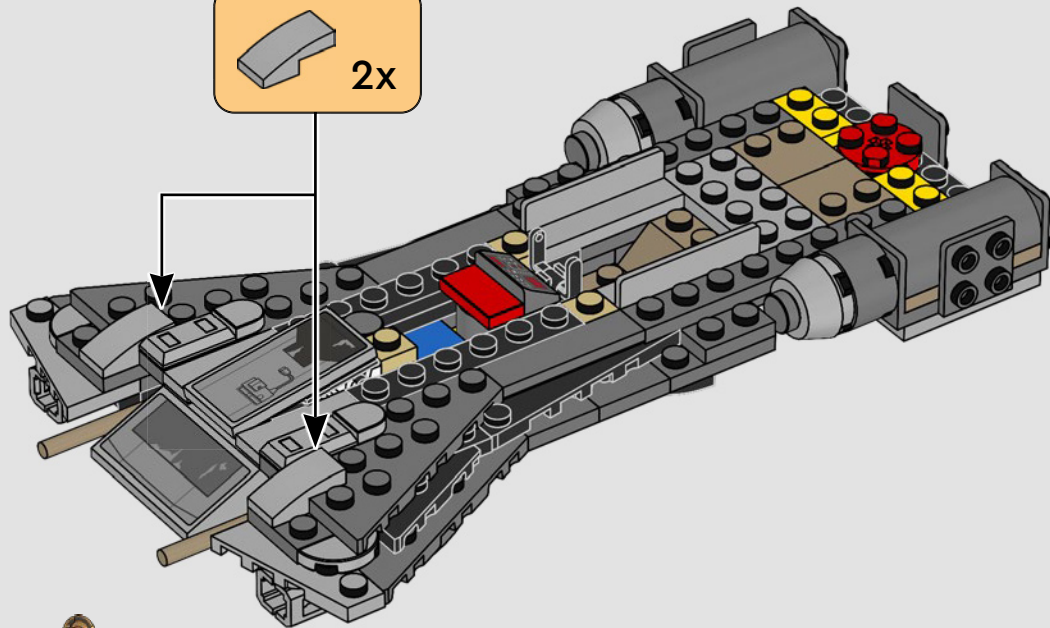

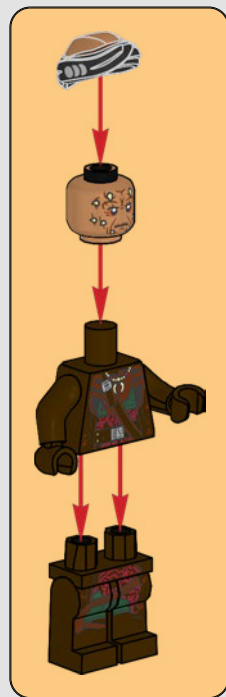



4x



2x

65



1

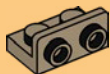

2

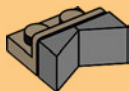

2x

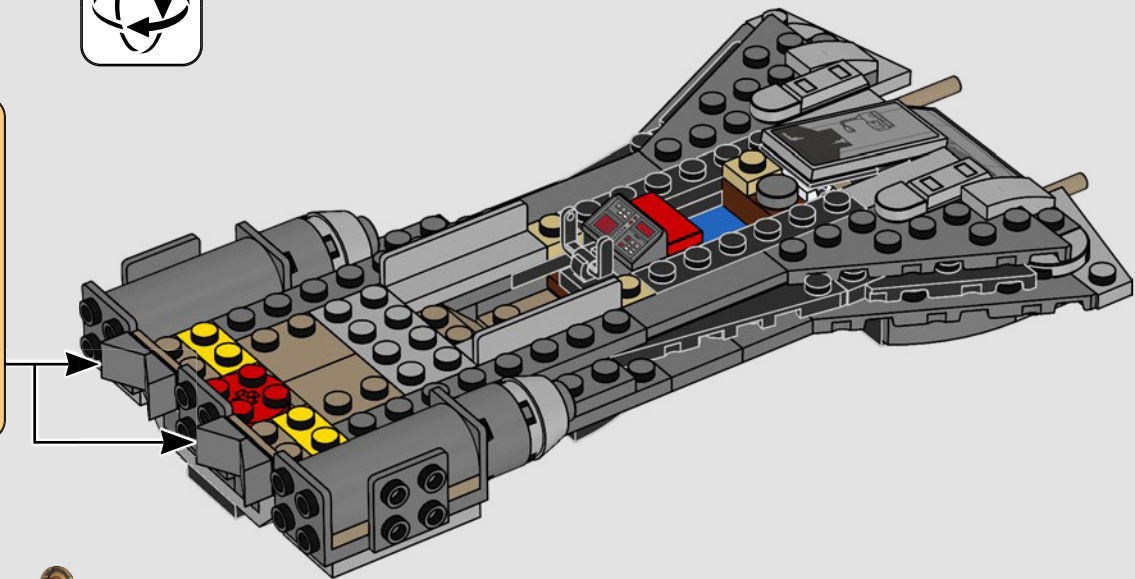



3x

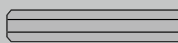

3

1:1



3x



3x



3x



3x



3

3x



3x

66

1

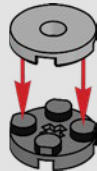

2



3

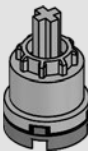

4

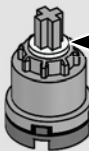

5



3x

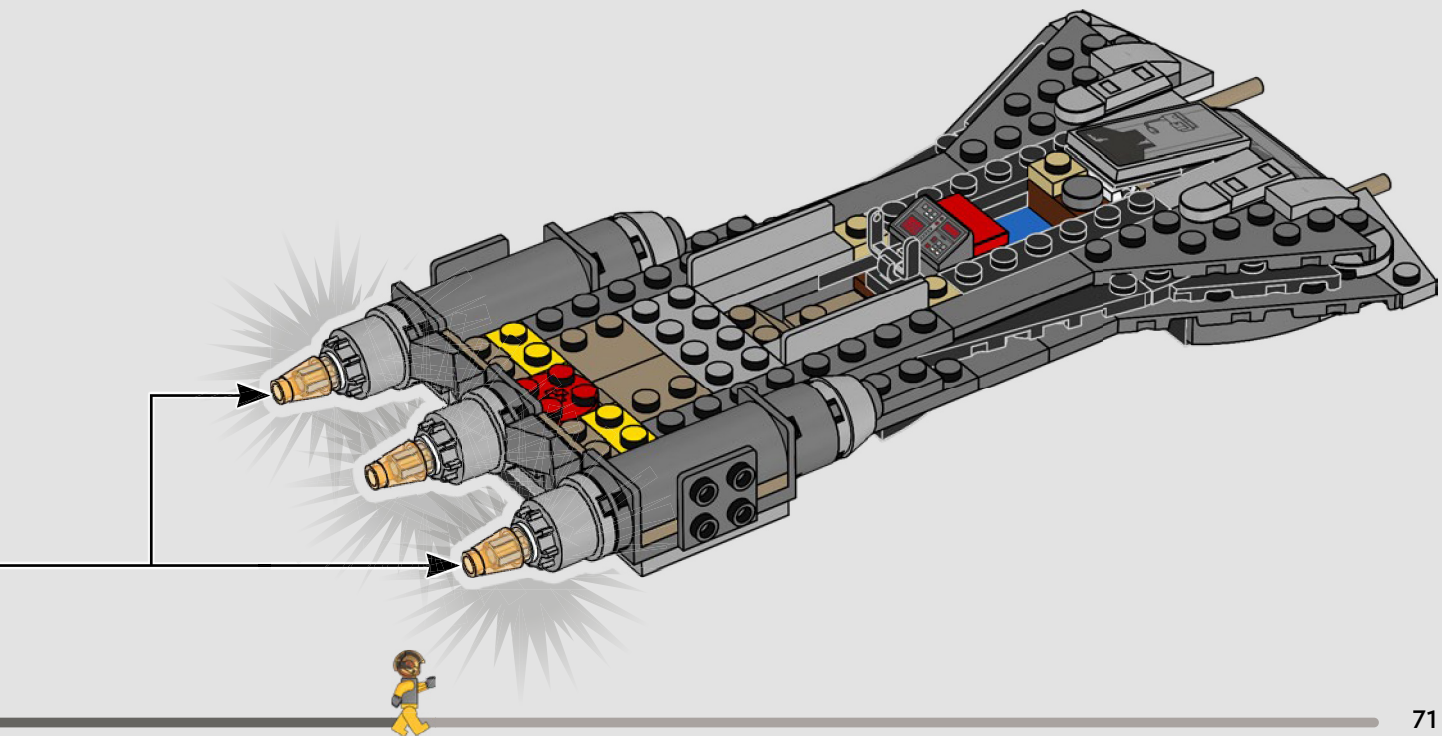

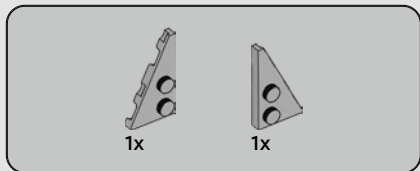

67

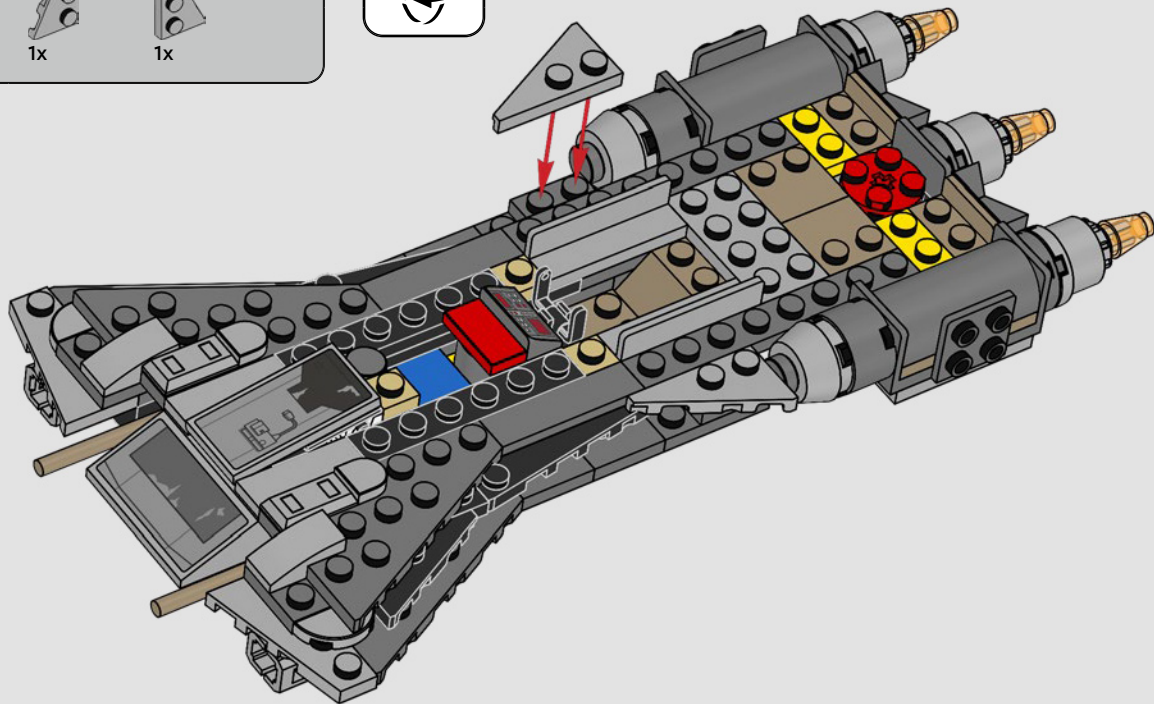

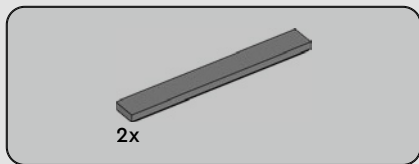

68

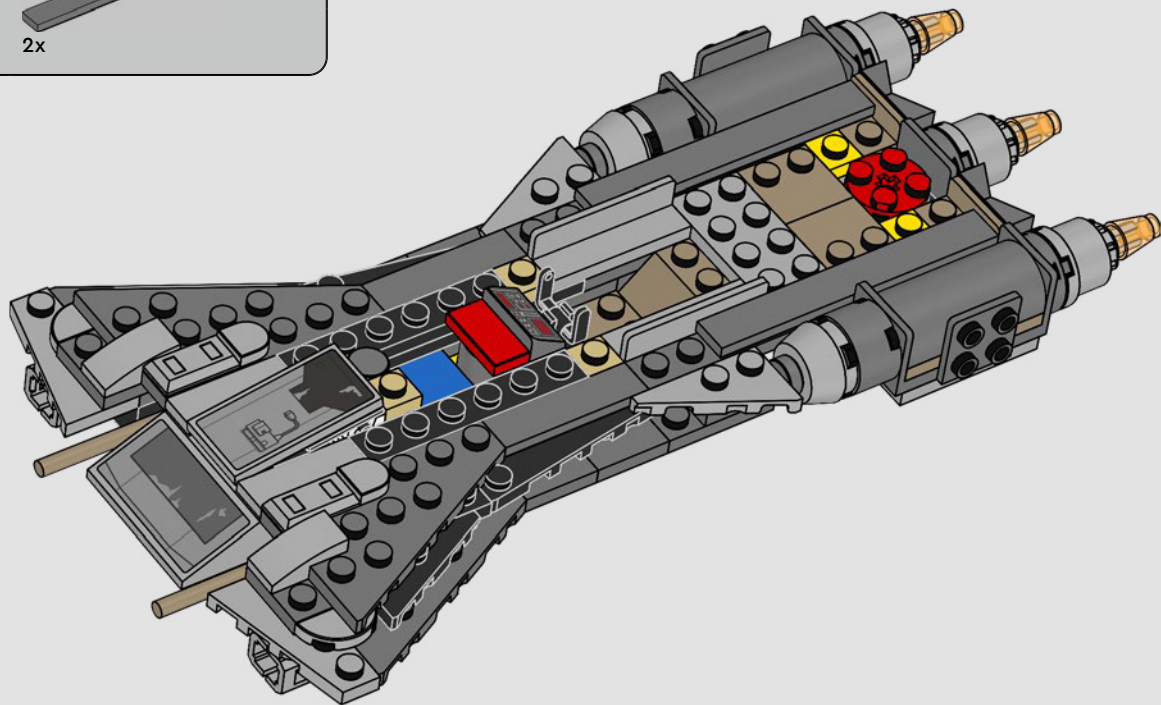



2x

69

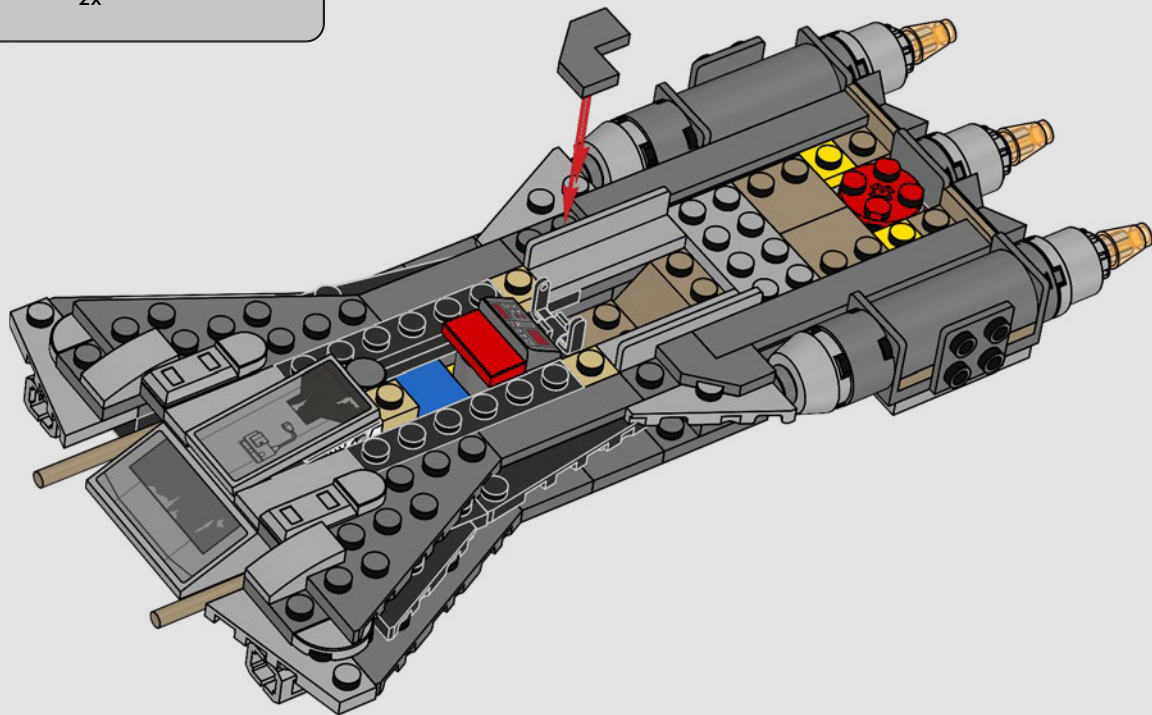



1x

70

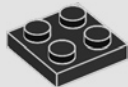

2x

71

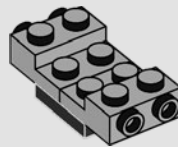



1x



1x



1x

72

1



2

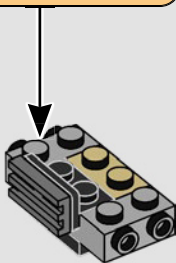

1x

73

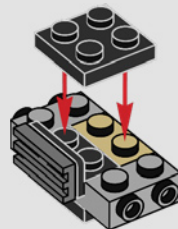

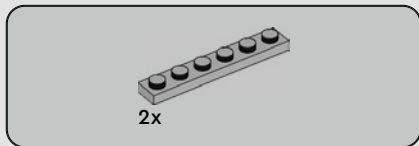

74

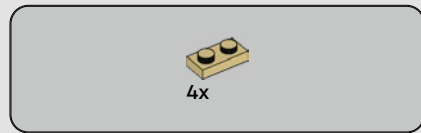
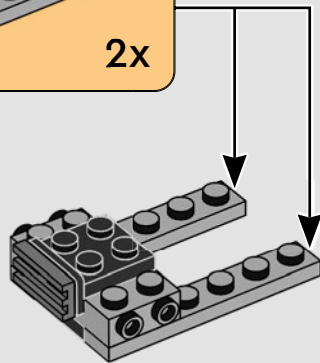
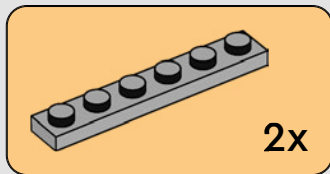

75

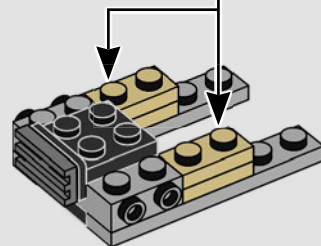
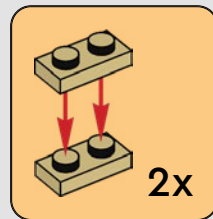

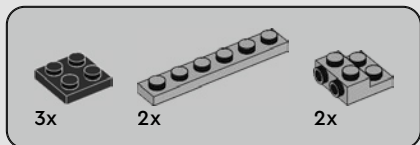

76

1

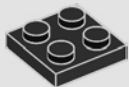

2

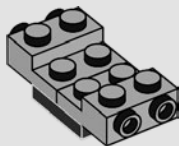

3

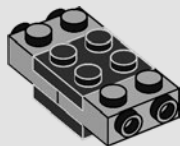

4

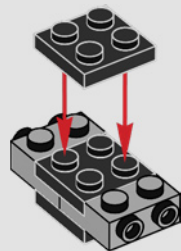

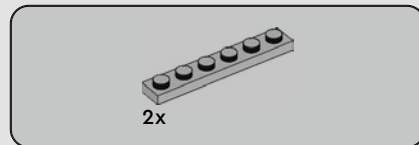
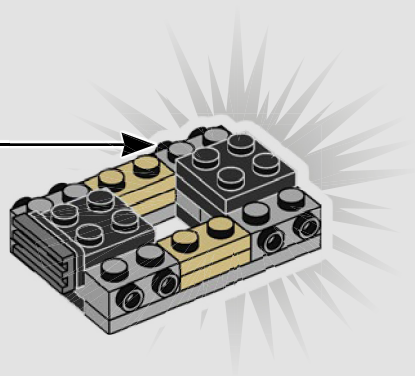

77

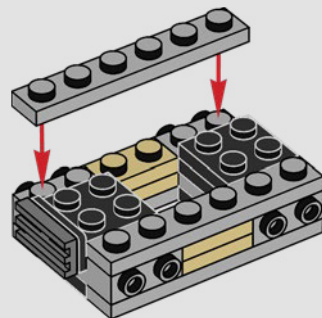

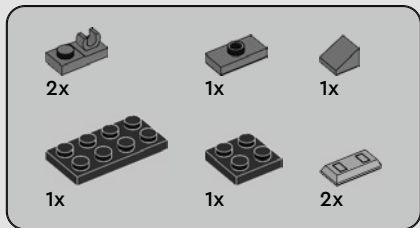

78

1

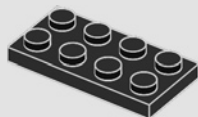

2

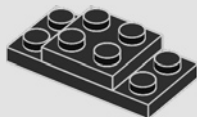

3

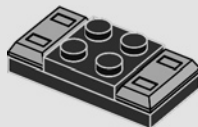

4

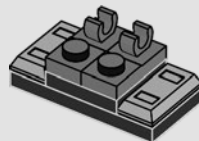

5

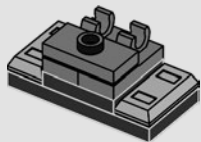

6

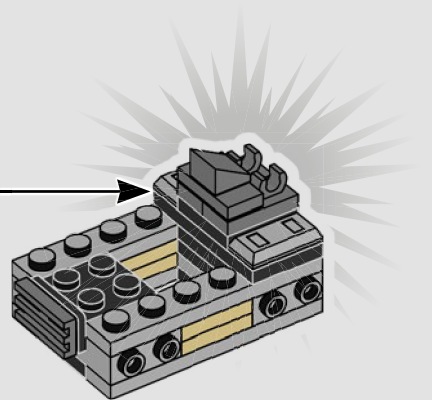
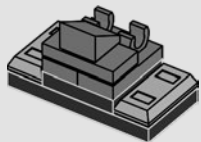

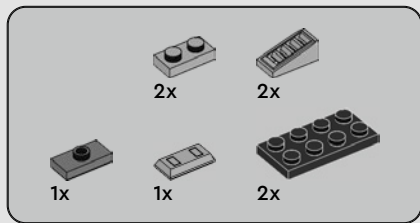

79

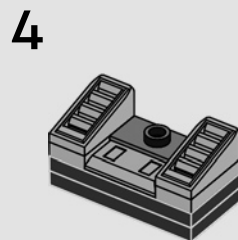
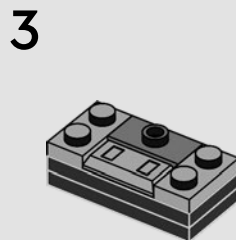
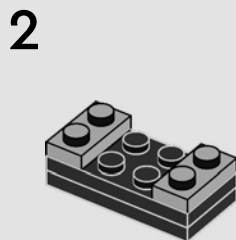
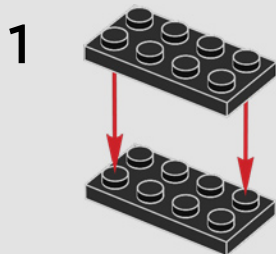

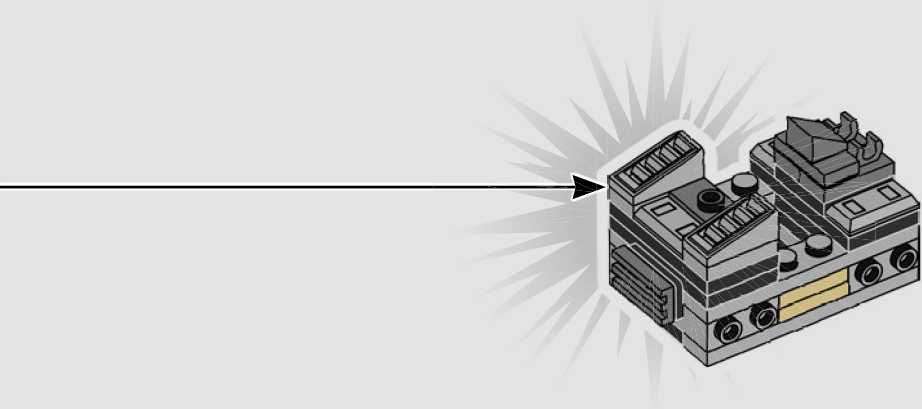

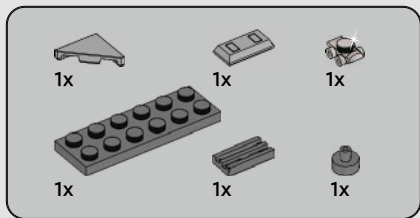

80

1

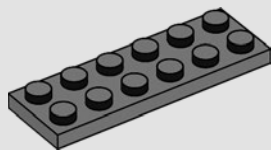

2

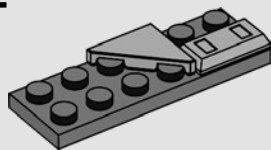

3

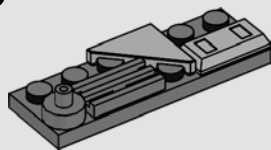

4

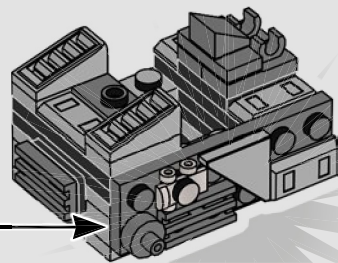
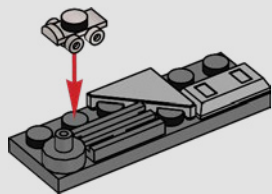

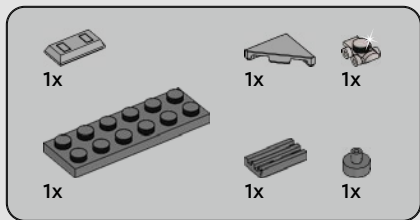

81

1

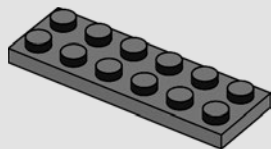

2

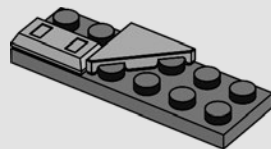

3

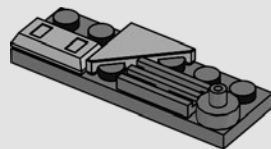

4

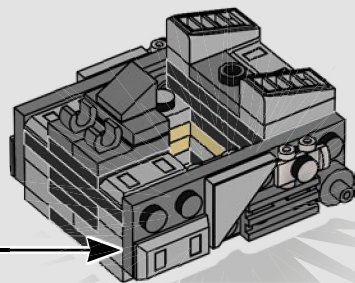
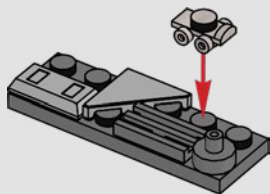

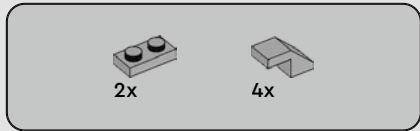

82

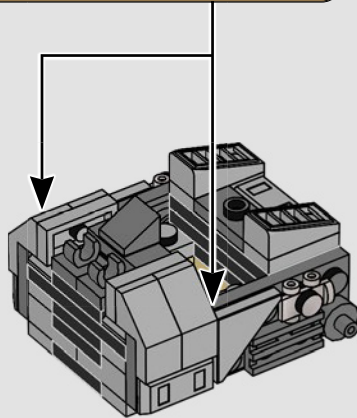
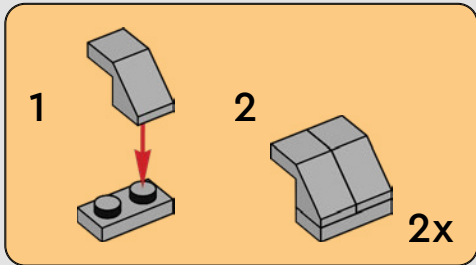

83

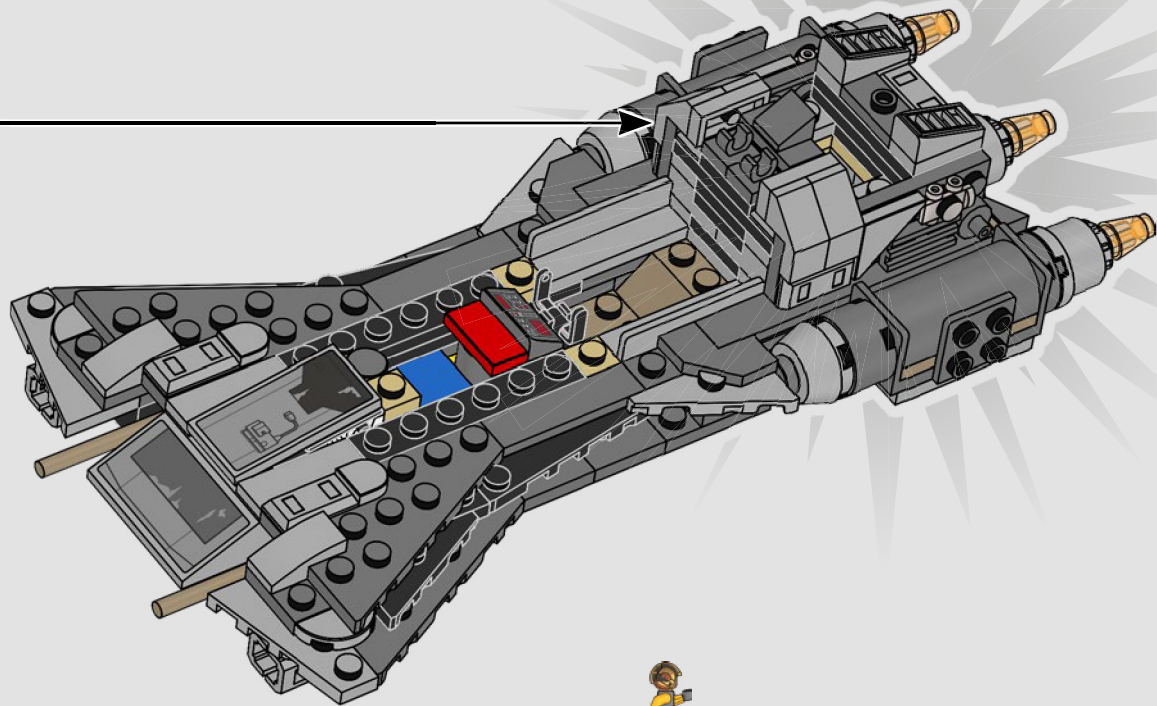

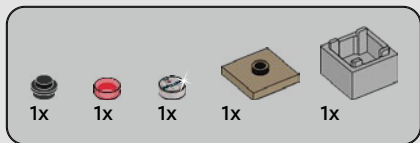

84

1

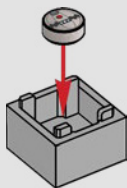

2

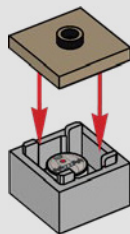

3

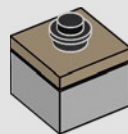

4

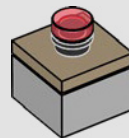

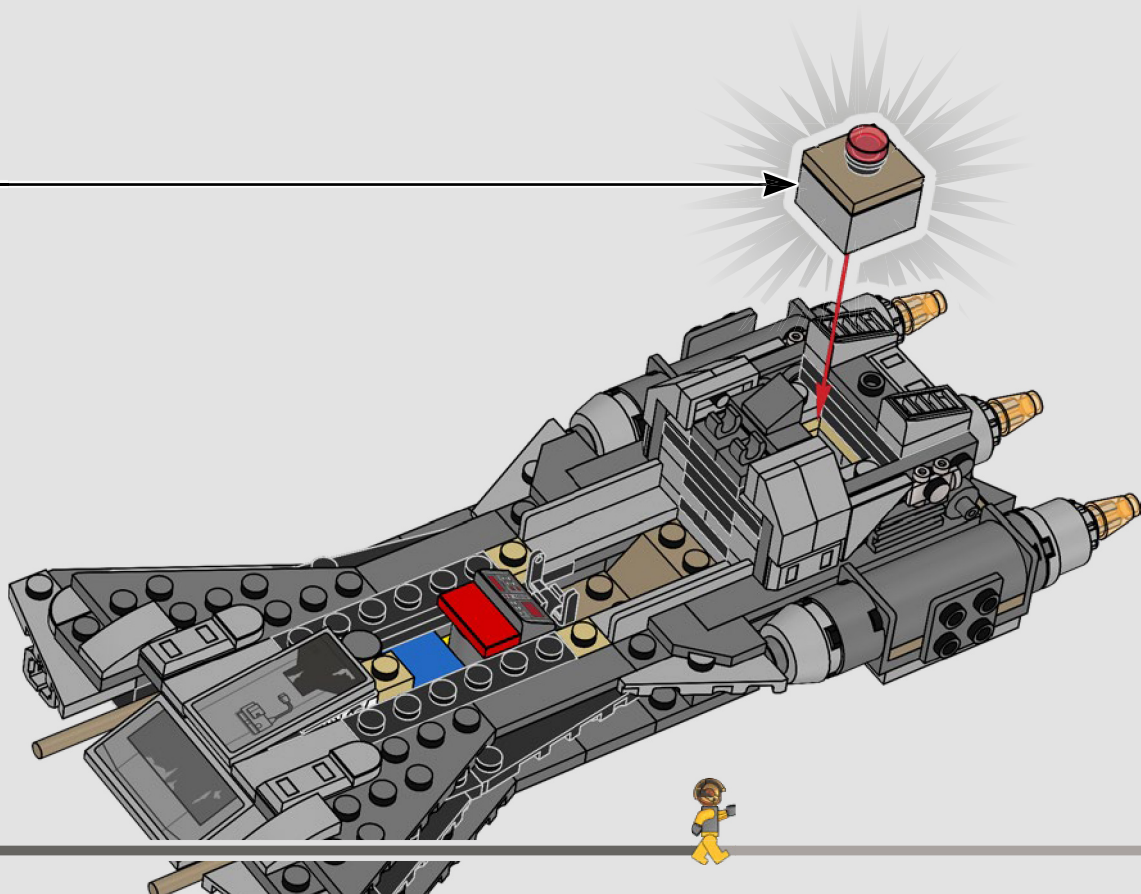

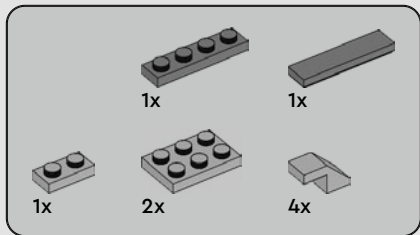

85

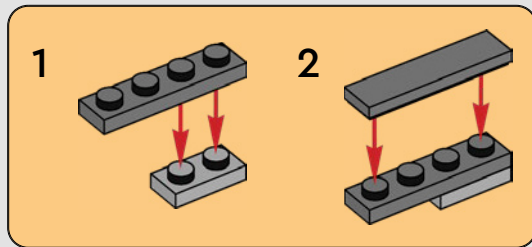
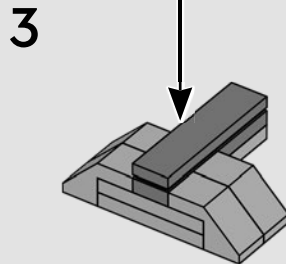
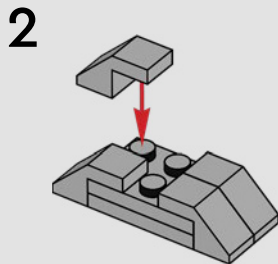
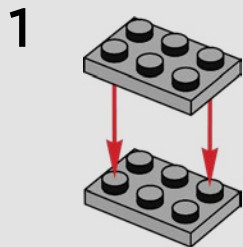

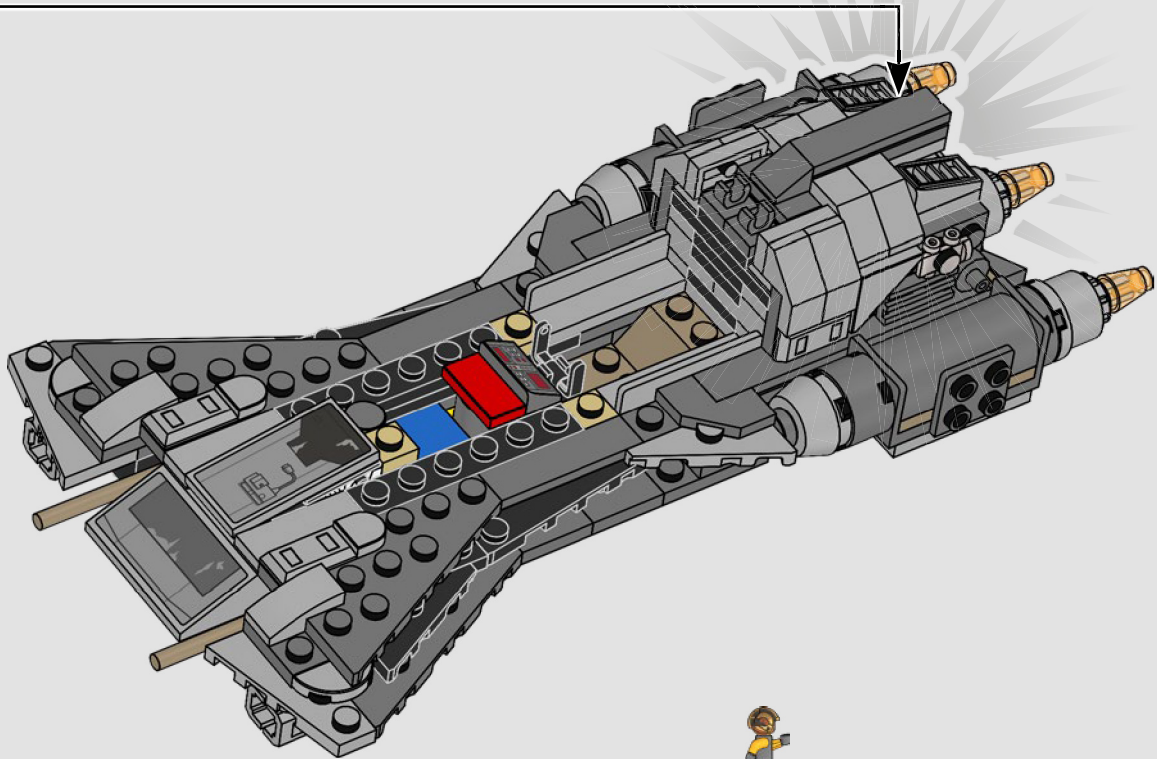

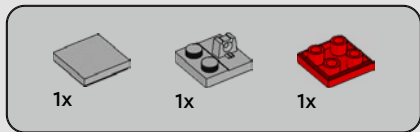

86

1



2

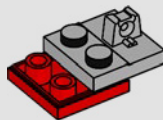

3

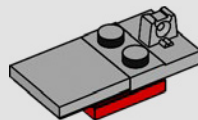

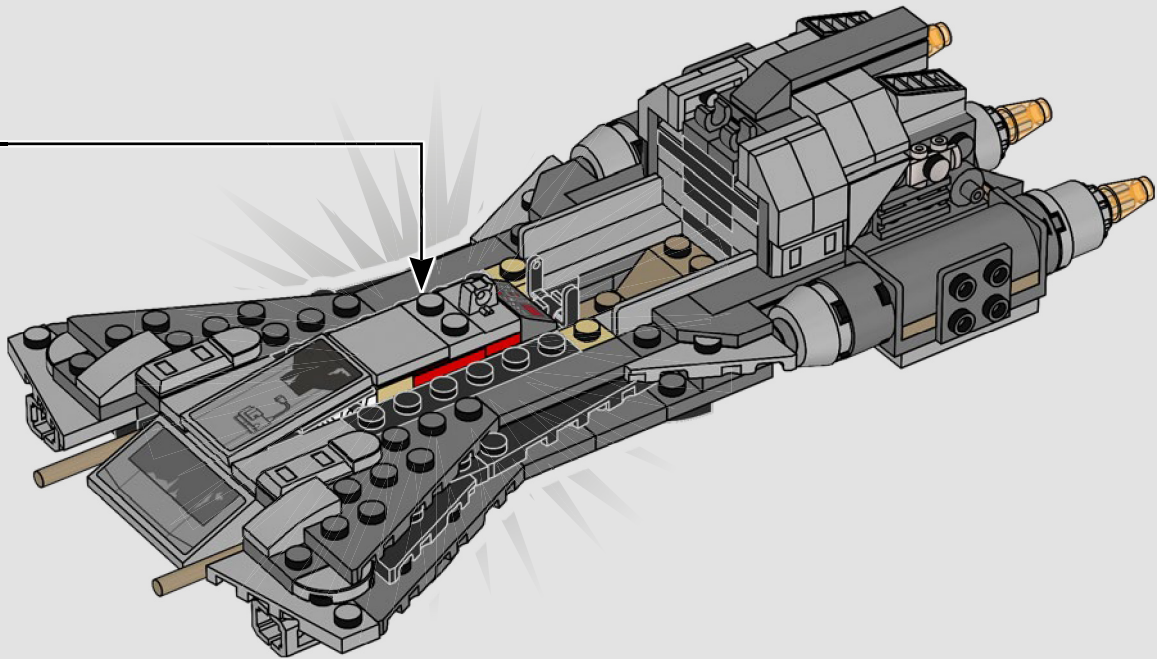



2x



2x



2x



2x



2x

87

1

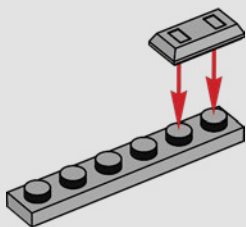

2

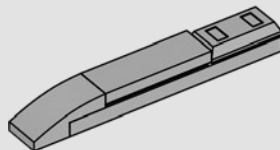

2x

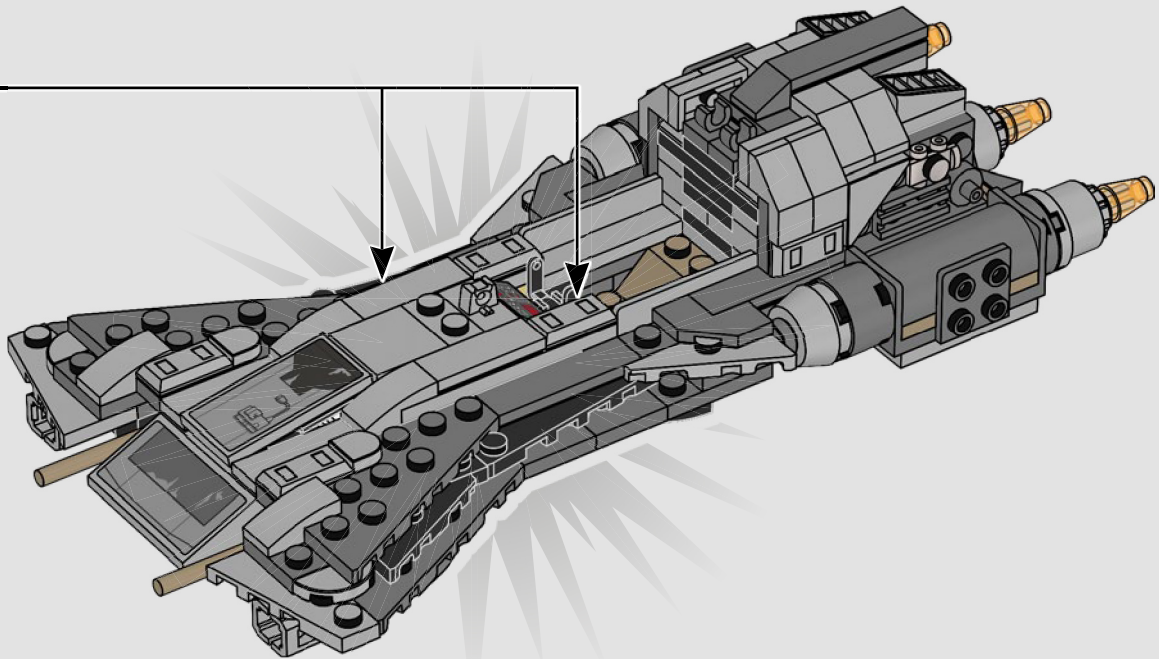



88

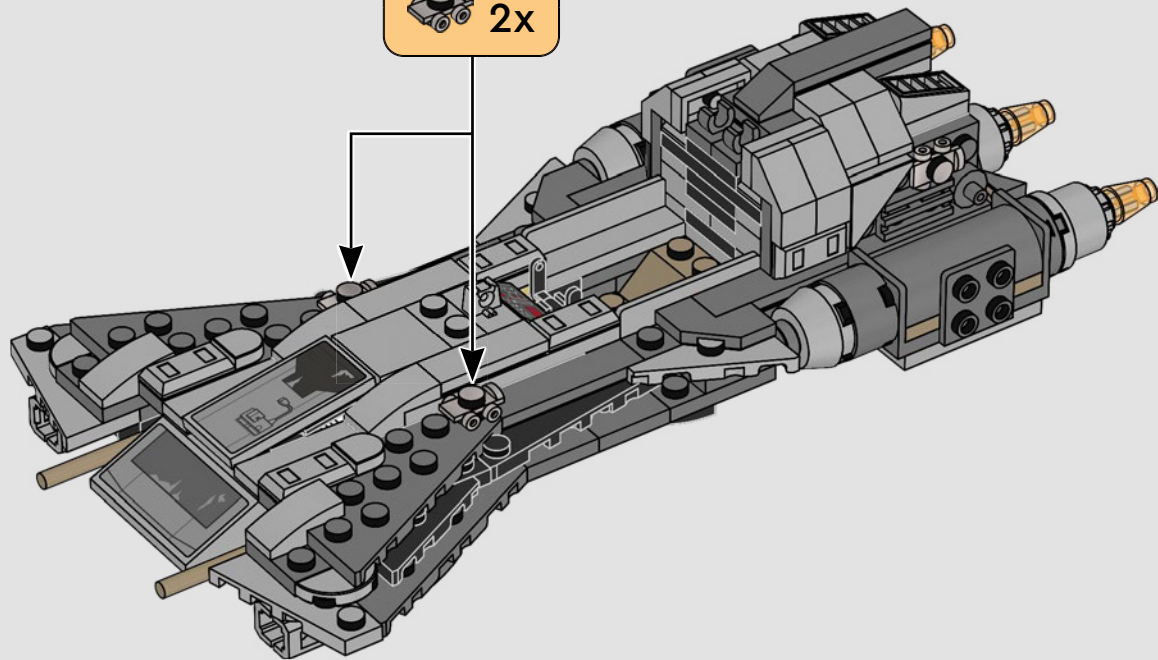



2x



4x



4x



2x

89

1



2

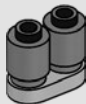

3



4



2x



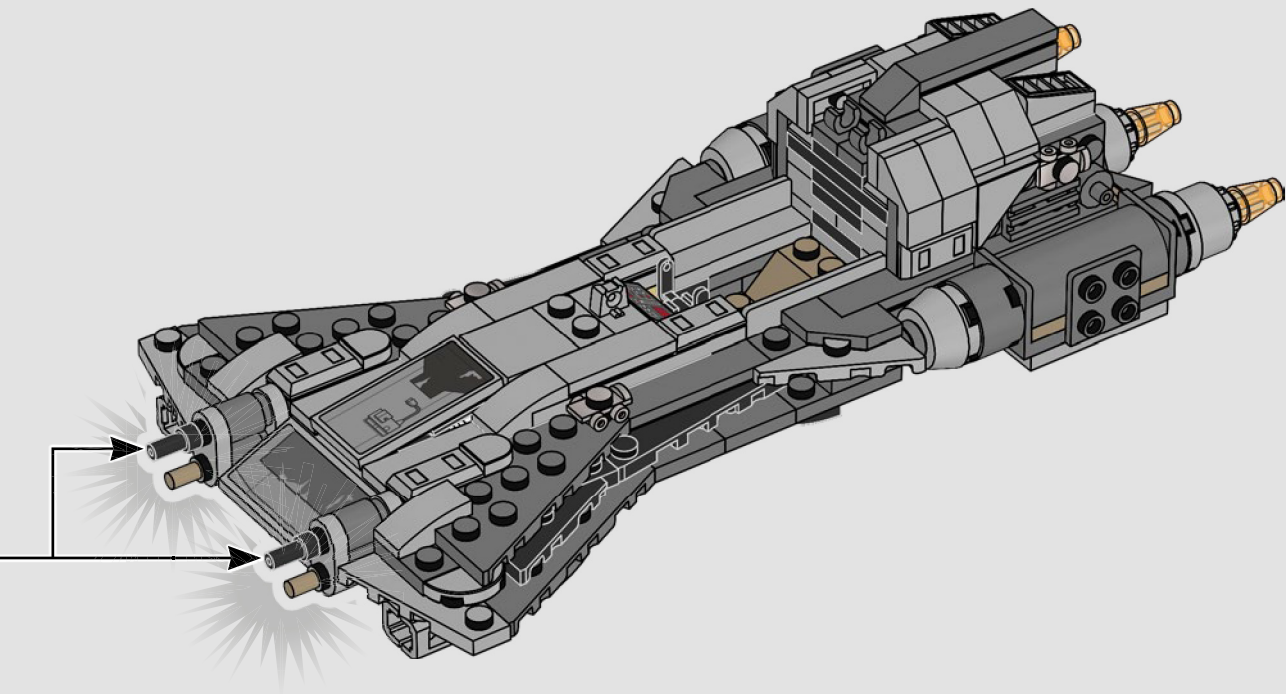



2x



2x

90



2x

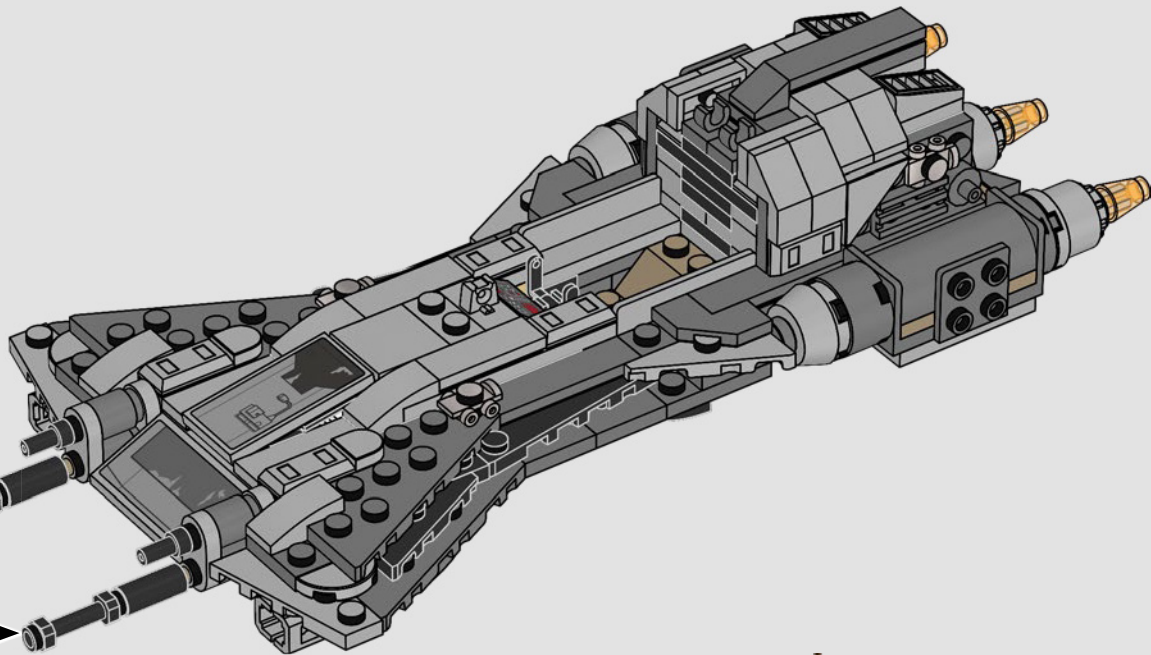

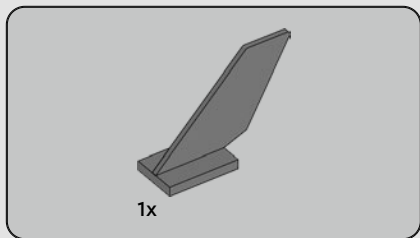

91

1

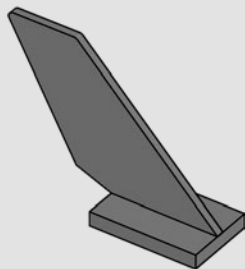

2

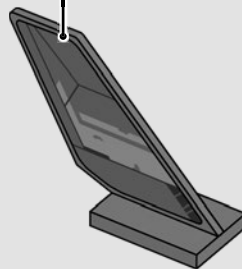

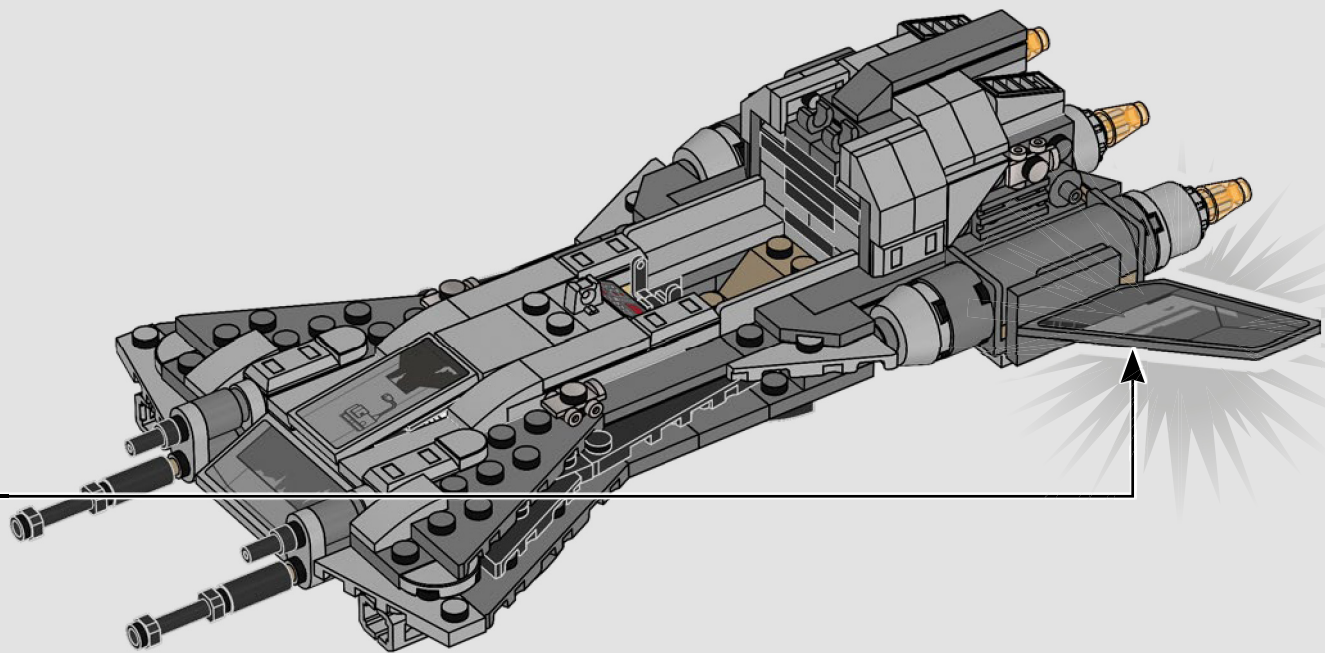

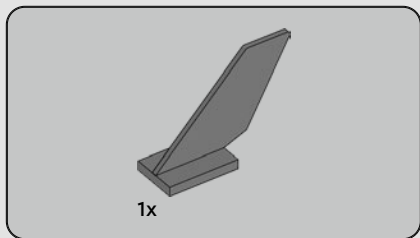

92

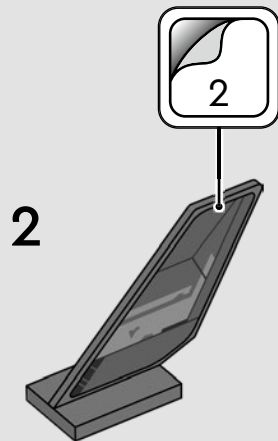
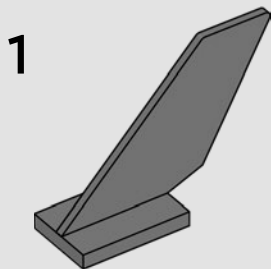

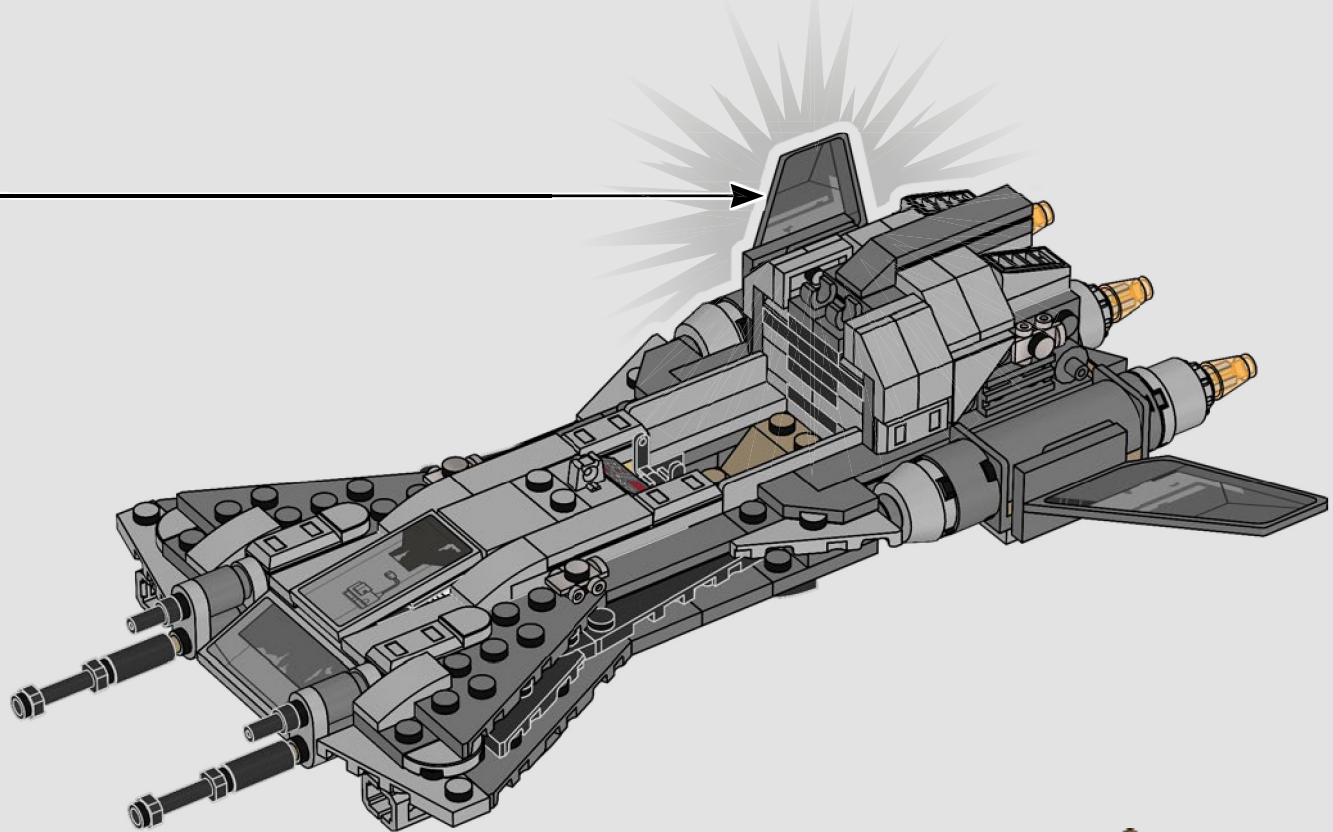

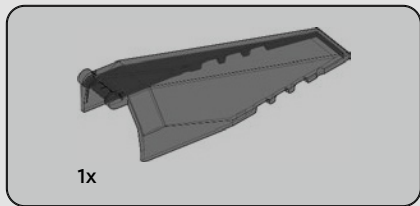

93

1

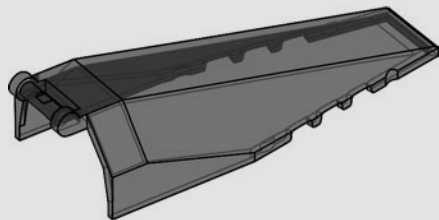

2

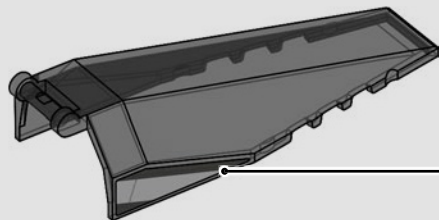

3

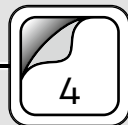
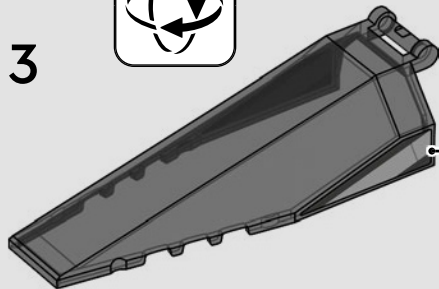

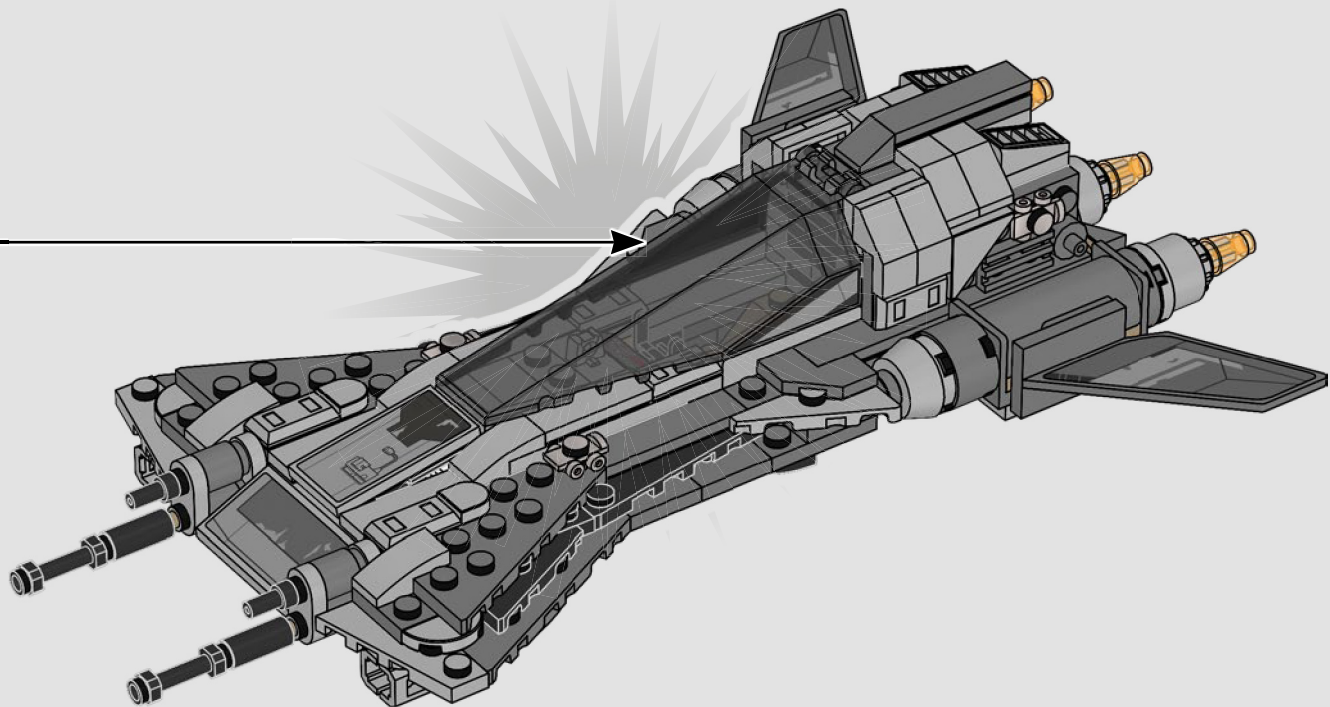



3x

94



2x

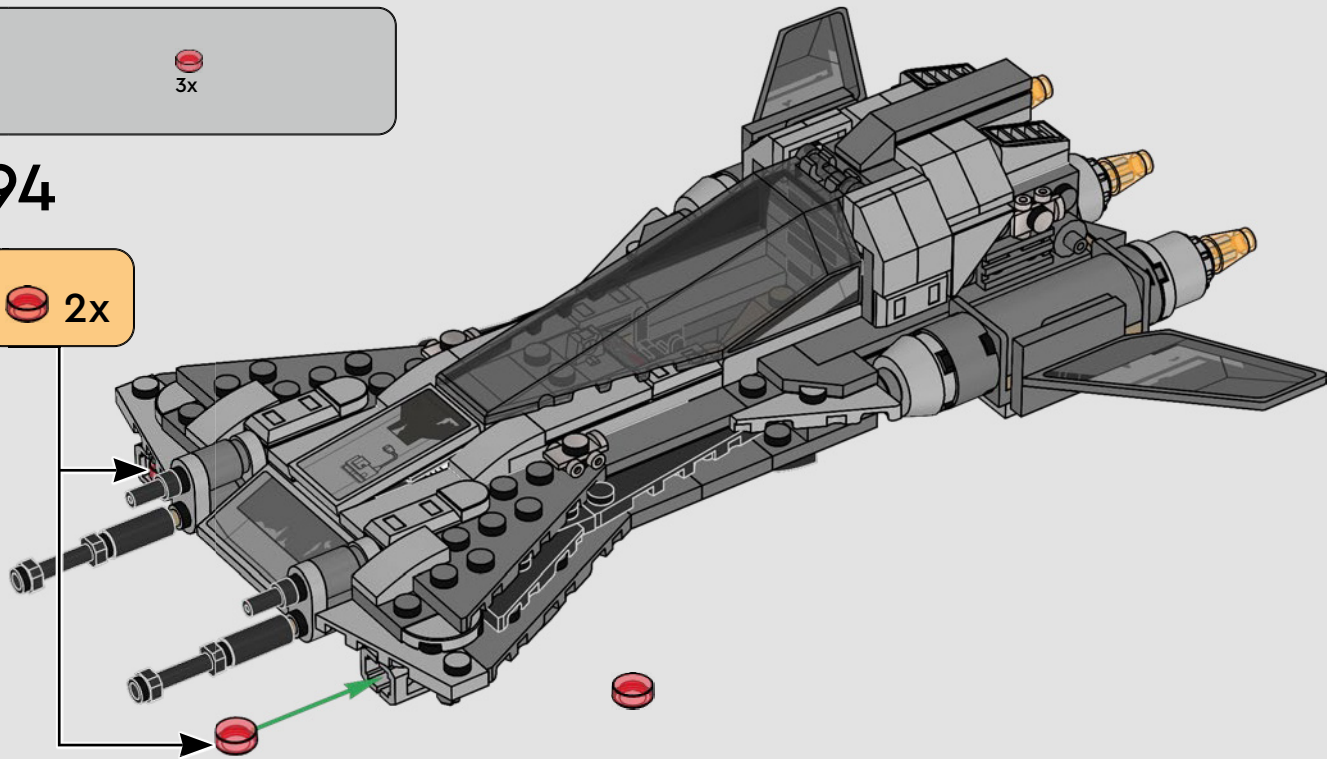

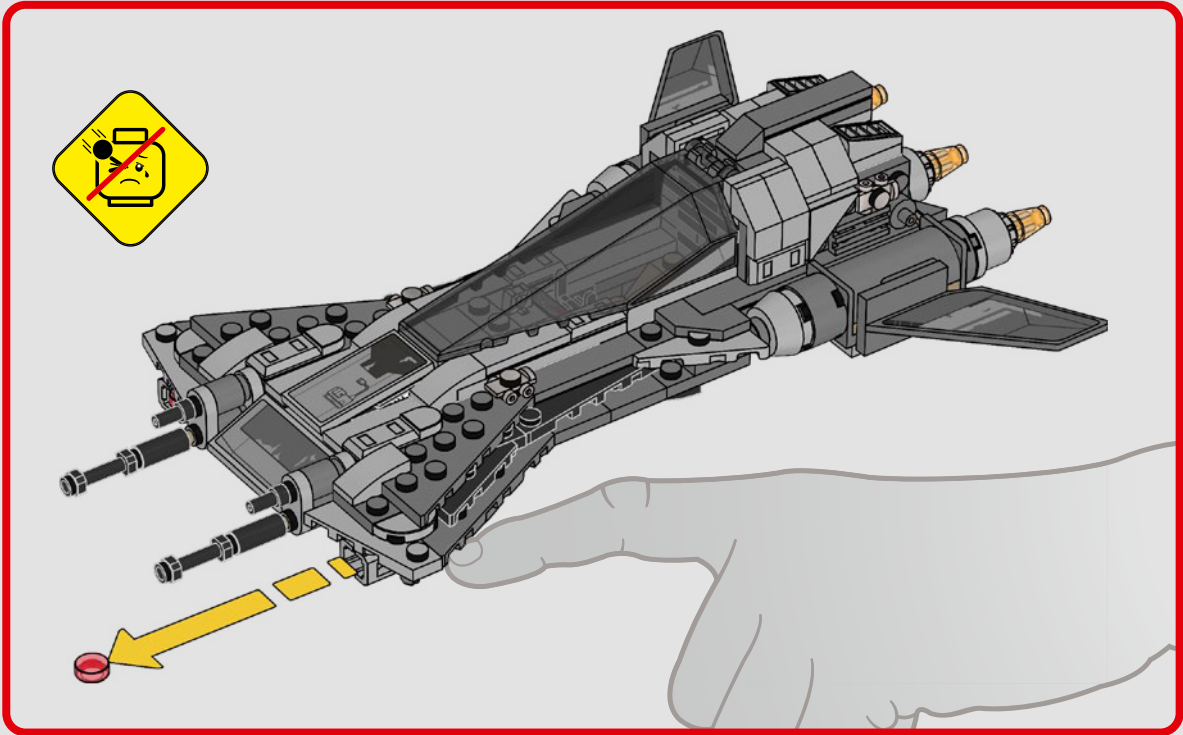

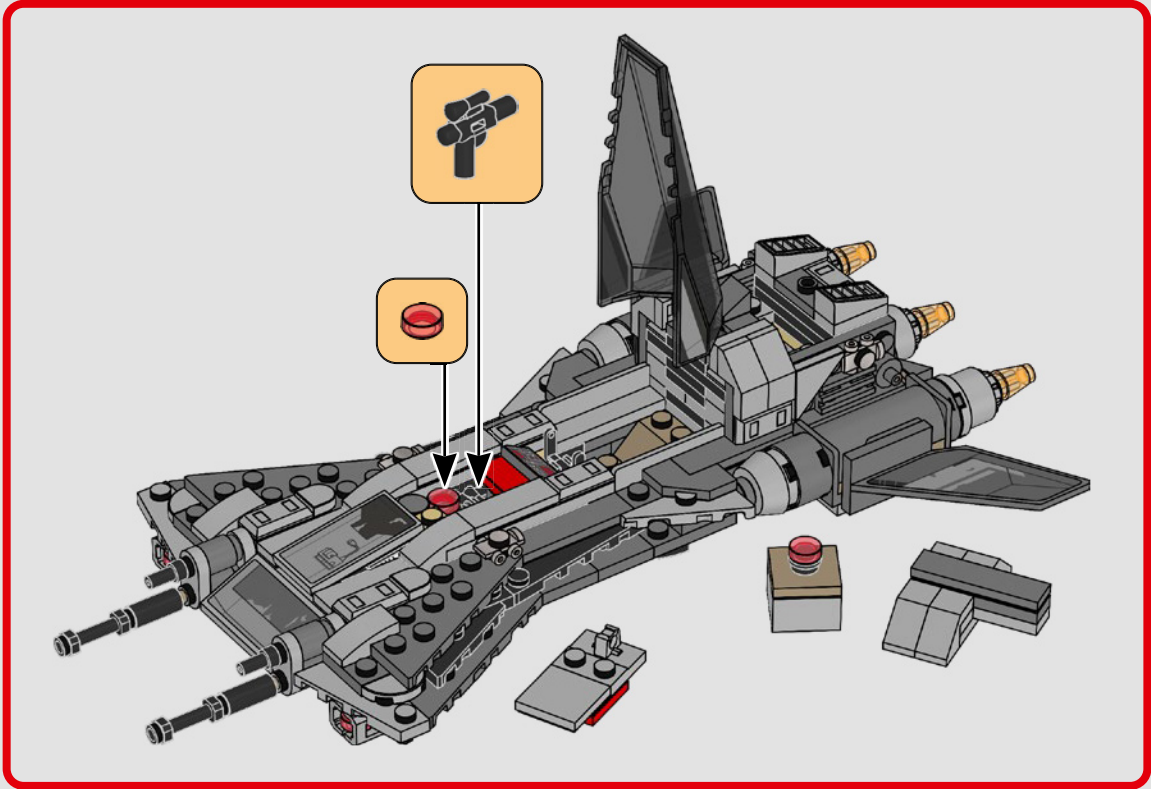

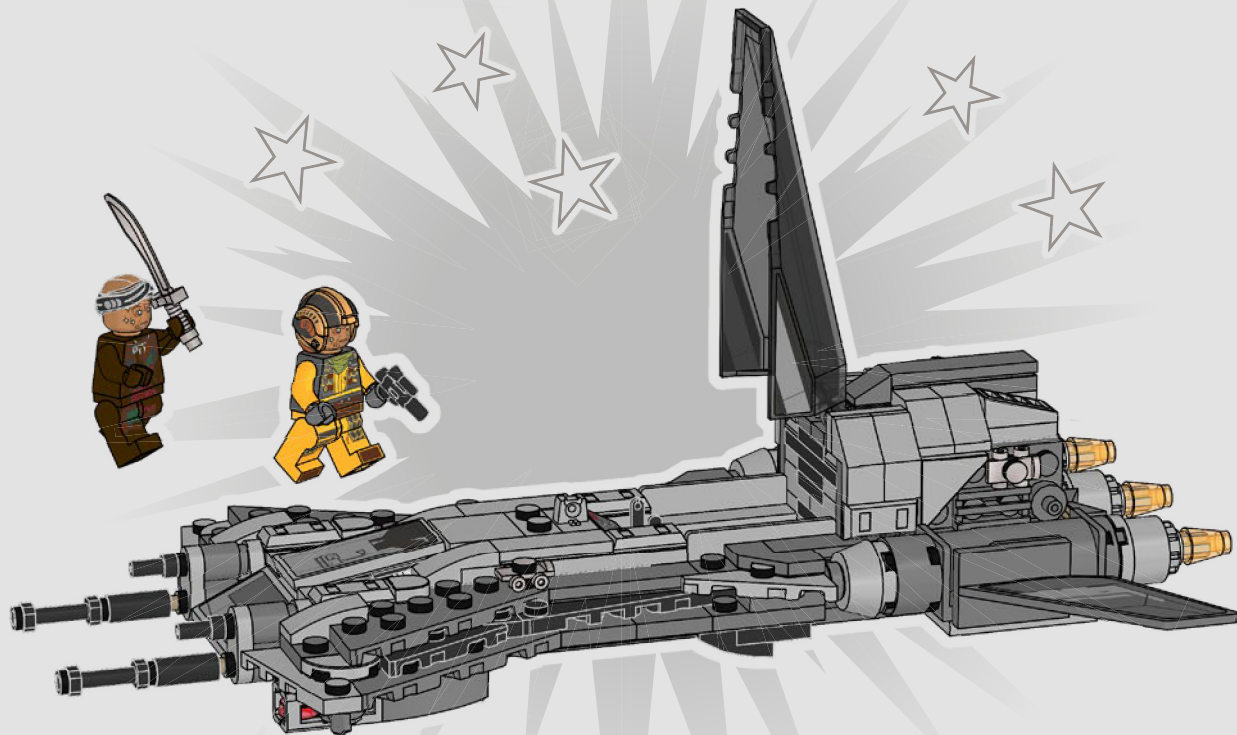



STAR WARS™



75348



75321



75324



75346

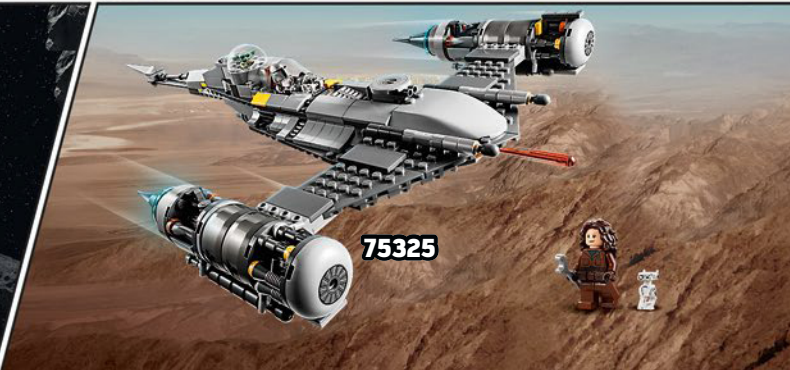

75325



Rebuild
the
world™



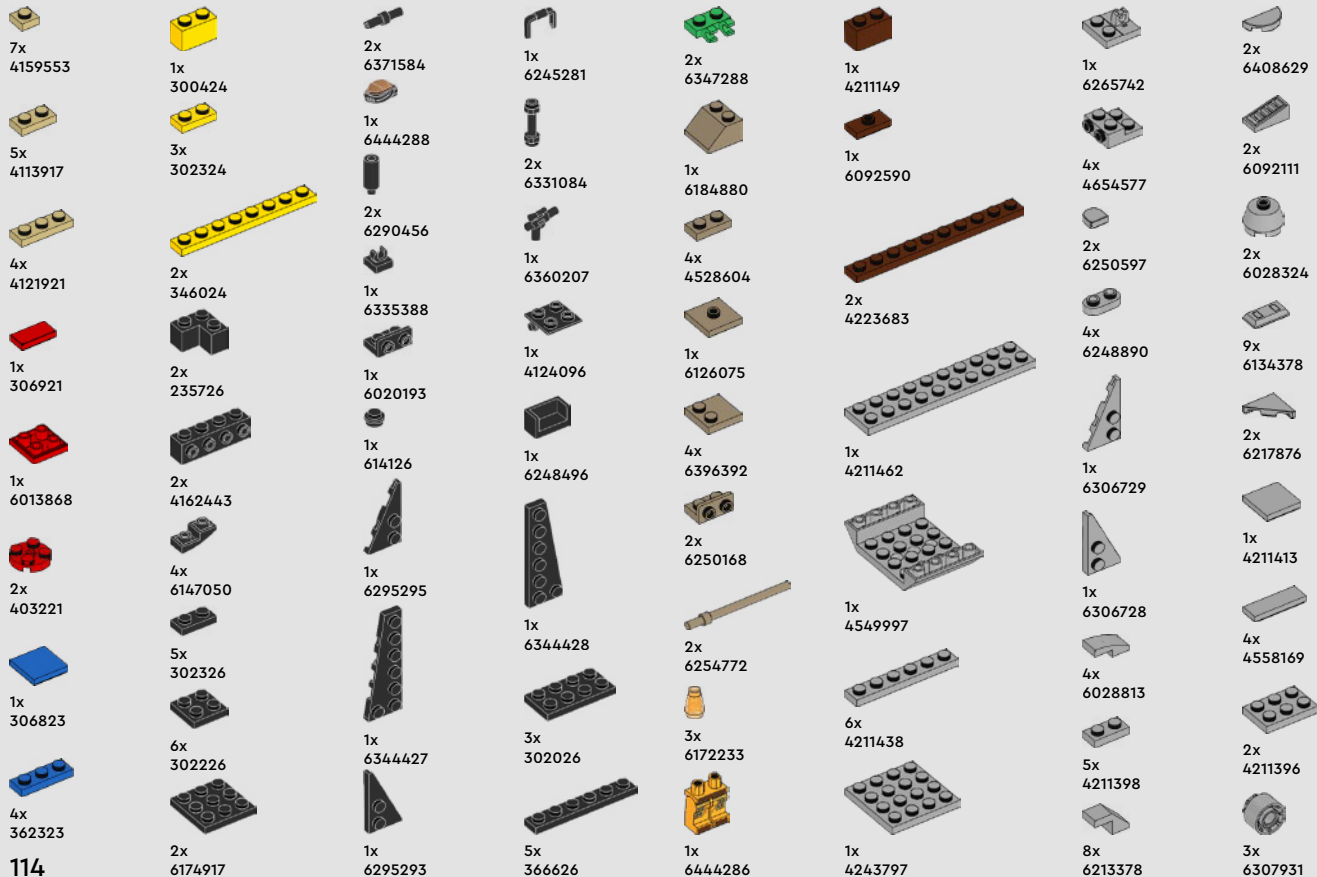

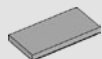

1x
4560183



4x
4211395



1x
4211420



1x
6435835



3x
6179186



1x
4211732



1x
4211735



2x
6071299



2x
6360382



3x
4211815



1x
6447672



1x
6444284



1x
6444283



1x
6446036



2x
6444281



4x
4211090



3x
4249139



5x
4504378



1x
6152814



2x
4246896

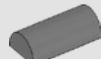

2x
4590786



3x
4658974



2x
6388133



2x
6092572



3x
4210631



6x
6309059



2x
6177079



5x
4211043



1x
4211001

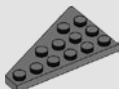

2x
6266298



2x
6360675



2x
6271752



2x
6344754



7x
6308045



3x
6284596



3x
4211042



2x
6266299

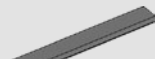

2x
4211008



2x
4210998



3x
4211053



2x
4211002



2x
6429075

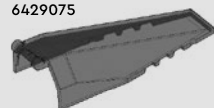

1x
6440101

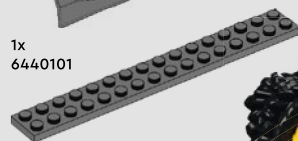

1x
4210796



3x
6360263



1x
393701



4x
6258607



1x
6287874



4x
6215447



1x
6172879



LEGO.com/service

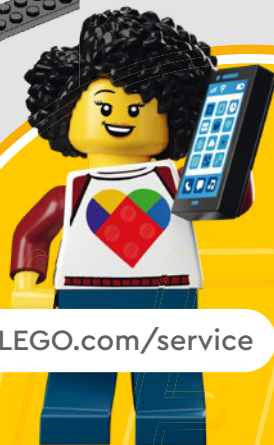

YOU COULD
WIN



Scan this QR code or go to
LEGO.COM/PRODUCTFEEDBACK and give us
your short feedback about this LEGO® set for
a chance to win a cool LEGO prize.

Terms and Conditions apply*

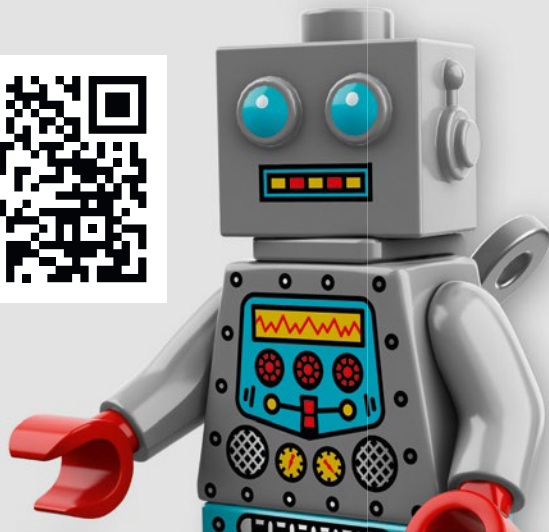

EN: YOU COULD WIN. Terms and Conditions apply* **DE: Du könntest GEWINNEN.** Es gelten die Teilnahmebedingungen* **FR: Tu pourrais GAGNER.** Des conditions s'appliquent* **IT: Potresti VINCERE tu.** Termini e condizioni sono applicabili* **ES: Puedes GANAR.** Aplican términos y condiciones* **PT: Poderá GANHAR.** Aplicam-se termos e condições* **ZH: 轻松获奖. 条款和条件适用*** **PL: Szansa na WYGRANĄ.** Obowiązują warunki korzystania* **CS: Máte šanci VYHRÁT.** Platí všeobecné smluvní podmínky* **SK: Máte šancu VYHRÁŤ.** Platia všeobecné zmluvné podmienky* **HU: TE IS NYERHETSZ.** Felhasználási feltételek érvényesek* **RO: Ai putea CÂȘTIGA.** Se aplică termeni și condiții* **BG: Можете да СПЕЧЕЛИТЕ.** Има определени правила и условия* **LV: Tu vari LAIMĒT.** Ir spēkā noteikumi un nosacījumi.* **ET: Sul on võimalus VÕITA.** Kehtivad tingimused* **LT: Jūs galite LAIMĖTI.** Taikomos sąlygos*

*[LEGO.com/productfeedback-terms](https://www.lego.com/productfeedback/terms)

LEGO and the LEGO logo are trademarks of the LEGO Group. ©2023 The LEGO Group.

© & ™ Lucasfilm Ltd.

6465878